



NANYANG PRIMARY SCHOOL
PRELIMINARY EXAMINATION
2012

PRIMARY 6
MATHEMATICS
PAPER 1

DURATION: 50 MINUTES

Booklet A	/ 20
Booklet B	/ 20

Paper 1 Total: / 40

Name: _____ ()

Class: Primary 6 ()

Date: 23 August 2012

Parent's Signature:

DO NOT OPEN THIS BOOKLET UNTIL YOU ARE TOLD TO DO SO.

FOLLOW ALL INSTRUCTIONS CAREFULLY.

ANSWER ALL QUESTIONS.

YOU ARE NOT ALLOWED TO USE A CALCULATOR.

PAPER 1 (BOOKLET A)

Questions 1 to 10 carry 1 mark each. Questions 11 to 15 carry 2 marks each. For each question, four options are given. One of them is the correct answer. Make your choice (1, 2, 3 or 4). Shade the oval (1, 2, 3 or 4) on the Optical Answer Sheet.

(20 marks)

1 Arrange the following numbers from the largest to the smallest.

34 899, 34 989, 34 909, 34 999

- (1) 34 899, 34 909, 34 989, 34 999
- (2) 34 899, 34 989, 34 909, 34 999
- (3) 34 999, 34 989, 34 899, 34 909
- (4) 34 999, 34 989, 34 909, 34 899

2 $248 + 303 = 999 - \boxed{?}$

The missing number in the box is _____.

- (1) 448
- (2) 551
- (3) 696
- (4) 751

3 Which one of the following pairs of numbers has 8 as a common factor?

(1) 12 and 16

(2) 12 and 20

(3) 16 and 20

(4) 16 and 24

4 In 934.825, what does the digit 2 stand for?

(1) 0.2 hundredths

(2) 0.2 tenths

(3) 0.2 ones

(4) 0.2 tens

5 Which one of the following is the closest estimate of 69.2×48.7 ?

(1) 2 400

(2) 2 800

(3) 3 000

(4) 3 500

- 6 A group of children was asked to name their favourite type of cake. The pie chart below shows their preferences.

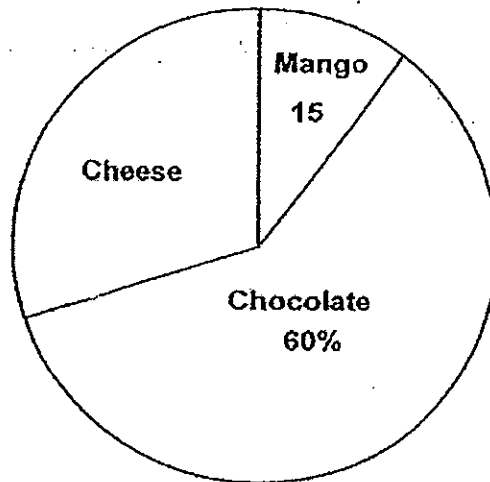

The number of children who liked chocolate cakes was 6 times the number of children who liked mango cakes. How many children liked cheesecakes?

- (1) 45
- (2) 60
- (3) 90
- (4) 150

7. In the figure below, XU, WZ, YO and VO are straight lines.
 $\angle YOX = \angle VOW = 90^\circ$.
 Which of the following 2 angles will not always add up to 90° ?

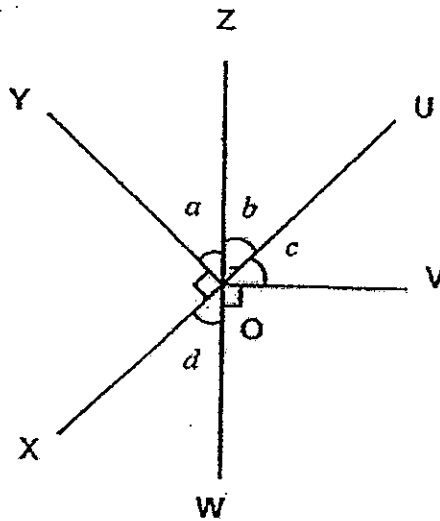

- (1) $\angle a$ and $\angle b$
- (2) $\angle a$ and $\angle c$
- (3) $\angle a$ and $\angle d$
- (4) $\angle c$ and $\angle d$

- 8 The figure below shows a cube with 3 printed sides. All faces are unshaded.

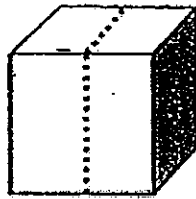

Which one of the following is a net of the cube?

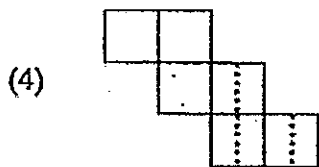
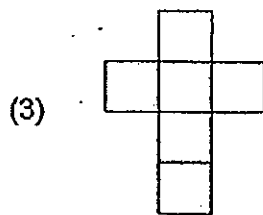
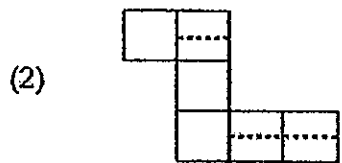
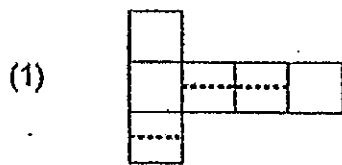

- 9 Simplify the following algebraic expression :

$$4h + 3 \times 12 + (12h + 3h) + 5h$$

(1) $\frac{1}{9}h + 3$

(2) $3\frac{1}{45}h$

(3) $16h + 3$

(4) $28\frac{3}{5}h$

- 10 Anna paid \$963, inclusive of a 7% GST, for a washing machine. What was the amount of GST that she paid?

(1) \$9

(2) \$63

(3) \$75

(4) \$900

- 11 A rope 14.56 m long was first cut into two pieces in the ratio of 2 : 5. The longer piece was then cut into two pieces in the ratio of 2 : 3. Find the length of the longest piece after the two cuts.

- (1) 4.16 m
- (2) 6.24 m
- (3) 8.40 m
- (4) 10.4 m

- 12 The areas of three faces of the cuboid below are 24 cm^2 , 16 cm^2 and 6 cm^2 . Find the volume of the cuboid.

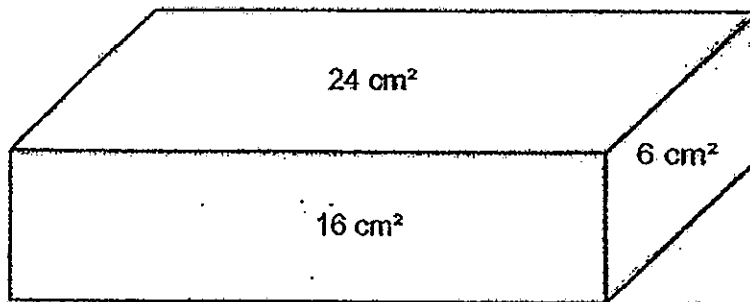

- (1) 32 cm^3
- (2) 48 cm^3
- (3) 72 cm^3
- (4) 192 cm^3

13 How many cubes of volume 8 cm^3 are needed to build a cuboid measuring 24 cm by 8 cm by 16 cm?

- (1) 6
- (2) 384
- (3) 3072
- (4) 24 576

14 Gerry has more stickers than Mary. The ratio of the total number of stickers both have to the difference between the number of stickers each of them have is 13 : 3. Express the number of stickers Gerry has as a fraction of the number of stickers Mary has.

- (1) $\frac{13}{10}$
- (2) $\frac{8}{5}$
- (3) $\frac{10}{3}$
- (4) $\frac{13}{3}$

15 The picture below shows the landmarks of the Botanic Gardens.

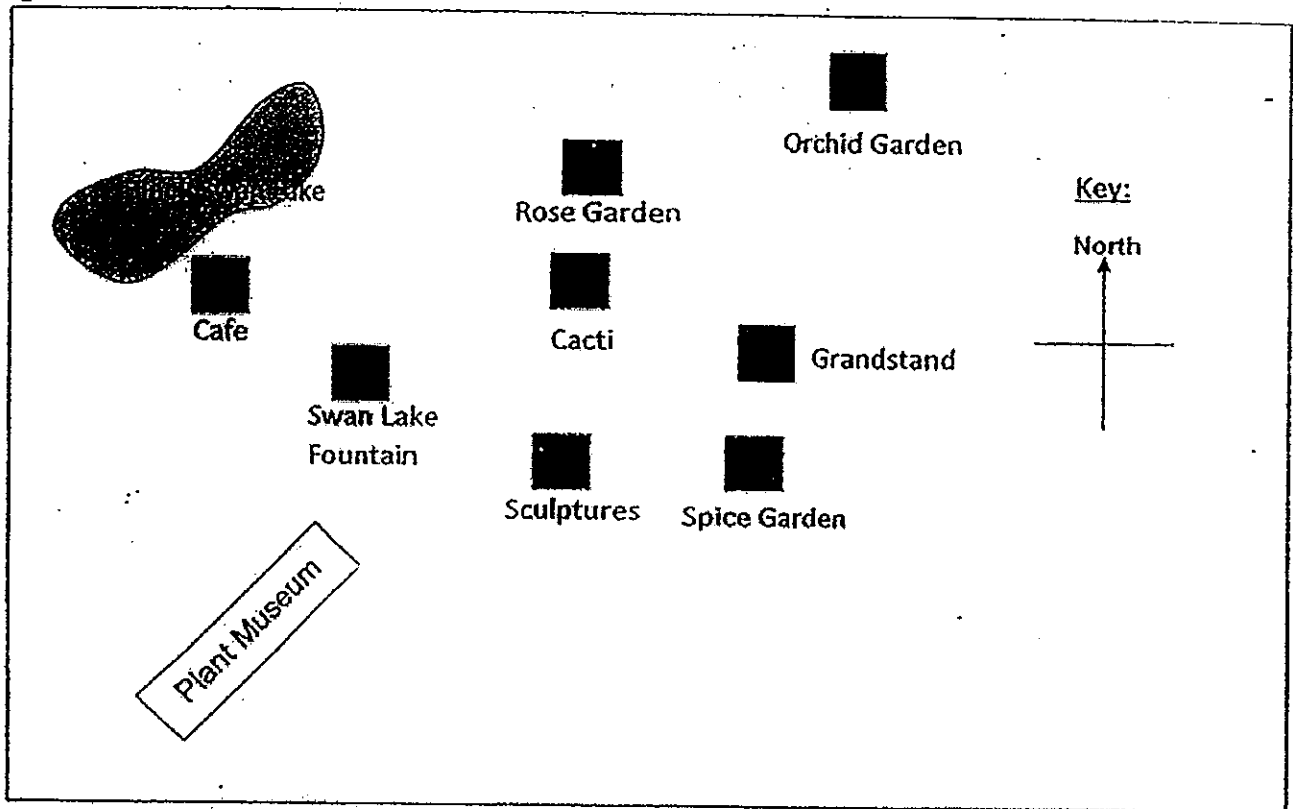

From where John was standing as he was reading his map, he realised that the Orchid Garden was on his northeast and the Plant Museum was on his southwest. What landmark was on his southeast?

- (1) Grandstand
- (2) Sculptures
- (3) Spice Garden
- (4) Swan Lake Fountain

Name: _____ () Class: Pr 6 ()

P6 Prelims 2012

PAPER 1 (BOOKLET B)

Questions 16 to 25 carry 1 mark each. Write your answers in the spaces provided. For questions which require units, give your answers in the units stated.

(10 marks)

-
- 16 Kathy mixed 1.5ℓ of syrup with 6ℓ of water. She then poured the mixture equally into 25 glasses. How much mixture was there in each glass? Express your answer in millilitres.

Answer: _____ ml

-
- 17 Find the value of $8\frac{2}{7} - 2\frac{5}{14}$.
Express the answer in the simplest form.

Answer: _____

-
- 18 Find the value of $18 \times 7\frac{2}{9}$.

Answer: _____

19 Find the value of $12.24 \div 6$ Leave your answer as a decimal.

Answer: _____

20 Chilli Crab Seafood Restaurant opens every day during the time shown in the table below;

Opening hours Lunch : 11.30 a.m. to 3.00 p.m. Dinner : 6.30 p.m. to 3.30 a.m.

How many hours and minutes does the restaurant open each day?

Answer: _____ h _____ min

21 What is 20.04 litres in millilitres?

Answer: _____ ml

- 22 In the figure below, BCDE is a rhombus and DEA is a straight line. Find the value of $\angle b$.

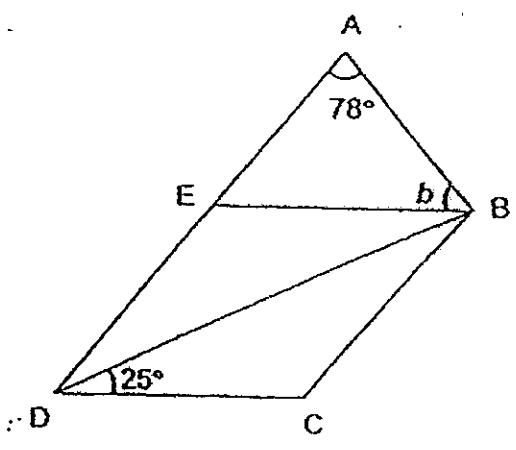

Answer: _____

- 23 The figure below is made up of equilateral triangles. Shade 2 more triangles so that the figure has three lines of symmetry.

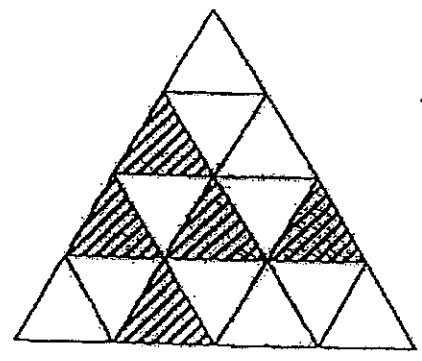

- 24 During a recent Science Test, the ratio of Julia's marks to Lynn's marks is 6 : 7. Lynn scored 5 marks more than Julia. What was Julia's marks?

Answer: _____

- 25 Lee Hui swam a total of 1 km when she was training for a competition. She took 1250 s to cover 1 km. What was her average speed? Give your answer in m/s.

Answer: _____ m/s

Questions 26 to 30 carry 2 marks each. Show your working clearly in the space provided for each question and write your answers in the spaces provided. For questions which require units, give your answers in the units stated.

(10 marks)

- 26 Ali ate $\frac{1}{4}$ of a cake. He cut the remaining cake into a number of equal pieces. Each piece was $\frac{1}{12}$ of the cake. How many equal pieces did Ali cut the remaining cake into?

Answer: _____

- 27 The ratio of the length to the breadth of a rectangle is 3 : 2. The area of the rectangle is 600 cm². Find its length.

Answer: _____ cm

- 28 The pattern in the box shows part of a tessellation. Extend the tessellation by drawing two more unit shapes in the space provided within the box.

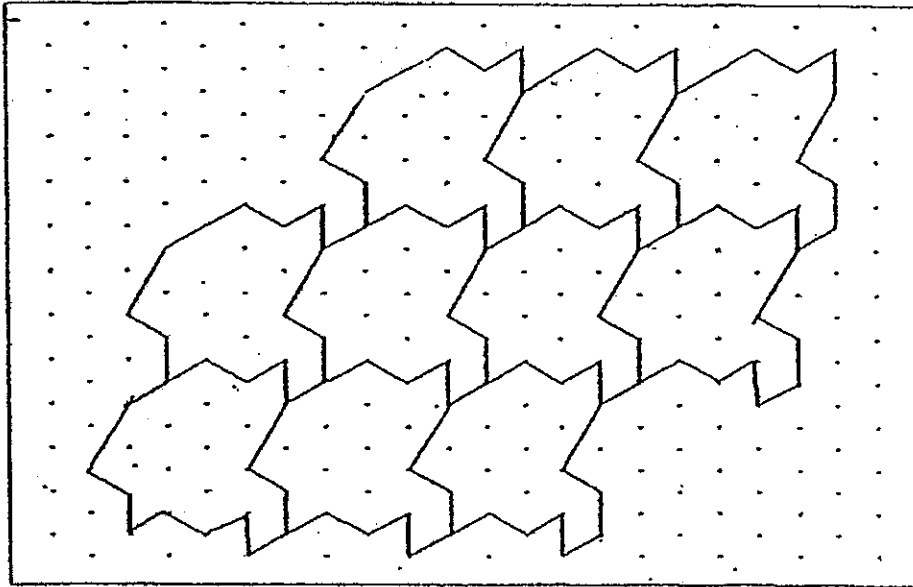

- 29 The table below shows the number of each type of coins that Debbie has in her piggy bank.

Type of coins	10¢	20¢	50¢
Number of coins	69		45

She has a total of \$36.60 in her piggy bank. How many 20¢ coins does she have?

Answer: _____

- 30 Mary made $(20y + 2)$ rice dumplings. She gave 4 rice dumplings to each of her sisters and had $4y$ rice dumplings left. How many sisters did Mary have?

Answer: _____

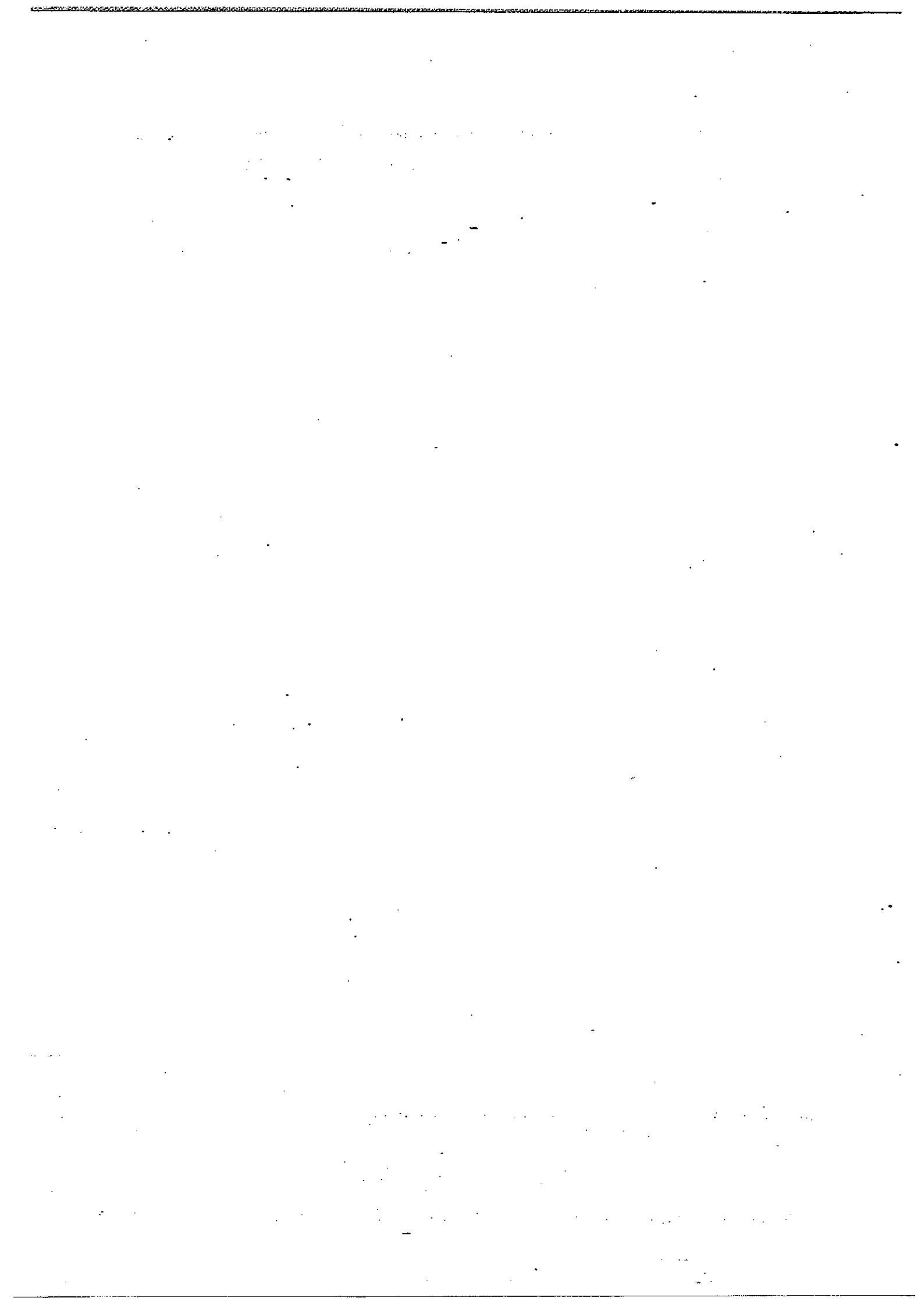



NANYANG PRIMARY SCHOOL
PRELIMINARY EXAMINATION
2012

PRIMARY 6
MATHEMATICS
PAPER 2

DURATION: 1 HOUR 40 MINUTES

Paper 2 Total	/ 60
GRAND TOTAL	/ 100

Name: _____ ()

Class: Primary 6 ()

Date: 23 August 2012

Parent's Signature: _____

DO NOT OPEN THIS BOOKLET UNTIL YOU ARE TOLD TO DO SO.

FOLLOW ALL INSTRUCTIONS CAREFULLY.

ANSWER ALL QUESTIONS.

YOU ARE ALLOWED TO USE A CALCULATOR.

PAPER 2

Questions 1 to 5 carry 2 marks each. Show your working clearly in the space provided for each question and write your answers in the spaces provided. For questions which require units, give your answers in the units stated.

(10 marks)

- 1 Aisha bought 12 mangoes which were sold at 3 for \$10. She then used her remaining amount of money to buy 12 oranges which were sold at 4 for \$5. How much money did she have at first?

Answer: \$ _____

- 2 In the figure below, the area of the square ABDE is 100 cm^2 . Line FC is parallel to Line AB. The ratio of the shaded parts to the unshaded part is 1 : 3. Find the area of the unshaded part.

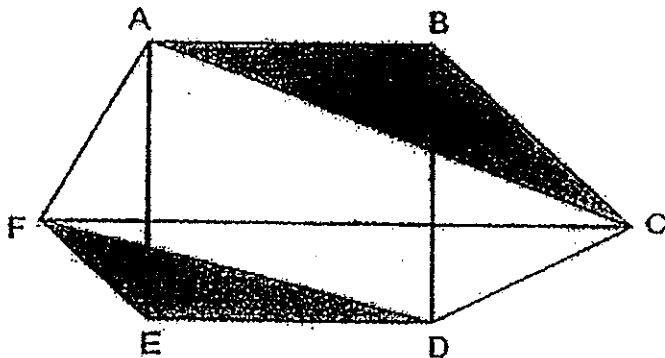

Answer: _____ cm^2

- 3 For every pack of 5 sweets, you get p sweets free. The sweets cost \$3 for a pack. ~~How much do you have to pay for a total of 20 sweets?~~
The sweets are only sold in packets. How many sweets can you get with \$20.

Answer:

- 4 Due to the rise in the cost of fuel, an airline has raised the price of the air tickets from \$395 to \$440. What was the percentage increase in the price of the air ticket? Give your answer correct to the nearest percent.

Answer: _____ %

- 5 The average of 5 odd numbers is 19. The average between the largest and the smallest number is also 19. What is the sum of the remaining 3 numbers?

Answer: _____

For questions 6 to 18, show your working clearly in the space provided for each question and write your answers in the spaces provided.

The number of marks available is shown in brackets [] at the end of each question or part-question.

(50 marks)

-
- 6 In a quiz, Wei Liang had to answer 20 multiple choice questions. For every correct answer, he would be awarded 3 marks but for every wrong answer, 1 mark would be deducted. Wei Liang answered all the questions and was awarded 36 marks. How many questions did he answer wrongly?

Answer: _____ [3]

-
- 7 Richard went to the money changer to exchange 900 Singapore Dollars for Hong Kong Dollars. At the counter, he saw the table shown below:

1 Singapore Dollar	=	0.79 US Dollar
1 Hong Kong Dollar	=	0.13 US Dollar

What was the amount of Hong Kong Dollars that he exchanged for, correct to the nearest dollar?

Answer: _____ [3]

- 8 Construct a rhombus ABCD below such that $\angle ADC$ is 65° and AD is 6 cm. [3]

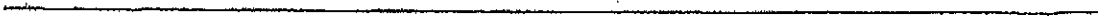
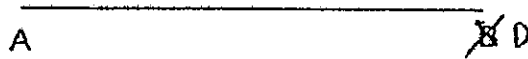

- 9 Keegan drew up a bar graph based on the amount of time he spent on each of the activities in 1 week.

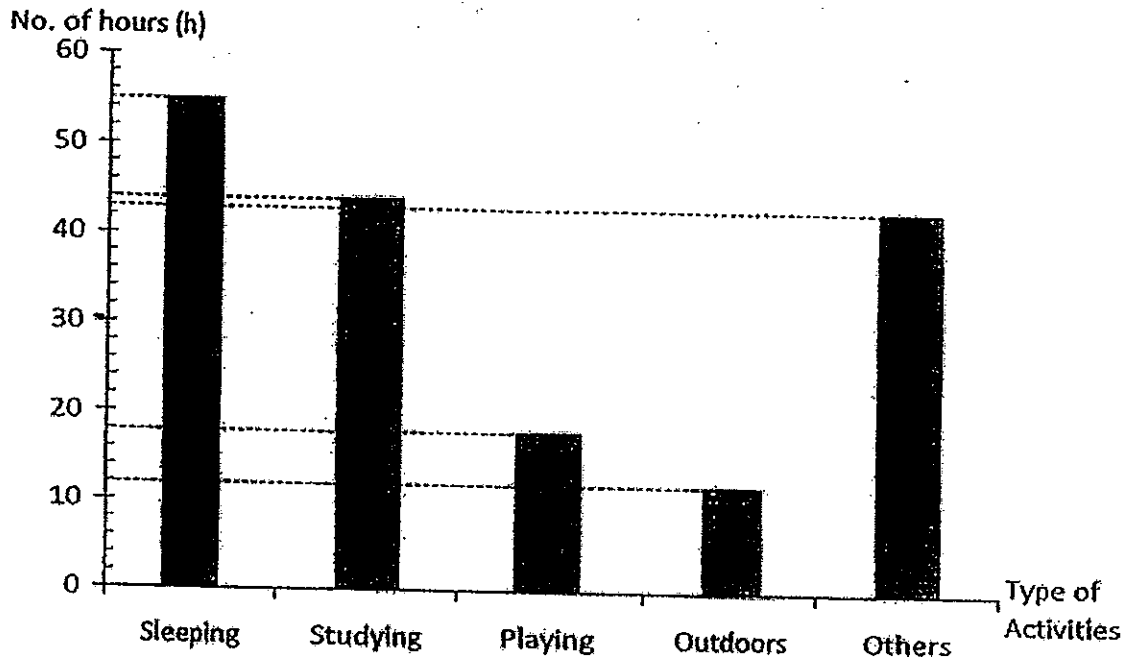

- a) After totalling up the number of hours that he had recorded in the graph for that week, he realised that he had recorded the time spent on one of the activities wrongly. The time recorded was 10% more than the actual time for that activity. Which activity did he record wrongly?
- b) What was the actual time taken for the activity that was recorded wrongly in (a)?

Answer: (a) _____ [2]
(b) _____ [2]

- 10 Tom started running from Point X in a clockwise direction and John started running from Point Y in an anti-clockwise direction on a 400 m track as shown in the figure below. They started running from directly opposite ends of the track at the same time. Tom ran at an average speed of 160 m/min while John ran at an average speed of 200 m/min. How far would Tom have run by the time they passed each other the second time on the track? Give your answer as a mixed number in the simplest form.

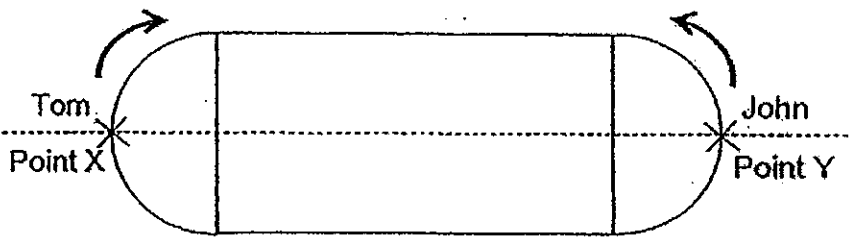

Answer: _____ [3]

- 11 The figure below shows an empty open-top metal tank. The external dimensions of the tank are 62 cm by 25 cm by 41 cm. There is an equal thickness of the metal 1.5 cm all around the tank. Water flows from a tap into the tank at a rate of $34 \text{ cm}^3/\text{s}$ for half an hour. Find the volume of water that overflowed.

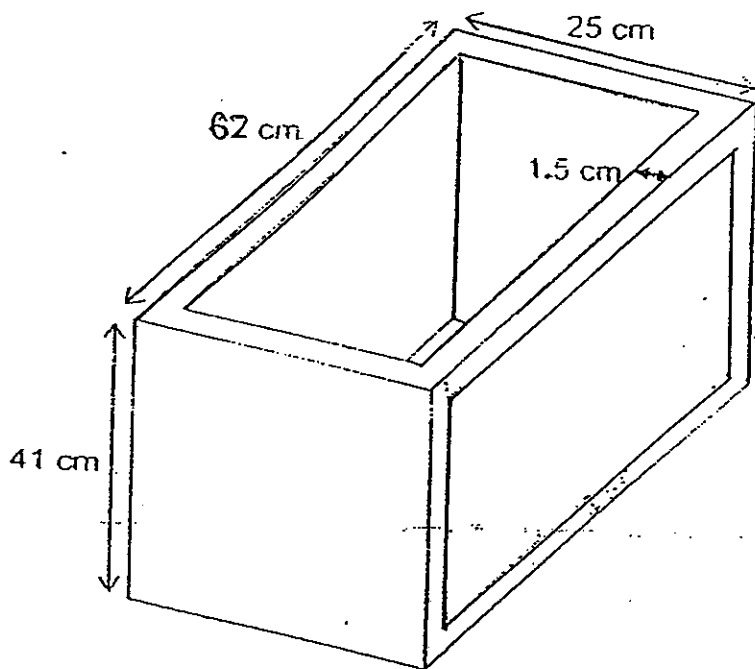

Answer: _____ [4]

- 12 In the figure below, ABCD is a square CDF is an equilateral triangle AF is a straight line. Find
- $\angle AFC$
 - $\angle BEC$

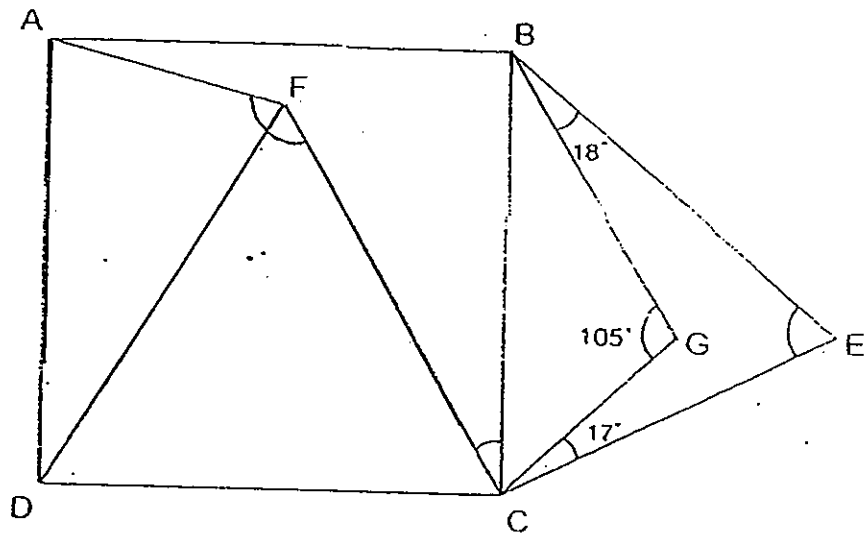

Answer: (a) _____ [2]
 (b) _____ [2]

13 Both shops, ABC and XYZ, offered a 15% discount for the same type of mattress. If Mr Muthu were to buy from Shop XYZ, he would have paid \$38.25 less than the discounted price in Shop ABC.

- a) What was the difference in the original price of the mattress between the two shops?
- b) The original price of the mattress in Shop ABC was \$1510. What was the minimum percentage discount it must offer so that the discounted price in Shop ABC would be lower than the discounted price in Shop XYZ? Give your answer correct to the nearest percent.

Answer: (a) _____ [2]

(b) _____ [2]

- 14 Figures A and B below are each formed by overlapping 7 circular rings of radius 10 m each. The ring in the middle in both figures passes through the centres of the 6 outer rings.

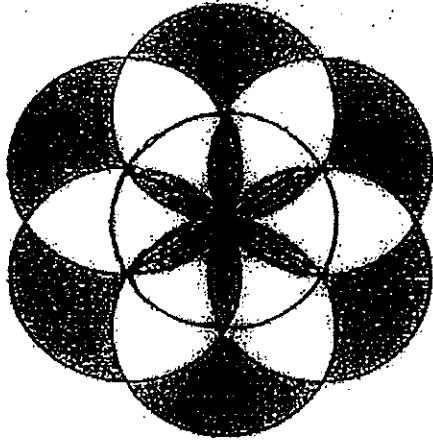

Figure A

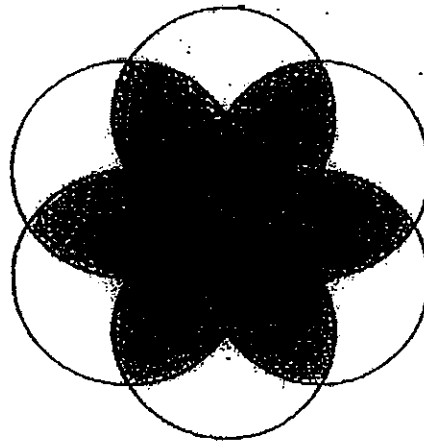

Figure B

Use the calculator value of π to find the total area of the shaded regions in both figures, correct to 2 decimal places.

Answer: _____ [4]

15. A photo album was made up of single sheets of plastic which were folded into half to create four pages of the album. Each page was able to hold 2 photos.

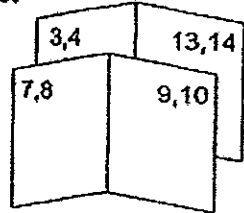

Figure 1

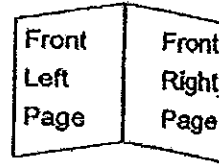

Figure 2

To make an album for 16 photos, we would need 2 sheets of plastic folded as shown in Figure 1 above. The middle of this album held photos with photo number 7, 8, 9 and 10.

- a) What were the photo numbers of the photos found in the middle of an album made from 3 sheets of plastic?
- b) A sheet of plastic was removed from an album, X, which was made up the same way as the photo album above. Photos with photo numbers 23, 24, 49 and 50 were found on the front left and right pages as shown in Figure 2.
 - i) What were the photo numbers of the photos found at the back of this sheet of plastic?
 - ii) How many photos were there in Album X at first?

Answer: (a) _____ [1]

(bi) _____ [1]

(ii) _____ [2]

16 Last month, May spent $\frac{1}{4}$ of her income on transport, $\frac{9}{20}$ on food and saved the rest. Her income was increased by $\frac{1}{10}$ in this month. She spent the same amount on transport but increased her savings by 30%. She saved \$780 this month.

- a) How much did she spend on transport?
- b) How much did she spend on food this month?

Answer: (a) _____ [2]

(b) _____ [3]

- 17 Four children decided to find out their total mass. As they did not want their friends to know their individual mass, the children decided to weigh themselves 3 persons at a time. Although the children tried all possible ways of grouping themselves into threes for weighing, only four different readings were repeatedly recorded on the weighing scale.

99.5 kg	108.1 kg	111.7 kg	116.3 kg
---------	----------	----------	----------

Find the combined mass of the heaviest child and the lightest child.

Answer: _____ [5]

- 18 At a swimming meet, School A had 18 more representatives than School B and 6 fewer representatives than School C. The ratio of the number of boys to girls from the three schools was 1 : 3. The ratios of the number of boys to the number of girls in Schools A, B and C were 1 : 3, 1 : 5 and 2 : 5 respectively. How many representatives from the three schools were there in all?

Answer: _____ [5]

END OF PAPER

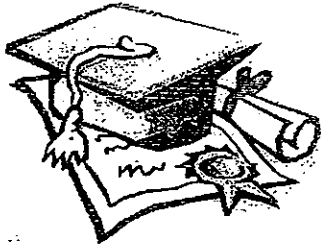

ANSWER SHEET

EXAM PAPER 2012

SCHOOL : NANYANG Primary School
SUBJECT : PRIMARY 6 MATHS

TERM : SA2

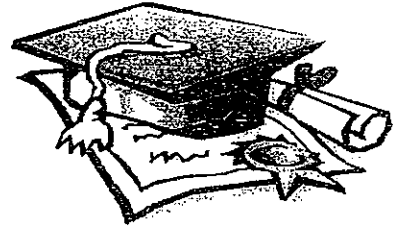

Paper 1

Q1	Q2	Q3	Q4	Q5	Q6	Q7	Q8	Q9	Q10	Q11	Q12	Q13	Q14	Q15
4	1	4	2	4	1	2	4	3	2	2	2	2	2	3

- 16 300ml
- 17 $5 \frac{13}{14}$
- 18 130
- 19 2.04
- 20 12h 30min
- 21 20040ml
- 22 52°
- 23

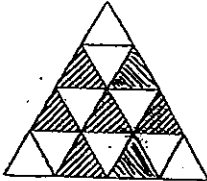

- 24 30
- 25 0.8m/s
- 26 $0.25 \div \frac{1}{12}$
- 27 Let the length be $3x$ and breath be $2x$
 $3x \times 2x = 6x^2$
 $6x^2 = 600$
 $x^2 = 100$
 $x = 10\text{cm}$
Length = $3x = 30\text{cm}$

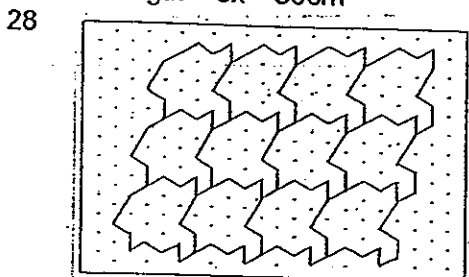

EXAM PAPER 2012

SCHOOL : NANYANG Primary School
SUBJECT : PRIMARY 6 MATHS

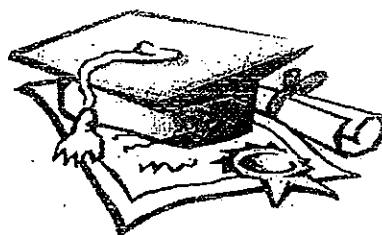

TERM : SA2

29 $(36.90 - (0.10 \times 69 + 45 \times 0.50)) \div 0.20 = 36$

30 Let the number of sisters be x
 $20y + 2 - 4y = 16y + 2$
 $(16y + 2) \div 4 = 4y + 0.5$

Mary has $4y + 0.5$ sisters.

Paper 2

1 $12 \div 3 = 4$
 $4 \times 10\$ = \40
 $12 \div 4 = 3$
 $3 \times \$5 = \15
 $\$40 + \$15 = \$55$

2 $1/2 \times 10 \times 10 = 50$
 $50 \times 3 = 150 \text{ cm}^2$

3 $\$20 \div 3 = 6.6667$
 $6 \times 5 = 30$
 $6 \times p = 6p$

4 $440 - 395 = 45$
 $45/395 \times 100\% = 11\%$

5 $19 \times 5 = 95$
 $19 \times 2 = 38$
 $95 - 38 = 57$

6 $20 \times 3 = 60$
 $60 - 36 = 24$
 $3 + 1 = 4$
 $24 \div 4 = 6$

7 $900 \text{ SGD} = 0.79 \times 900 = 711 \text{ USD}$
 $711 \text{ USD} \div 0.13 = 5469 \text{ HKD}$

8

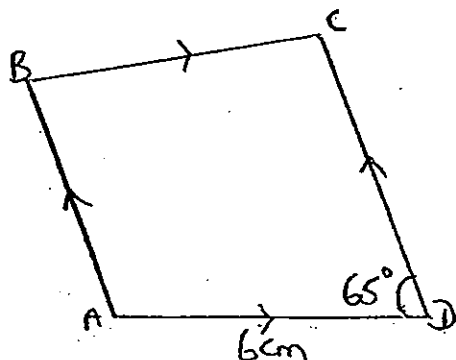

EXAM PAPER 2012

SCHOOL : NANYANG Primary School
SUBJECT : PRIMARY 6 MATHS

TERM : SA2

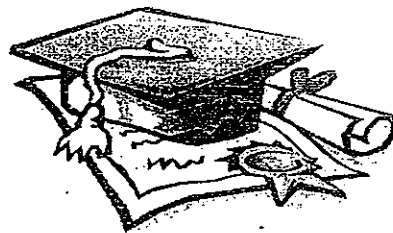

- 9a Studying
- 9b 1 day = 24 hours
 $24 \times 7 = 168$ hours
 $55 + 44 + 18 + 12 + 41 = 172$
 $172 - 168 = 4$
4 hour > 10%
44h > 110%
 $44 \div 11 \times 10 = 40$
- 10 Total speed = $160 + 200 = 360$ m/min
Total distance for meeting twice 1 and a half rounds,
meaning 1.5×400 m = 600m

Total time needed to run 600m = $600 \div 360 = 1 \frac{2}{3}$ minutes
Tom would have ran: $1 \frac{2}{3} \times 160 = 266 \frac{2}{3}$ m
- 11 Amount of water that tank can contain =
 $= (62 - 3) \times (25 - 3) \times (41 - 1.5)$
 $= 51271$

Number of seconds in half hour = $60 \times 30 = 1800$ sec
Volume of water flowed = $1800 \times 34 = 61200$

Overflowed = $61200 - 49324$
 $= 9929 \text{ cm}^3$
- 12 $180 \div 3 = 60$
 $90 - 60 = 30$
 $180 - 105 = 75$ (angle GBC and GCB)
 $75 + 18 + 17 = 110$ (angle EBC + angle ECB)
- (b) $180 - 110 = 70$ (angle BEC)
 $(180 - 30) \div 2 = 75$
- (a) Angle AFC = $75 + 60 = 135$
- 13a $85\% = 38.25$
 $100\% = 100/85 \times 38.25 = \45
- 13b ABC Original Price = 1510
ABC Discounted price = $85/100 \times 1510 = \$1283.50$
XYZ Discounted price = $1283.50 - 38.25 = \$1245.25$
Percentage discount that ABC must offer to equal the price:
 $(1510 - 1245.25) \div 1510 \times 100 = 17.53\%$
Minimum percentage discount it has to offer = 18%

EXAM PAPER 2012

SCHOOL : NANYANG Primary School
SUBJECT : PRIMARY 6 MATHS

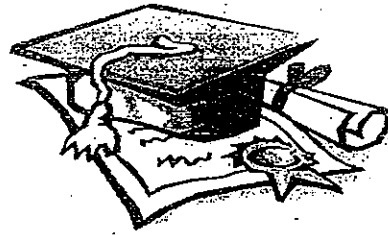

TERM : SA2

- 14 Figure A can be divided into 6 equal parts. If the middle section shifts to the side, it will form a $\frac{1}{3}$ of a circle.

ie: In figure A, shaded region adds up to 2 full circle

ie: In figure A, unshaded region also adds up to 2 full circle

One of the 6 areas of Figure A middle region:

$$2 \times [(\text{Area of small sector}) - (\text{area of equilateral triangle})] =$$

$$2 \times [(60/360 \times \pi \times 10^2) - (10^2 \times \sqrt{3} \div 4)] = 18.117$$

Full area of centre region of figure A = $6 \times 18.117 = 108.703$.

Figure A + B = one complete 7 overlapping rings + centre region

= 4 circles + centre region

$$= 4 \times \pi \times 10^2 + 108.703$$

$$= 1365.34\text{m}^2$$

15a 11,12,13,14

15bi 21,22,51,52

15bii 72

- 16 Last month

$$\text{Transport} = \frac{5}{20}$$

$$\text{Food} = \frac{9}{20}$$

$$\text{Saved} = \frac{6}{20}$$

$$\frac{20}{20} + \frac{1}{20} = \frac{110}{100}$$

This month

$$\text{Transport} = \frac{25}{100}$$

$$\text{Food} = \frac{46}{100}$$

$$\text{Saved} = \frac{6}{20} \div 100 \times 130 = \frac{39}{100}$$

$$\frac{39}{100} > \frac{780}{100}$$

16a $780 \div 39 = \$500$

16b $780 \div 39 \times 46 = \920

- 17 Let A be heaviest, B 2nd heaviest, C 3rd heaviest and D the lightest

$$A + B + C = 116.3 \quad > \text{Equation 1}$$

$$B + C + D = 99.5 \quad > \text{Equation 2}$$

$$A + B + D = 111.7 \quad > \text{Equation 3}$$

$$A + C + D = 108.1 \quad > \text{Equation 4}$$

$$E1 + E2 + E3 + E4: \quad 3A + 3B + 3C + 3D = 435.6$$

$$A + B + C + D = 145.2 \quad > \text{Equation 5}$$

EXAM PAPER 2012

SCHOOL : NANYANG Primary School
SUBJECT : PRIMARY 6 MATHS

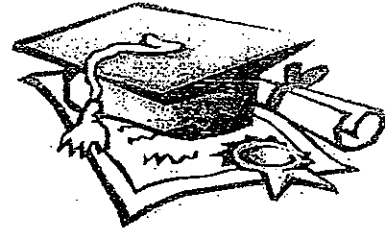

TERM : SA2

E5 - E1: D = 28.9

E5 - E3: C = 33.5

E5 - E4: B = 37.1

E5 - E2: A = 45.7

$$45.7 + 28.9 = 74.6\text{kg}$$

- 18 Trial and error:
School A: 36
School B: 18
School C: 42
Total representatives = 96

