



# RAFFLES GIRLS' PRIMARY SCHOOL

## SEMESTRAL ASSESSMENT (2) 2012

Name : \_\_\_\_\_ Index No: \_\_\_\_\_ Class: P4 \_\_\_\_\_

22 October 2012

SCIENCE

Att: 1 h 30 min

### SECTION A (25 x 2 marks)

For each question from 1 to 25, four options are given.  
One of them is the correct answer. Make your choice (1, 2, 3 or 4).  
Shade the correct oval (1, 2, 3 or 4) on the Optical Answer Sheet (OAS) provided.

Section A	50	
Section B	40	
Your score out of 90		
Highest score	Class	Level
Average score		
Parent's signature		

1. The table below shows how some living things can be grouped.

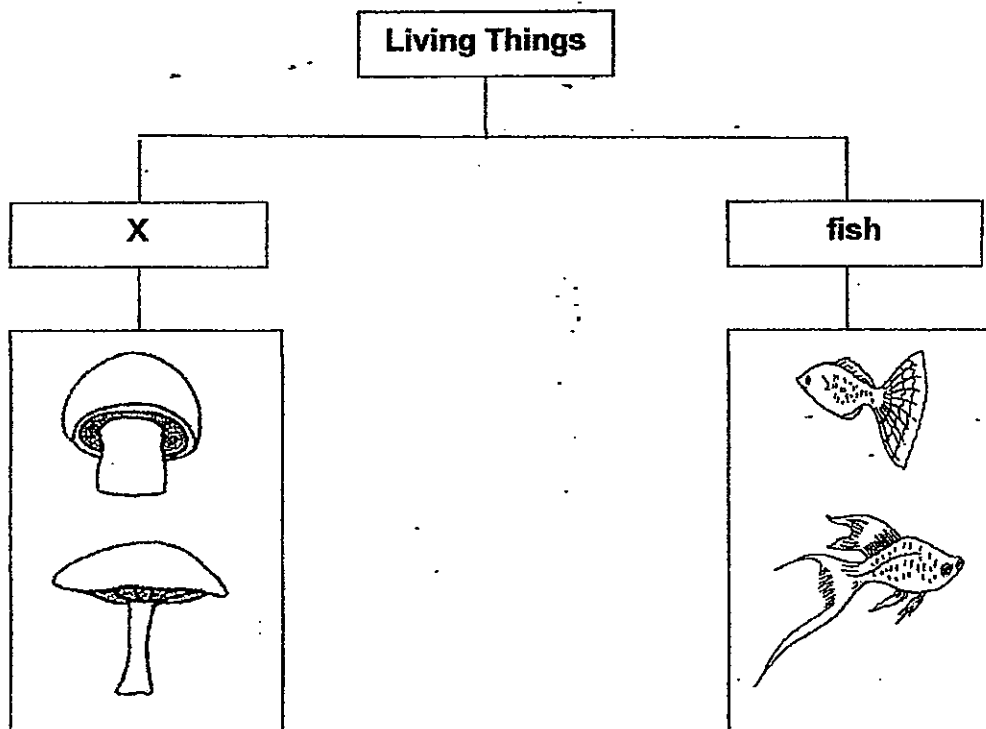

Which one of the following is the most suitable heading for group X?

- |              |             |
|--------------|-------------|
| (1) bacteria | (2) fungi   |
| (3) Insects  | (4) mammals |

2. Study the chart below.

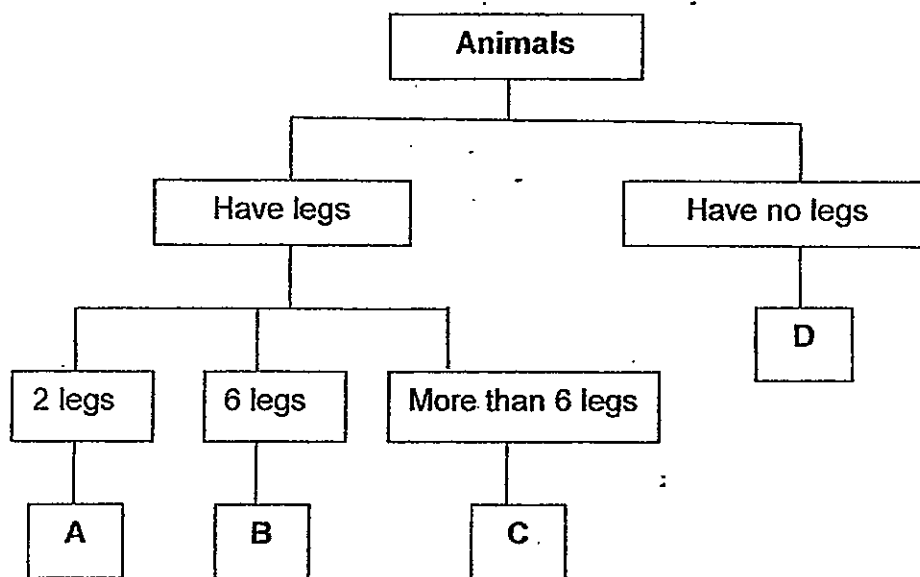

Where would you put this animal in the chart above?

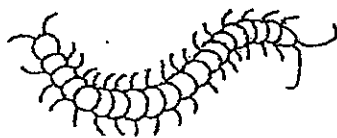

- (1) A
- (2) B
- (3) C
- (4) D

3. Lin Min indicated the characteristics of four different types of plants, A, B, C and D, by putting a tick in the table below.

Characteristics			
Types of Plants	Reproduces from seeds	Reproduces from spores	Bears fruit
Flowering Plant A	√		√
Flowering Plant B		√	√
Non-flowering Plant C		√	√
Non-flowering Plant D		√	

Her teacher remarked that there were errors in the identification above.

Which of the following shows the plants with the correct identification of their characteristics by Lin Min?

- (1) Flowering Plant A and Non-flowering Plant C
- (2) Flowering Plant A and Non-flowering Plant D
- (3) Flowering Plant B and Non-flowering Plant D
- (4) Flowering Plant B and Non-flowering Plant C

4. The diagram below shows the stages in the life cycles of two animals, Animal X and Animal Y.

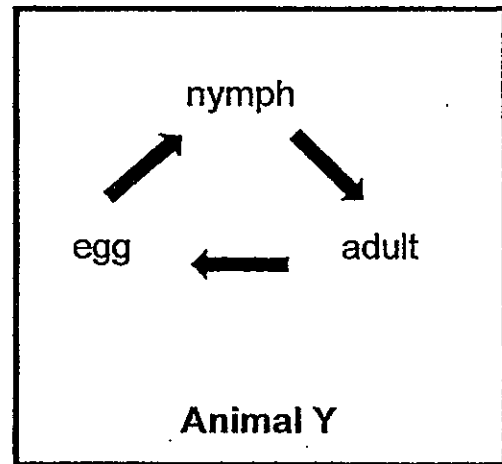
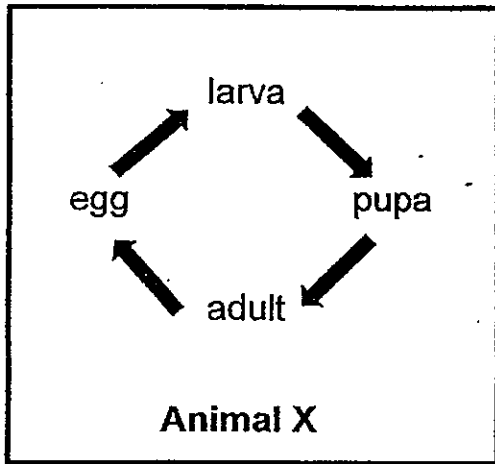

Which of the following animals have similar life cycles as Animal X and Animal Y?

	Animal X	Animal Y
(1)	cockroach	frog
(2)	frog	mosquito
(3)	butterfly	mosquito
(4)	butterfly	cockroach

5. The diagrams below show the life cycles of 4 different types of insects.

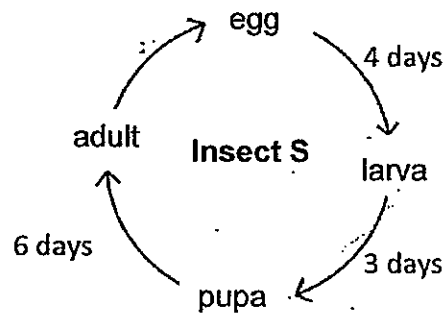
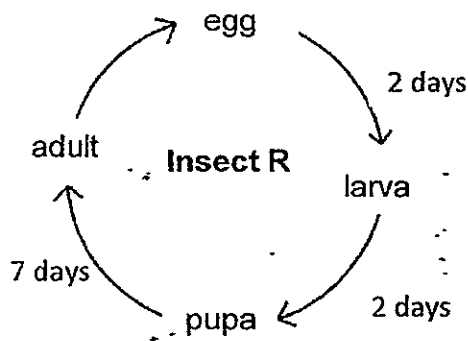
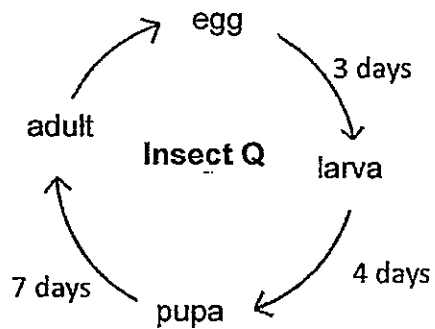
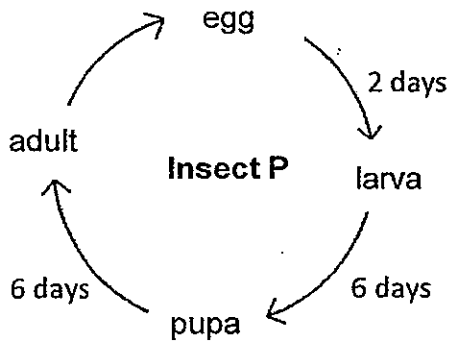

The larvae of insects P, Q, R and S feed on the leaves of lime plants and grow rapidly. The table below shows the amount of leaves which the larvae of insects P, Q, R and S feed on.

	Larvae of insect P	Larvae of insect Q	Larvae of insect R	Larvae of insect S
Amount of leaves eaten by the larvae per day	100g	200g	100g	200g

From the information given in the diagrams and table above, which one of these insects is likely to be the most destructive to lime plants?

- (1) Insect P
- (2) Insect Q
- (3) Insect R
- (4) Insect S

6. Tim set up an experiment below in a classroom to find out the conditions needed for seeds to germinate. Object X is able to remove air from the surrounding.

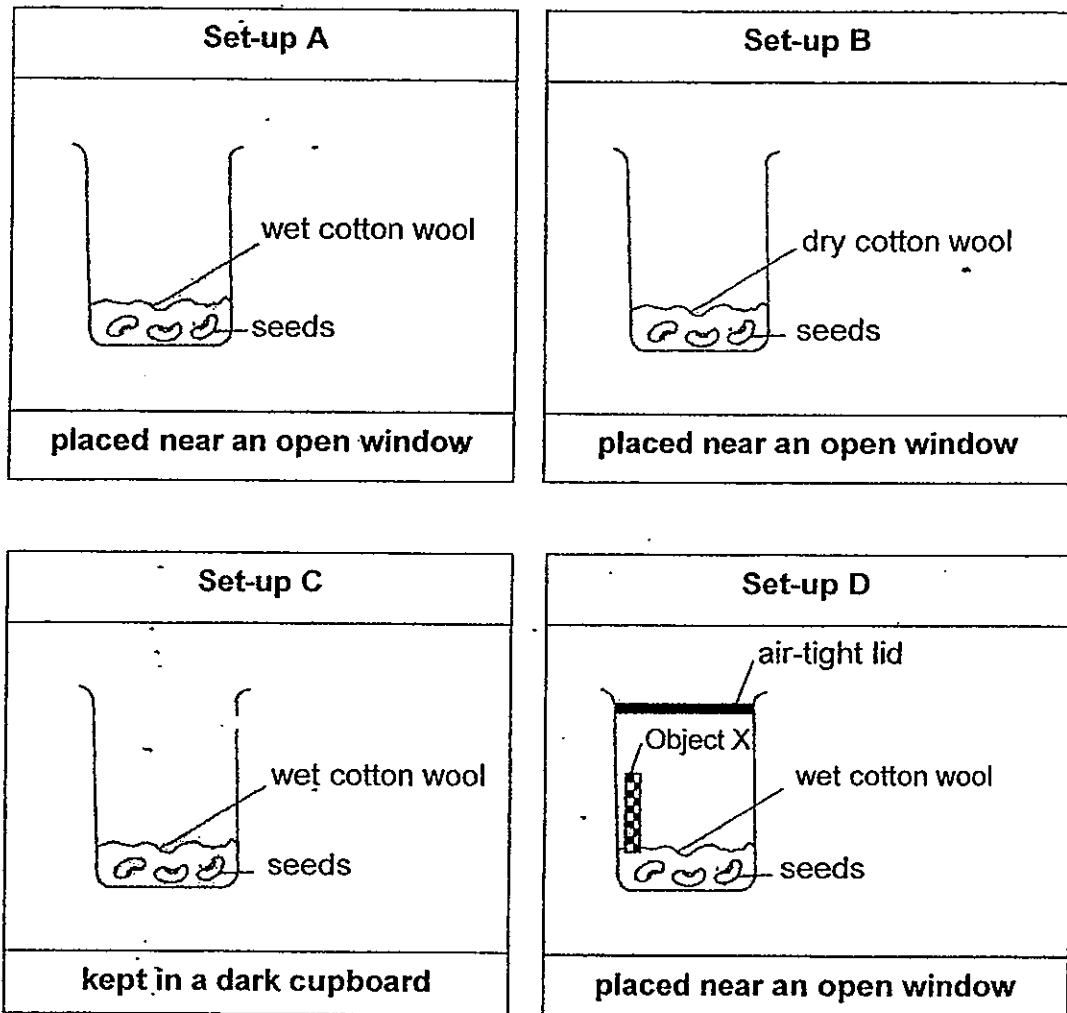

Tim put an equal number of similar seeds in each of the identical beaker, A, B, C and D, as shown above.

Which of the following set-up(s) would most likely to observe germination of seed?

- (1) A only
- (2) A and C only
- (3) B and D only
- (4) A, B, C and D

7. The diagram below shows the growth of a young plant with two missing stages ~~X~~ and ~~Y~~.

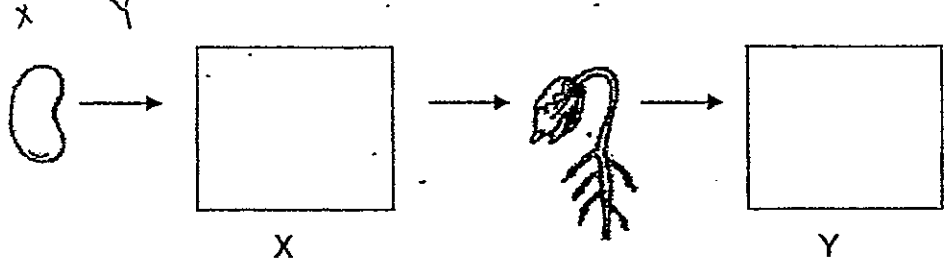

Which one of the following shows the correct stages for X and Y?

	X	Y
(1)		
(2)		
(3)		
(4)		

8. Study the diagram below carefully.

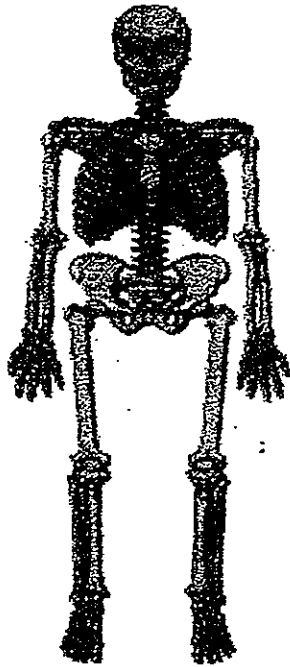

Which of the statements best describe the functions of the human system shown above?

- A It gives the body shape.
- B It protects the important organs.
- C It breaks down food into simpler forms.
- D It enables the exchange of gases with the surroundings.

- (1) A and B only
- (2) A and D only
- (3) B and C only
- (4) ~~X~~ and D only

↓  
C



9. The diagram below shows a young plant.



The leaf helps the plant to \_\_\_\_\_.

- (1) absorb nutrient
- (2) absorb water
- (3) grow upright
- (4) make food

10. The diagram below shows a plant. The part labeled X \_\_\_\_\_.

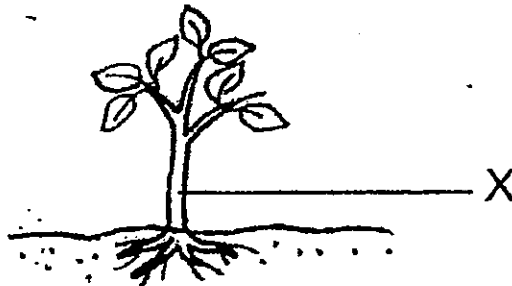

- A anchors the plant firmly to the ground
- B contains tubes to transport food to the leaves
- C helps the plant to absorb water and mineral salts
- D contains tubes to transport water to the leaves

- (1) B only
- (2) D only
- (3) A and C only
- (4) A, B and D only

11. Siti removed a part of the stem from the plant as shown in the diagram below.

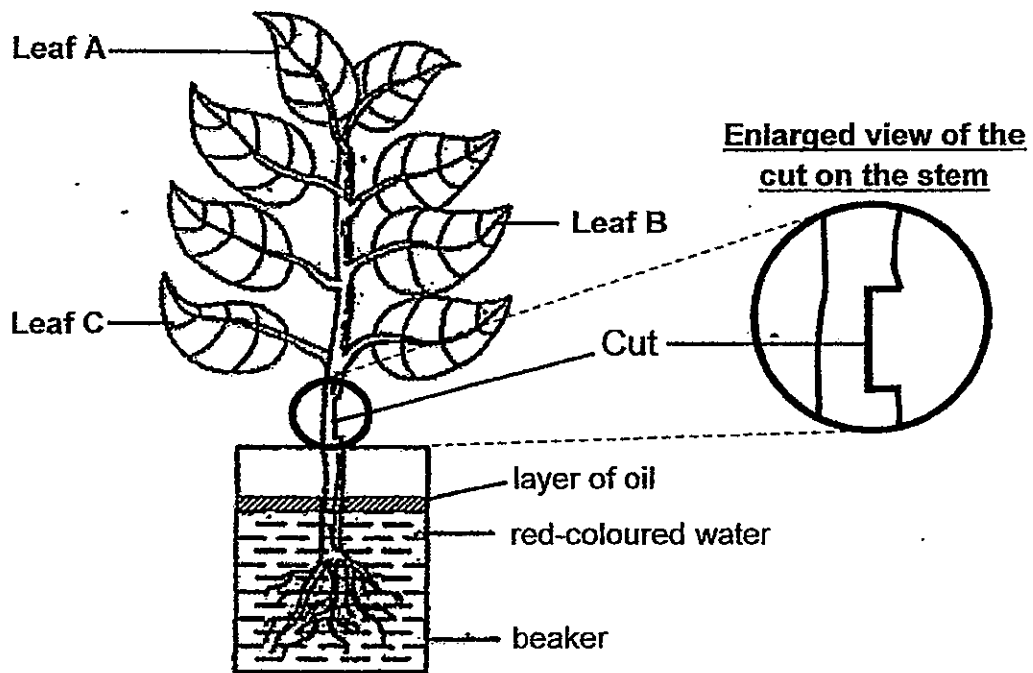

She then placed the plant in a beaker of red-coloured water and recorded her observations after 6 hours in the table below.

Leaf	Was it stained red?
A	Yes
B	No
C	Yes

Which of the following statements below best explains why leaf B was not stained red?

- (1) Part of the food-carrying tubes leading to leaf A and C were removed but not the one leading to leaf B.
- (2) Part of the food-carrying tubes leading to leaf B were removed but not the one leading to leaf A and C.
- (3) Part of the water-carrying tubes leading to leaf A and C were removed but not the one leading to leaf B.
- (4) Part of the water-carrying tubes leading to leaf B were removed but not the one leading to leaf A and C.

12. Peter conducted a test to find out the property of the materials which the cubes, P, Q and R, are made of.

Cubes P, Q and R are of similar shapes and sizes.

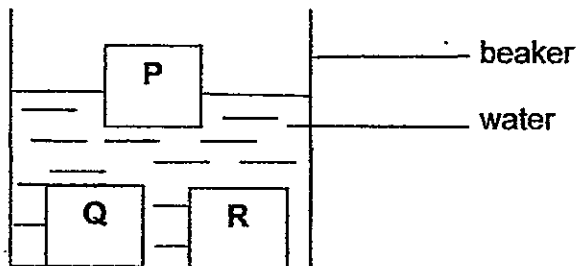

Based on his observation shown in the diagram above, Peter classified the cubes as shown in the classification table below.

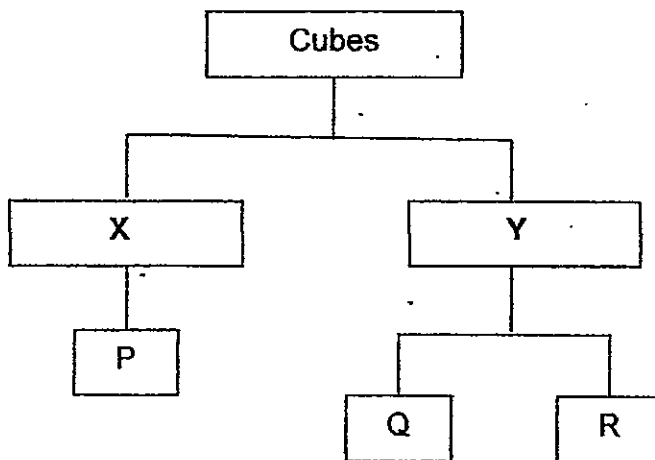

Based on the information above, which of the following best describes the property represented by X and Y respectively?

	X	Y
(1)	waterproof	not waterproof
(2)	weak	strong
(3)	floats on water	sinks in water
(4)	flexible	stiff

- 13 Minah conducted an investigation to find out how much water 4 different materials can absorb. She placed each sheet of material, W, X, Y and Z, of the identical size and thickness over a wire mesh and placed them over a measuring cylinder. She then poured an equal amount of water over each material.

The diagram below showed the result at the end of 4 minutes.

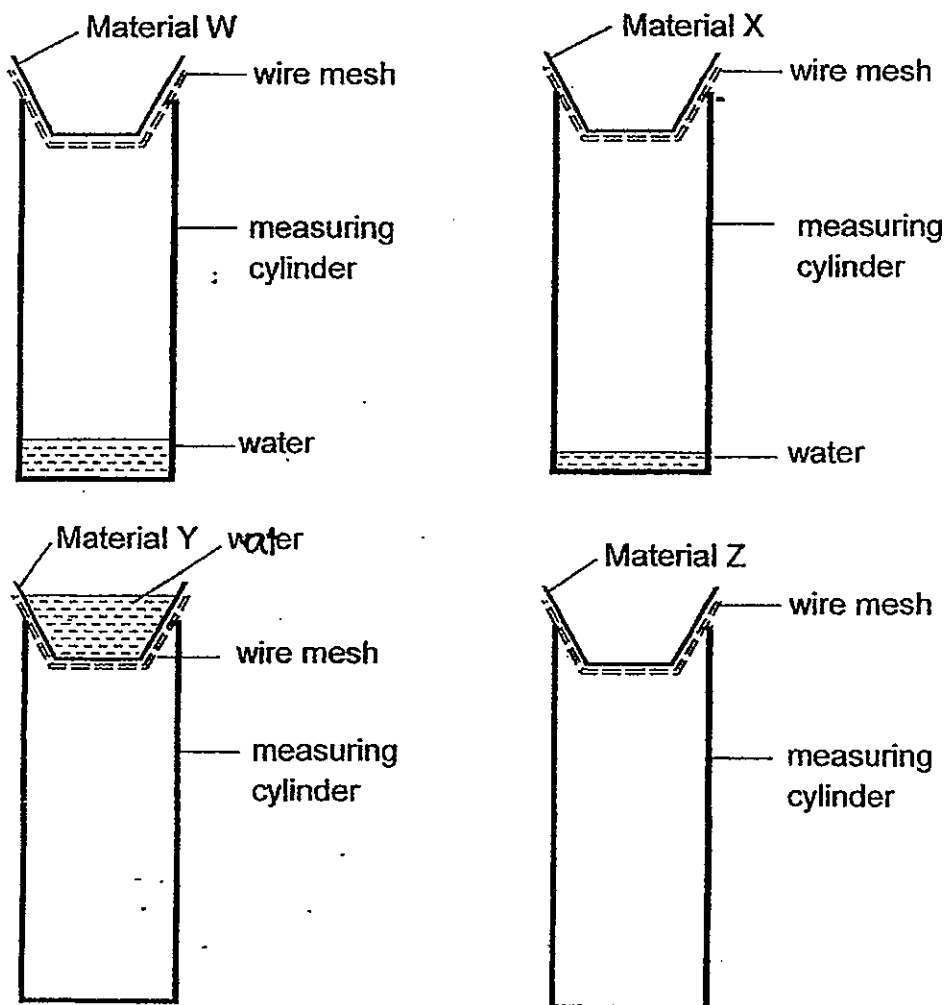

Based on the observation above, which of the following materials is best made into a mop to clean up spill most effectively?

- (1) Material W
- (2) Material X
- (3) Material Y
- (4) Material Z

14. Matter is anything that has mass and occupies space.

Which one of the following is **NOT** matter?

- (1) Air
- (2) Soil
- (3) Water
- (4) Electricity

15. Jane set up an experiment as shown below.

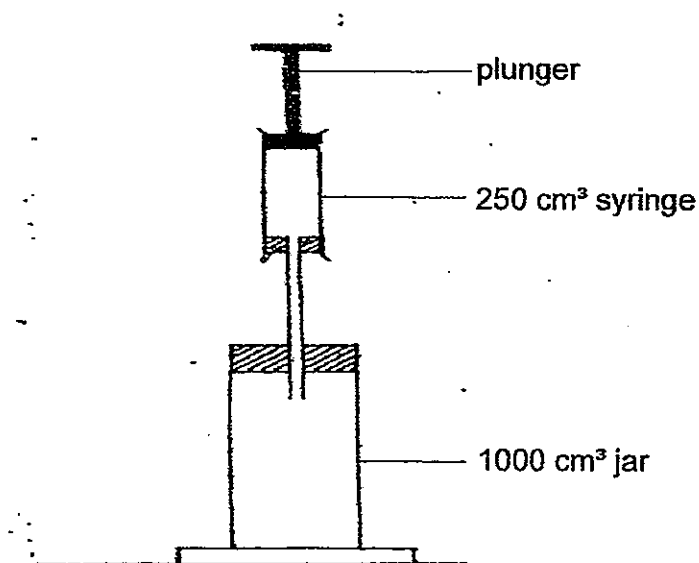

She used a syringe with a capacity of 250 cm<sup>3</sup> and pumped in a syringe full of air into the jar twice. What would be the total volume of air in the jar now?

- (1) 250 cm<sup>3</sup>
- (2) 500 cm<sup>3</sup>
- (3) 1000 cm<sup>3</sup>
- (4) 1500 cm<sup>3</sup>

16. Study the diagram below carefully.

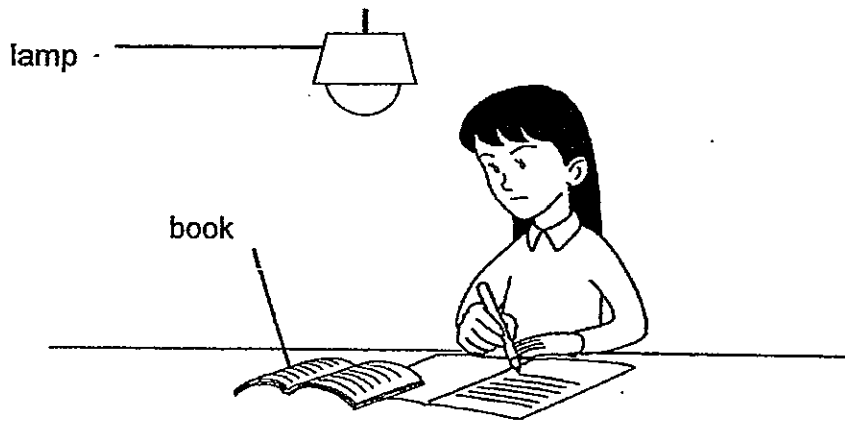

Which one of the following explains why Sue can see the book on the table when the lamp is switched on?

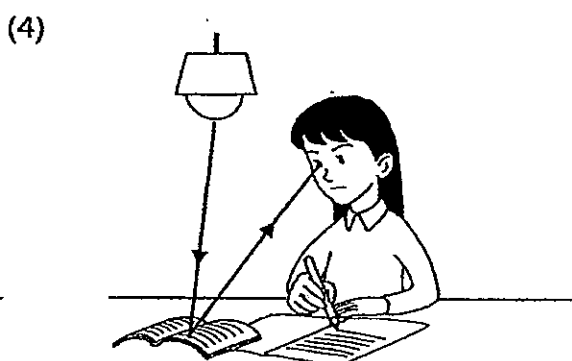
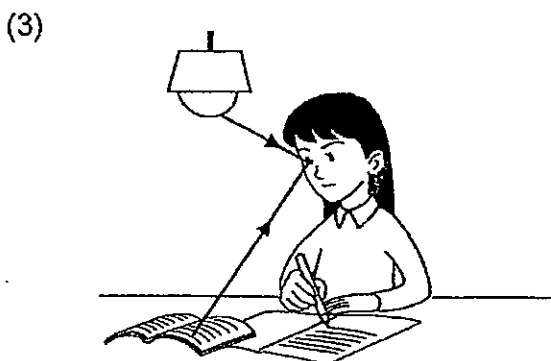
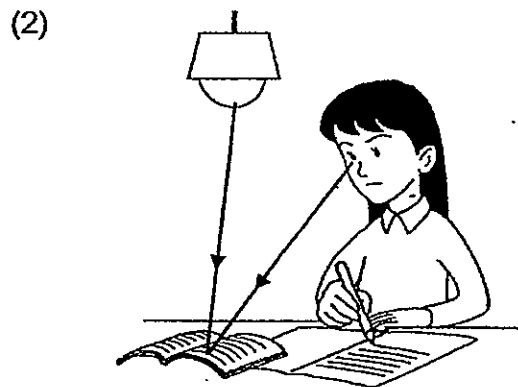
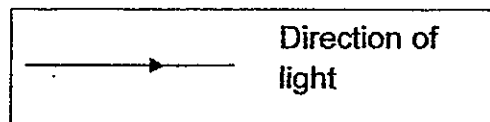

17. The experiment shown below was carried out in a dark room. Objects P, Q and R are each made of different materials. Object Q has a hole on it.

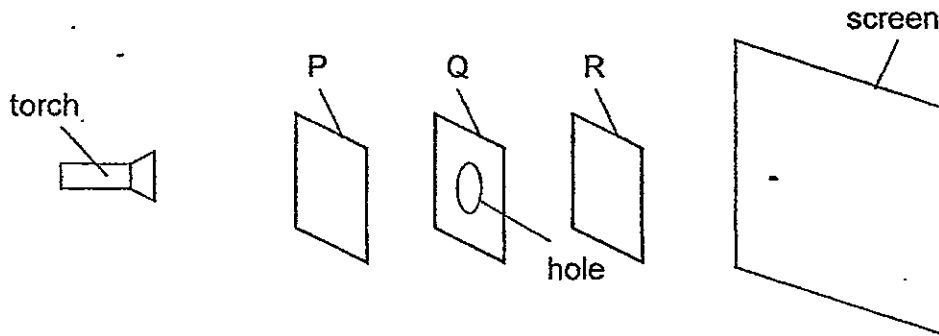

When the torch was switched on, a shadow was formed on the screen as shown below.

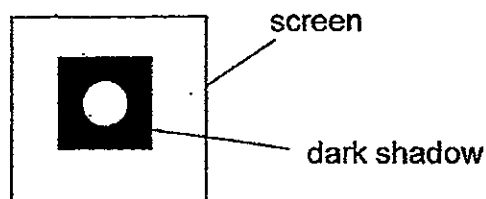

What material is each object, P, Q and R, most likely to be made of?

	Object P	Object Q	Object R
(1)	Cardboard	Tracing paper	Frosted glass
(2)	Clear plastic	Frosted glass	Tracing paper
(3)	Clear glass	Wood	Clear plastic
(4)	Wood	Cardboard	Clear glass

18. Mrs Lim was walking home from work one night along a street. She noticed that the length of her shadow changed as she walked towards and then away from the street lamp.

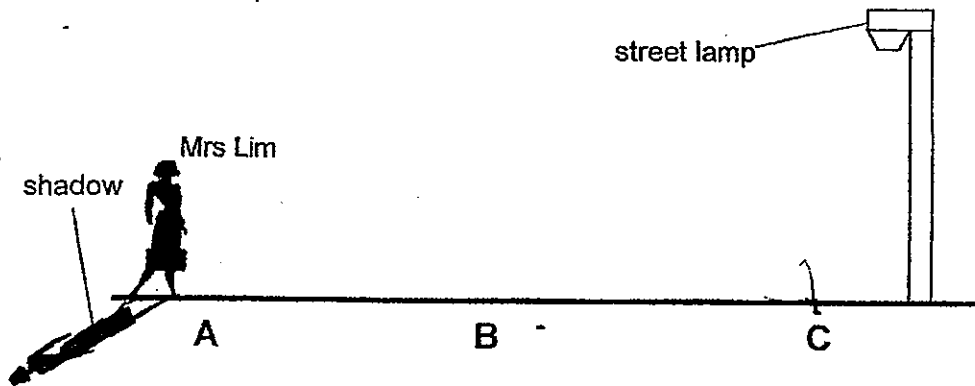

Which one of the following graphs shows the correct length of shadow as Mrs Lim walked from Point A to Point C?

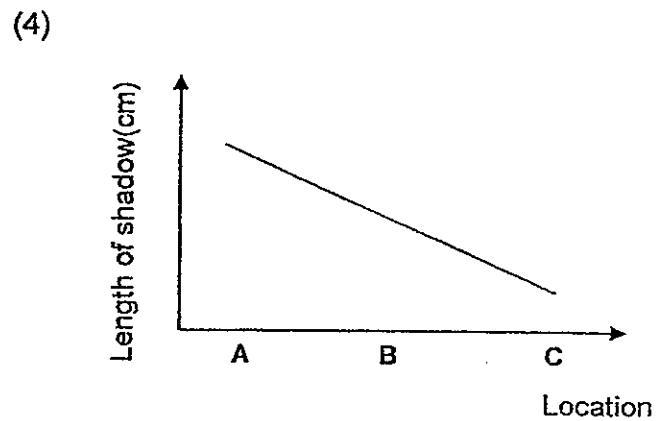
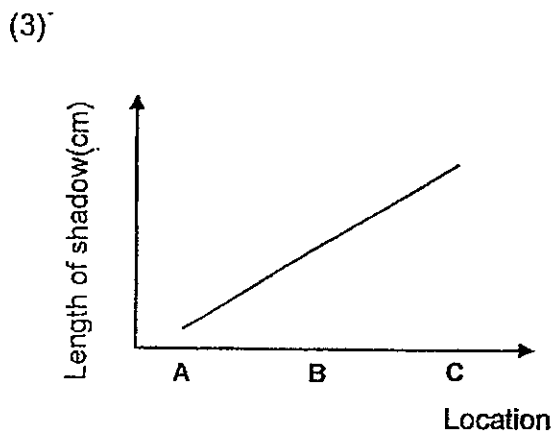
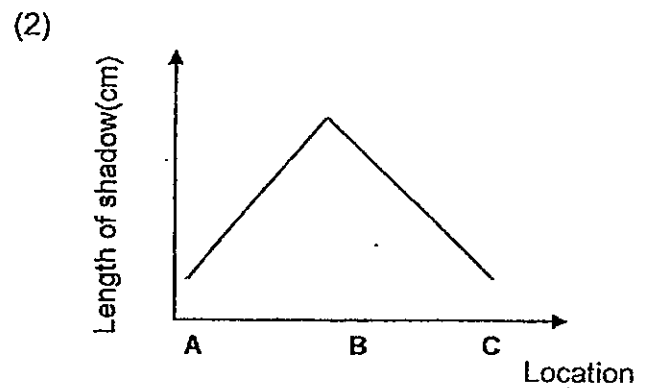
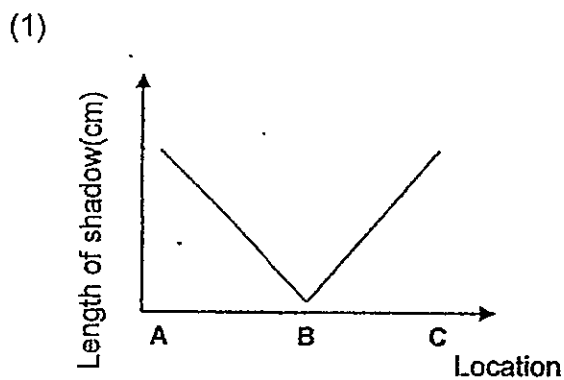



19. Catherine wants to measure the temperature of the hot water in the beaker. Which one of the following diagrams shows the correct position of the thermometer when taking the temperature reading?

(1)

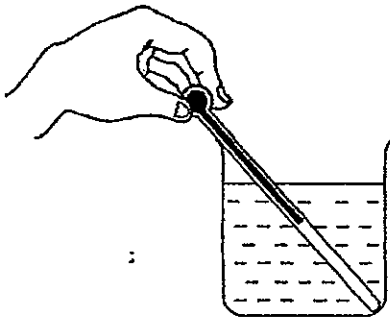

(2)

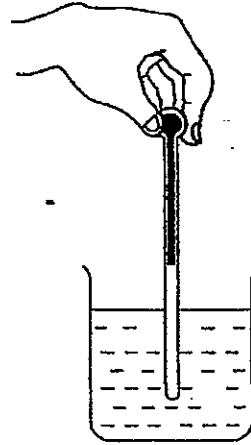

(3)

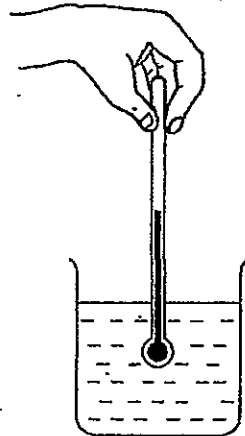

(4)

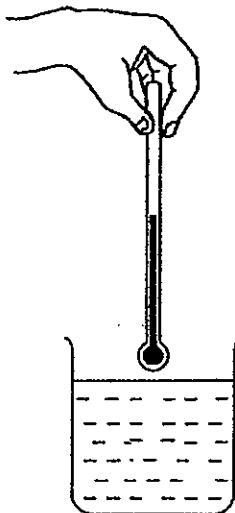

20. Amanda carried out an experiment as shown below. A test tube containing some water at  $20^{\circ}\text{C}$  was placed in the centre of a beaker with some ice. The beaker was then left in the science laboratory with a constant room temperature of  $30^{\circ}\text{C}$  for 15 minutes.

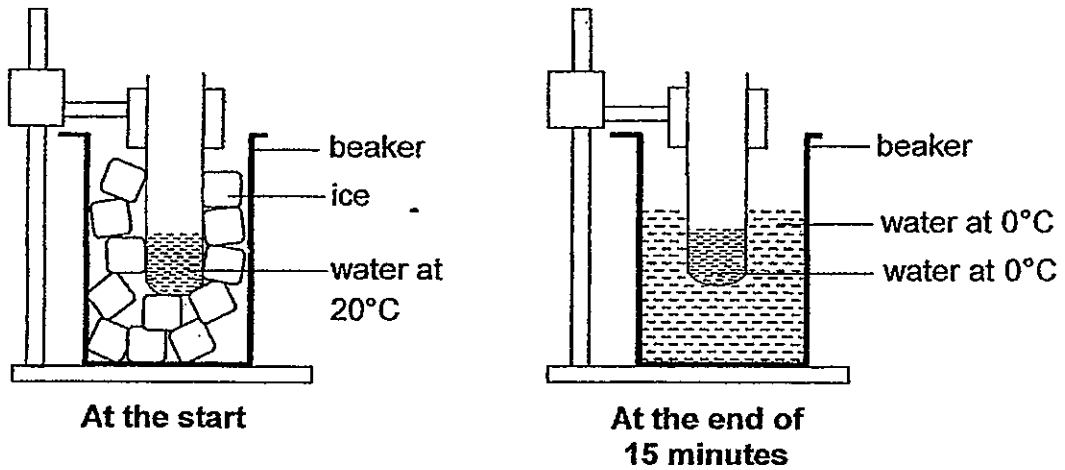

Which of the following statements is/are most likely to be correct based on the experiment above?

- A The test tube lost heat to the ice and became cooler.
- B The beaker lost heat to the surrounding and become cooler.
- C The ice gained heat from the water in the test tube and melted.
- D The water in the test tube lost heat to the ice and became cooler.

- (1) A only
- (2) B and D only
- (3) C and D only
- (4) A, C and D only

21. Muthu wanted to find out which material was the better conductor of heat between a pair of rods. Four rods, A, B, C and D, made of different materials were attached to an electrical heater. The table below shows the different materials he used.

Rod	A	B	C	D
Length of rod (cm)	40	50	50	50
Thickness of rod (cm)	3	3	3	3

The diagram below shows the set up.

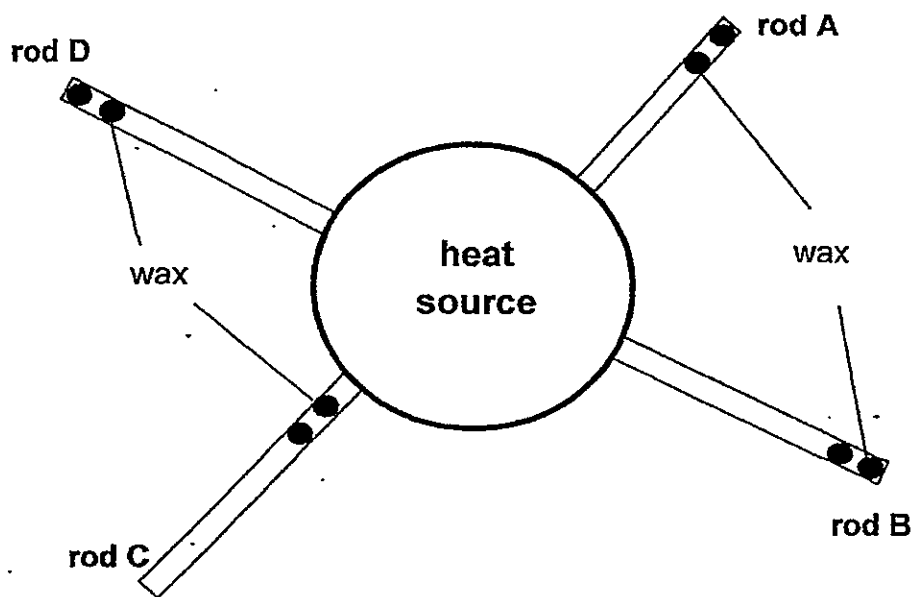

He placed two drops of wax of identical size on each rod.

Which two rods should he use to conduct a fair test?

- (1) A and B                      (2) B and D  
(3) A and C                      (4) C and D

22. - In which one of the following will the two magnets push each other away?

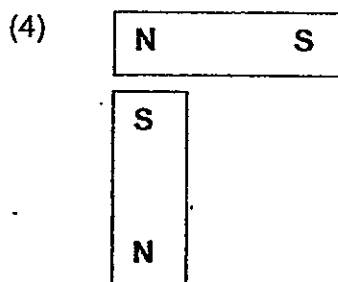
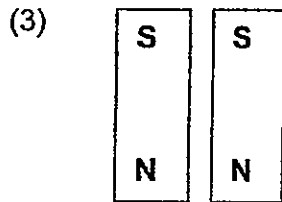
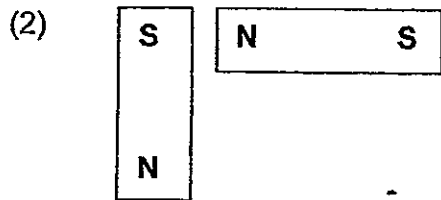
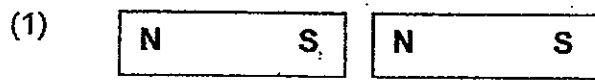

23. An object A was attracted to a magnet as shown in the figure below.

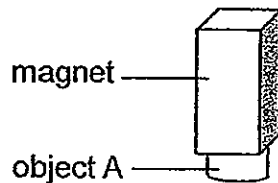

Object A is made of \_\_\_\_\_.

- |             |            |
|-------------|------------|
| (1) plastic | (2) rubber |
| (3) Steel   | (4) wood   |

24. Jane hanged two objects, X and Y, on each end of a balance. The balance moved downwards one end as shown in Diagram 1.

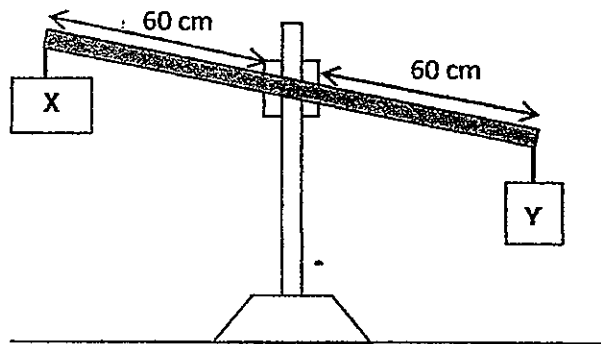

Diagram 1

Next, Jane placed object A directly below object Y and observed the result as shown in the diagram below.

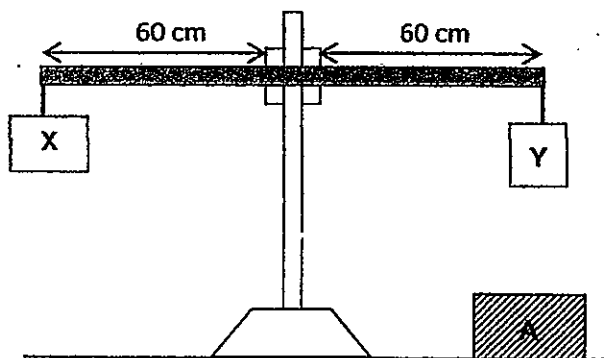
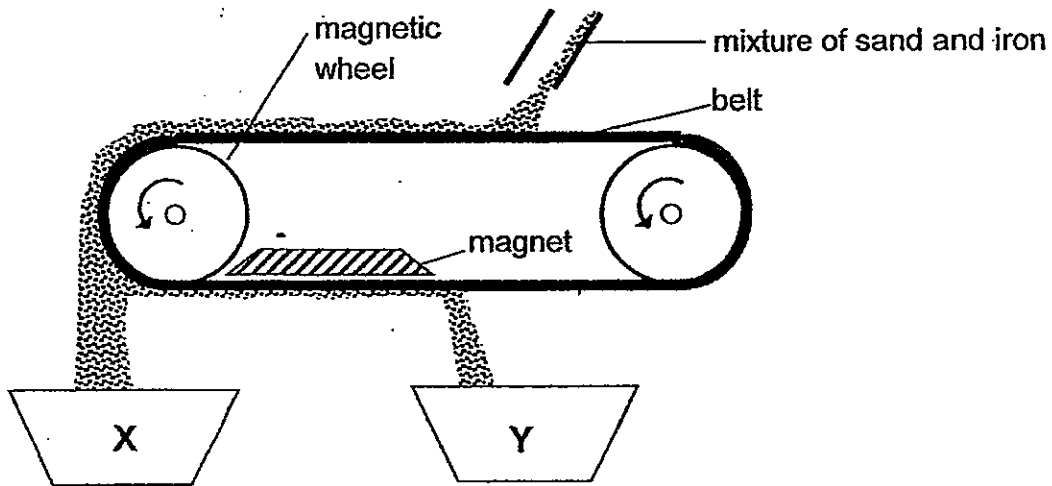

Diagram 2

Which one of the following best explains Jane's observation in Diagram 2?

- (1) Object Y was lighter than object X.
- (2) Objects A, X and Y were magnets.
- (3) Objects X and Y were of the same mass.
- (4) Objects A and Y were magnets with like poles facing each other.

25. The diagram below shows a way to separate magnetic metals and non-magnetic metals. A mixture of sand and iron is poured onto a moving belt.



The sand is collected in container X and the iron is collected in container Y as shown above.

Mr Chan wanted to fill container Y with more iron. He increased the amount of mixture of sand and iron poured on the belt. However, he discovered that the amount of iron collected in container Y remained the same.

What can Mr Chan do to fill container Y with more iron?

- A Increase the size of the magnet.
- B Increase the size of container X and Y.
- C Increase the magnetic strength of the magnet
- D Increase the magnetic strength of the magnetic wheel

- (1) A and C only
- (2) C and D only
- (3) B and D only
- (4) A, B, C and D

Name: \_\_\_\_\_ Index No: \_\_\_\_\_ Class : P4 \_\_\_\_\_

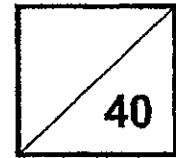

**SECTION B ( 40 marks)**

For questions 26 to 39, write your answers clearly in the spaces provided.  
The number of marks available is shown in the brackets [ ] at the end of the question or part question.

26. Jasmine observed and grouped some things as shown in the table.

F	G
tiger	stone
ant	cloth
mushroom	pen

What are suitable headings for F and G?

Group F: \_\_\_\_\_

[2]

Group G: \_\_\_\_\_

Score	2
-------	---

27. The pictures below show the different stages of the life cycle of a mosquito.

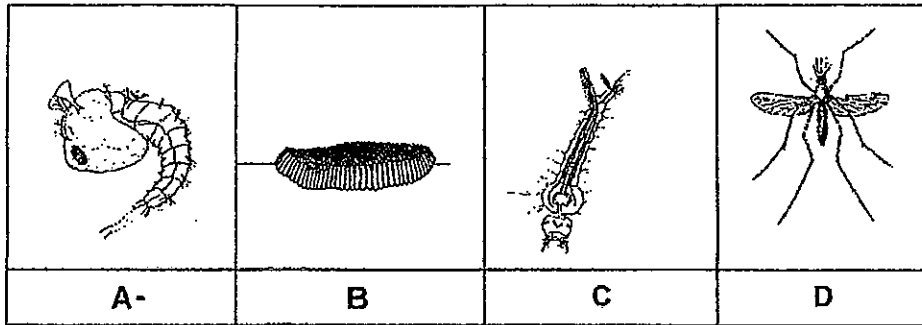

(a) Complete the life cycle of the mosquito by filling in the letters B, C and D in the boxes below. [1]

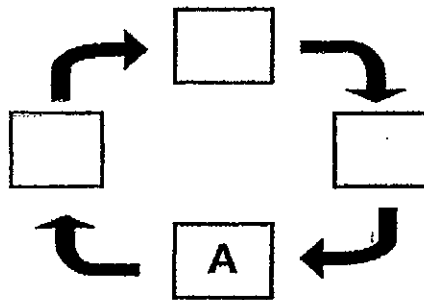

(b) Study the life cycle of Animal A below.

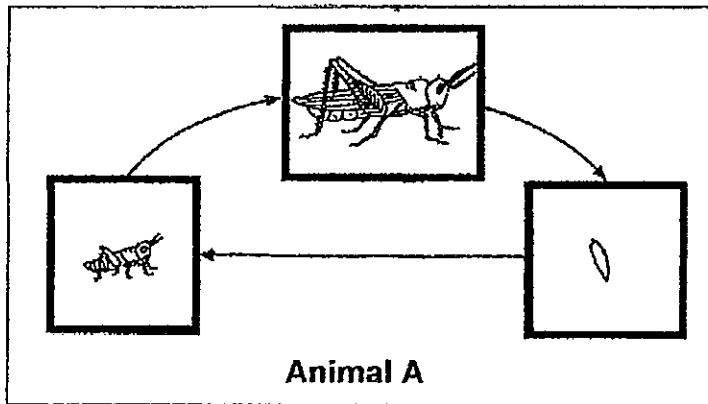

State **one difference** between the life cycles of Animal A and mosquito. [1]

---



---

Score	2
-------	---



28. The diagram below shows the human digestive system.

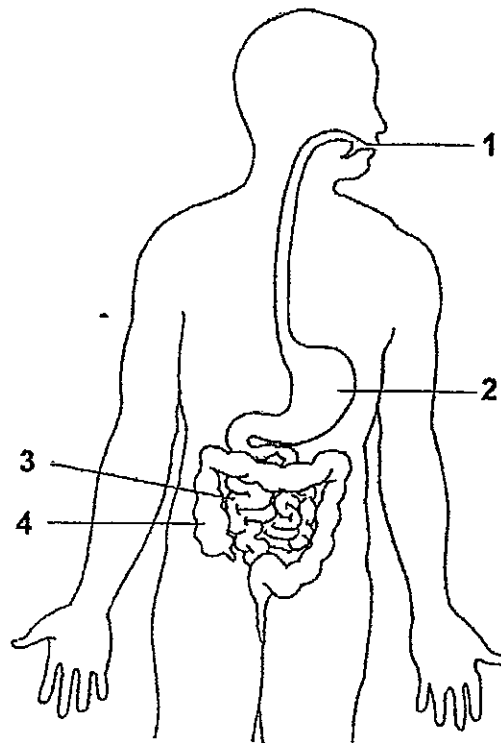

Identify the part where

(a) digestion first takes place : \_\_\_\_\_ [1]

(b) there is no digestion : \_\_\_\_\_ [1]

25	Score	2
----	-------	---

29. Ben ate three types of food, A, B and C, of equal amount. W, X, Y and Z are parts of the digestive system. The graph below shows the amount of digested and undigested food in the different parts of the digestive system.

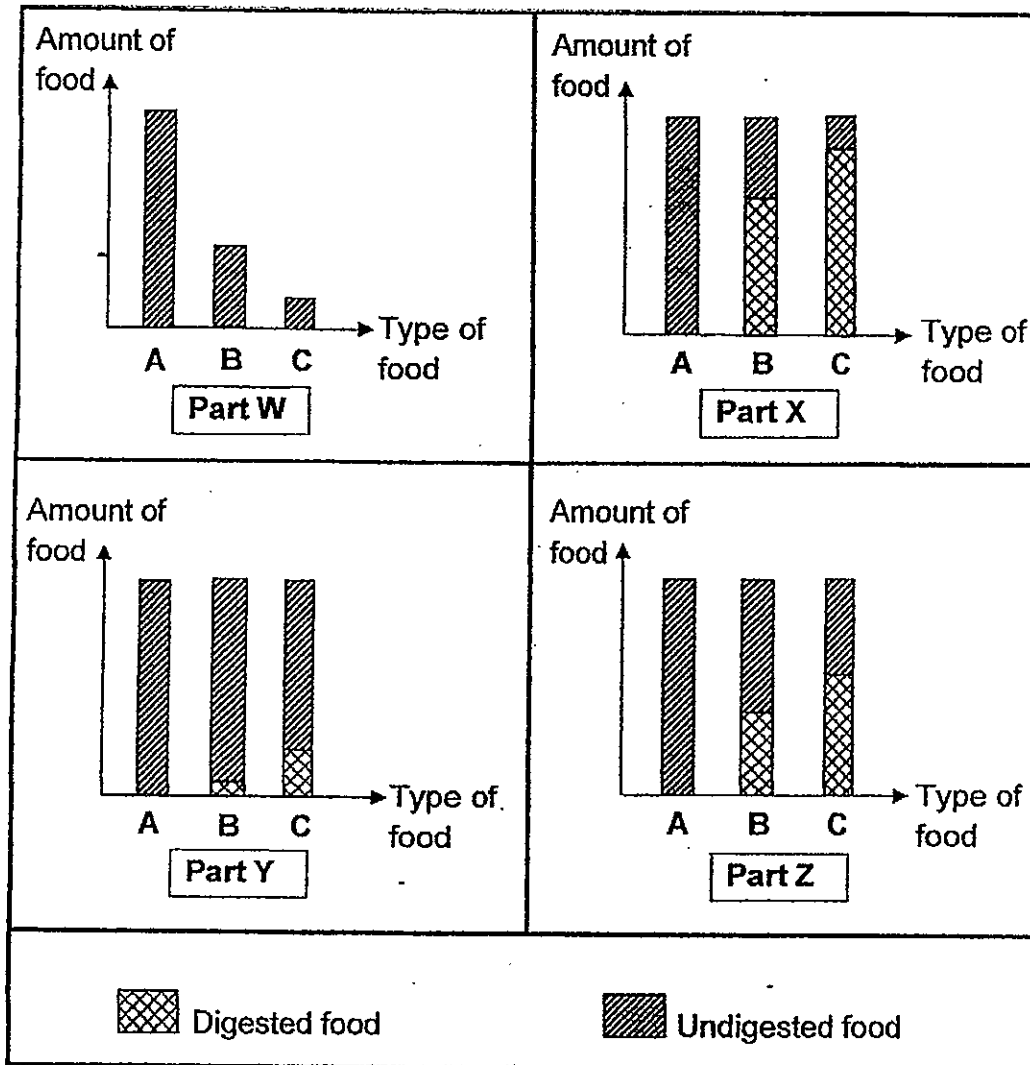

- (a) Which part of the digestive system, W, X, Y or Z, is most likely the mouth? [1]  
Part \_\_\_\_\_

Continue on page 27

Score	1
-------	---

- (b) Sometimes, some food such as seeds of certain fruit are consumed but not digested at all. Which type of food, A, B or C most likely represents such food? [1]

---

---

- (c) Which part of the digestive system, W, X, Y or Z, is most likely the large intestine? Give a reason for your answer. [1]

---

---

---

Score	2
-------	---

30. (a) The diagram below shows a plant.

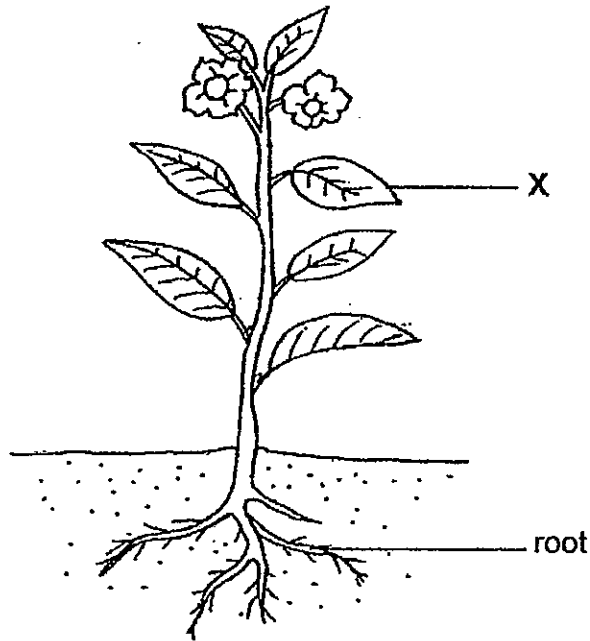

(i) Name plant part X.

[1]

X : \_\_\_\_\_

(ii) One substance that the roots of plant take in from the soil is

[1]

\_\_\_\_\_

Score	2
-------	---

- (b) Meiling placed two similar plants in identical jars. Each jar contained water at the same level as shown in the diagrams below. She then placed the two set-ups, X and Y, next to the window for 3 hours.

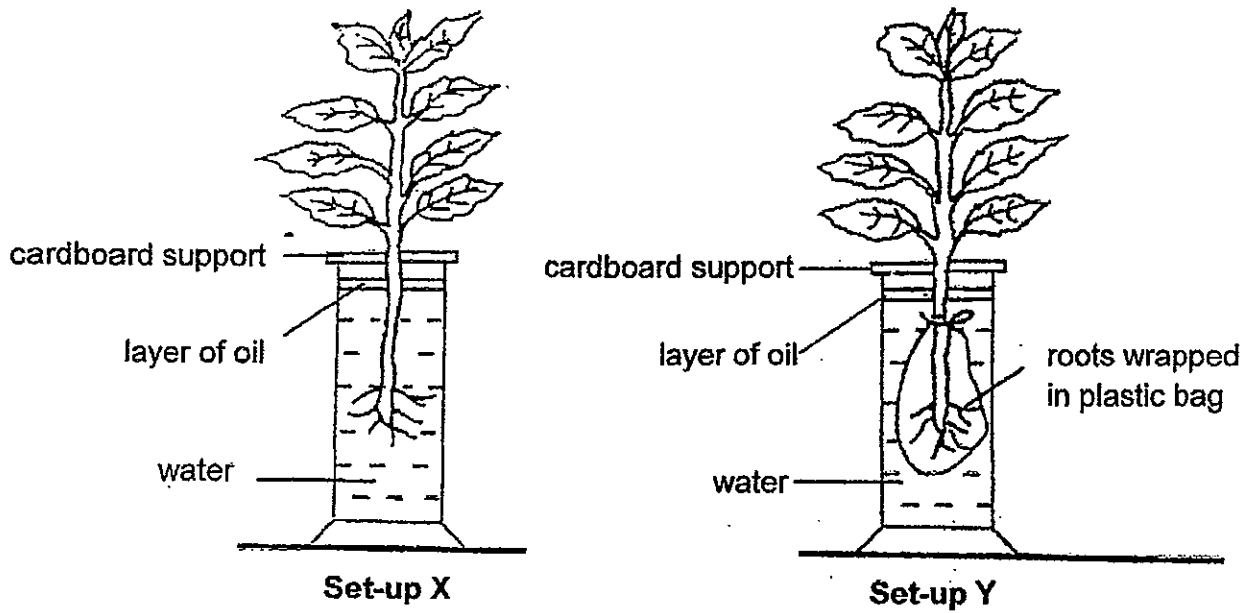

- (i) Based on the information above, what was Meiling trying to find out? [1]

---



---

- (ii) What would Meiling observe about the water level in the set-up Y after 3 hours? [1]

---



---

- 31 (a) Fatimah set up an experiment shown below. She hung four different strips of materials, R, S, T and U, each with a different thickness on a retort stand. The ends of the four strips of materials were dipped in four similar containers which contained some water.

She wanted to examine which material will absorb the most amount of water at a given time.

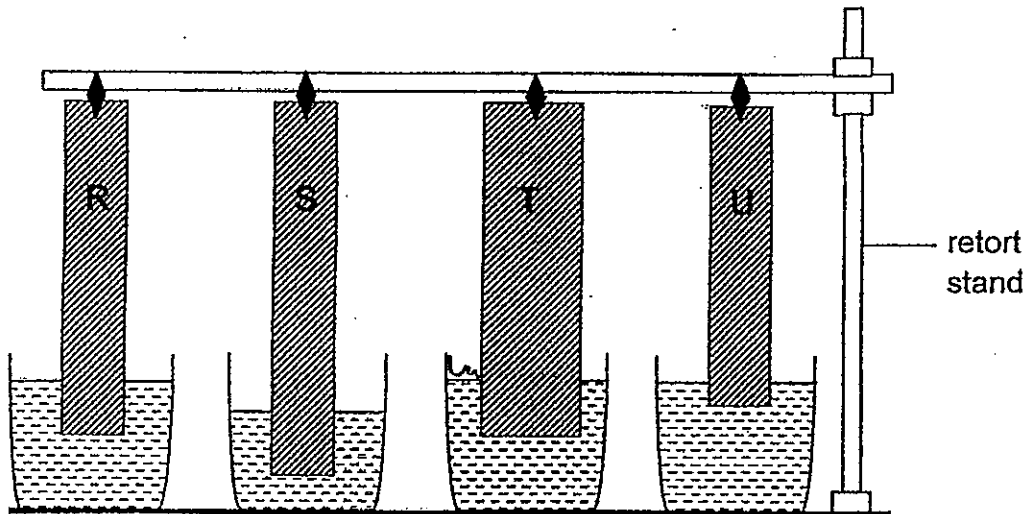

However, Fatimah's classmate said that she had not conducted a fair test.

Besides the length and width of the materials, write down **another** [2] **two** improvements Fatimah should make in order for her experiment to be a fair test.

(i) \_\_\_\_\_  
\_\_\_\_\_

(ii) \_\_\_\_\_  
\_\_\_\_\_

Score	2
-------	---

- (b) Study the flow chart below. A, B, C and D are objects with different physical properties.

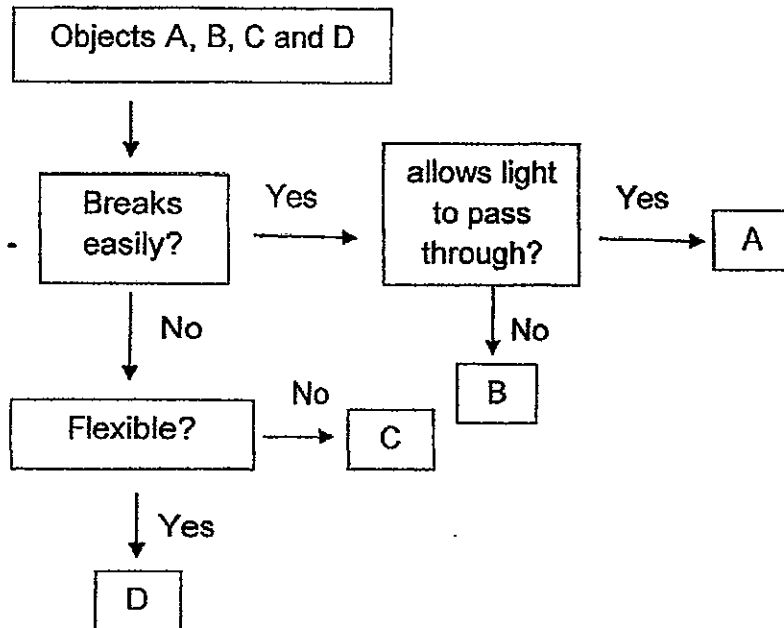

- (i) Based on the flow chart above, state two properties of object D. [1]

---

---

- (ii) What material can object A be made of? [1]

---

---

32. The diagram below shows a bottle of cooking oil.

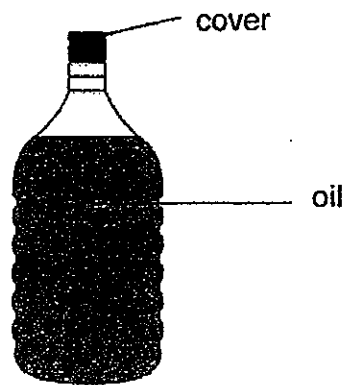

Complete the sentences to state if the parts are solid, liquid or gas.

(a) The cover is a \_\_\_\_\_ [1]

(b) Oil is a \_\_\_\_\_ [1]

Score	2
-------	---



33. Rachel had two identical glass containers, R and S, of the same mass and a volume of  $3500\text{ cm}^3$  each. She filled each container with  $3500\text{ cm}^3$  of air and placed them on a lever balance as shown in the diagram below

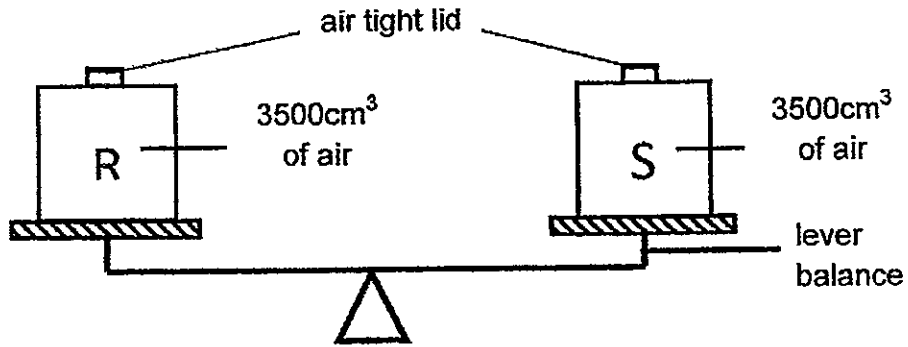

Rachel pumped in another  $1000\text{ cm}^3$  of air into glass container S. She then placed containers R and S onto the lever balance again.

- (a) (i) Draw what she would observe of the balance after  $1000\text{ cm}^3$  of air was pumped into glass container S in the box below. Label your diagram clearly.

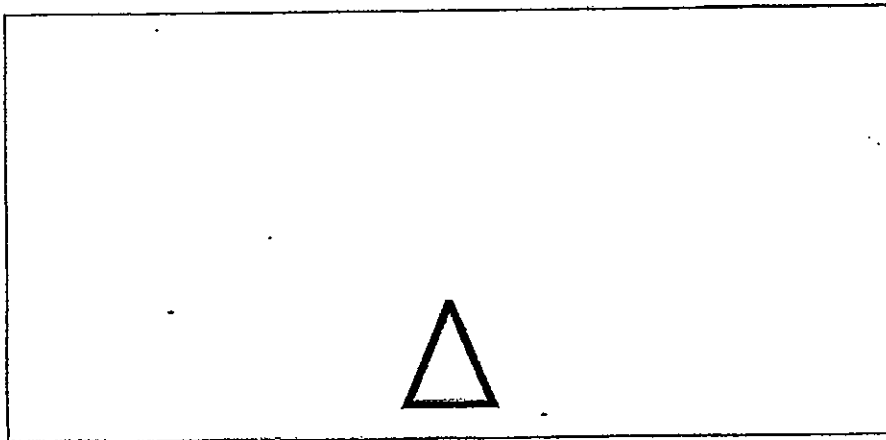

- (ii) Explain your answer in (i). [2]

---



---



---

- (b) What would be the volume of air in container R after  $1000\text{ cm}^3$  of air was removed from it? [1]

---

34

Water plants growing at the bottom of a pond take in any amount of sunlight which is able to pass through the water in order to make food. The diagram below shows how it happens.

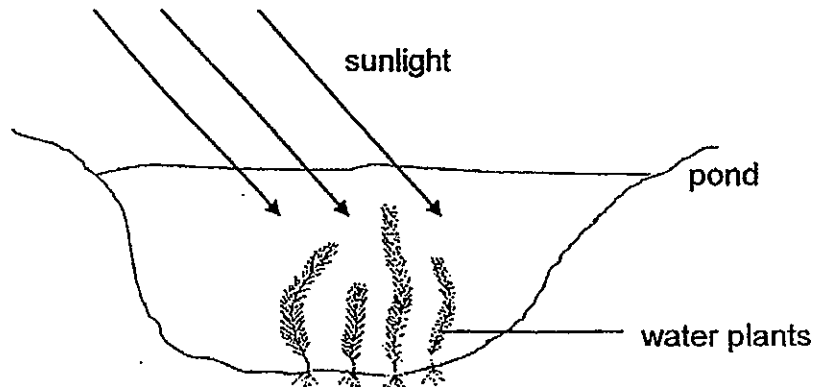

Ali collected 4 water samples A, B, C and D from 4 different ponds. He placed 50 ml of water sample A into a small beaker and set up the experiment as shown below.

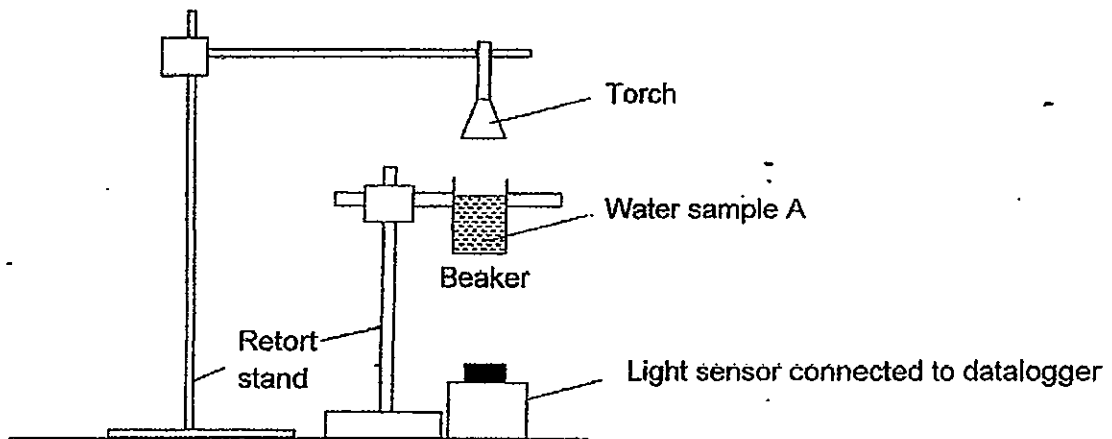

Ali then switched on his torch and shone it over water sample A in the beaker. He used a datalogger to measure how much light is able to pass through water sample A in the beaker. He repeated the same experiment for the other 3 water samples, B, C and D, one at a time. He recorded his observations in the table below.

Number of readings	Reading on the light sensor for each water sample (Lux)			
	A	B	C	D
1 <sup>st</sup>	500	800	61	1105
2 <sup>nd</sup>	505	805	63	1101
3 <sup>rd</sup>	495	807	59	1106
Average reading	500	804	61	1104

- (a) Plant X grows at the bottom of the pond, and it only grows well when it receives plenty of light. In which water sample, A, B, C or D, would Ali be able to find most number of plant X growing? Give a reason for your answer. [1]

---

---

---

---

- (b) Why did Ali take 3 readings of the amount of light that passed through the water for each of the water samples? [1]

---

---

35	Score	2
----	-------	---

35. The diagram below shows a frying pan.

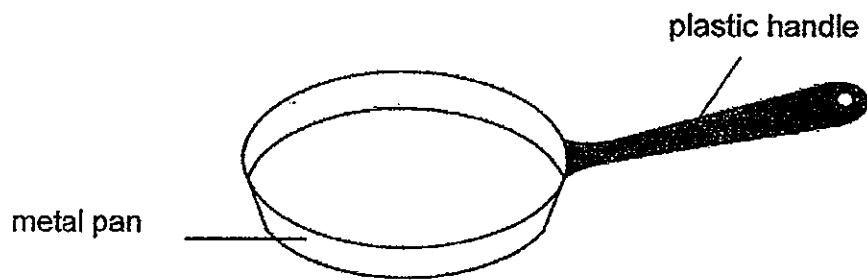

(a) The handle is made of plastic because it is a \_\_\_\_\_ conductor of heat. [1]

(b) The pan is made of metal because it is a \_\_\_\_\_ conductor of heat. [1]

Score	2
-------	---

36.

David took a metal ball from the freezer and put it into a beaker of water with a temperature of  $50\text{ }^{\circ}\text{C}$  as shown in the diagram below. The set-up was placed in a room with constant temperature of  $29\text{ }^{\circ}\text{C}$ .

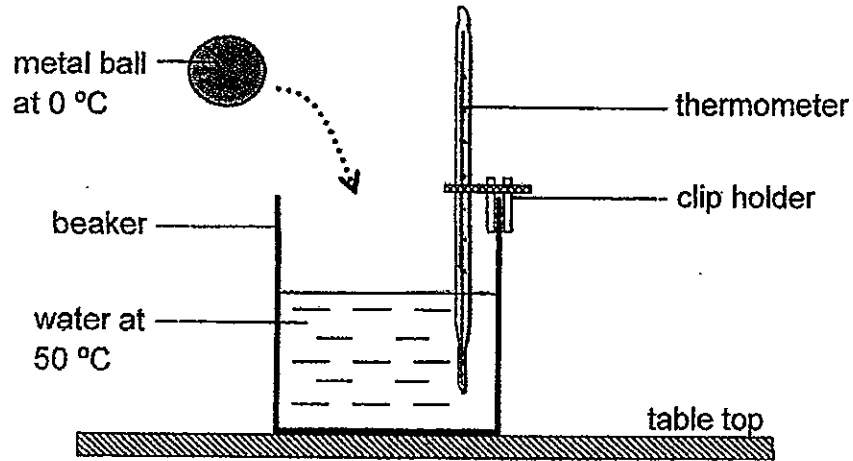

- (a) What would happen to the water level in the beaker when the metal ball was put in it? [1]

---

- (b) What would happen to the temperature of the water in the beaker after the metal ball was placed in it? Explain your answer. [2]

---

---

---

- (c) After 12 hours, what is most likely to be the temperature of the water in the beaker? [1]

---

37. Susan places a magnet near an iron rod. The iron rod moves towards the magnet.



(a) The magnet exerts a \_\_\_\_\_ on the iron rod. [1]

(b) Choose the correct word from the box to answer the question below.

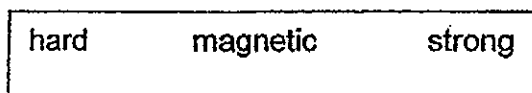

Susan's observation shows that iron is a \_\_\_\_\_ material. [1]

Score	2
-------	---

38. A steel bar was magnetised using the "stroke" method as shown in Diagram 1 below.

Diagram 2 shows the magnetic poles of the steel bar after it was magnetised.

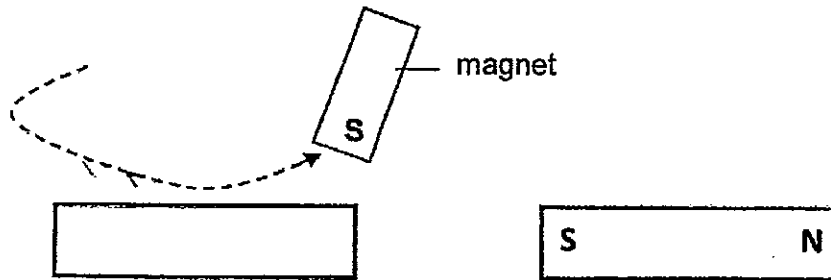

Diagram 1

Diagram 2

Two magnets were used to stroke another steel bar as shown in Diagram 3 below.

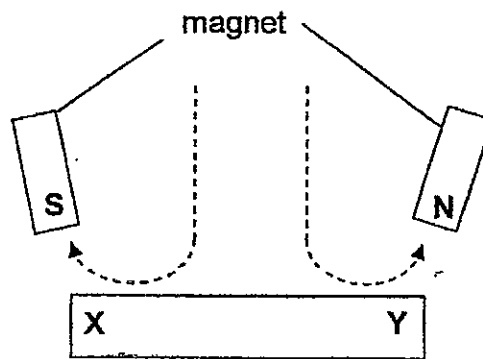

Diagram 3

(a) Identify the poles of the magnetised steel bar at X and Y respectively. [2]

(i) At X: \_\_\_\_\_

(ii) At Y: \_\_\_\_\_

- (b) Siti placed pins, one at a time, at part A, B and C of a bar magnet until no more pins could be attracted by it. She observed the following result shown in Figure 1.

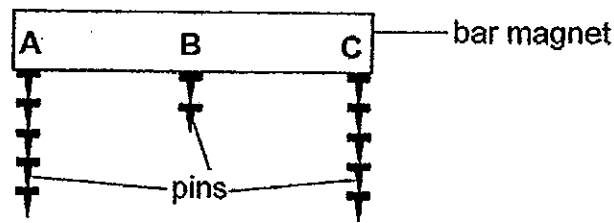

Figure 1

- (i) What can Siti conclude about the magnetic strength of the bar magnet based on the above observation? [1]

---



---

Siti was given two similar metal rods, J and K. One of the rods was a magnet and the other was a magnetic object. She wanted to find out which rod was the magnet.

Siti arranged the rods J and K as shown in Figure 2. She found that there was a strong magnetic pull between the rods. When she re-arranged the rods as shown in Figure 3, the magnetic pull between them was weak.

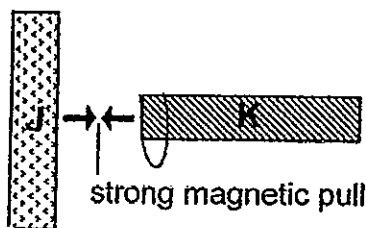

Figure 2

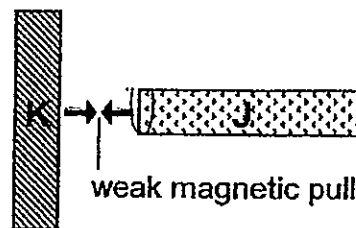

Figure 3

- (ii) Which rod, J or K, is the magnet? Give a reason for your answer. [1]

---



---



---

Score	2
-------	---



39. (a) David conducted an experiment to find out about magnetism in a science laboratory as shown below. The diagrams below showed the results of the experiment that he has observed.

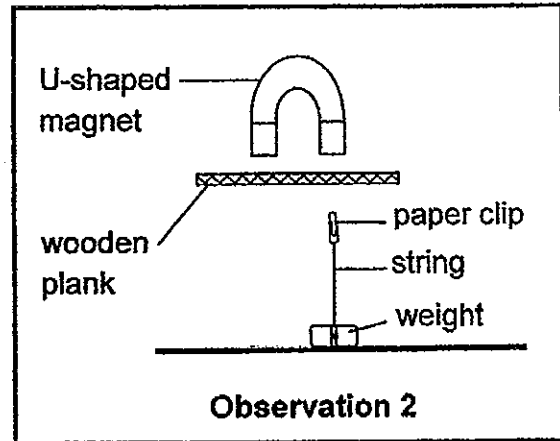
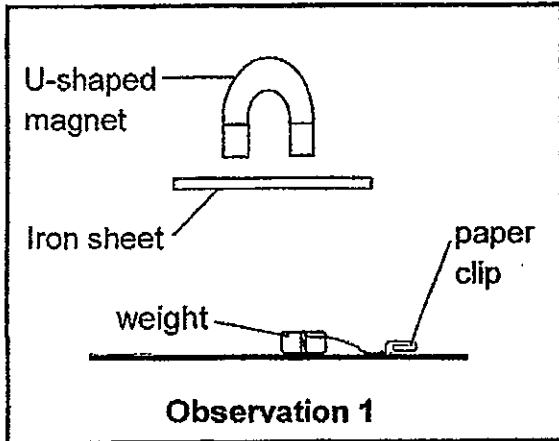

When David went home, he noticed that his mother left a piece of paper note on the door of the refrigerator. The note was held fast onto the door with the help of a magnet as shown below.

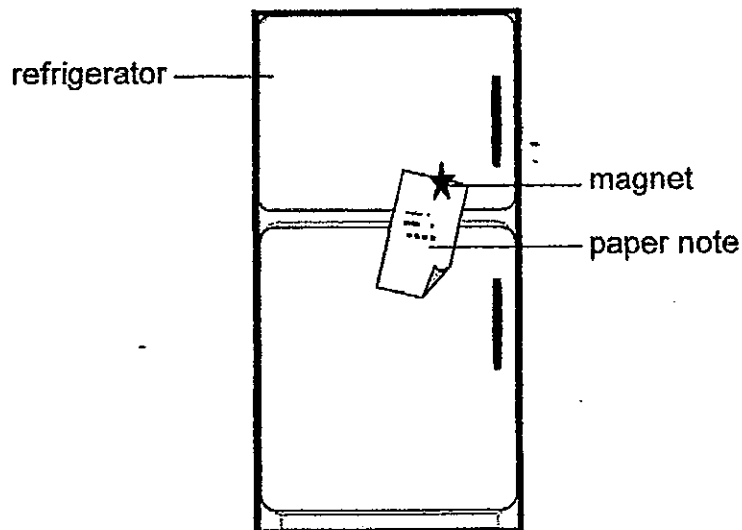

- (i) Name a material that the door of the refrigerator is most likely made of. [1]

---

- (ii) Give a reason why the magnet was able to hold a piece of paper on the door [1] of the refrigerator.

---



---

- (b) Jessica was given a large glass bowl containing a mixture of styrofoam balls, iron nails and pebbles as shown below.

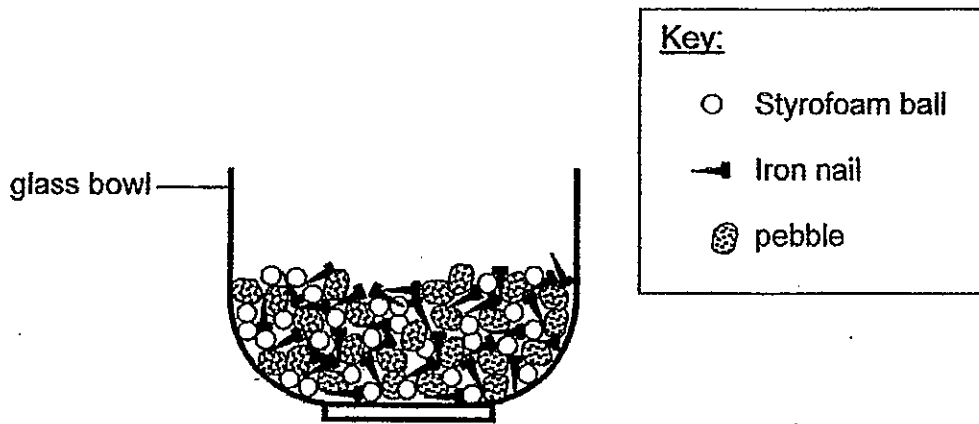

She was given a fish net, a magnet, a stirrer and 500 ml of water. She was then asked to separate all the three items in the glass bowl.

The four statements below describe what ~~Fatimah~~ <sup>Jessica</sup> could do to separate the items. [2]

Read the statements carefully. Write the number 1, 2, 3 and 4, in the box beside each statement to show the correct order that Jessica should follow to separate all the three items.

- |  | <u>Step</u>          |
|--|----------------------|
| (i) Pour away the water leaving behind only the pebbles.                 | <input type="text"/> |
| (ii) Scoop up the floating styrofoam balls with the fish net.            | <input type="text"/> |
| (iii) Pour water into the mixture and stir the mixture with the stirrer. | <input type="text"/> |
| (iv) Remove all the iron nails by using a magnet to attract them         | <input type="text"/> |

**END-OF-PAPER**

Score	2
-------	---

# ANSWER SHEET

**EXAM PAPER 2012**

**SCHOOL : RAFFLES GIRLS'  
SUBJECT : PRIMARY 4 SCIENCE**

**TERM : SA2**

Q1	Q2	Q3	Q4	Q5	Q6	Q7	Q8	Q9	Q10	Q11	Q12	Q13	Q14	Q15	Q16	Q17
2	3	2	4	2	2	4	1	4	2	4	3	4	4	3	4	3

Q18	Q19	Q20	Q21	Q22	Q23	Q24	Q25
4	3	4	2	3	3	4	2

26)F: Living things      G: Non-living things

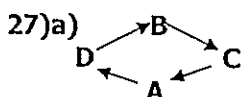

b)Animal A has 3 stages life cycle while mosquito has 4 stages life cycle.

28)a)1    b)4

29)a)Y

b)Food A.

c)Part W only contain undigested food.

30)a)i)leaf    ii)water

b)i)She was trying to find out if the root of the plants absorb water.

ii)It will still remain the same.

31)a)i)Pour same amount of water into the container.

ii)The strips of materials should be the same thickness.

b)i)It does not break easily and is flexible.

ii)Glass.

- 32)a)Solid  
b)Liquid

33)a)i)

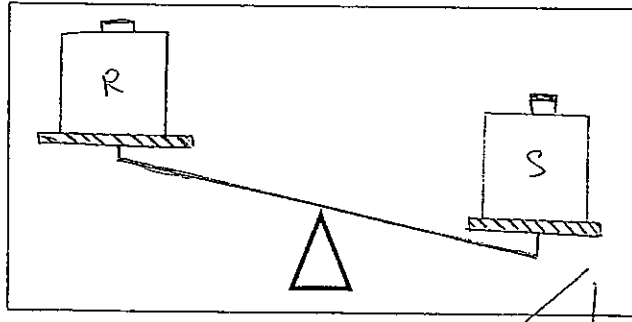

ii)Air has mass, if there are more air in the container, it will be heavier so it goes down.

b)3500cm<sup>3</sup>

34)a)Water sample D. It allows the most light to pass through so the plant will be able to receive plenty of light.

b)To ensure that the experiment is reliable.

35)a)poor      b)good

36)a)The water level will increase.

b)The temperature of the water will decrease. The metal will gain heat from the water.

c)29°C.

37)a)pull      b)magnetic

38)a)i)North-pole      ii)South-pole

b)i)The end poles A and C were the strongest part of the magnet.

ii)Rod K is the magnet. The center of the magnet is the weakest part so when a magnetic object is placed in the middle of the magnet, it will be a weak magnetic pull.

39)a)i)Steel.

ii)The material of the door of the refrigerator is a magnetic material and magnetism can pass through the paper so the magnet is able to attract a piece of paper on the door of the refrigerator.

b)i)4      ii)2      iii)1      iv)3