

NANYANG PRIMARY SCHOOL

PRIMARY FOUR SCIENCE

SEMESTRAL ASSESSMENT 2

2012

**BOOKLET A**

Date : 11 October 2012

Duration : 1 h 45 min

Name : \_\_\_\_\_ (     )

Class: Primary 4 (     )

Parent's signature: \_\_\_\_\_

**DO NOT OPEN THIS BOOKLET UNTIL YOU ARE TOLD TO DO SO.  
FOLLOW ALL INSTRUCTIONS CAREFULLY.**

Booklet A consists of 20 printed pages including this cover page.

**Section A (30 x 2 marks = 60 marks)**

For each question from 1 to 30, four options are given. One of them is the correct answer. Make your choice (1, 2, 3, or 4). Shade the correct oval (1, 2, 3 or 4) on the Optical Answer Sheet provided.

1. Which one of the animals shown below is not an insect?

(1)

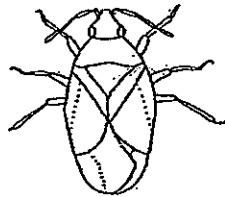

(2)



(3)

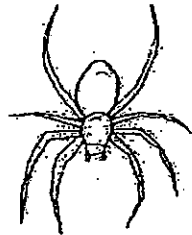

(4)



2. Which one of the following is the function of a leaf on a plant?

(1) Holds plant upright

(2) Makes food

(3) Takes in mineral salts

(4) Takes in water

3. What is the function of the large intestine?

(1) It removes digested food from the body.

(2) It allows water to be passed into the blood.

(3) It removes undigested food out of the body.

(4) It allows digested food to be passed into the blood.

4. The diagram below shows the life cycle of an animal.

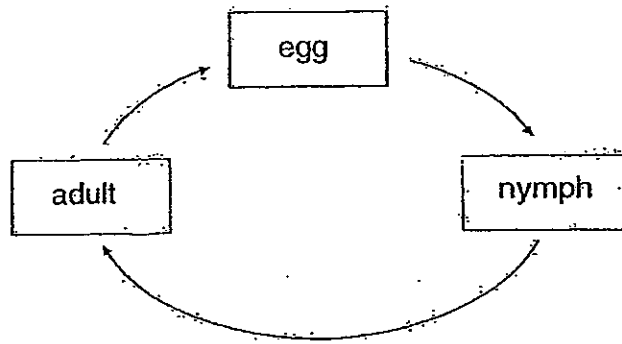

Which animal is likely to have the life cycle as shown above?

- (1) Beetle
- (2) Butterfly
- (3) Chicken
- (4) Cockroach

5. Peter shines a torch on the metal container as shown below.

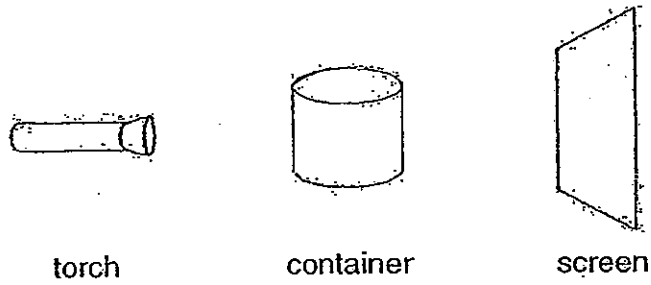

Which one of the following shows the shadow of the metal container on the screen?



6. Kerin places an ice cube into a glass of hot water.

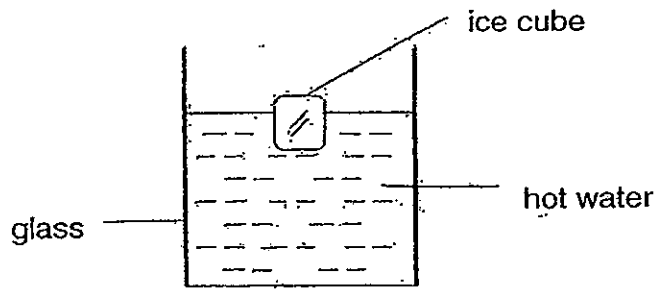

Which one of the following is correct?

- (1) The ice cube loses heat to the hot water.
- (2) The ice cube does not gain or lose heat.
- (3) The hot water loses heat to the ice cube.
- (4) The hot water gains heat from the ice cube.

7. Catherine wants to measure the temperature of hot water in a beaker.

Which one of the following diagrams shows the best position of the thermometer when taking the temperature reading?

(1)

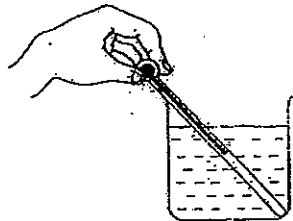

(2)

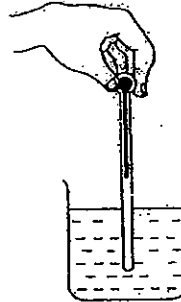

(3)

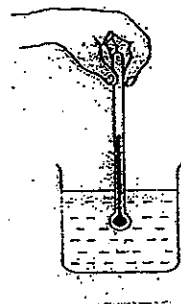

(4)

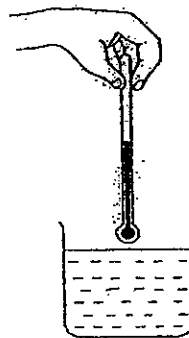

8. Which one of the following properties is true for both air and a pencil?

- (1) They can be seen.
- (2) They take up space.
- (3) They have fixed shapes.
- (4) They have fixed volumes.

9. Which one of the following objects can be bent easily without breaking?

- (1) A sheet of glass
- (2) A plastic spoon

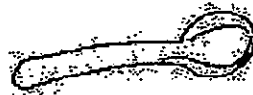
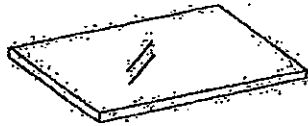

- (3) A towel
- (4) A wooden ruler

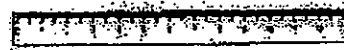
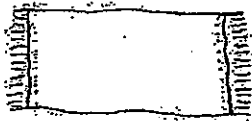

10. Which one of the following can be attracted by a magnet?

- (1) Steel ball
- (2) Rubber ball
- (3) Plastic ball
- (4) Wooden ball

11. Which of the following is not an example of a source of heat?

- (1) A burning candle
- (2) A cup of hot water
- (3) A lighted matchstick
- (4) A woollen sweater

12. The table below describes two different animals, X and Y, which lay eggs.

| Descriptions                       | X             | Y               |
|------------------------------------|---------------|-----------------|
| Number of stages in the life cycle | Three         | Four            |
| Number of legs                     | More than two | Less than eight |

Which of the following correctly represents animals X and Y?

|     | X               | Y           |
|-----|-----------------|-------------|
| (1) | Toad            | Cockroach   |
| (2) | Frog            | Mosquito    |
| (3) | Chicken         | Grasshopper |
| (4) | Mealworm Beetle | Moth        |

13. Three of the four stages in the life cycle of a butterfly are listed below.

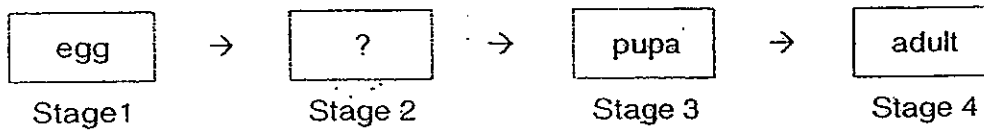

Which of the following diagrams below shows stage 2 of the life cycle of the butterfly?

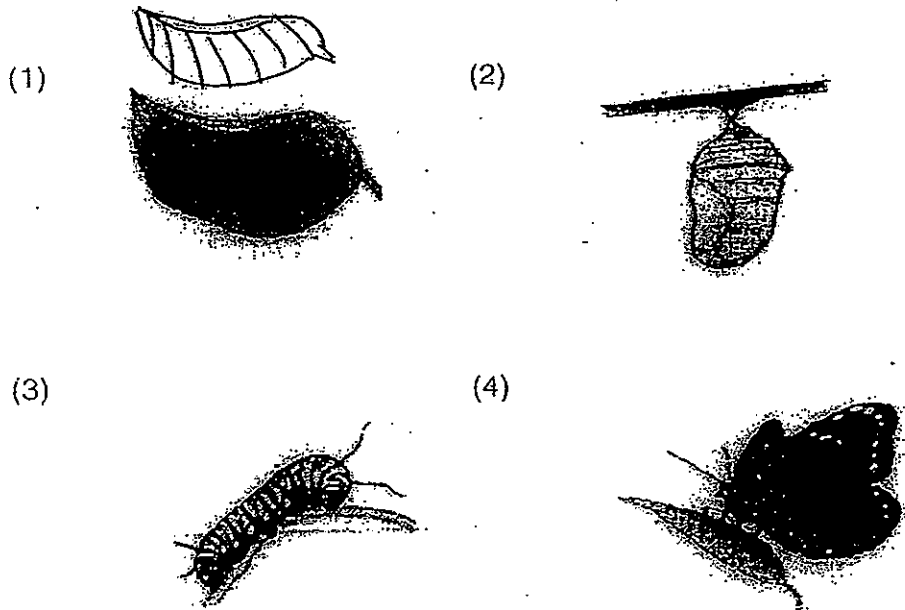

14. On a sunny day, the length of the shadow of a lamppost was taken at hourly intervals from 7 am to 5 pm. The data collected was used to plot a graph.

Which one of the following graphs shows the results obtained?

(1)

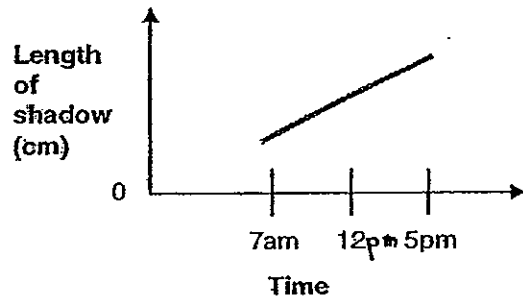

(2)

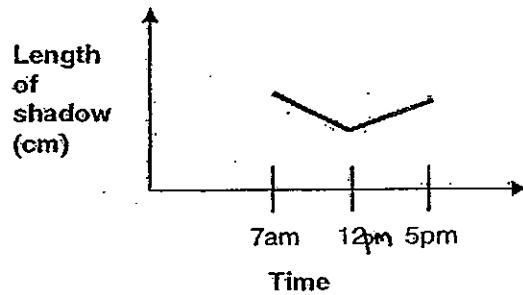

(3)

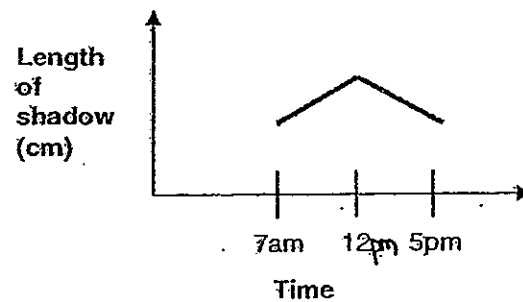

(4)

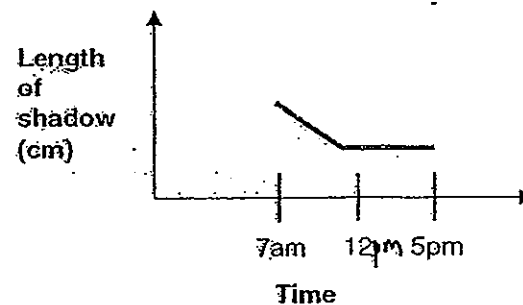

15. The diagram below shows the set-up which Timothy used to carry out an investigation.

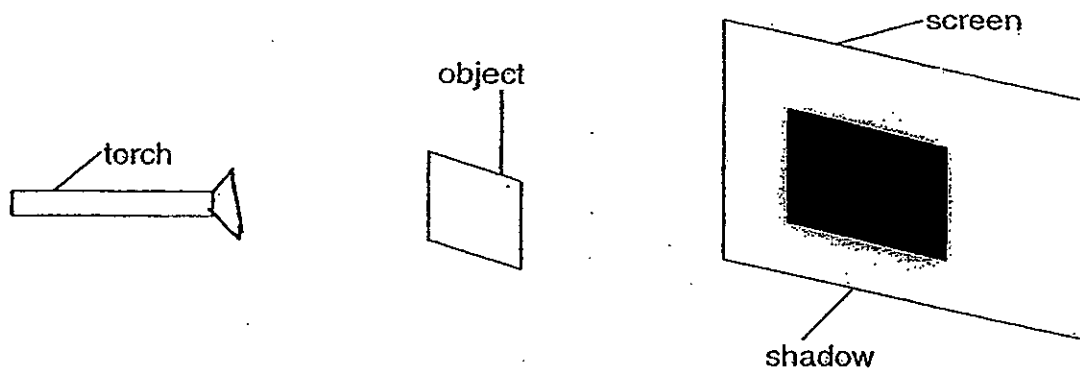

He switched on the torch and observed the size of the shadow formed on the screen.

Actions A to C list the changes that he could make to the set-up above.

- A Move the object nearer to the screen
- B Move the screen further from the object
- C Move the object nearer to the light source

Which of the actions above would **enlarge the size of the shadow** on the screen?

- (1) A and B only
- (2) A and C only
- (3) B and C only
- (4) A, B and C



16. The diagram below shows how the apple is seen through the periscope.

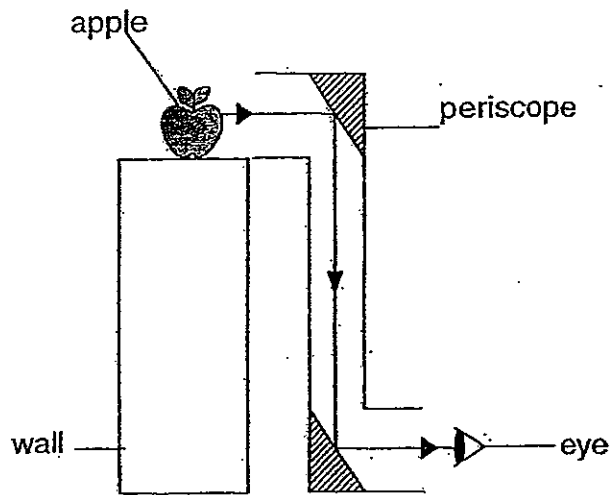

A, B and C states the properties of light

- A Light travels in straight lines.
- B Light can be reflected by mirrors.
- C When light is blocked, shadow is formed.

What of the above properties of light enable the eye to see the apple through the periscope?

- (1) A and B only
- (2) A and C only
- (3) B and C only
- (4) A, B and C

17. Study the classification table shown below.

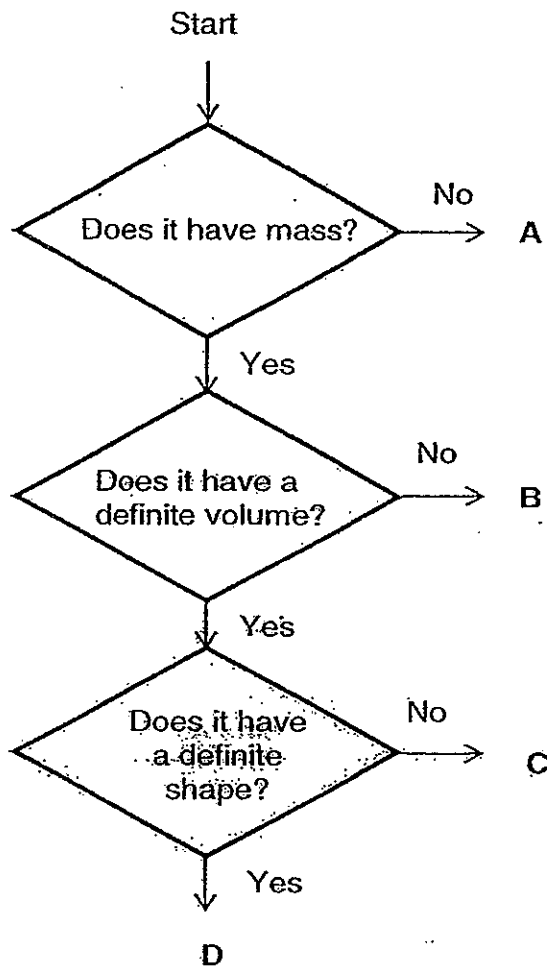

Which one of the following correctly states what items A, B, C and D could be?

|     | A      | B      | C      | D      |
|-----|--------|--------|--------|--------|
| (1) | Shadow | Oxygen | Water  | Wood   |
| (2) | Shadow | Wood   | Oxygen | Water  |
| (3) | Water  | Oxygen | Shadow | Wood   |
| (4) | Oxygen | Water  | Wood   | Shadow |

18. Which one of the following will show a change in the state of matter?

- (1) Heating air
- (2) Boiling some water.
- (3) Burning a piece of paper
- (4) Chopping a piece of wood.

19. Which one of the following shows the correct classification of objects?

|     | Opaque        | Translucent   | Transparent   |
|-----|---------------|---------------|---------------|
| (1) | Tracing paper | Cardboard     | Clear glass   |
| (2) | Clear glass   | Frosted glass | Cardboard     |
| (3) | Cardboard     | Tracing paper | Clear glass   |
| (4) | Frosted glass | Clear glass   | Tracing paper |

20. Refer to the classification table below.

| Light Source | Not a light source |
|--------------|--------------------|
| moon         | mirror             |
| star         | glass              |
| torch        | candle flame       |

Which one of the following had been classified wrongly?

- (1) moon and candle flame
- (2) star and mirror
- (3) mirror and glass
- (4) torch and star

21. The diagram below shows Sarah and Simon reading a book in their living room.







Which one of the following statements explains why Sarah and Simon are able to see what they are reading?

- (1) The eyes give out light and is reflected on the book.
- (2) The book gives out light and is reflected into their eyes.
- (3) The light in the room enters their eyes and is reflected onto the book.
- (4) The light from the room shines onto the book and is reflected into their eyes.

22. Peter took his drinking mug and shone a torch on it from different directions.



Which one of the following shadows could not be formed?

- |   |  |
|---|--|
| (1)  | (2)  |
| (3)  | (4)  |

23. The diagram below shows a floor plan of a book store.

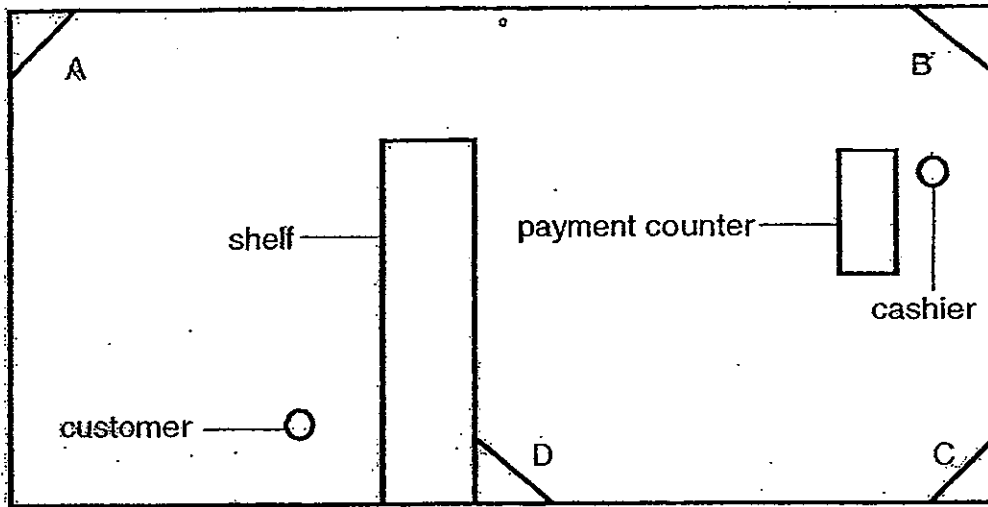

Two mirrors would be installed to enable the cashier to see any customer standing behind the shelf without leaving the payment counter.

Which of the options would be the best positions to install the mirrors?

- (1) Positions A and B
- (2) Positions A and C
- (3) Positions B and C
- (4) Positions B and D

24. The diagram below shows the set-up for Daniel's experiment. He used different materials for his experiment and conducted the experiment with each material three times.

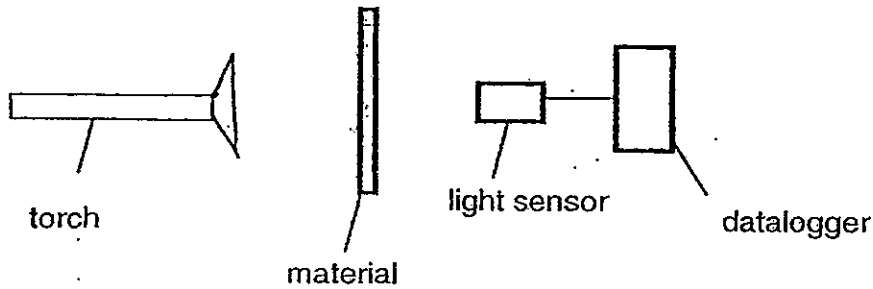

He recorded the readings from the datalogger as shown in the table below.

| Materials | 1 <sup>st</sup> try | 2 <sup>nd</sup> try | 3 <sup>rd</sup> try |
|-----------|---------------------|---------------------|---------------------|
| X         | 1200 lux            | 1224 lux            | 1210 lux            |
| Y         | 500 lux             | 510 lux             | 505 lux             |
| Z         | 5 lux               | 10 lux              | 8 lux               |

Based on his results, which one of the following could be the aim of his experiment?

- (1) To find out how bright the torch is.
- (2) To find out how much light the materials could reflect.
- (3) To find out how the number of tries affects the amount of light that pass through the material.
- (4) To find out how each material affects the amount of light that could pass through.

25. The diagram below shows the Sun shining on a stick placed on the ground.

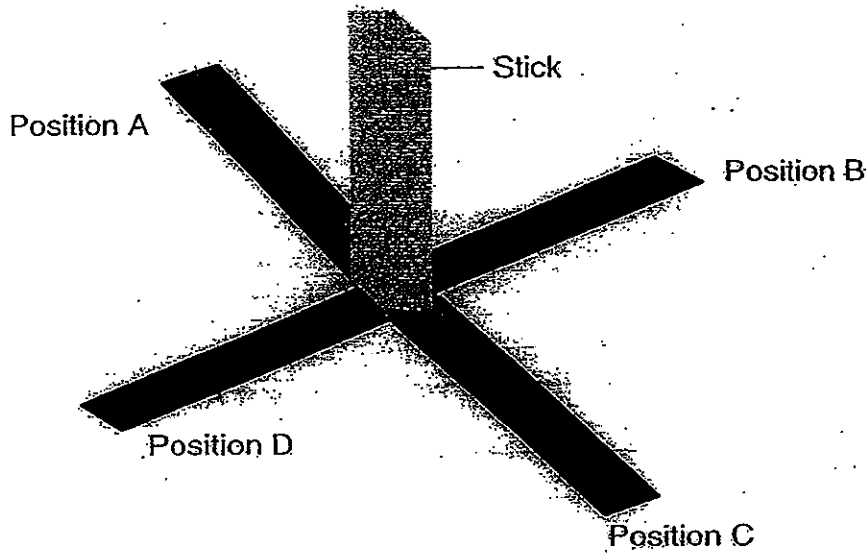
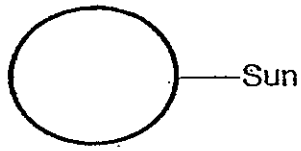

Which one of the following shadows shows the correct position of the shadow of the stick?

- |                |                |
|----------------|----------------|
| (1) Position A | (2) Position B |
| (3) Position C | (4) Position D |

26. John conducted an experiment as shown below.

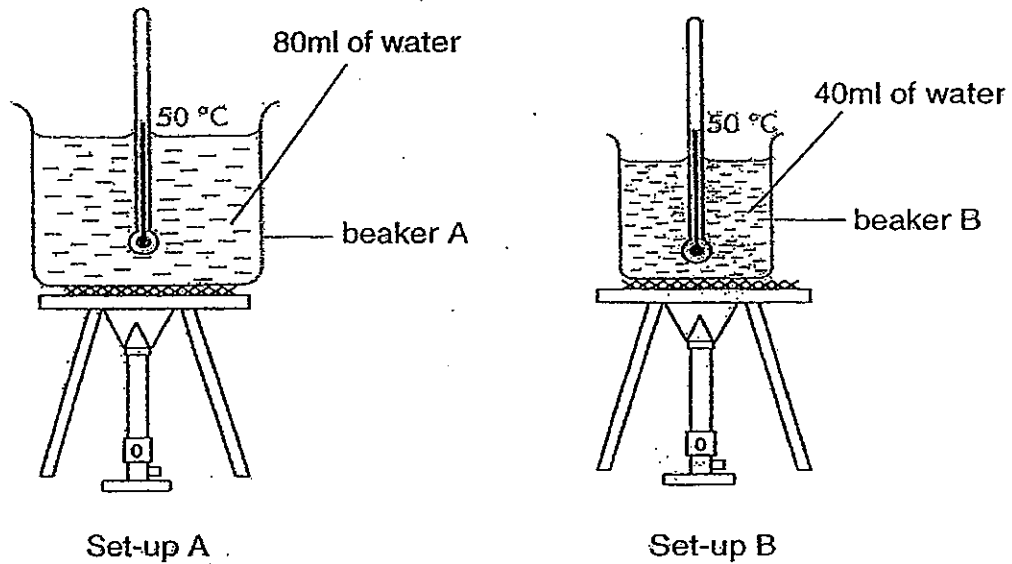

Beakers A and B were different in sizes. At the start of the experiment, the water in both beakers A and B were at 50°C. John heated the two beakers of water using the same amount of heat for ten minutes.

He predicted that the temperature of the water in beaker B would increase at a faster rate than the water in beaker A.

Which one of the following statements best explained John's prediction?

- (1) Water in beaker A was heated faster.
- (2) Beaker A was bigger in size than beaker B.
- (3) Less water in beaker B required a shorter time to heat up.
- (4) Water in beaker B had a higher temperature at the start of the experiment.



27. Andy tried to pull out the stopper from an empty bottle but was not able to do so. His mother suggested placing the bottle over a flame. Andy observed that the stopper popped out when the bottle was placed over the flame for a short time.

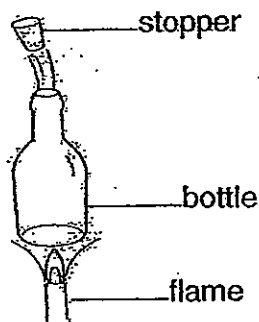

Which one of the following correctly explained his observation?

- (1) The bottle contracted when heated.
- (2) The stopper expanded when heated.
- (3) The air inside the bottle expanded and pushed the stopper out.
- (4) The air inside the bottle contracted and pushed the stopper out.

28. Ali prepared the experimental set-up below. He observed that the water level in the glass tubing decreased after ice cubes were added.

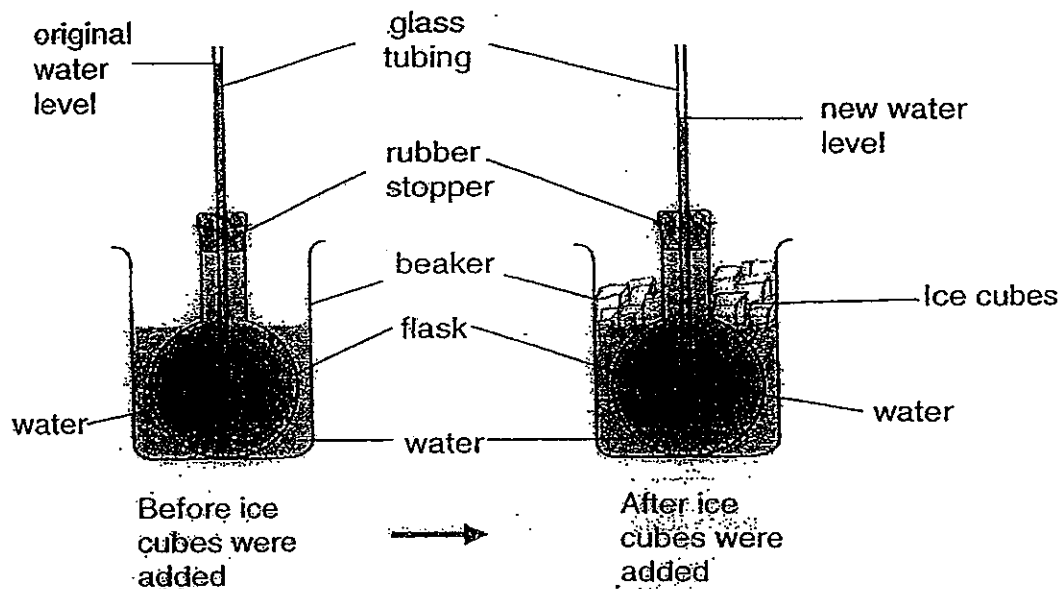

Which one of the following conclusions could be made based on the above observation?

- (1) The flask increased in volume when it was cooled.
- (2) The beaker decreased in volume when it was cooled.
- (3) Water in the flask increased in volume when it was cooled.
- (4) Water in the flask decreased in volume when it was cooled.

29. Ah Seng could not open a jar of jam because the lid was too tight.

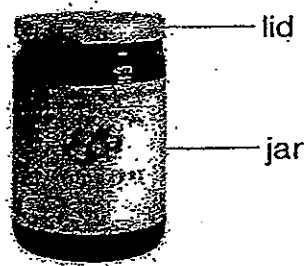

Which of the following shows the correct actions and explanation that would help Ah Seng to solve the problem?

|     | Action                                      | Explanation   |
|-----|---|---|
| (1) | Heat the lid over a flame.                  | The heat will cause the lid to contract and become loose.           |
| (2) | Pour hot water over the lid.                | The heat will cause the lid to expand and become loose.             |
| (3) | Heat the entire jar.                        | The heat will cause the lid and the jar to expand and become loose. |
| (4) | Immerse the bottom of the jar in hot water. | The heat will cause the jar to contract and make the lid tighter.   |

30. Railway tracks are built with small gaps in between them. These gaps allow the tracks to expand on a hot day. Without the gaps, the tracks will bend as they push against each other.

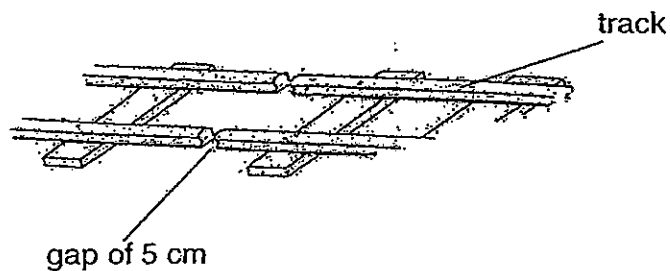

The table below shows how the length of different types of metals, A, B, C and D, change when heated. The measurements of each type of metal are taken every minute for 5 minutes.

| Time (min) | Length of metal |     |     |     |
|------------|-----------------|-----|-----|-----|
|            | A               | B   | C   | D   |
| 0          | 2.0             | 2.0 | 2.0 | 2.0 |
| 1          | 2.2             | 2.0 | 2.4 | 2.1 |
| 2          | 2.4             | 2.1 | 2.8 | 2.2 |
| 3          | 2.6             | 2.1 | 3.2 | 2.3 |
| 4          | 2.8             | 2.2 | 3.6 | 2.4 |
| 5          | 3.0             | 2.2 | 4.0 | 2.5 |

Based on the information above only, which is the best type of metal that should be used to make the railway tracks?

- (1) Metal A
- (2) Metal B
- (3) Metal C
- (4) Metal D



NANYANG PRIMARY SCHOOL  
PRIMARY FOUR SCIENCE  
SEMESTRAL ASSESSMENT 2

2012

**BOOKLET B**

Date : 11 October 2012

Duration : 1 h 45 min

Name : \_\_\_\_\_ (     )

Class: Primary 4 (     )

Marks Scored:

|             |  |     |
|-------------|--|-----|
| Booklet A:  |  | 60  |
| Booklet B : |  | 40  |
| Total :     |  | 100 |

Parent's signature: ..... - .....

Any query on marks awarded should be raised by 25 October 2012.  
We seek your understanding in this matter as any delay in the  
confirmation of marks will lead to delays in the generation of results.

**DO NOT OPEN THIS BOOKLET UNTIL YOU ARE TOLD TO DO SO.**  
**FOLLOW ALL INSTRUCTIONS CAREFULLY.**

Booklet B consists of 15 printed pages including this cover page.

**Section B (40 marks)**

Write your answers to questions 31 to 44 in the spaces provided.  
Marks will be deducted for misspelt key words.

31. The diagram below shows two plants.

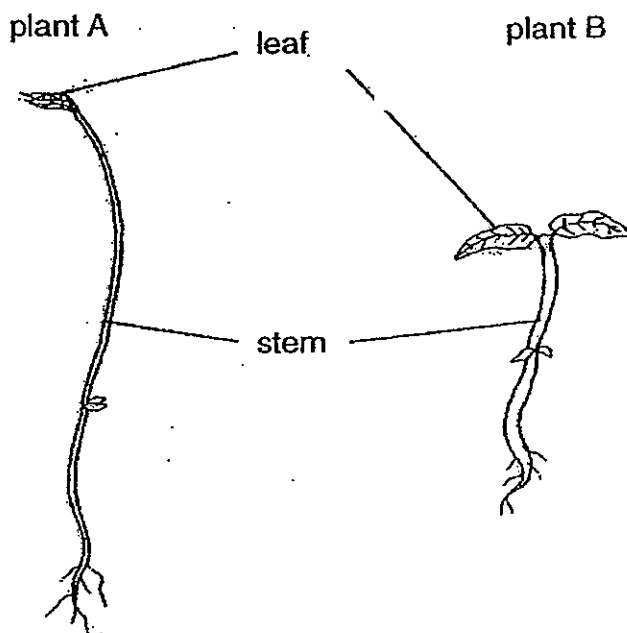

(a) What is one difference between the stem of plant A and the stem of plant B?

The stem of plant A is \_\_\_\_\_ than the stem of plant B. [1]

(b) The leaves help both plants make \_\_\_\_\_ in the presence of light. [1]

32. Choose the correct words from the box to answer the questions below.

|                 |       |                 |
|-----------------|-------|-----------------|
| gullet          | mouth | large intestine |
| small intestine |       | stomach         |

In a human digestive system, name the part where

(a) digestion first takes place : \_\_\_\_\_ [1]

(b) digestion is completed : \_\_\_\_\_ [1]

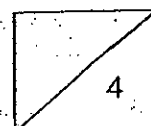

33. Susan placed a magnet near an iron rod. The iron rod moved towards the magnet.

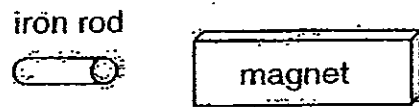

- (a) Magnet exerts a \_\_\_\_\_ on the iron rod. [1]
- (b) Choose the correct word from the box to answer the question below.

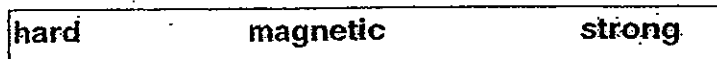

Susan's observation shows that iron is a \_\_\_\_\_ material. [1]

34. Ahmad sees **only** a candle flame at a corner when he enters a completely dark room.

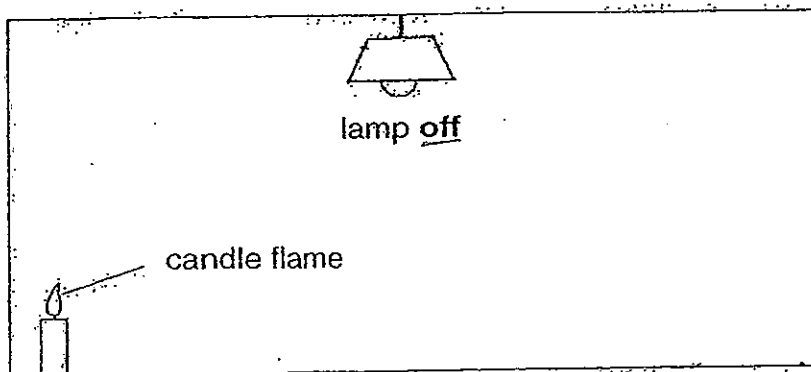

- (a) Ahmad can only see the candle flame because it \_\_\_\_\_ light. [1]

When he switches on the light in the room, he sees both the candle flame and object B.

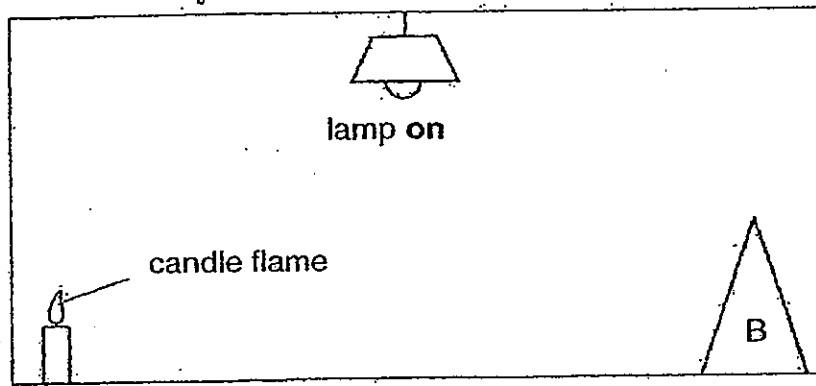

(b) Ahmad can see object B because it \_\_\_\_\_ light from the lamp. [1]

35. Jane used an instrument to measure the temperature of water in a glass.

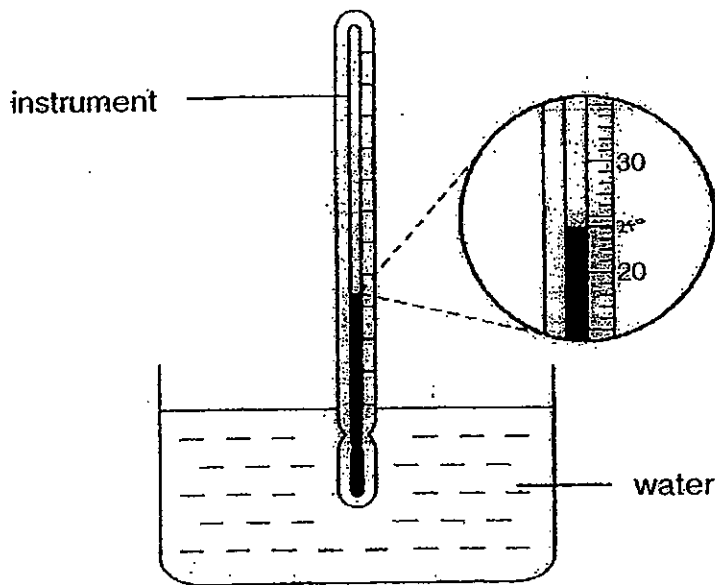

(a) What is the instrument called? [1]

\_\_\_\_\_

(b) What is the temperature of the water in the glass? [1]

\_\_\_\_\_ °C

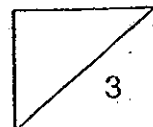



36. Ravi studied the life cycle of insect X as shown below and noted that the adult has wings.

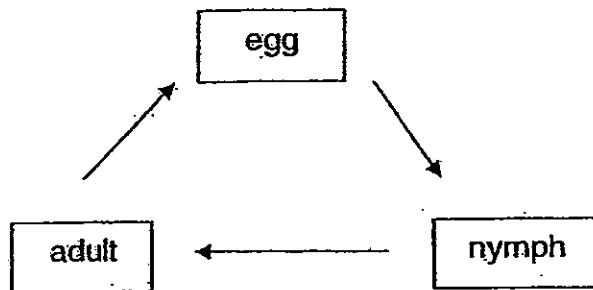

- (a) Ravi concluded that it was easiest to get rid of insect X at the egg stage. Explain how he arrived at this conclusion. [1]

---

---

- (b) Ravi found insect X in packets of sugar in the storeroom. His friend, Tom, suggested that he should spray insecticide on the packets of sugar so as to kill insect X immediately.

Provide a reason why Tom's suggestion could not be used. [1]

---

---

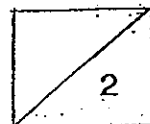

37. Below shows two objects, a metal triangular prism and a wooden rectangular frame.

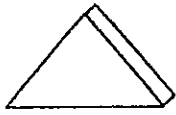

metal prism

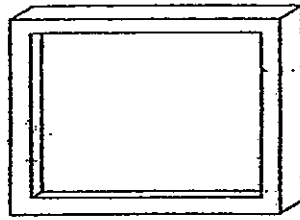

wooden frame

In the set-up below, Jane positioned a torch, the metal triangular prism and the wooden rectangular frame in front of a screen.

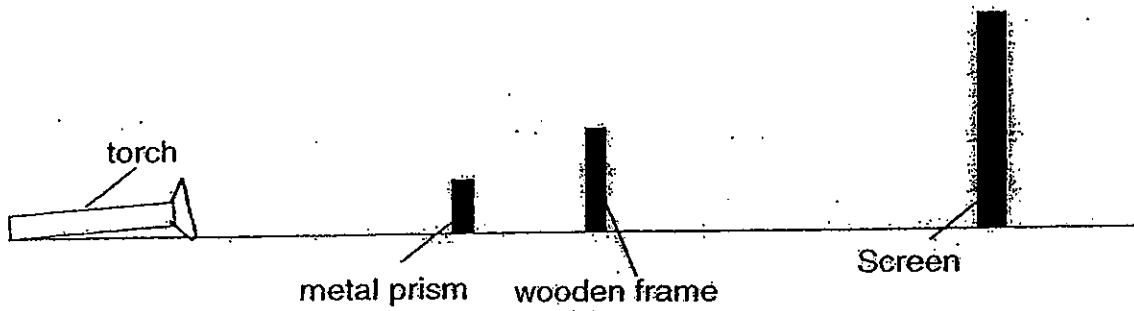

(a) In the box below, draw the shadow formed on the screen when light from the torch was shone at the 2 objects. [1]

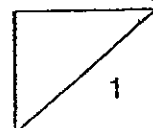
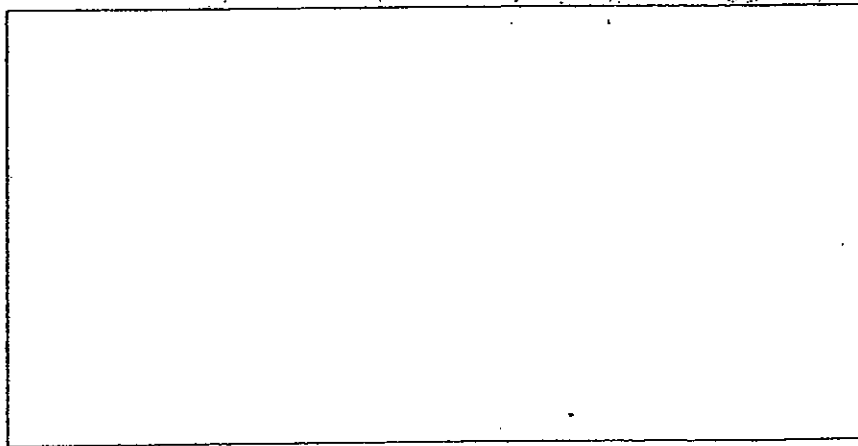

Jane decided to change the positions of the metal triangular prism with the wooden frame as shown below.

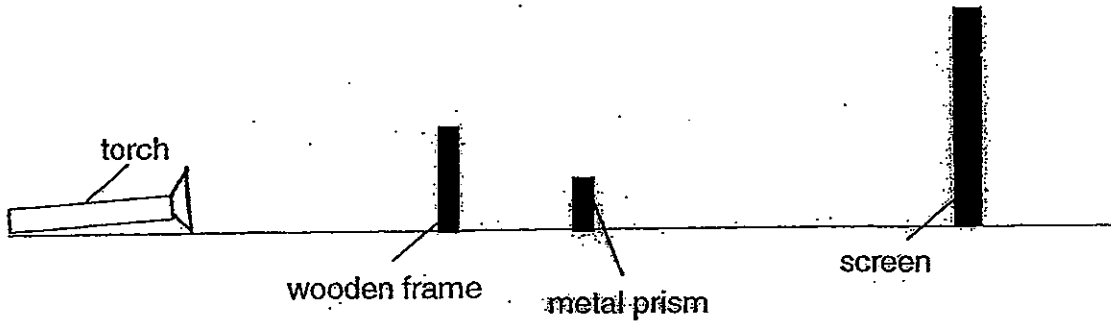

- (b) Explain the changes in the shadow formed by these objects on the screen. [1]

---



---

The diagrams below show the sun dial at 2 pm and 4 pm.

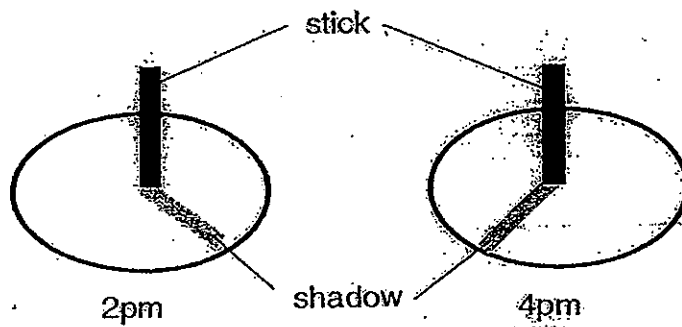

- (c) Draw the position of the shadow formed on the sun dial when it is 3 pm. [1]

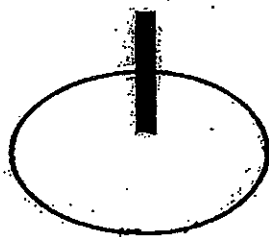

- (d) State two properties of light that allows shadows to be formed. [1]

---



---

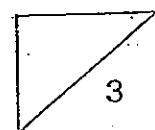

63

38. The set-up below shows a syringe that was filled with plasticine at its tip. When the plunger of the syringe was pushed, it was able to move forward for a short distance.

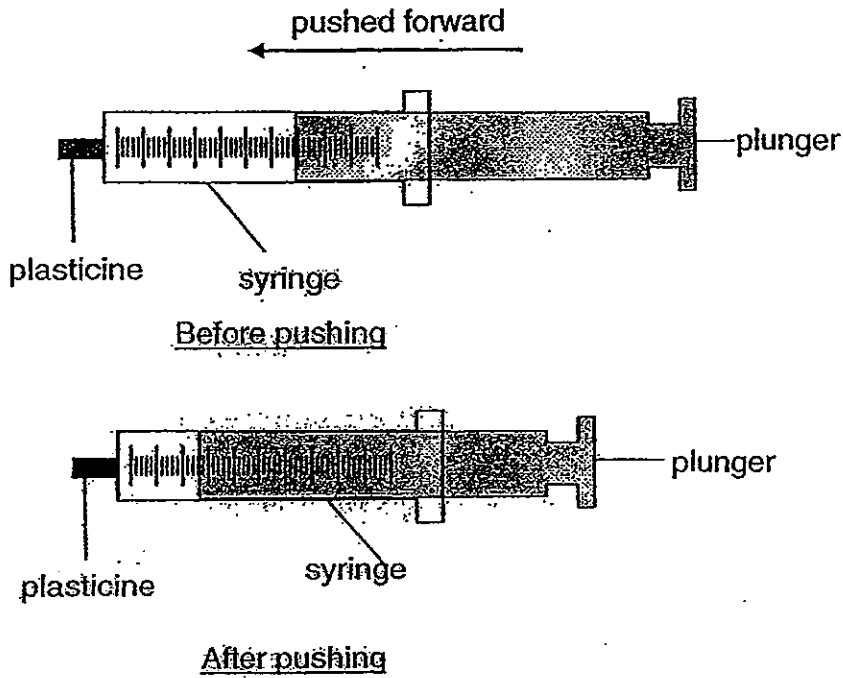

- (a) What can you conclude about the property of air from the investigation? [1]

---



---

- (b) Explain why the plunger could not be pushed to the tip of the syringe in the above set-up. [2]

---



---

- (c) State a change that could be made to the above set-up in order to allow the plunger to be pushed further towards the tip of the syringe. [1]

---



---

39. Linette carried out an experiment to find out how much light passed through 3 materials, X, Y and Z. She conducted the experiment using a light sensor attached to a datalogger.

She obtained the results as shown in the table below.

| Material | 1 <sup>st</sup> Reading (lux) | 2 <sup>nd</sup> Reading (lux) | 3 <sup>rd</sup> Reading (lux) |
|----------|-------------------------------|-------------------------------|-------------------------------|
| X        | 0                             | 0                             | 0                             |
| Y        | 245                           | 261                           | 256                           |
| Z        | 4900                          | 4950                          | 4980                          |
| None     | 5000                          | 5000                          | 5000                          |

Linette wanted to make some curtains for her windows to decorate her room. She also wants to be able to do her homework during the day without having to switch on her room lights.

Which material, X, Y or Z, should she use to make her curtains?  
Explain your answer based on the data that she had collected.

[2]

---

---

---

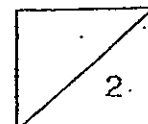

40. The diagram below shows the shadows cast by 2 blocks, A and B.

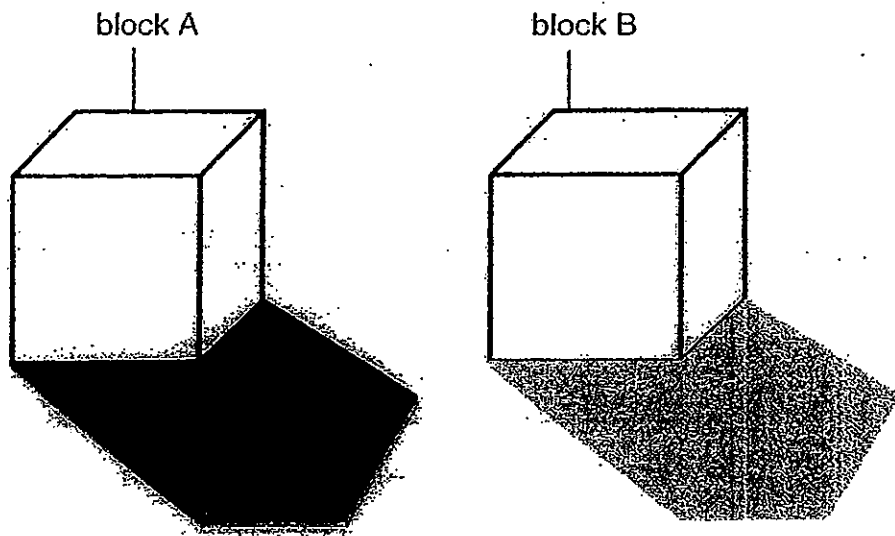
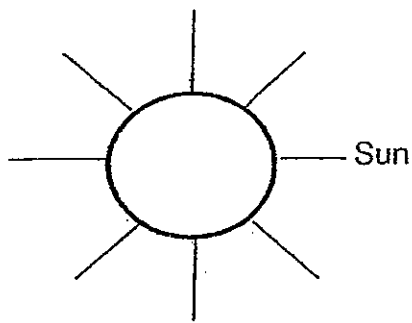

Block A was observed to cast a darker shadow than B.

- (a) Based on the results, suggest 2 materials each that blocks A and B could be made of. [2]

Block A: \_\_\_\_\_

Block B: \_\_\_\_\_

- (b) With reference to the material used to make blocks A and B, explain why block A cast a darker shadow than block B. [1]

\_\_\_\_\_  
\_\_\_\_\_

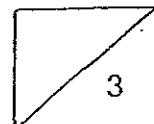

41. The diagram below shows an empty flask with a T-shape tube attached to a rubber stopper. There are two drops of ink in the tube. X represents the distance between the two drops of ink.

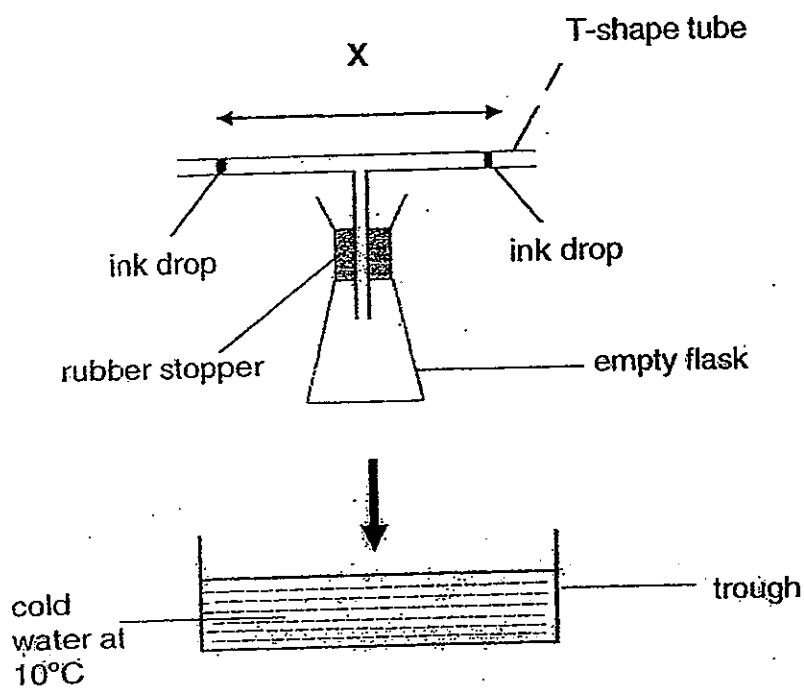

- (a)(i) State the change in X after the empty flask was immersed into the trough of cold water for 5 minutes. [1]

---

- (ii) Explain your answer for the change in X in part (i). [1]

---

---

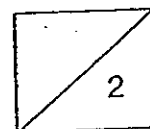

A hole was then made in the T-shaped tube at point Q.

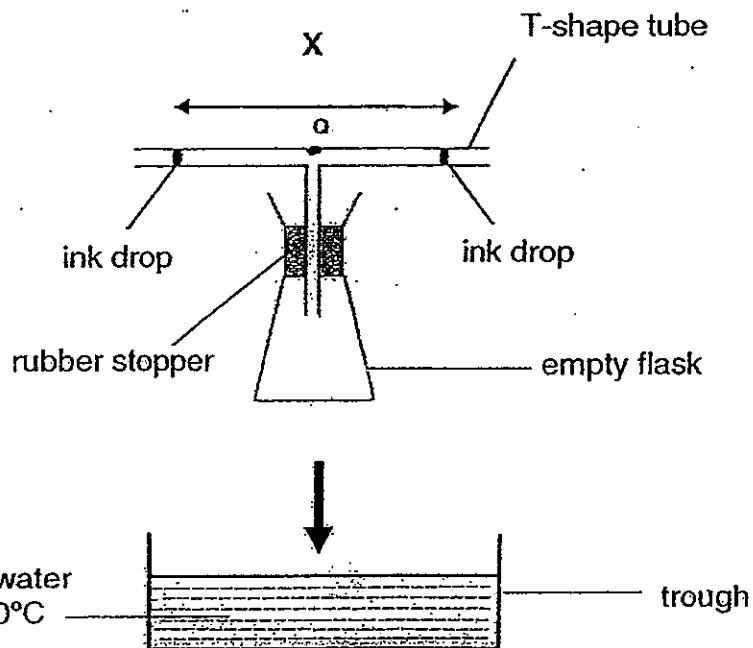

- (b) Explain why the ink drops no longer move when the empty flask was immersed in a trough of hot water. [2]

---

---

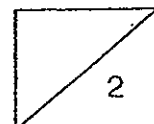



42. Mrs Raj wanted to conduct an experiment to show her class how the temperature of water affects the melting rate of an ice cube. She used four glass beakers, A, B, C and D containing water at different temperatures as shown below.

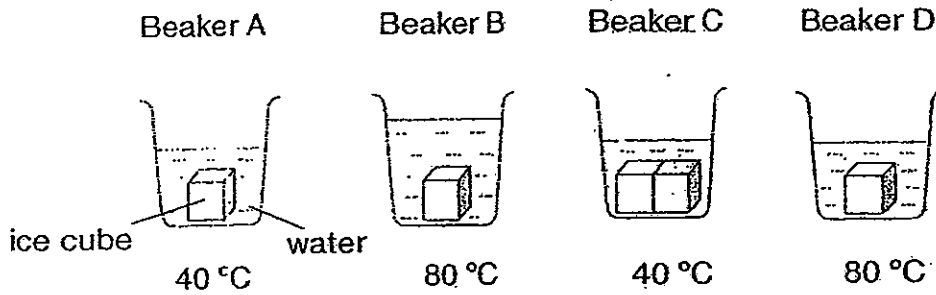

- (a) Her pupil suggested using beakers B and C to conduct the experiment but Mrs Raj said this would not be a fair test. Explain why she said so. [1]

---

---

- (b) Which two beakers should Mrs Raj use for the experiment to ensure a fair test? Give a reason for your answer. [2]

---

---

The pupils observed that when all the ice cubes had melted, the temperature of water in all the four beakers decreased.

- (c) Provide a reason to explain their observations. [1]

---

---

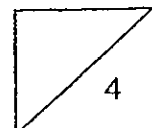

43. Gavin was given a thermometer and a cup of hot coffee.

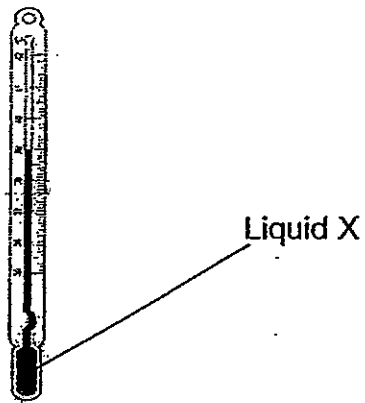

(a) What observation would Gavin make if he immersed the thermometer into the cup of hot coffee? [1]

---

(b) Give a reason for his observation in part (a). [2]

---

---

---

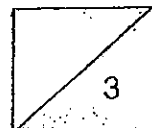

44. Alan conducted an experiment with the apparatus shown below. He placed a glass bottle with a deflated balloon into a basin of hot water. The balloon then became inflated.

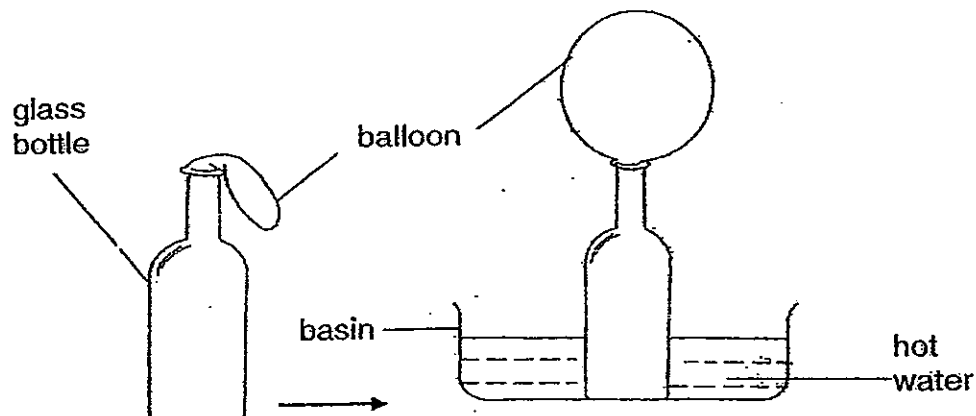

- (a) Explain why the balloon was inflated. [2]

---

---

- (b)(i) What can be done to the glass bottle above in order to deflate the balloon? [1]

---

---

- (b)(ii) State a reason for your answer in (b). [1]

---

---

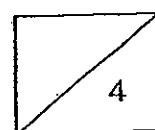



# ANSWER SHEET

**EXAM PAPER 2012**

**SCHOOL : NANYANG  
SUBJECT : PRIMARY 4 SCIENCE**

**TERM : SA2**

|    |    |    |    |    |    |    |    |    |     |     |     |     |     |     |     |     |
|----|----|----|----|----|----|----|----|----|-----|-----|-----|-----|-----|-----|-----|-----|
| Q1 | Q2 | Q3 | Q4 | Q5 | Q6 | Q7 | Q8 | Q9 | Q10 | Q11 | Q12 | Q13 | Q14 | Q15 | Q16 | Q17 |
| 3  | 2  | 2  | 4  | 2  | 3  | 3  | 2  | 3  | 1   | 4   | 2   | 3   | 2   | 3   | 1   | 1   |

|     |     |     |     |     |     |     |     |     |     |     |     |     |
|-----|-----|-----|-----|-----|-----|-----|-----|-----|-----|-----|-----|-----|
| Q18 | Q19 | Q20 | Q21 | Q22 | Q23 | Q24 | Q25 | Q26 | Q27 | Q28 | Q29 | Q30 |
| 2   | 3   | 1   | 4   | 1   | 1   | 4   | 3   | 3   | 3   | 4   | 2   | 2   |

31)a)taller                      b)food

32)a)mouth                      b)small intestine

33)a)pull                        b)magnetic

34)a)give off                    b)reflects

35)a)thermometer            b)24°C

36)a)As when it is an egg, the egg cannot move so it is the easiest to get rid of.  
b)The sugar will be poisoned by the insecticide)es.

37)a)

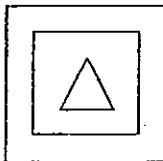

b)The size of the shadow cast by the wooden rectangular frame would be bigger. The size of the shadow cast by the metal triangular prism would be smaller.

37)c)

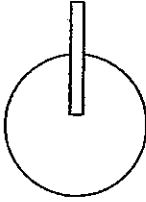

d) Light travels in a straight light.

38)a) Air can be compressed.

b) Air occupies space and it cannot be pushed any further.

c) Place the syringe into a basin of ice.

39)Z. It allows the most light to pass through among the three material.

40)a) A: Wood      B: Frosted glass

b) A does not allow any light to pass through while B allows some light to pass through and A allows less light to pass through than B.

41)a)i) X will become shorter.

ii) The air in the flask was cooled and contracted.

b) The air in the flask gained heat, expanded and escaped through the hole.

42)a) Beaker B has more water than beaker C and beaker C has one more ice cube.

b) A and D. They both have the same amount of water and the same number of ice cubes, only the temperature can be different.

c) The ice cube gained heat from the water and the water lost heat to the ice.

43)a) Liquid X would rise up.

b) The liquid X gains heat and expand, occupying more space in the thermometer.

44)a) The air inside the bottle gets heated and occupying more space in the balloon.

b) Put the glass bottle into a basin of cold water.

c) The air inside the glass bottle contracts and the balloon will be deflated.