

METHODIST GIRLS' SCHOOL (PRIMARY)

Founded in 1887



END-OF-YEAR EXAMINATION 2013 PRIMARY 4 MATHEMATICS BOOKLET A

Total Time: 1 h 45 minutes

INSTRUCTIONS TO CANDIDATES

Do not turn over this page until you are told to do so.
Follow all instructions carefully.
Answer all questions.

Name: _____ ()

Class: Primary 4. _____

Date: 8 OCTOBER 2013

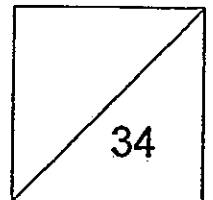

This booklet consists of 7 printed pages including this page.

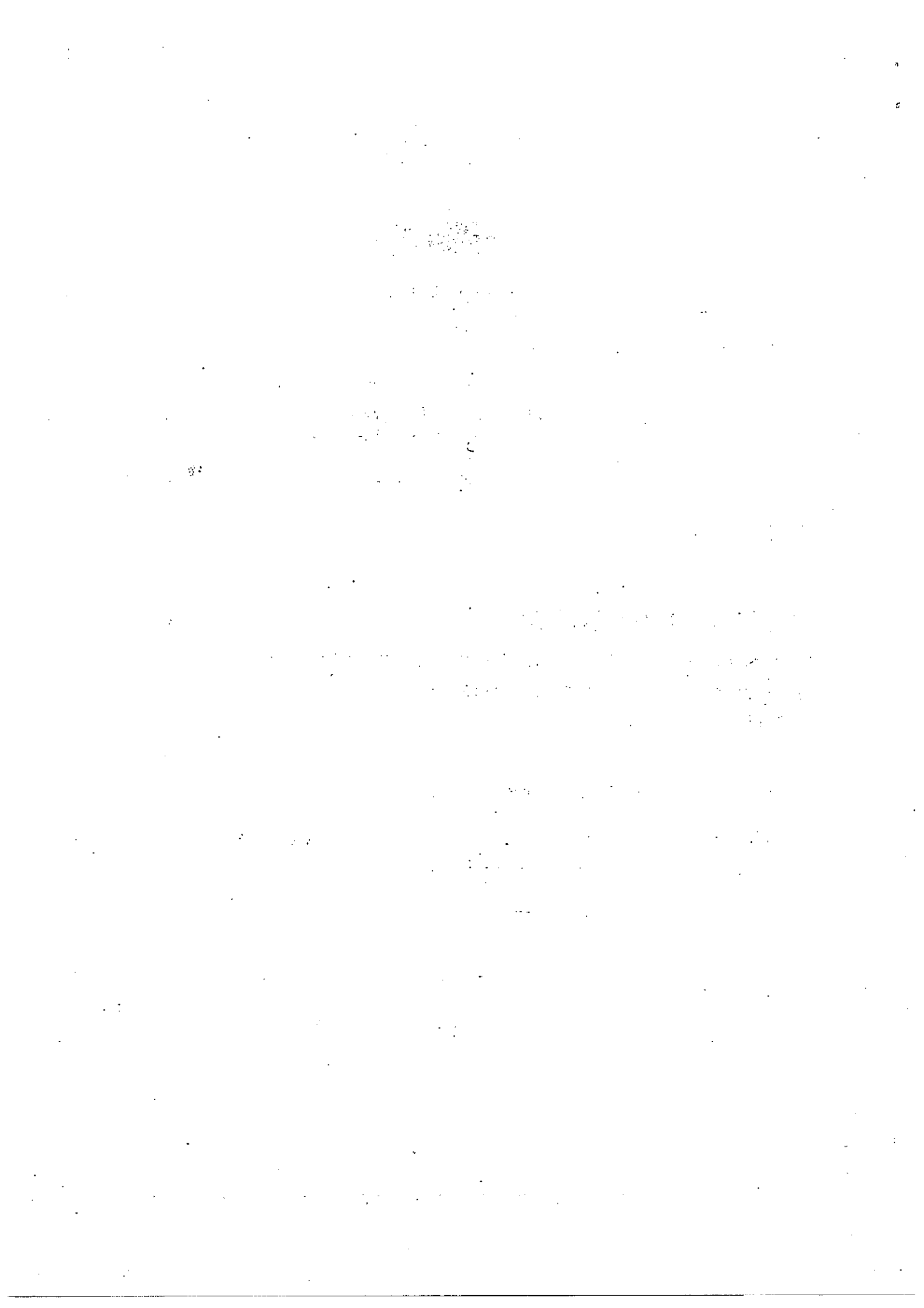

Section A

Questions 1 to 17 carry 2 marks each. For each question, four options are given. One of them is the correct answer. Make your choice (1, 2, 3 or 4). Shade the correct oval (1, 2, 3 or 4) on the Optical Answer Sheet. (34 marks)

1 Twenty-three thousand and eighteen in figures is _____.

- (1) 2 318
- (2) 23 018
- (3) 23 108
- (4) 23 180

2 23 568 rounded off to the nearest hundred is _____.

- (1) 23 500
- (2) 23 570
- (3) 23 600
- (4) 24 000

3 $7.05 = 7 + \frac{5}{\square}$. What is the missing number in the box?

- (1) 1
- (2) 10
- (3) 100
- (4) 1 000

4 Which one of the following has $\frac{2}{3}$ of the figure shaded?

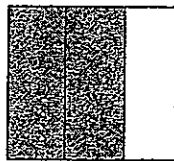

(1)

(2)

(3)

(4)

5 Which of the following is **not** an equivalent fraction of $\frac{1}{4}$?

(1) $\frac{2}{8}$

(2) $\frac{3}{12}$

(3) $\frac{5}{18}$

(4) $\frac{6}{24}$

6 What is the number when 138.74 is rounded off to 1 decimal place?

(1) 138.0

(2) 138.7

(3) 138.8

(4) 139.0

7 3 right angles are _____ of a complete turn.

(1) $\frac{3}{8}$

(2) $\frac{3}{4}$

(3) $\frac{1}{4}$

(4) $\frac{1}{2}$

Study the graph carefully and answer questions 8 and 9.
The graph below shows the number of library books borrowed by 5 children.

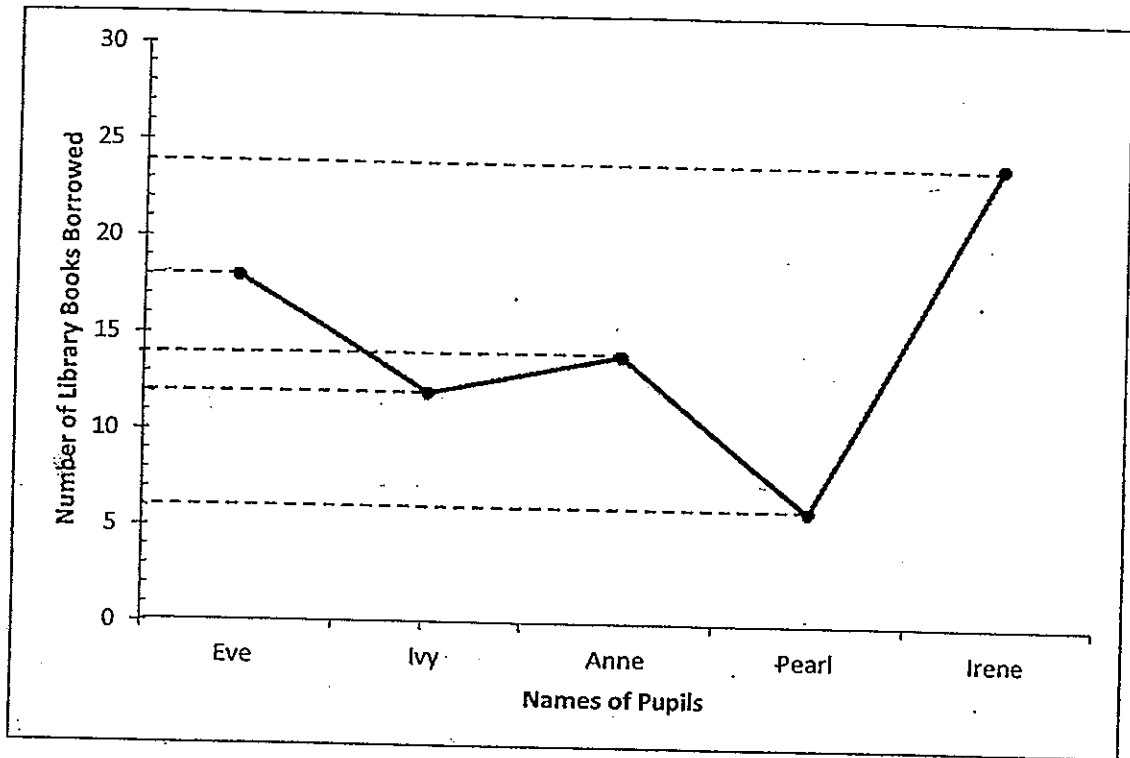

- 8 Who borrowed twice as many story books as Ivy?
- (1) Eve
 - (2) Anne
 - (3) Pearl
 - (4) Irene
- 9 What is the total number of library books borrowed by Anne and Pearl?
- (1) 74
 - (2) 20
 - (3) 14
 - (4) 70

- 10 Mr Tan came home from his evening walk at 7 p.m. He had walked for 1 h 45 min. At what time did he leave his house?

- (1) 1715
- (2) 1515
- (3) 0555
- (4) 0515

- 11 Pete is facing the Police Post. He made a 135° turn clockwise. Where is he facing now?

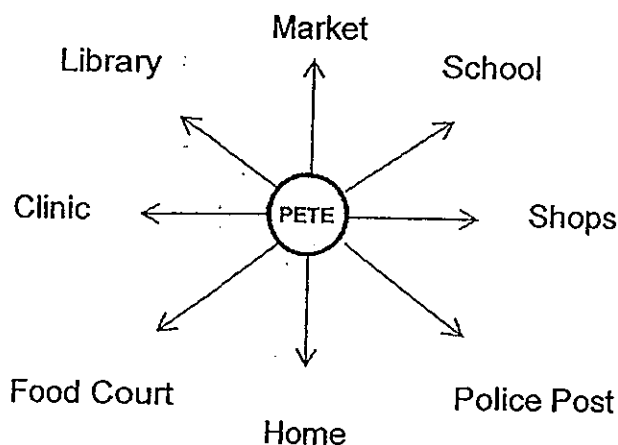

- (1) Clinic
- (2) Library
- (3) Market
- (4) School

- 12 May has \$15. She bought a book for \$12.75. How much has she left?

- (1) \$2.25
- (2) \$2.35
- (3) \$3.25
- (4) \$3.75

13 $17.48 \div 6 \approx$ _____

- (1) 0.29
- (2) 2.90
- (3) 2.91
- (4) 2.96

- 14 The figure below is made of 3 identical squares of length 4 cm.

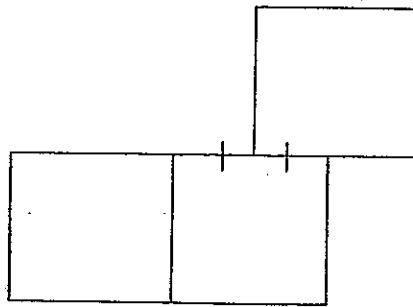

What is the perimeter of the figure?

- (1) 12 cm
 (2) 28 cm
 (3) 36 cm
 (4) 48 cm
- 15 Which one of the following shapes cannot be tessellated?



Figure 1

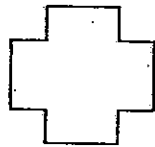

Figure 2

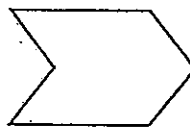

Figure 3

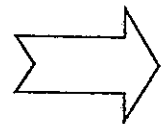
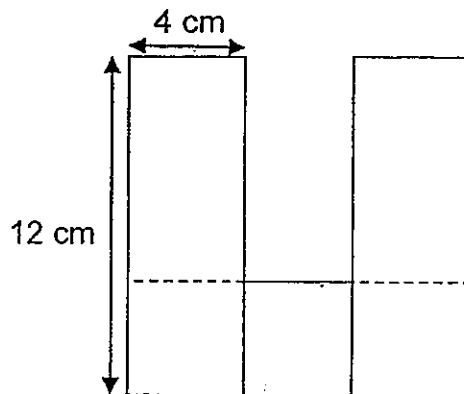

Figure 4

- (1) 1
 (2) 2
 (3) 3
 (4) 4

- 16 3 identical rectangles with dimensions 12 cm by 4 cm were used to form the figure as shown below. Find the perimeter of the figure.



- (1) 54 cm
 (2) 60 cm
 (3) 64 cm
 (4) 72 cm
- 17 An envelope measuring 20 cm by 11 cm has a stamp 4.5 cm by 2 cm pasted on its top right hand corner and a rectangular sticker 6 cm by 3 cm with the name and address of the receiver pasted on it. What is the area of the envelope not covered by the sticker and stamp?

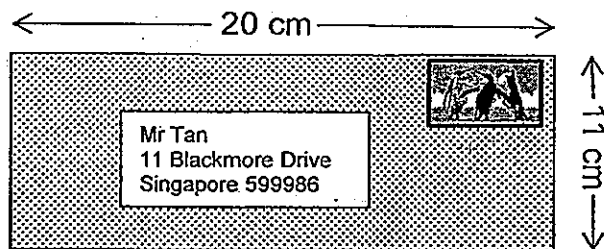

- (1) 220 cm²
 (2) 211 cm²
 (3) 202 cm²
 (4) 193 cm²

METHODIST GIRLS' SCHOOL (PRIMARY)

Founded in 1887



END-OF-YEAR EXAMINATION 2013 PRIMARY 4 MATHEMATICS BOOKLET B

Total Time: 1 h 45 minutes

INSTRUCTIONS TO CANDIDATES

Do not turn over this page until you are told to do so.
Follow all instructions carefully.
Answer all questions.

Name: _____ ()

Class: Primary 4. _____

Date: 8 OCTOBER 2013

BOOKLET A	34
BOOKLET B	36
BOOKLET C	20
TOTAL	90

This booklet consists of 9 printed pages including this page.

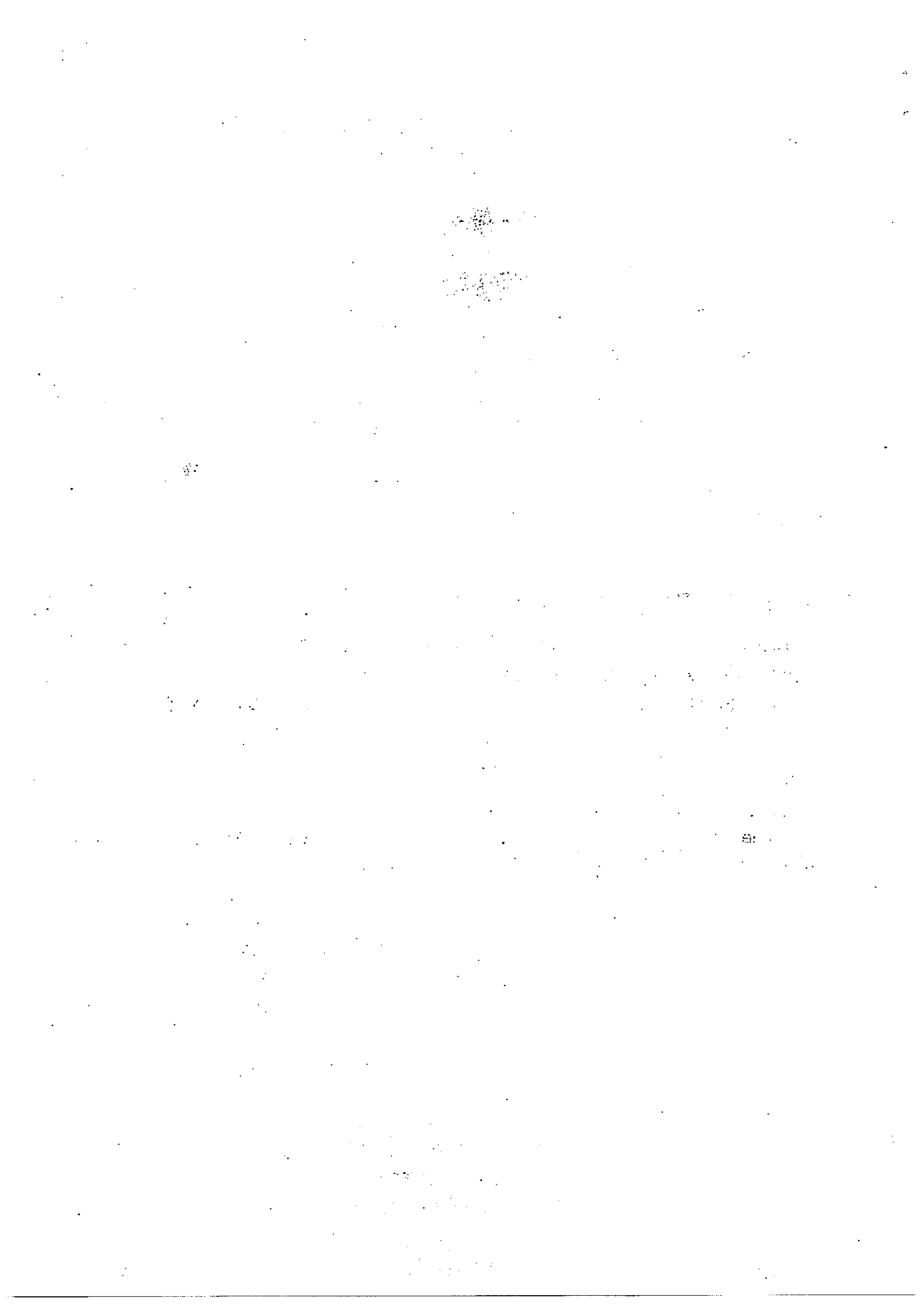

Section B

Questions 18 to 35 carry 2 marks each. Write your answers in the space provided. For questions which require units, give your answers in the units stated. (36 marks)

18. Write the missing number in the number pattern below.

12 000, 11 300, 10 600, 9 900, _____, 8 500

Ans: _____

19 What number is 100 more than 8 985?

Ans: _____

20 Some factors of 24 are 1, 2, 3, 4, 6, 24. What are the other two factors of 24?

Ans: _____ and _____

- 21 Write $\frac{14}{4}$ as a mixed number in its simplest form.

Ans: _____

- 22 What is the value of $1 - \frac{1}{8} - \frac{1}{4}$?

Ans: _____

- 23 Arrange the following numbers in order from the smallest to the greatest.

$$\frac{2}{5}, 0.405, 0.045$$

smallest

greatest

- 24 Write the decimal represented by A.

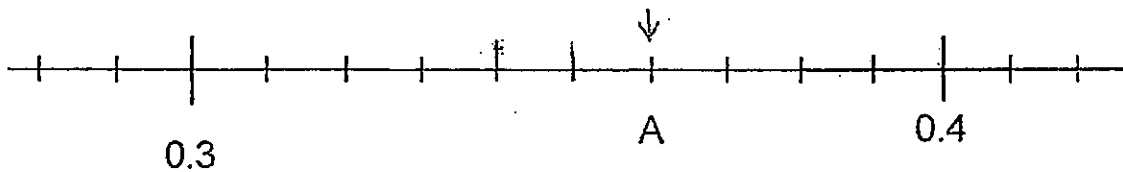

Ans: _____

- 25 In the clock face below, draw in the hour and minute hands to show 1630.

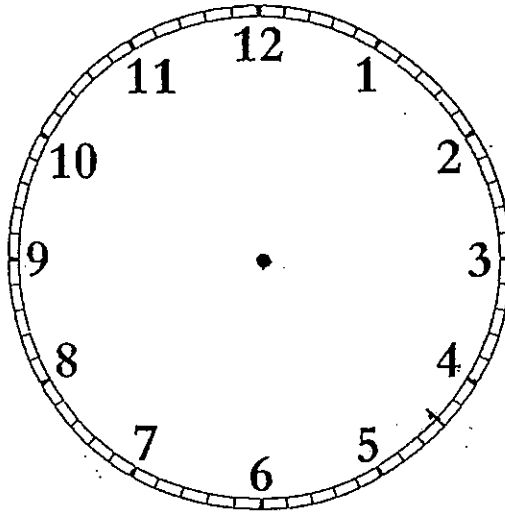

Study the table below carefully and answer questions 26 and 27.

The table below shows two mobile phone subscription plans offered by SingSong Company.

	Outgoing Local Calls	Incoming Calls	Local SMS	Local Data	Monthly Subscription
<i>Flexi SuperLite</i>	100 mins	FREE	Free 500	100MB	\$27.90
<i>Flexi Lite</i>	100 mins	FREE	Free 800	2GB	\$39.90

Adapted from SingTel Price Plans

- 26 a) What is the difference in monthly subscription between Flexi SuperLite and Flexi Lite?

Ans: \$ _____

- b) How much would you save in subscription if you sign up for Flexi SuperLite instead of Flexi Lite for a year?

Ans: \$ _____

- 27 Under the Flexi SuperLite plan, how much must you pay for the SMSes in a month if you send 550 local SMSes? Every extra SMS is charged at \$0.20.

Ans: \$ _____

(Go on to the next page)

- 28 When it is 1200 in Singapore, it is 1100 in Bangkok. A plane left Singapore and arrived at Bangkok at 1430. What was the time in Singapore when the plane landed in Bangkok? (Give your answer using the 24-hour clock)

Ans: _____

- 29 In the figure, one of the lines is parallel to AB. Which line is parallel to AB?

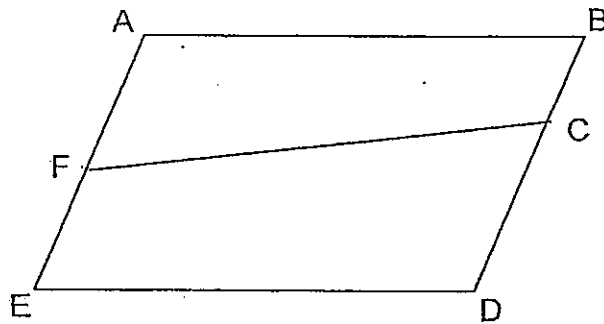

Ans: _____

- 30 In the figure shown, ABCD is a rectangle. Find $\angle FDE$.

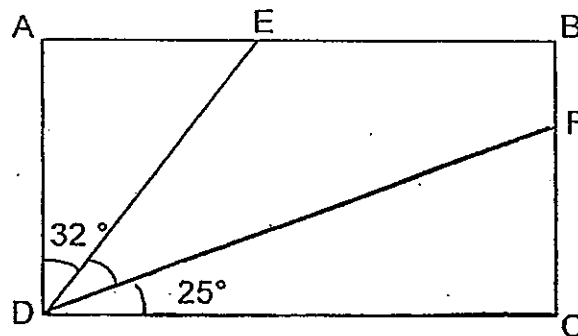

Ans: _____°

- 31 Draw a line that is perpendicular to AB passing through X .

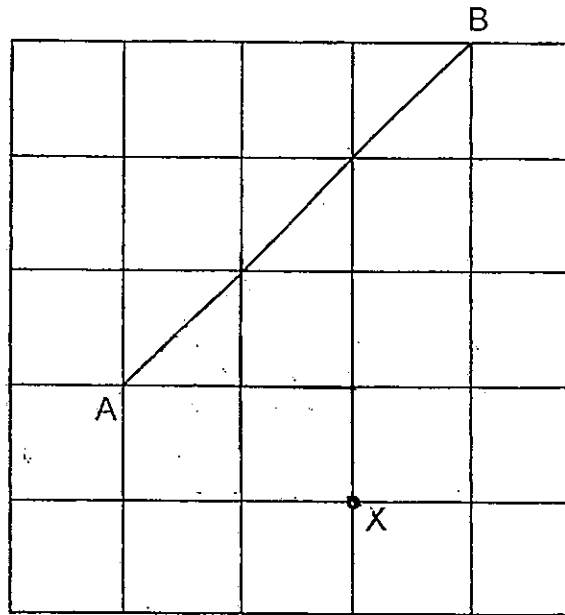

- 32 The dotted line in the following is a line of symmetry.
Shade the correct squares to make a symmetrical pattern.

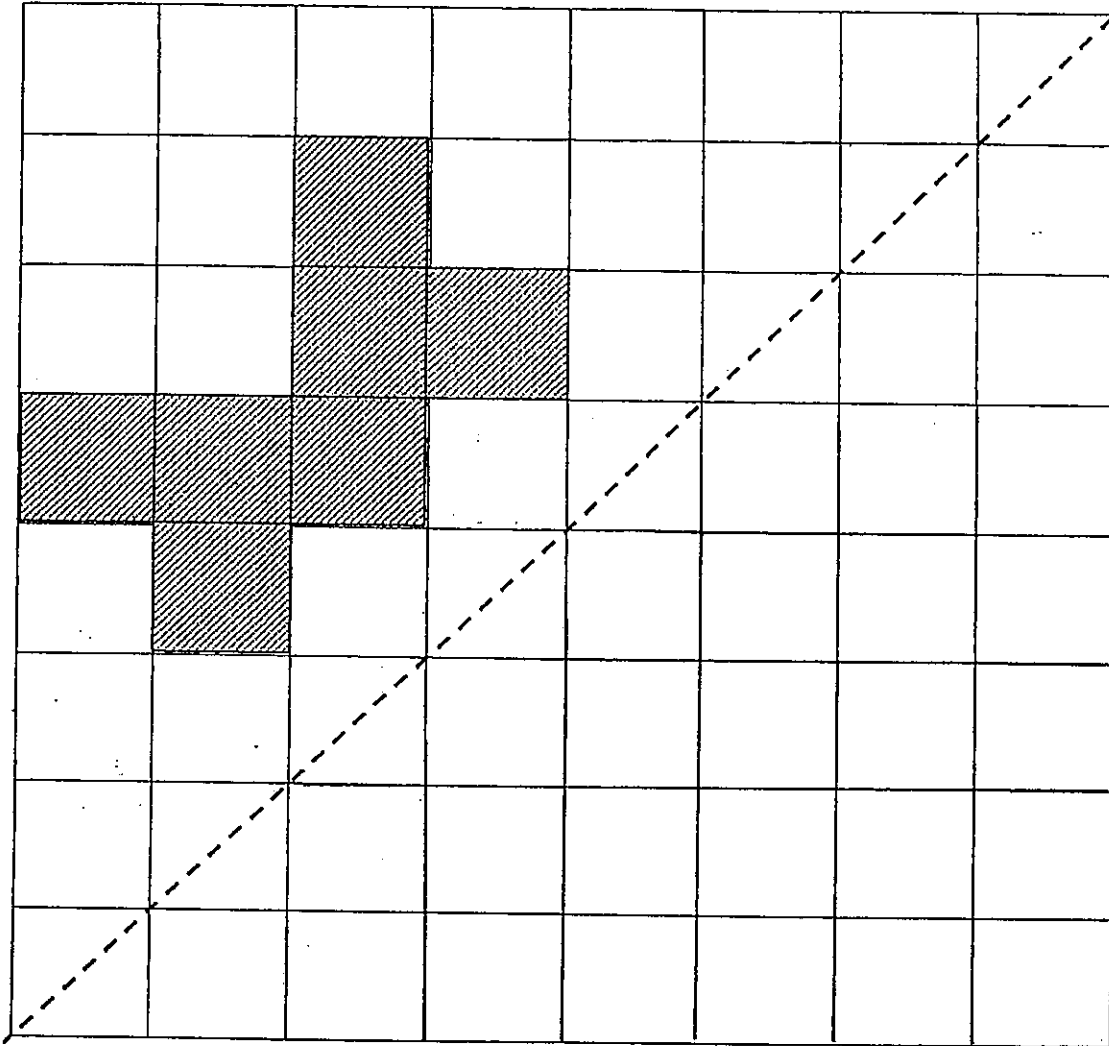

- 33 Figure A shows a paper folded to form a square of side 6 cm. Figure B shows all the flaps opened. Find the area of figure B.

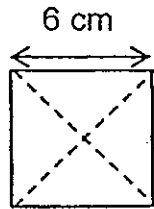

Figure A

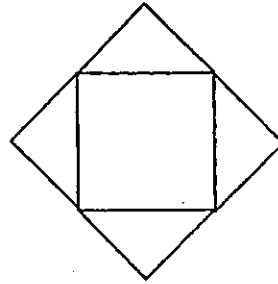
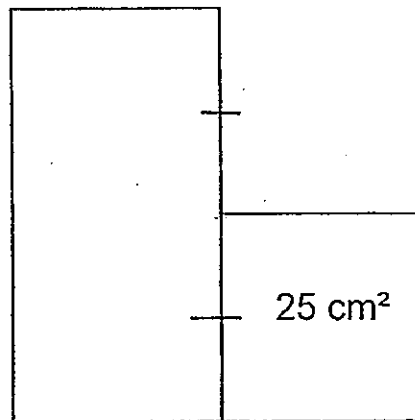

Figure B

Ans: _____ cm^2

- 34 The figure below is made up of a rectangle and a square. The area of the rectangle is twice the area of the square. The area of the square is 25 cm^2 . What is the perimeter of the figure?



Ans: _____ cm

(Go on to the next page)

- 35 A field measures 40 m by 20 m. It has a 3 m wide footpath around it. A fence was built around the footpath as shown in the figure below. What is the perimeter of the fence?

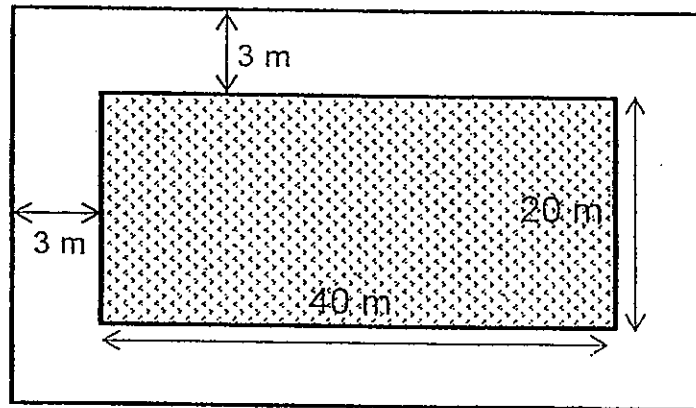

Ans: _____ m

METHODIST GIRLS' SCHOOL (PRIMARY)

Founded in 1887



END-OF-YEAR EXAMINATION 2013 PRIMARY 4 MATHEMATICS BOOKLET C

Total Time: 1 h 45 minutes

INSTRUCTIONS TO CANDIDATES

Do not turn over this page until you are told to do so.
Follow all instructions carefully.
Answer all questions.

Name: _____ ()

Class: Primary 4. _____

Date: 8 OCTOBER 2013

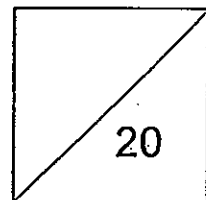

This booklet consists of 6 printed pages including this page.

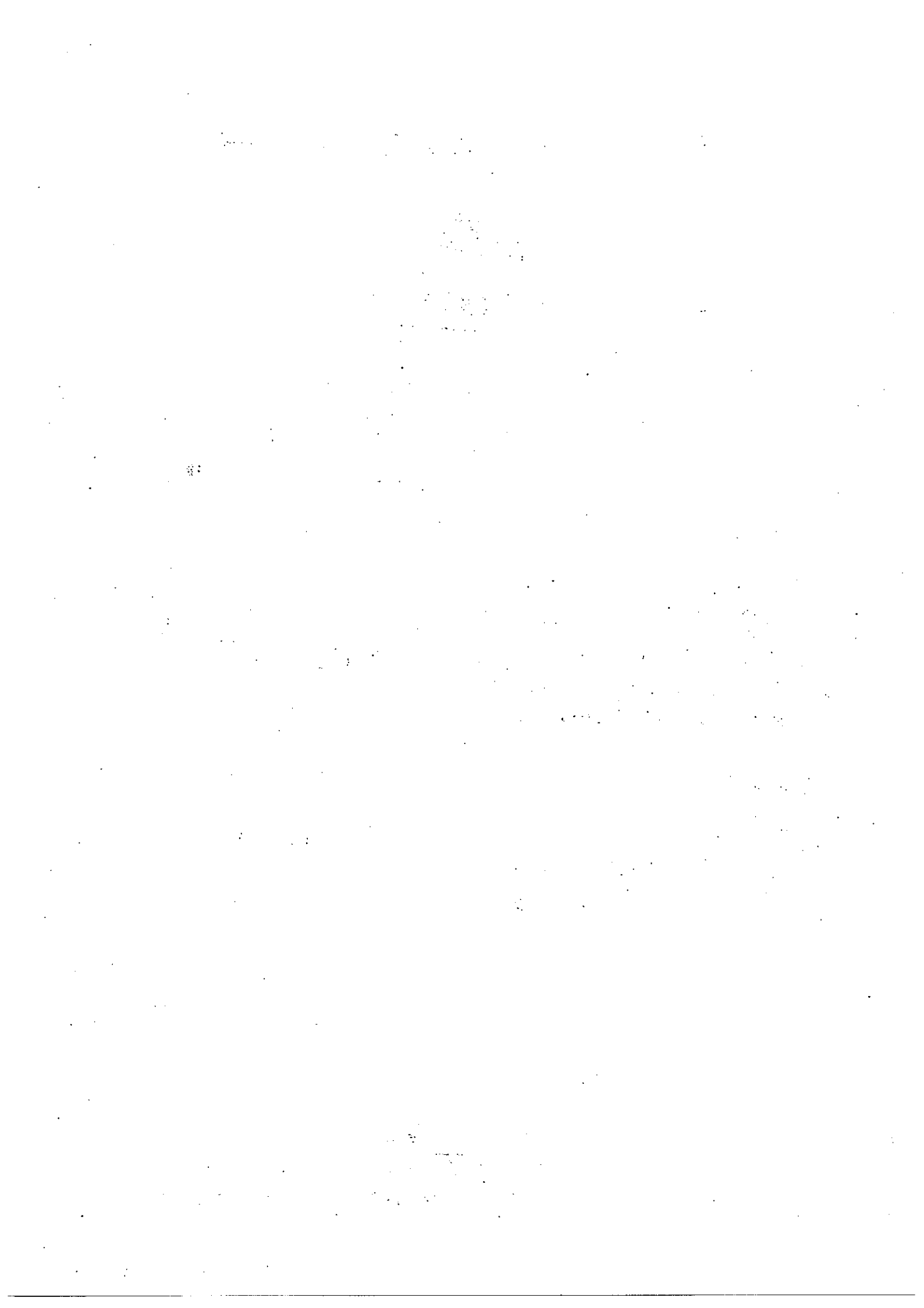

Section C

Questions 36 to 40 carry 4 marks each. Show your working clearly in the space provided for each question and write your answers in the space provided. The number of marks available is shown in brackets [] at the end of each question or part-question. (20 marks)

- 36 At a concert, there were 5 700 adults. There were three times as many adults as children. After all the men left, the number of children became twice the number of women.
- a) How many children were at the concert?
b) How many men left the concert?

Ans: (a) _____ [1m]

(b) _____ [3m]

(Go on to the next page)

37 Mrs Lim had a long piece of ribbon. She used $\frac{2}{9}$ of it to tie a parcel. She used $\frac{1}{3}$ of it for a dress. She had 36 cm left.

- a) What was the length of ribbon she used to tie the parcel with?
- b) What was the length of the ribbon at first?

Ans: (a) _____ [2m]

(b) _____ [2m]

(Go on to the next page)

- 38 Cecilia has twice as many stamps as Devi.
If Cecilia gives Devi 12 stamps, Devi will have 16 stamps fewer than Cecilia.
How many stamps do they have altogether?

Ans: _____ [4m]

(Go on to the next page)

- 39 There were 2.5 kg of biscuits in Container A and Container B.
James took 0.25 kg of biscuits from Container A to share with his friends.
The mass of biscuits in Container A was then 4 times as that in Container B.
What was the mass of biscuits in Container A at first?
Give your answer in kilograms.

Ans: _____ [4m]

(Go on to the next page)

- 40 The figure below shows two identical squares which overlap. The shaded area is one quarter of the area of each square. The area of the shaded part is 16 cm^2 .

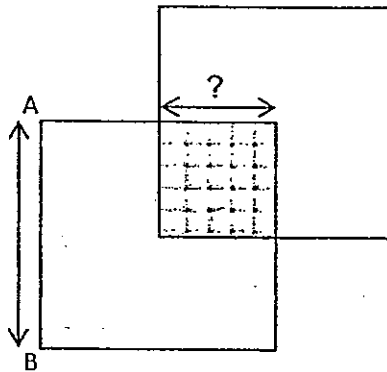

- (a) What is the length of the shaded square?
 (b) What is the length of AB?
 (c) What is the area of the whole figure?

Ans: (a) _____ [1m]

(b) _____ [1m]

(c) _____ [2m]

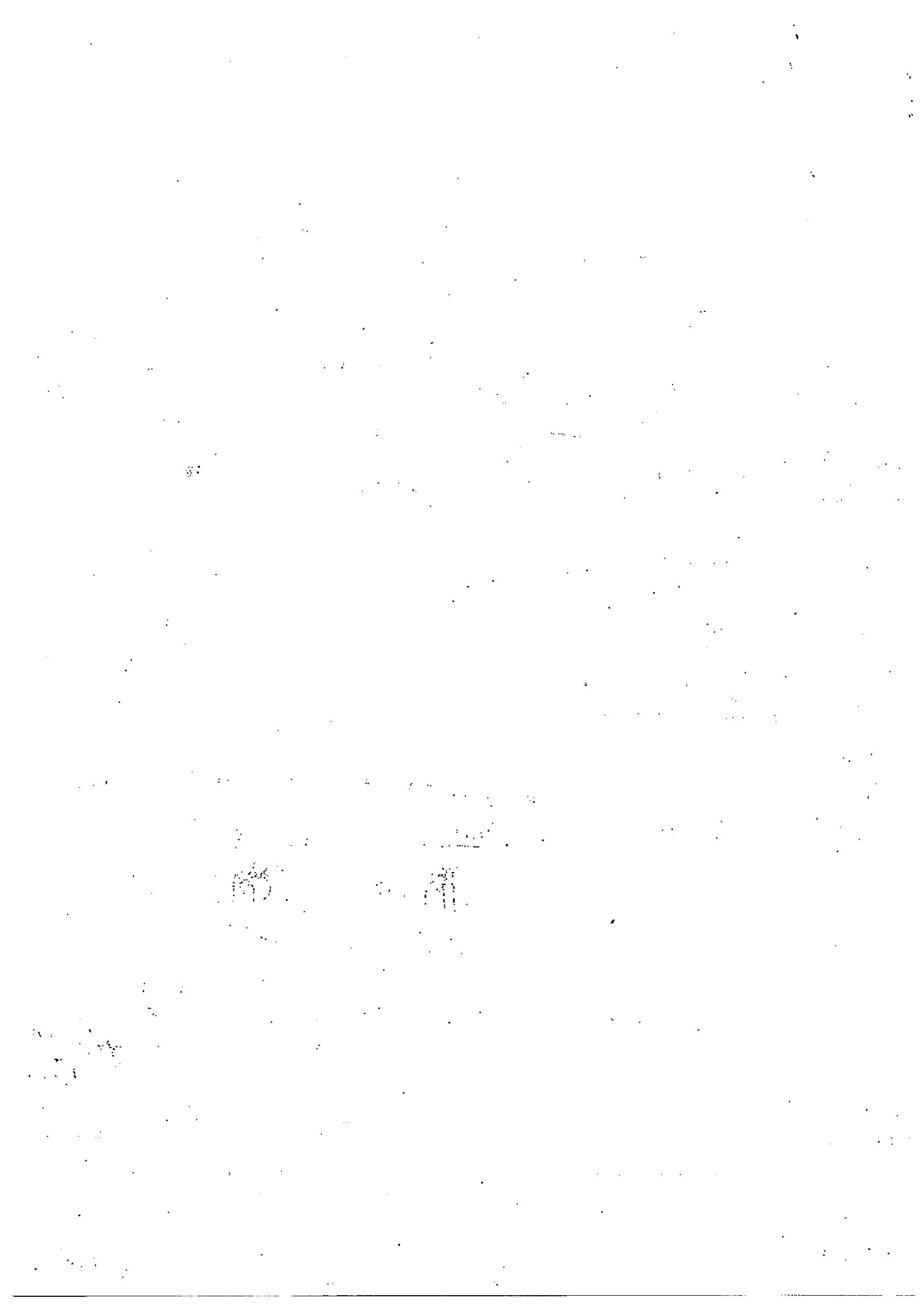

ANSWER SHEET

EXAM PAPER 2013

SCHOOL : METHODIST GIRLS' SCHOOL

SUBJECT : PRIMARY 4 MATHEMATICS

TERM : SA2

Section A

Q1	Q2	Q3	Q4	Q5	Q6	Q7	Q8	Q9	Q10	Q11	Q12	Q13	Q14	Q15	Q16	Q17
2	3	3	2	3	2	2	4	2	1	1	1	3	3	4	3	4

Section B

Q18. 9200

Q19. 9085

Q20. 8 and 12

Q21. $3\frac{1}{2}$

Q22. $\frac{5}{8}$

Q23. 0.045, $\frac{2}{5}$, 0.405

Q24. 0.36

Q25.

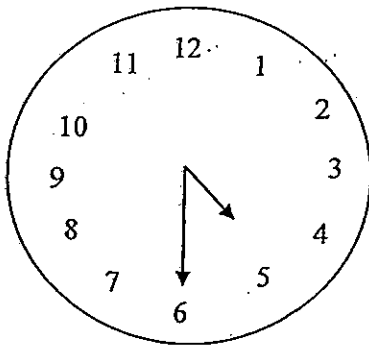

Q26. a) \$12.00

b) \$144.00

Q27. \$10.00

Q28. 1530h

Q29. ED

Q30. 33°

Q31.

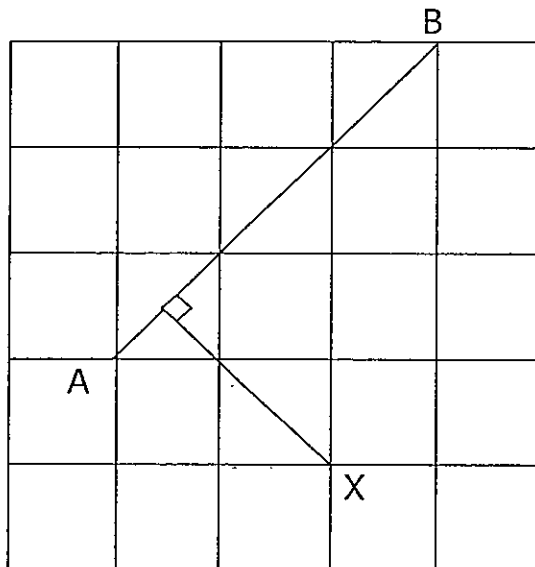

Q32.

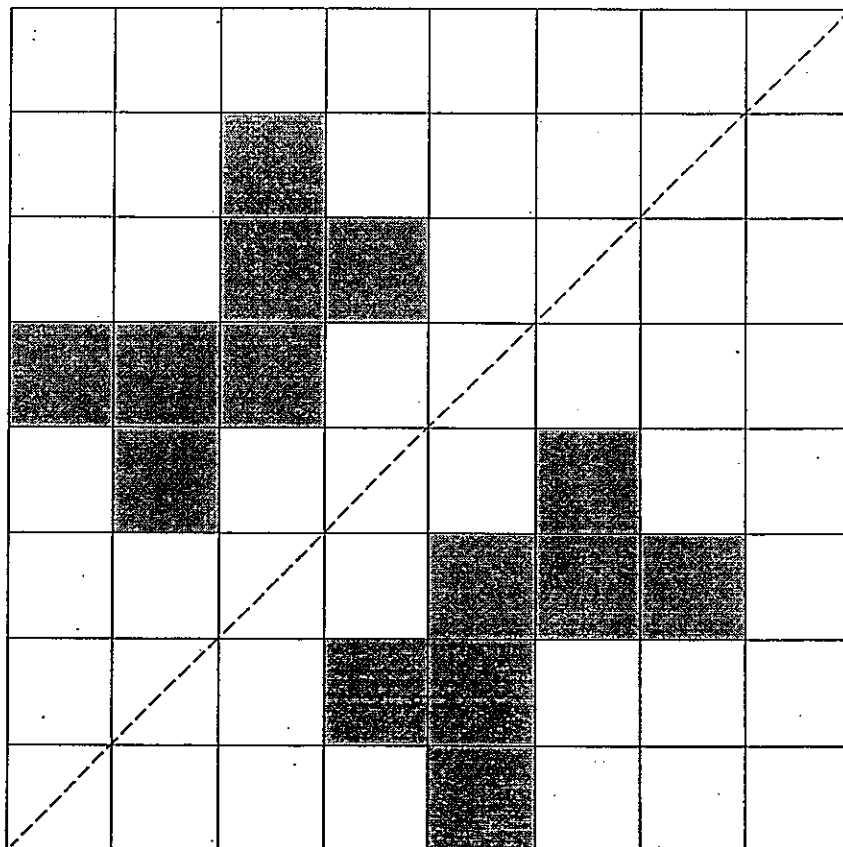

Q33. 72 cm^2

Q34. 40 cm

Q35. 144 m

Section C

Q36. a) 3 units $\rightarrow 5700$

1 unit $\rightarrow 5700 / 3 = 1900$

There were 1900 children at the concert.

b) Women $\rightarrow 1900 / 2 = 950$

Men $\rightarrow 5700 - 950 = 4750$

4750 men left the concert.

Q37. a) 4 units $\rightarrow 36$

1 unit $\rightarrow 36 / 4 = 9$

2 units $\rightarrow 9 \times 2 = 18$

She used 18 cm to tie the parcel.

b) 9 units $\rightarrow 9 \times 9 = 81$

She had 81 cm of the ribbon at first.

Q38. 1 unit $\rightarrow 16 + 12 + 12 = 40$

3 units $\rightarrow 40 \times 3 = 120$

They have 120 stamps altogether.

Q39. $2.5 - 0.5 = 2.25$

5 units $\rightarrow 2.25$

1 unit $\rightarrow 2.25 / 5 = 0.45$

Container A $\rightarrow 4 \text{ units} \rightarrow 0.45 \times 4 = 1.80$

A at first $\rightarrow 1.80 + 0.25 = 2.05$

There was 2.05 kg of biscuits in container A at first.

Q40. a) 4

The length of the shaded square is 4cm.

b) $4 + 4 = 8$

The length of AB is 8cm.

c) Area of square $\rightarrow 8 \times 8 = 64$

Area of 2 squares $\rightarrow 64 + 64 = 128$

Area of whole figure $\rightarrow 128 - 16 = 112$

The area of the whole figure is 112 cm^2 .

