

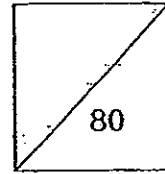

**HENRY PARK PRIMARY SCHOOL
2012 SEMESTRAL EXAMINATION 2
PRIMARY 3 SCIENCE**

Duration of Paper: 1 h 30 min



Name: _____ ()

Parent's Signature

Class: Pr 3: _____

For each question from 1 to 20, four options are given. One of them is the correct answer. Make your choice (1, 2, 3 or 4). Shade the correct oval (1, 2, 3 or 4) on the Optical Answer Sheet.

1. The chart below shows how some living things, A, B, C and D, are observed and compared:

Living Things	Need air, food and water	Can move from one place to another	Have to find food	Is a micro-organism
A	√	√	√	X
B	√	X	X	X
C	√	√	√	X
D	√	√	√	√

(√ - Yes, x - No)

Which one of the following has similar characteristics as a plant?

- (1) A
- (2) B
- (3) C
- (4) D

()



75

2. The table below shows 6 animals classified into 3 groups.

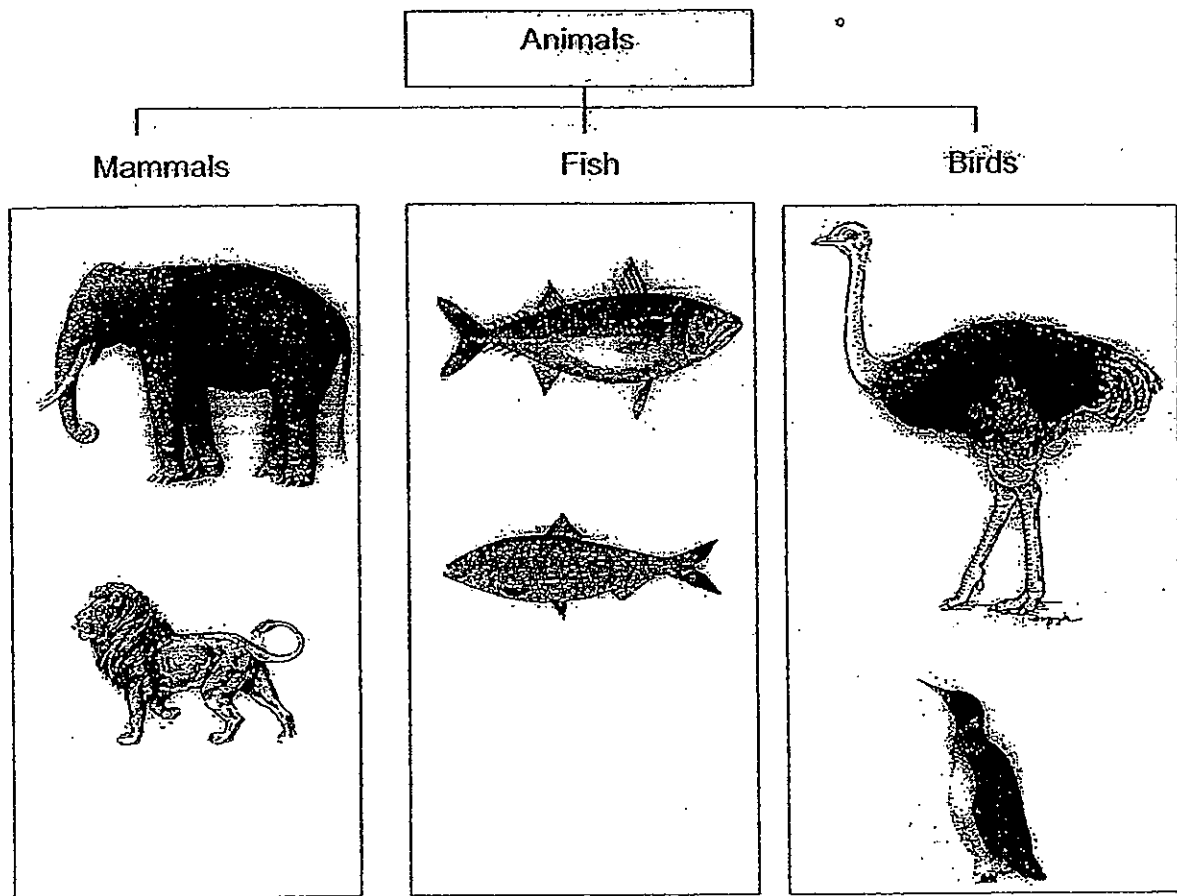

The 6 animals can be kept in the same groups if they are classified according to _____.

- (1) how they reproduce
- (2) their size
- (3) the food they eat
- (4) their outer covering

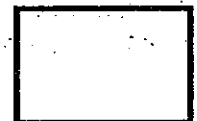

3. Plants, animals and fungi are 3 main groups of living things. The characteristics of fungi and animals are given in the table below.

Groups of Living Things	Examples	Characteristics
Animals	Sheep Snake	They cannot make their own food but can move from place to place
Fungi	Mushroom Bracket Fungi	They cannot make their own food and cannot move from place to place.
Plants	Hibiscus Fern	?

What are the suitable characteristics of plants that are missing from the box above?

- (1) They can make their own food but cannot move from place to place.
- (2) They can make their own food and move from place to place.
- (3) They cannot make their own food and cannot move from place to place.
- (4) They cannot make their own food but can move from place to place. ()



??

The chart below shows the characteristics of living things.

Answer Questions 4 and 5 based on the chart below.

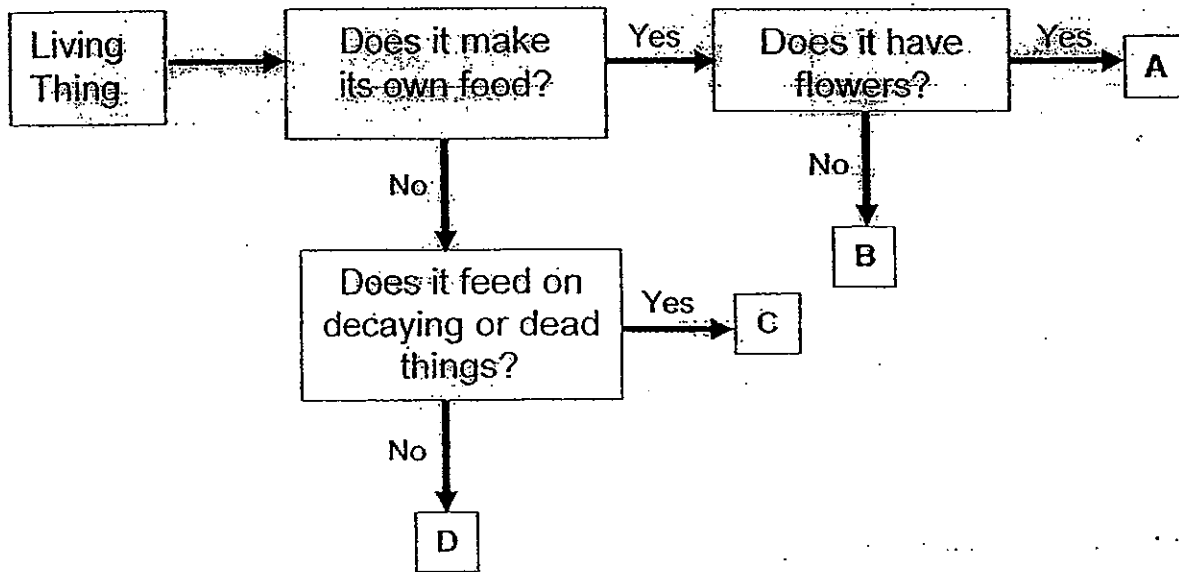

4. Which of the following is Living Thing C most likely to be?

- (1) Lion
- (2) Rose
- (3) Bracket Fungi
- (4) Bird's Nest Fern

5. How are Living Things B and C similar?

- (1) They both make their own food.
- (2) They both cannot make their own food.
- (3) They both have bright coloured flowers.
- (4) They both carry spore bags to reproduce.

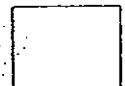

6. Guo Hao carried out an experiment with two ropes made of different materials, A and B, to find out which material is stronger. He suspended the ropes from a height and attached a 15-kg weight to each of them. After 30 minutes, Material A snapped.

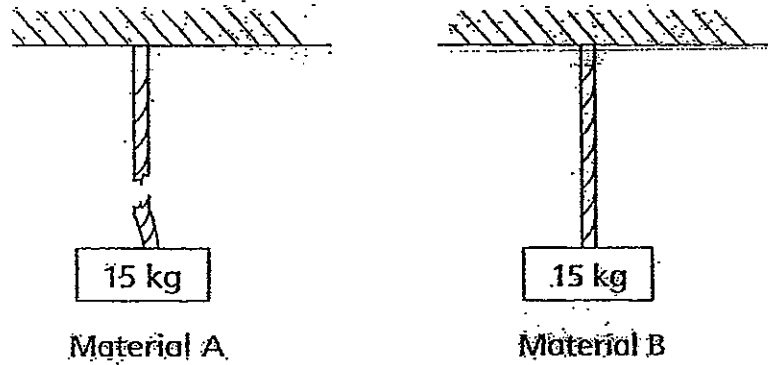

Which variables should he keep the same for a fair experiment?

- A: The colour of the rope
- B: The length of the rope
- C: The material of the rope
- D: The amount of weight attached to the rope

- (1) A only
- (2) A and B only
- (3) B and D only
- (4) C and D only

()

7. Kenji carried out an experiment to test how well each material can absorb water. He used materials T, U, V and W, which are of the same size and thickness. The results of his experiment are shown below.

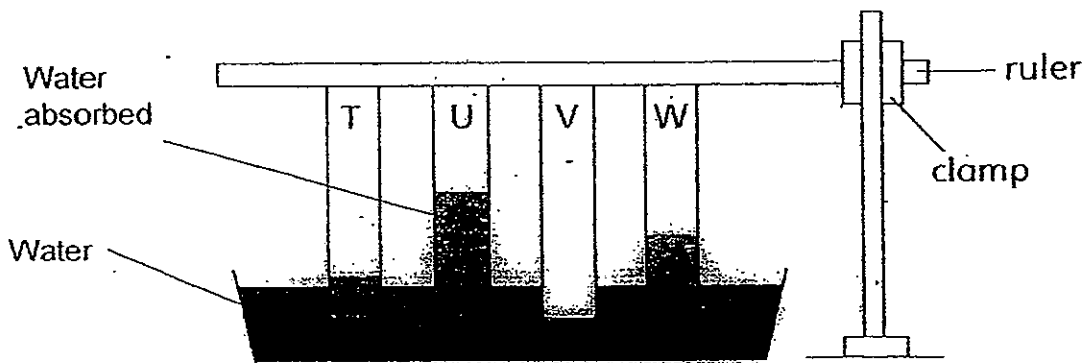

Which material, T, U, V or W, is most suitable for making a bath towel?

- (1) T
- (2) U
- (3) V
- (4) W

()

31
□

8. Tyler is showing his classmates that he can bend a rod.

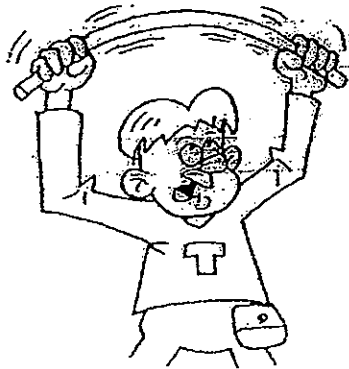

Tyler is able to carry out the above action because the rod is _____.

- (1) light
- (2) hard
- (3) strong
- (4) flexible

()

9. The pictures below show different types of magnets.

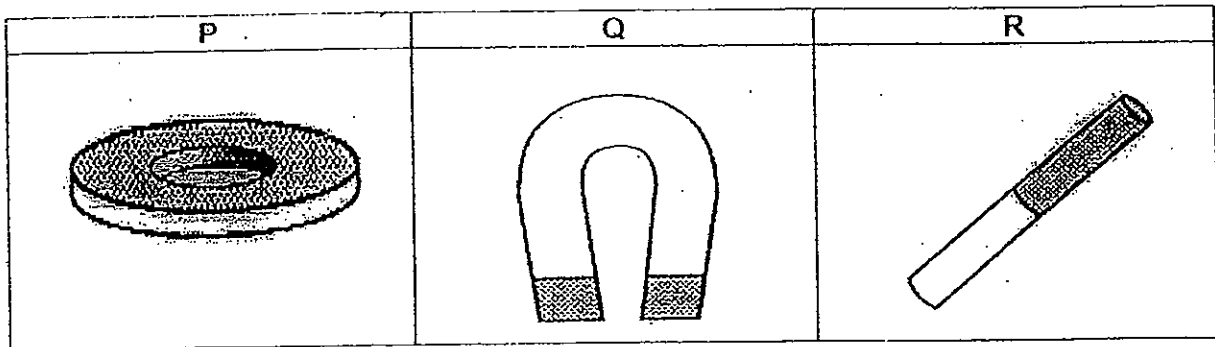

Which of the following is correct?

	P	Q	R
(1)	Ring magnet	U-shaped magnet	Rod magnet
(2)	Button magnet	U-shaped magnet	Bar magnet
(3)	Ring magnet	Horseshoe magnet	Rod magnet
(4)	Button magnet	Horseshoe magnet	Bar magnet

()



10. In the set-up below, E, F, G, H are four rings which pass through a wooden rod. F is a magnet.

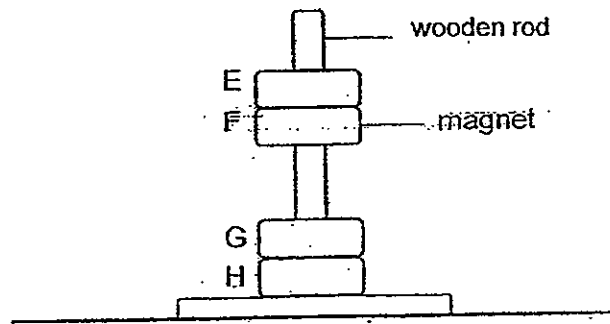

Which of the following correctly represents rings E, G and H?

	E	G	H
(A)	Gold	Magnet	Rubber
(B)	Magnet	Steel	Steel
(C)	Aluminium	Magnet	Steel
(D)	Steel	Steel	Magnet

- (1) A and B only
 (2) A and C only
 (3) B and D only
 (4) C and D only

11. Which of the following shows how a bar magnet will come to rest when suspended freely?

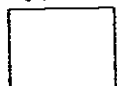
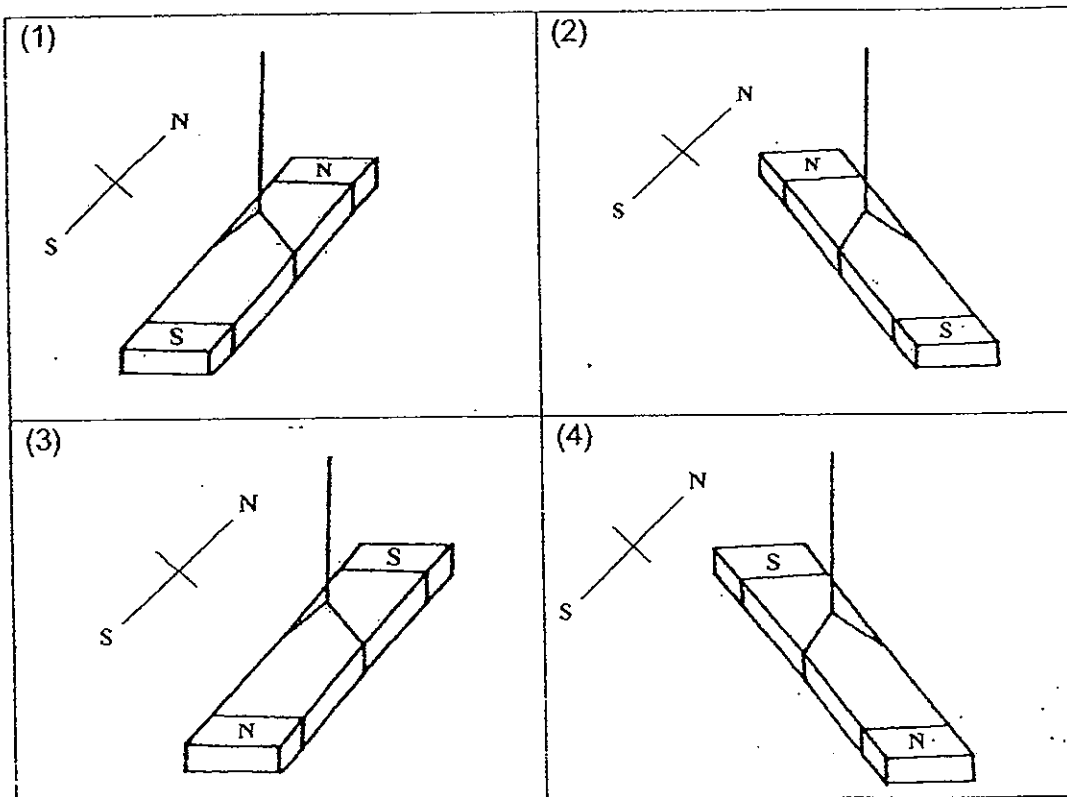

12. The diagram below shows the arrangement of 4 magnets which are attracted at their poles.

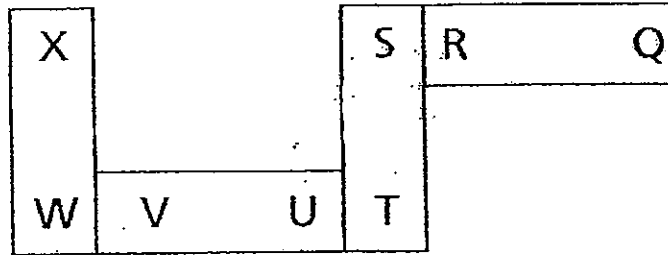

Which of the following are possible arrangements that enable the magnets to attract each other?

(A)

(B)

(C)

(D)

- (1) A and B only
- (2) A and C only
- (3) B and D only
- (4) C and D only

()



13. Which magnetised iron nail in the following set-ups will attract the most number of steel paper clips?

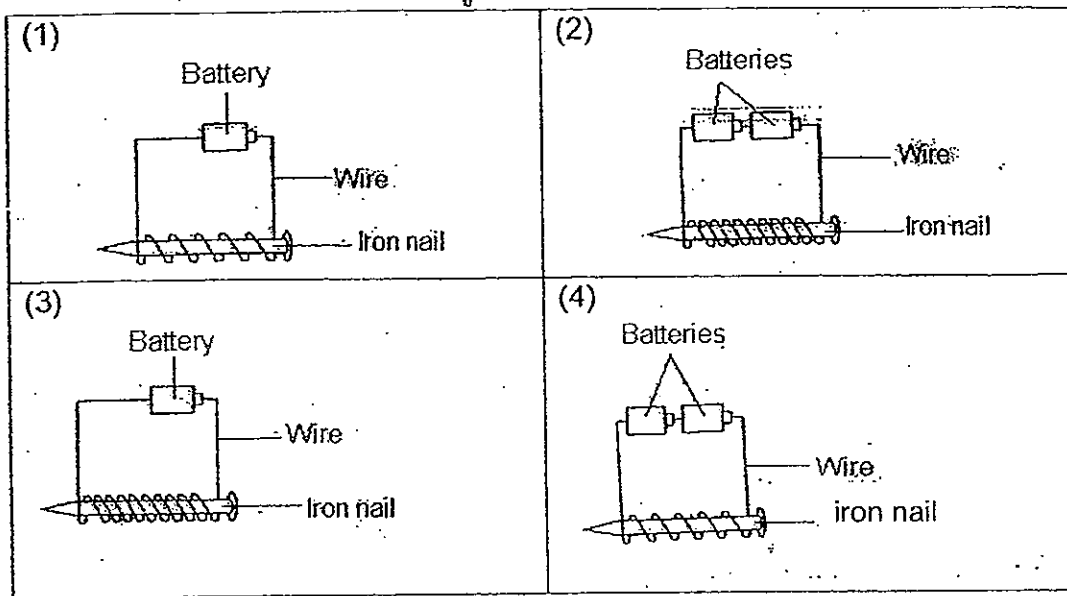

14. Siti attached two bar magnets on top of two cars with their like poles facing each other. She then placed a thick steel sheet between the magnets and the cars moved as shown below.

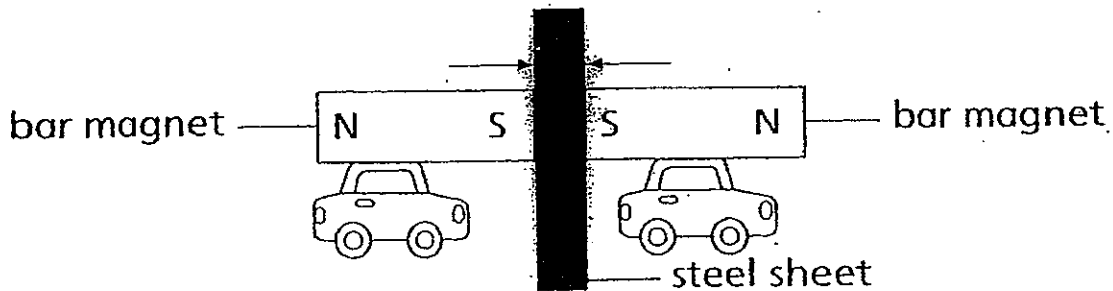

Which of the following explain the movement of the cars?

- (1) The like poles of both magnets attract each other.
- (2) The thick steel sheet is attracted to both magnets.
- (3) Both wheels of the car help to attract both magnets.
- (4) The unlike poles of the thick steel sheet are facing the bar magnets and attracted them.

15. Which of the following DOES NOT make use of magnets to work?

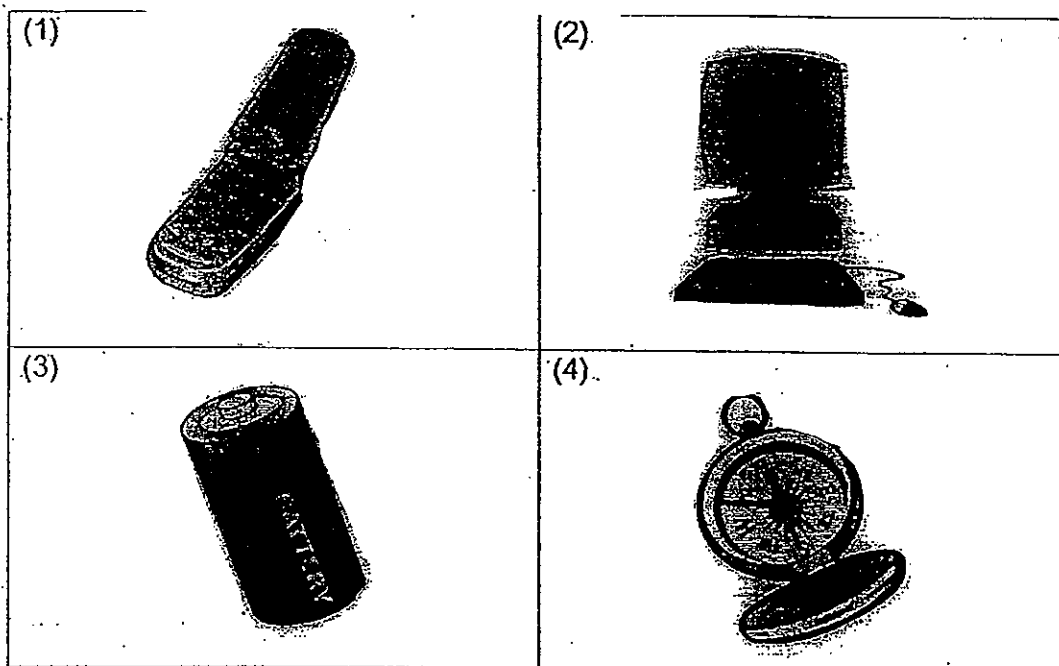

()

16. Which of the following statements are TRUE about the life-cycles of a frog and a chicken?

- A: Both lay eggs in the water.
- B: Both hatch from eggs.
- C: The young of both animals resemble the adult.

- (1) A only
- (2) B only
- (3) A and B only
- (4) B and C only

()

17. Which one of the following animals has a 4 stage-life cycle?

- (1) chicken
- (2) grasshopper
- (3) human
- (4) butterfly

()



18. The graph below shows how long both organism P and organism Q remain in egg stage, larva stage and pupa stage of their life cycles.

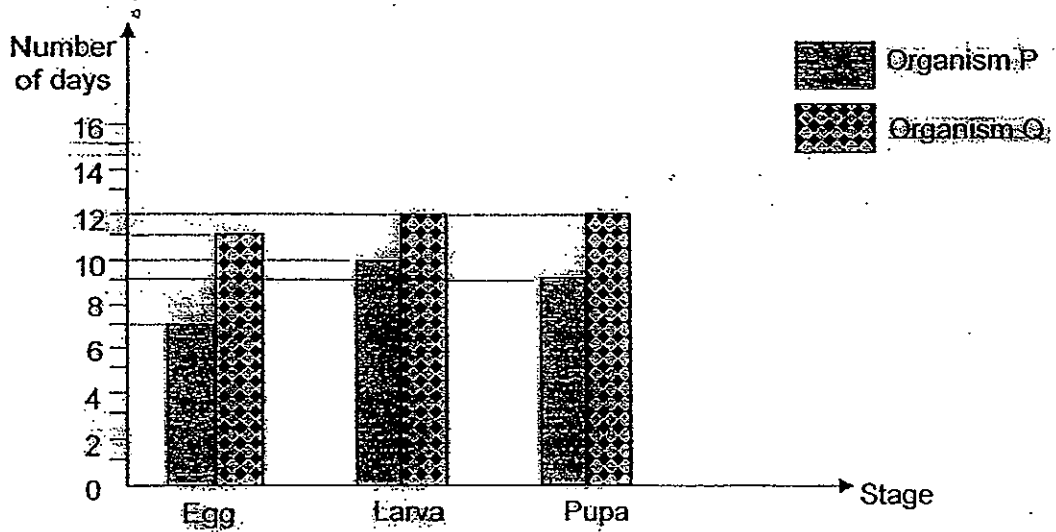

At which one of the following stages would Organism P and Q be on the 20th day after the eggs were laid?

	Stage of lifecycle organism is in on the 20 th day	
	P	Q
(1)	Pupa	Larva
(2)	Larva	Pupa
(3)	Pupa	Pupa
(4)	Larva	Larva

()

19. Which one of the following is NOT needed for a seed to germinate?

- (1) air
- (2) warmth
- (3) water
- (4) sunlight

()

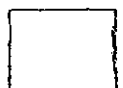

20. Which one of the following shows correctly the life cycle of a plant?

(1)

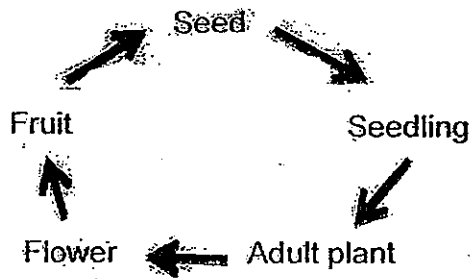

(2)

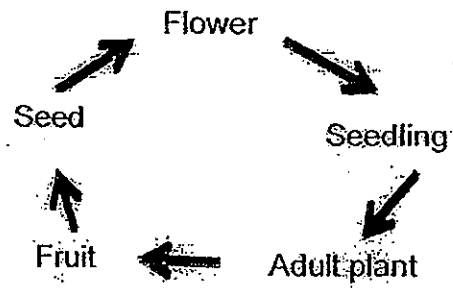

(3)

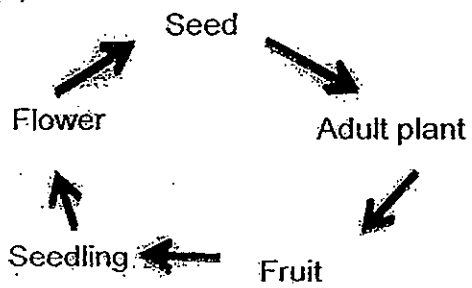

(4)

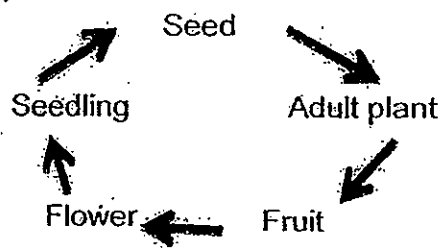

()

End of Section A



Name: _____ () Class: Pr 3 _____

Section B (12 marks)

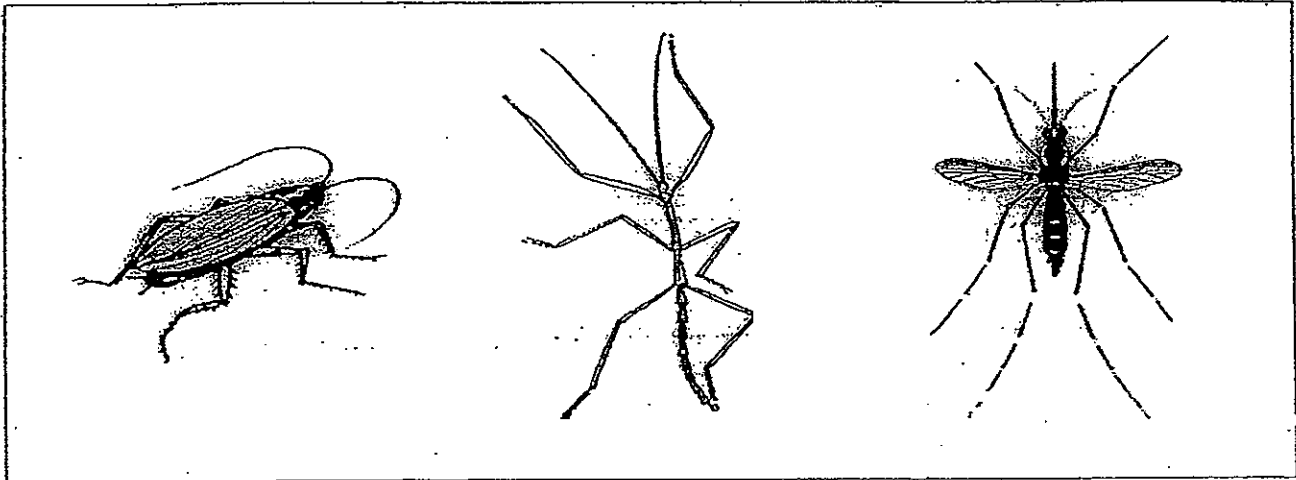

For each question from 21 to 26, read the instructions carefully and write your answer in the spaces provided.

21. Study the 3 animals classified together below.

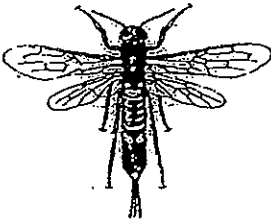
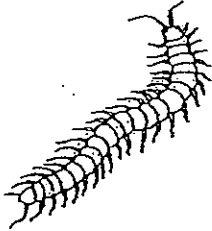

Which of the following animals can be placed in the group shown above? (2m)

Put a tick (✓) in the correct boxes provided below.

22. The chart below shows the properties of Materials A, B, C and D.

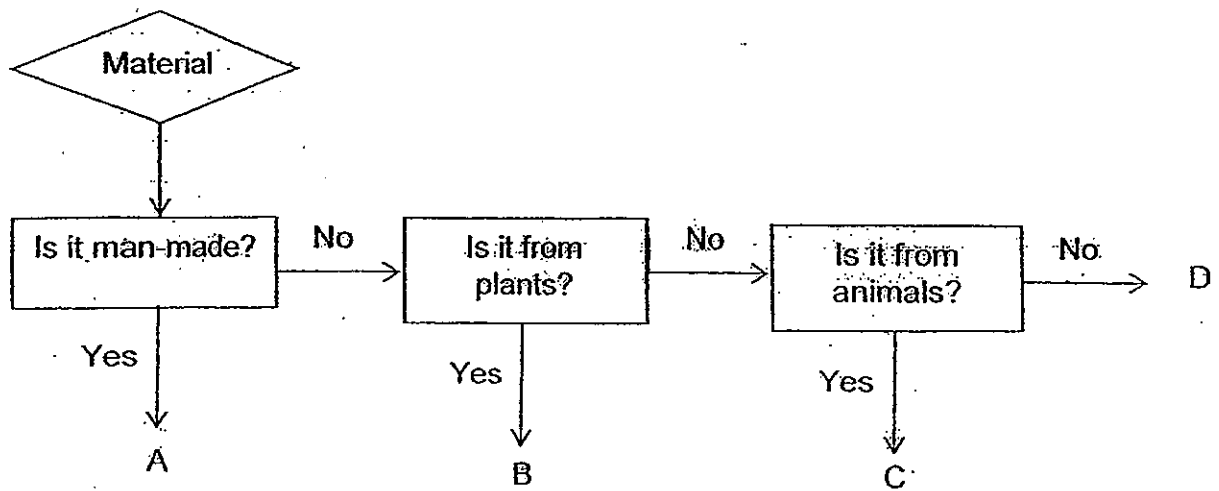

State which of the following materials is A and B.

(2m)

Wood: _____

Plastic: _____

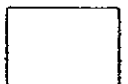

23. Xiaomin carried out an experiment by using different parts of a U-shaped magnet to attract iron pins in a box.

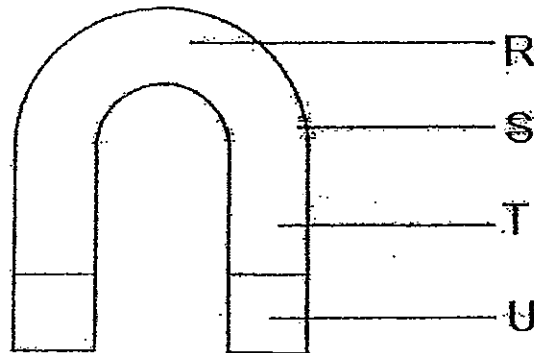

a) Fill in the parts of the magnet, R, S, T and U in the correct boxes in the table below. (1m)

Parts of the magnet				
Number of iron pins attracted	10	20	14	17

b) What was the aim of her experiment? Tick (✓) the correct statement. (1m)

	Statement	Tick
(i)	She wanted to find the poles of the magnet.	
(ii)	She wanted to find out if the magnet is a strong magnet.	
(iii)	She wanted to find out which part of the magnet is the strongest.	
(iv)	She wanted to find out if the iron pins are magnetic materials.	

24. Mei Ling carried out an experiment on 4 objects with a magnet to find out how the objects would respond. She also tested if the objects were waterproof.

Below are her results.

Object	Observations of the object
A	It is not attracted to the magnet.
B	It is repelled by the magnet.
C	It is attracted to the magnet but not repelled by the magnet. It absorbs water.
D	It is attracted to the magnet but not repelled by the magnet. It does not absorb water.

Based on the table above, fill in the boxes below correctly with letters A, B, C and D. (2m)

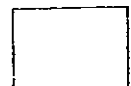
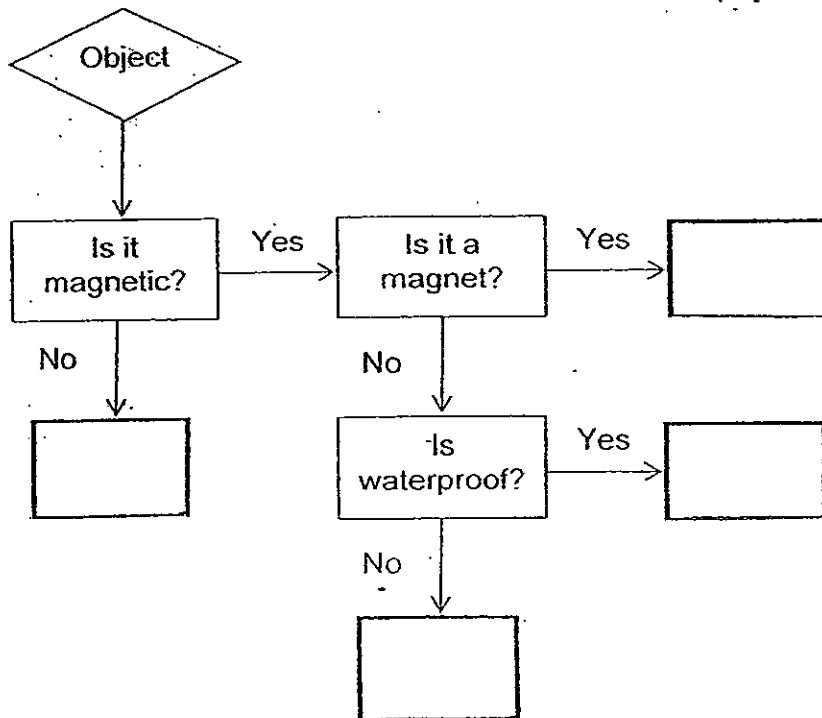

25. The pictures below show the stages in the life cycle of a frog. They are not in correct order.

Write 1, 2, 3 and 4 in the boxes below to put them in correct order, beginning with the adult stage. (2m)

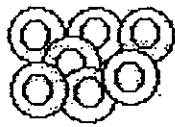

26. Bala and Selva saw a poster at a Science booth in their school. It shows the life cycle of a mosquito.

Name the correct stages in the boxes provided.

(2m)

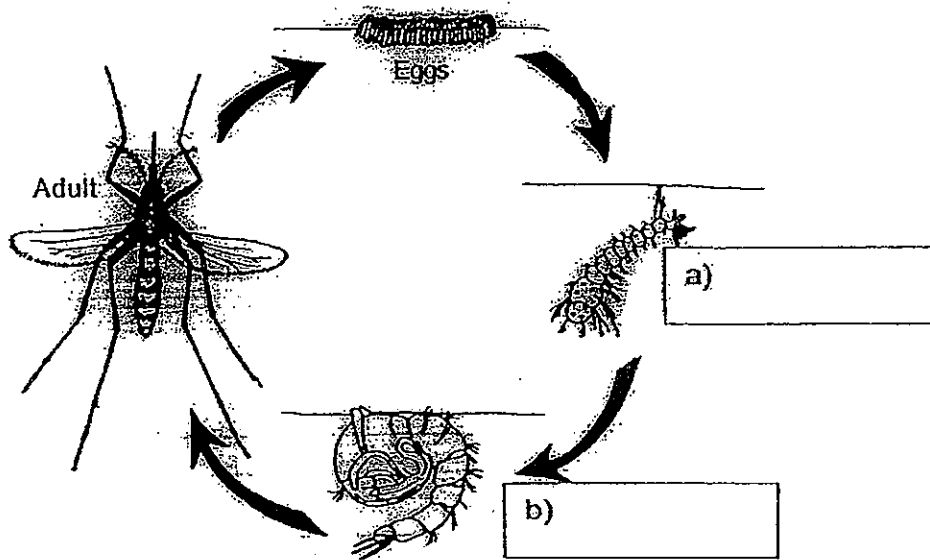

End of Section B

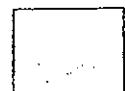

Name: _____ ()

Class: Pr 3 _____

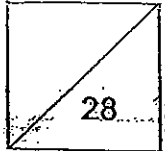

Section C (28 marks)

Write your answers to questions 27 to 34 in the spaces given.

27. Study the following classification chart of some animals.

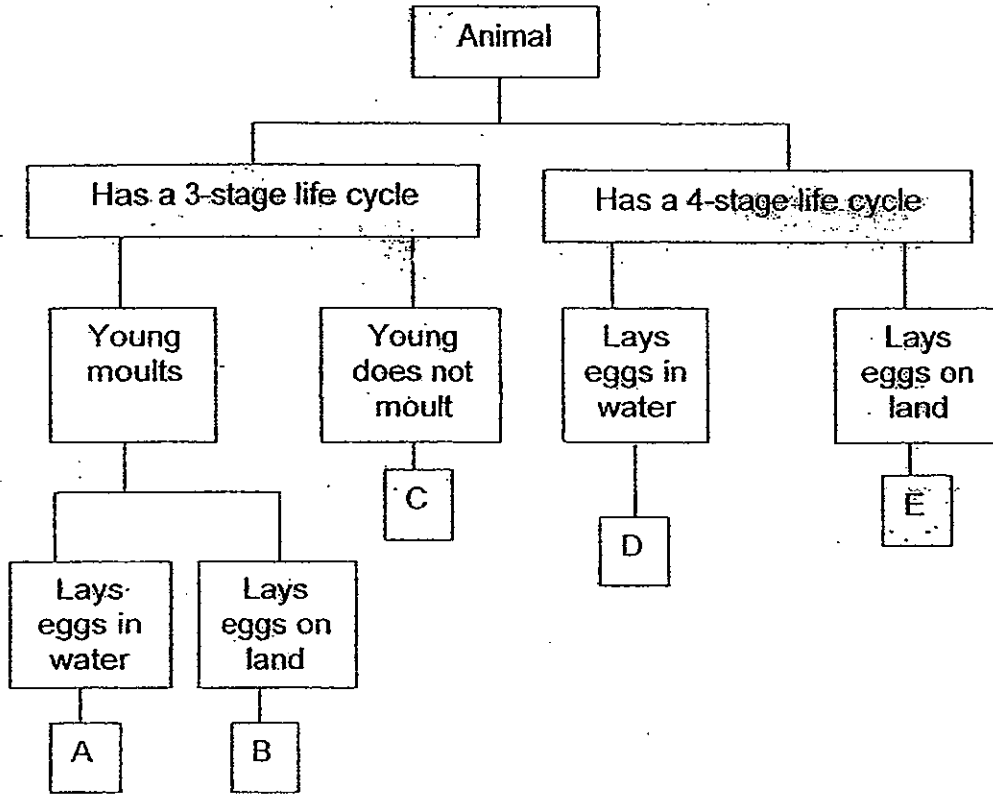

Answer the following questions using only information from the chart above.

(a) State one similarity between Animals A and D. (1m)

(b) State one difference between Animals B and C. (1m)

(c) Which of the above animals, A, B, C, D or E is likely to be (2m)

Butterfly - _____ Mosquito - _____



28. Osman observes organisms X and Y shown below.



Organism X

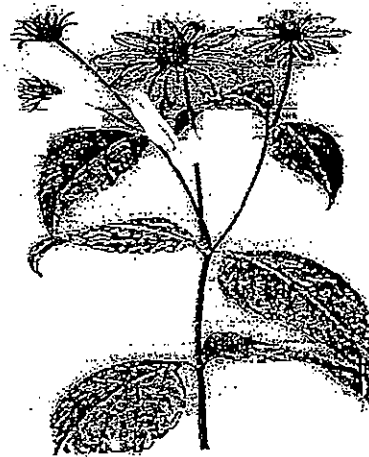

Organism Y

Osman observed how both organisms obtain food and how they reproduce.

He decided not to place Organism X in the same group as Organism Y.

Based on the characteristics of the organisms he has observed, give 2 reasons why Osman decided not to place them in the same group. (4m)

(a)

(b)



29. Nurul carried out an experiment on four different materials, P, Q, R and S of the same thickness.

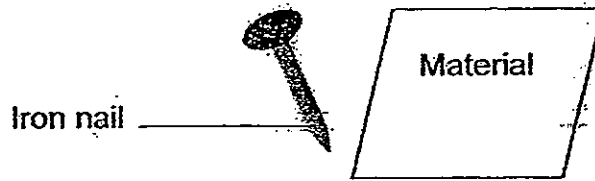

She used an iron nail to scratch each material and she recorded the number of scratches she is able to make on each material. She recorded her results in a bar graph below.

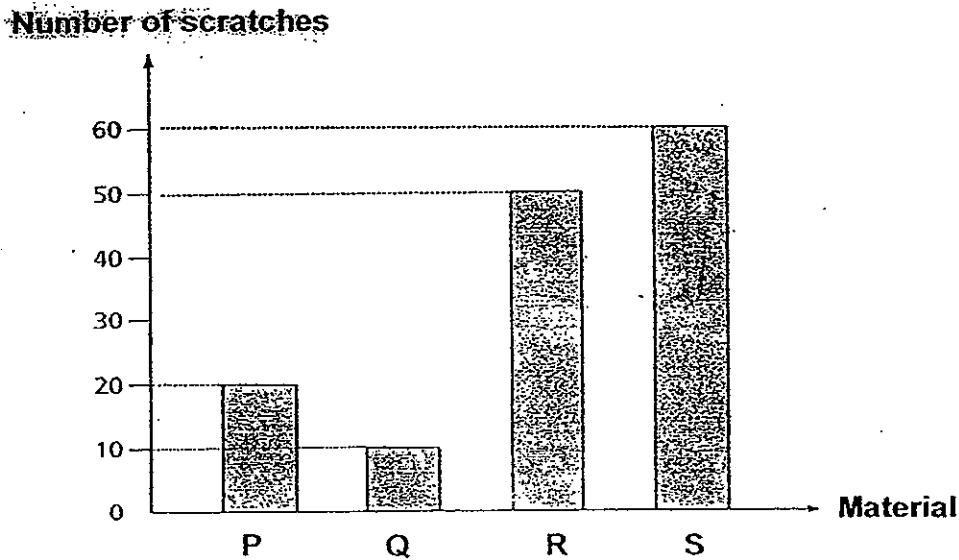

- a) Which property of the materials is Nurul testing? (1m)
-
- b) Flower vases are wrapped with an outer layer when sold to prevent scratches. (1m)
Which material, P, Q, R or S will be most suitable to be used to wrap the flower vases?
-
- c) Using the information from the graph, explain your answer in (b). (1m)
-
- d) Name another variable that must be kept the same in this experiment. (1m)
-



30. Xiaoming carried out an experiment to investigate if Magnet X or Magnet Y was stronger. Below shows his experimental setup.

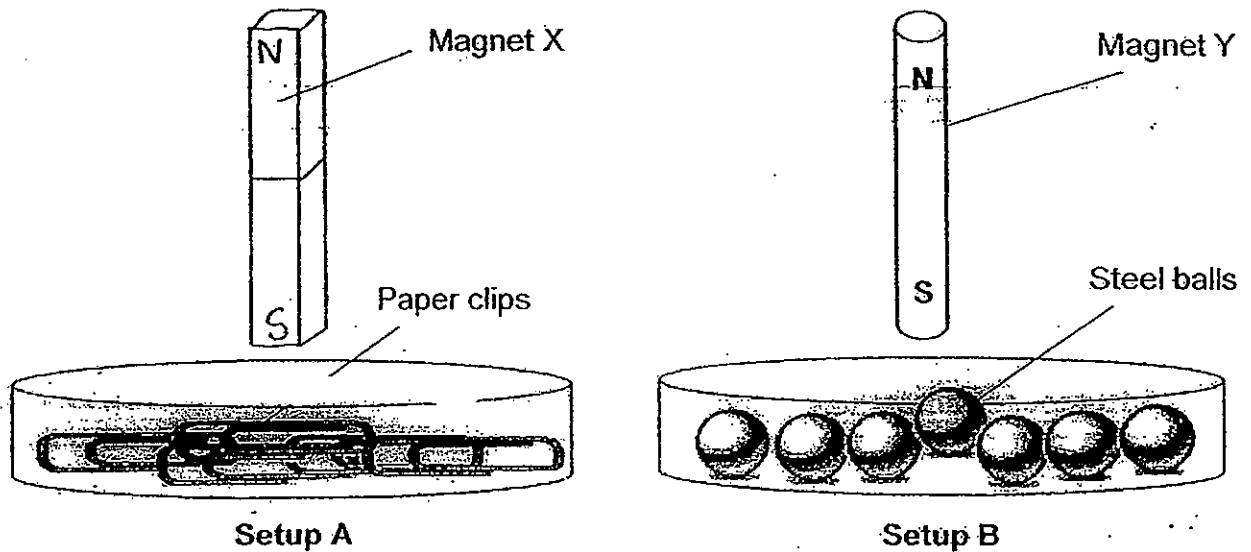

Meiqi said that his experiment is not a fair one.

- a) Explain why Meiqi is correct. (1m)

- b) What should Xiaoming change in his experiment to make it fair? (1m)

- c) Name another variable he has to keep the same for a fair experiment. (1m)



31. Kishan made 2 temporary magnets with 2 similar iron rods X and Y as shown in the diagrams below.

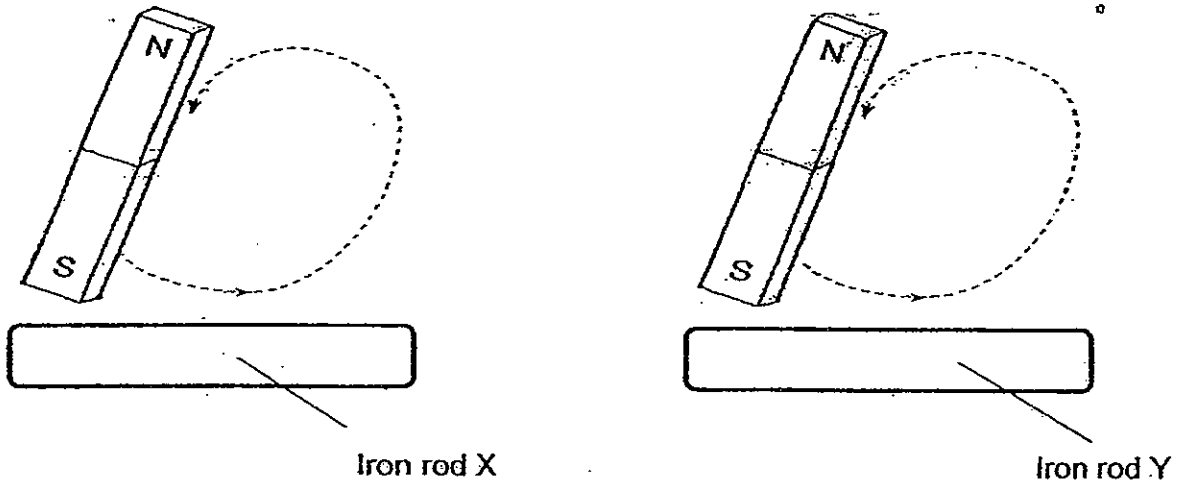

Kishan then recorded the number of paper clips picked up by iron rods X and Y and recorded it in a table below.

Iron rod	Number of paper clips attracted
X	8
Y	12

a) Give 2 reasons to explain why iron rod Y is able to attract more paper clips. (2m)

Reason 1:

Reason 2:

b) Kishan then tried to make a temporary magnet with a wooden rod. (2m)

Is he able to make a temporary magnet? Explain your answer.

32. Kelly carried out an experiment as shown below. She hung a bar magnet above a paper clip which was tied to a weight by a string. The paper clip was then suspended in the air:

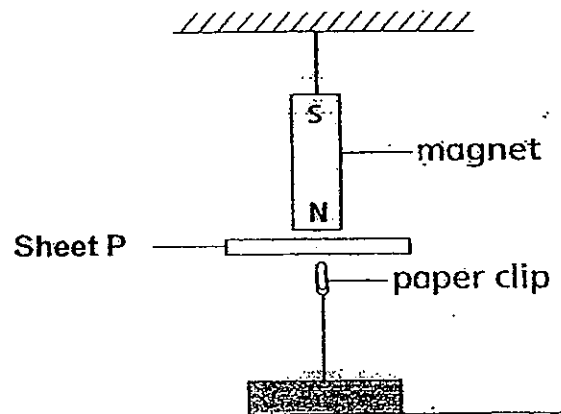

Kelly placed Sheet P in between the paper clip and magnet. She then observed that the paper clip remained suspended in air.

- a) Name one material that Sheet P could be made of. (1m)

- b) Kelly then placed an iron sheet between the magnet and the paper clip. Then Kelly observed the paper clip. What happened to the paper clip? (1m)

- c) Which property of magnets is shown by Kelly's experiment? (1m)

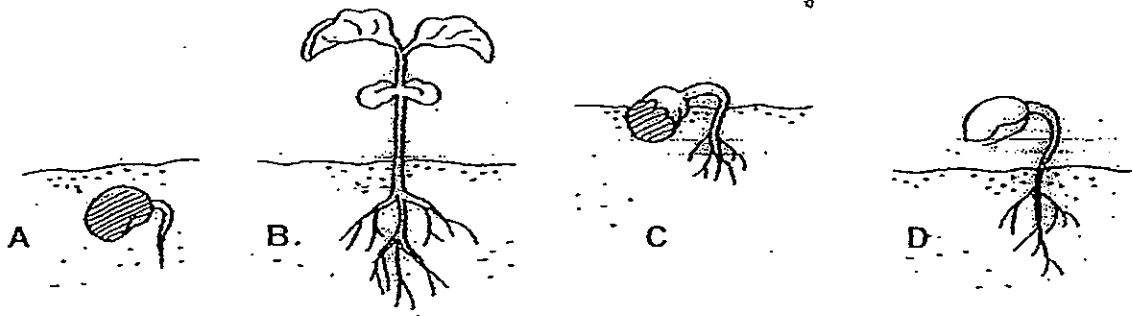

- d) Name 1 variable she has to keep the same for a fair experiment. (1m)

33. The diagram below shows the early stages (A, B, C and D) in the lifecycle of a plant.

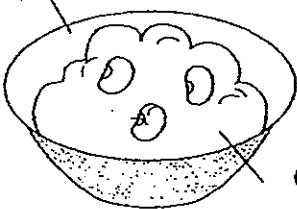

Does the young plant need sunlight to make its own food at stages C and D? (2m)
Give a reason for your answer.

34. Kate wanted to investigate if seeds germinate faster using cotton wool or garden soil.

<p>Bowl A</p>  <p>Cotton Wool</p>	<p>Bowl B</p>  <p>Garden Soil</p>
<p>Placed on the kitchen table</p>	<p>Placed in the garden</p>

Kate watered the seeds everyday. She saw the seeds in Bowl A germinating but not the ones in Bowl B. Kate thought she had carried out a fair experiment.

- a) Did Kate carry out a fair experiment? Explain your answer. (2m)

- b) State 1 other variable she must keep the same for a fair experiment. (1m)

End of Section C

Setters: Mdm Nadia and Mrs Liu Ying Hui

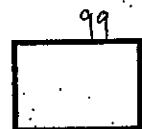

1. The first part of the document discusses the importance of maintaining accurate records of all transactions and activities. It emphasizes that this is crucial for ensuring transparency and accountability in the organization's operations.

2. The second part of the document outlines the various methods and tools used to collect and analyze data. It highlights the need for a systematic approach to data collection and the importance of using reliable sources of information.

3. The third part of the document focuses on the analysis of the collected data. It discusses the various techniques used to identify trends, patterns, and anomalies in the data, and how these insights can be used to inform decision-making and strategic planning.

4. The fourth part of the document discusses the importance of communication and reporting in the data analysis process. It emphasizes the need for clear and concise communication of findings to stakeholders, and the importance of providing actionable recommendations based on the analysis.

5. The fifth part of the document discusses the challenges and limitations of data analysis. It highlights the need for a clear understanding of the data and the importance of being transparent about the limitations of the analysis.

ANSWER SHEET

EXAM PAPER 2012

SCHOOL : HENRY PARK
SUBJECT : PRIMARY 3 SCIENCE

TERM : SA2

Q1	Q2	Q3	Q4	Q5	Q6	Q7	Q8	Q9	Q10	Q11	Q12	Q13	Q14	Q15	Q16	Q17
2	4	1	3	4	3	2	4	3	2	1	1	2	2	3	2	4

Q18	Q19	Q20
1	4	1

21)

✓		✓	
---	--	---	--

22) Wood : Material B Plastic : Material A

23)a) R U S T
b) iii

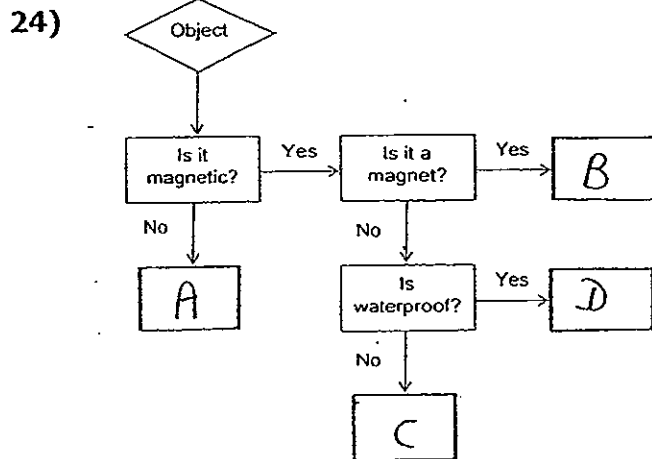

25)3 2 1 4

26)a)larva b)pupa

27)a)Both animals' adult egg in water.

b)Animal B's young moults while Animal C's young does not.

c)Butterfly - Animal E Mosquito - Animal D

28)a)Organism Y reproduces by seeds while organism X reproduces by spores.

b)Organism can make its own food while Organism X feeds on decaying matter.

29)a)The property of hardness.

b)Material Q.

c)The graph stated that Material Q had the least number of scratch mark, thus, it is the hardest material.

d)The size of material scratched.

30)a)He has steel balls and paper-clips for both setups.

b)Xiaoming should replace the steel balls with paper clips.

c)Size of the container.

31)a)1)Iron rod Y could have been stroked more times than Iron rod X.

2)Iron rod Y could have been placed nearer to the paper clips than Iron rod X.

b)No. Woos is not a magnetic material.

32)a)Sheet P could be made out of copper.

b)The paper clip did not stay suspended in the the air-it dropped.

c)Magnetism can pass through non-magnetic materials but not magnetic materials.

d)Thickness of the sheets used.

33)No. In stages C and D, the seedling feeds on its seed leaf.

34)a)No. The bowls were not placed the same place.

b)The size of the bowls where the seeds are placed.