

Name:	Index Number:	Class:
-------	---------------	--------



HUA YI SECONDARY SCHOOL

**4E/5N**

Preliminary Examination 2022

**4E/5N****MATHEMATICS****4048/1**

Paper 1

26 August 2022

2 hours

Candidates answer on the Question Paper.

**READ THESE INSTRUCTIONS FIRST**

Write your Name, Class and Index Number in the spaces provided at the top of this page.

Write in dark blue or black pen.

You may use an HB pencil for any diagrams or graphs.

Do not use staples, paper clips, glue or correction fluid.

Answer **all** questions.

If working is needed for any question it must be shown in the space below with the answer.

Omission of essential working will result in loss of marks.

The use of an approved scientific calculator is expected, where appropriate.

If the degree of accuracy is not specified in the question, and if the answer is not exact, give the answer to three significant figures. Give answers in degrees to one decimal place.

For  $\pi$ , use either your calculator value or 3.142, unless the question requires the answer in terms of  $\pi$ .

The number of marks is given in brackets [ ] at the end of each question or part question.

The total of the marks for this paper is 80.

<b>For Examiner's Use</b>
<b>80</b>

This document consists of **17** printed pages including the cover page.

© HYSS 2022

No part of this document may be reproduced in any form or transmitted in any form or by any means without the prior permission of Hua Yi Secondary School.

**[Turn Over**

Setter: Ms Lee Hui Ling

**Mathematical Formulae****Compound interest**

$$\text{Total amount} = P \left( 1 + \frac{r}{100} \right)^n$$

**Mensuration**

$$\text{Curved surface area of a cone} = \pi r l$$

$$\text{Surface area of a sphere} = 4\pi r^2$$

$$\text{Volume of a cone} = \frac{1}{3} \pi r^2 h$$

$$\text{Volume of a sphere} = \frac{4}{3} \pi r^3$$

$$\text{Area of triangle } ABC = \frac{1}{2} ab \sin C$$

$$\text{Arc length} = r\theta, \text{ where } \theta \text{ is in radians}$$

$$\text{Sector area} = \frac{1}{2} r^2 \theta, \text{ where } \theta \text{ is in radians}$$

**Trigonometry**

$$\frac{a}{\sin A} = \frac{b}{\sin B} = \frac{c}{\sin C}$$

$$a^2 = b^2 + c^2 - 2bc \cos A$$

**Statistics**

$$\text{Mean} = \frac{\sum fx}{\sum f}$$

$$\text{Standard deviation} = \sqrt{\frac{\sum fx^2}{\sum f} - \left( \frac{\sum fx}{\sum f} \right)^2}$$

1. Given that  $2^{1003} + 2^{1000} = 2^m \times 3^n$ , find the value of  $m$  and of  $n$ .

*Ans:*  $m =$  \_\_\_\_\_,

$n =$  \_\_\_\_\_ [3]

2. The first four terms of a sequence are 27, 24, 21 and 18.

(a) Write down the 8<sup>th</sup> term of the sequence.

*Ans:* \_\_\_\_\_ [1]

(b) Find an expression, in terms of  $n$ , for the  $n^{\text{th}}$  term of the sequence.

*Ans:* \_\_\_\_\_ [1]

(c) Will  $-31$  be a term in the sequence? Explain.

*Answer*

.....

..... [1]

3. In the diagram,  $AB = DC$  and  $AC = DB$ . The line  $BD$  intersect the line  $AC$  at  $T$ .

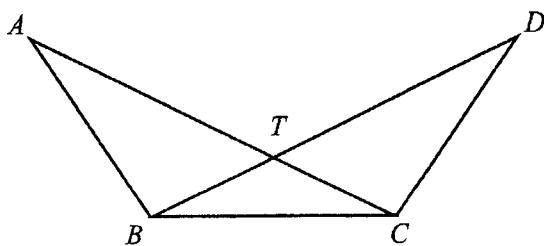

- (a) Prove that  $\triangle ABC$  is congruent to  $\triangle DCB$ .

*Answer*

*Ans:* \_\_\_\_\_ [2]

- (b) Explain why  $\triangle TBC$  is an isosceles triangle.

*Answer*

.....

.....

[1]

4. Written as a product of its prime factors,  $p = 3^3 \times 5 \times 7^2$ .

(a) Express 450 as a product of its prime factors.

*Ans:* \_\_\_\_\_ [1]

(b) Find the highest common factor of  $p$  and 450.

*Ans:* \_\_\_\_\_ [1]

(b) Find the smallest integer  $m$  such that  $450m$  is a multiple of  $p$ .

*Ans: m =* \_\_\_\_\_ [1]

(c) Find the value of  $a$  and  $b$  such that  $p \times \frac{a}{b}$  is a perfect cube where  $a$  and  $b$  are prime numbers.

*Ans: a =* \_\_\_\_\_

*b =* \_\_\_\_\_ [2]

5. The point  $\left(\frac{1}{2}, \frac{1}{2}\right)$  is shown on the axes. Sketch the graph of  $y = 2x^3$ .

[2]

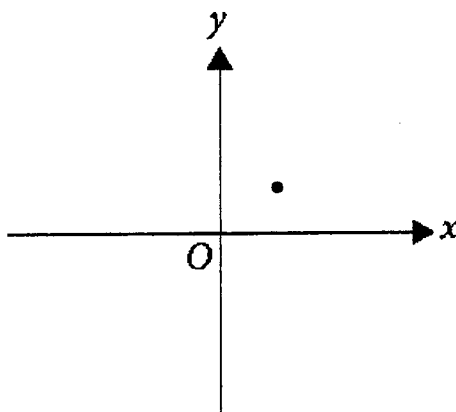

- 
6. Given that  $\left(\frac{1}{7}\right)^{3y} = 7^{\frac{3}{5}}$ , find the value of  $y$ .

*Ans:*  $y =$  \_\_\_\_\_ [2]

- 
7. Simplify  $\left(\frac{2p^3}{5q}\right)^{-2} \times \frac{4}{p^{-7}q}$ , leaving your answer in positive indices.

*Ans:* \_\_\_\_\_ [2]

8. Write an inequality to represent the range of values of  $x$  shown on the number line below.

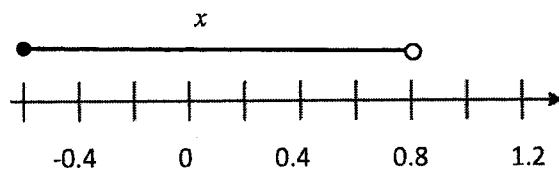

*Ans:* \_\_\_\_\_ [1]

9. Solve the inequality  $\frac{4x+3}{-2} \leq 5$ .

*Ans:* \_\_\_\_\_ [2]

10. Given that  $3v = \sqrt{25 - x^2}$ ,  
 (a) find the value of  $v$  when  $x = -3$ ,

*Ans:* \_\_\_\_\_ [1]

- (b) make  $x$  the subject of  $3v = \sqrt{25 - x^2}$ .

*Ans:* \_\_\_\_\_ [3]

11. Show that  $(3n + 1)^2 + 2$  is always divisible by 3 for all integer values of  $n$ .

[2]

*Answer*

- 
12. The probabilities of Andrew, Ben and Caleb passing the driving test are  $\frac{3}{5}$ ,  $\frac{2}{3}$  and  $\frac{3}{4}$  respectively.

- (a) Find the probability that only Andrew passes the driving test.

*Ans:* \_\_\_\_\_ [1]

- (b) Find the probability that at least one of them passes the driving test.

*Ans:* \_\_\_\_\_ [2]



13. The diagram shows triangle  $ABD$  and  $BCD$  is a straight line.  
It is also known that  $AB = 7$  cm,  $BC = 5$  cm and angle  $BAC =$  angle  $ADC$ .

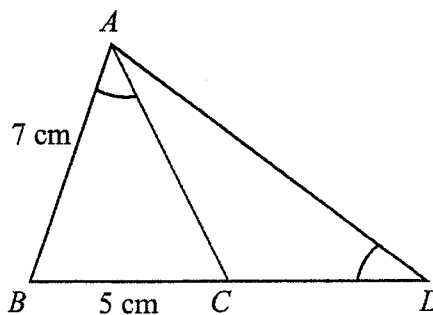

- (a) Prove that triangle  $ABC$  is similar to triangle  $DBA$ .

[2]

*Answer*

- (b) Find the length of  $CD$ .

*Ans:* \_\_\_\_\_ cm [2]

14. Two empty paper cups are geometrically similar.  
The thickness of the paper used is negligible.  
The big cup can be filled by 8 small cups.  
The height of the smaller cup is 5 cm and the base area of the big cup is  $26 \text{ cm}^2$ .

(a) Find the height of the big cup.

*Ans:* \_\_\_\_\_ cm [2]

(b) Find the base area of the small cup.

*Ans:* \_\_\_\_\_  $\text{cm}^2$  [1]

(c) Julie said that the mass of one big cup is 8 times that of the small cups. Do you agree? Explain.

*Answer*

[1]

.....  
.....

15. The diagram shows a hexagon. Three interior angles are as shown. The remaining three interior angles are equal. Find  $x$ .

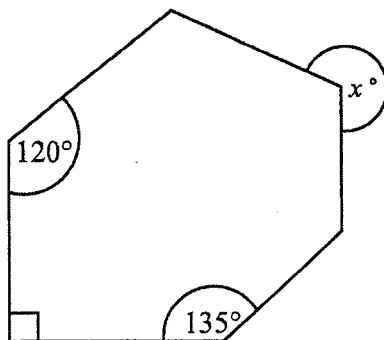

Ans  $x =$  \_\_\_\_\_  $^\circ$  [3]

16. In the diagram,  $BP$  is parallel to  $CQ$ .  $AB = AC = CD$ ,  $\angle ABP = 19^\circ$  and  $\angle QCD = 68^\circ$ . Calculate  $\angle CDA$ . Show workings clearly and give reasons for your workings.

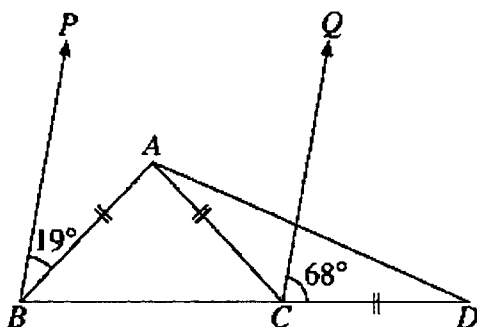

Ans: \_\_\_\_\_  $^\circ$  [3]

17. Aladdin invested \$20 000 in a savings account which pays compound interest at the rate of  $r$  % per year. The interest is compounded quarterly. The formula below shows the total amount of the investment at the end of  $n$  years.

$$\text{Total amount} = 20\,000 \left(1 + \frac{r}{1000}\right)^{20}$$

Find the value of  $r$  and  $n$ .

*Ans:*  $r =$  \_\_\_\_\_

$n =$  \_\_\_\_\_ [2]

18. (a) Sketch the graph of  $y = 5 - (x - 2)^2$ , showing clearly the turning point and the  $y$ -intercept. [2]

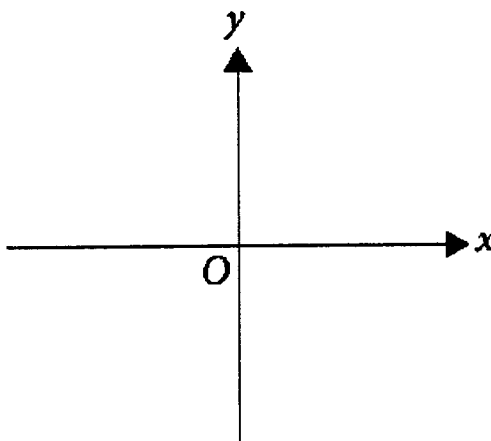

- (b) Using your graph, explain why  $5 - (x - 2)^2 = 7$  will not have a solution.

*Answer*

.....

..... [1]

19. (a) Factorise  $27x^2 - 12$  completely.

*Ans:* \_\_\_\_\_ [2]

(b) Hence, simplify  $\frac{5}{27x^2 - 12} + \frac{2}{2 - 3x}$ .

*Ans:* \_\_\_\_\_ [3]

---

20. A fraction is such that its denominator is 3 more than its numerator. When 1 is added to both the numerator and denominator, the result is  $\frac{7}{8}$ . Find the original fraction.

*Ans:* \_\_\_\_\_ [3]

21.  $PQR$  is a triangle.  $\overrightarrow{PQ} = \begin{pmatrix} 2 \\ -3 \end{pmatrix}$ ,  $\overrightarrow{PR} = \begin{pmatrix} -3 \\ 9 \end{pmatrix}$  and  $Q$  is the point  $(0, 5)$ .

(a) Find the coordinates of  $P$ .

Ans:  $P$  (\_\_\_\_\_, \_\_\_\_\_) [1]

(b) Calculate the length of  $QR$ .

Ans: \_\_\_\_\_ units [2]

22.

$\xi = \{x: x \text{ is a positive integer and } x < 10\}$

$A = \{2, 3, 5, 7\}$

$B = \{1, 4, 9\}$

$C = \{2, 4, 7\}$

(a) Circle the correct statements from the list below. [2]

$\{7\} \in C$        $B \cup C = \{4\}$        $\{9\} \subset B$        $A \cap B = \{\phi\}$        $5 \notin A'$

(b) Find  $A' \cap C$ .

Ans: \_\_\_\_\_ [1]

(c) Describe in words, the elements in set  $B$ .

Answer [1]

.....  
 .....

23. (a) There are five numbers. Some information of the numbers are as shown.

$$\text{Range} = 6 \quad \text{mean} = 7 \quad \text{median} = 8 \quad \text{mode} = 9$$

Find the numbers.

*Ans:* \_\_\_\_\_, \_\_\_\_\_, \_\_\_\_\_, \_\_\_\_\_, \_\_\_\_\_ [2]

- (b) The average mass of 5 boys is 68 kg and that of 8 girls is 55 kg. To find the average mass of all the children, Caleb takes the average of 68 kg and 55 kg. Explain why Caleb is wrong and find the correct answer.

*Answer*

.....  
 .....  
 .....  
 .....

[2]

24. In the scale drawing,  $PQRS$  represents a plot of land, which is to be used for a park.  
**Scale 1 cm to 0.5 km**

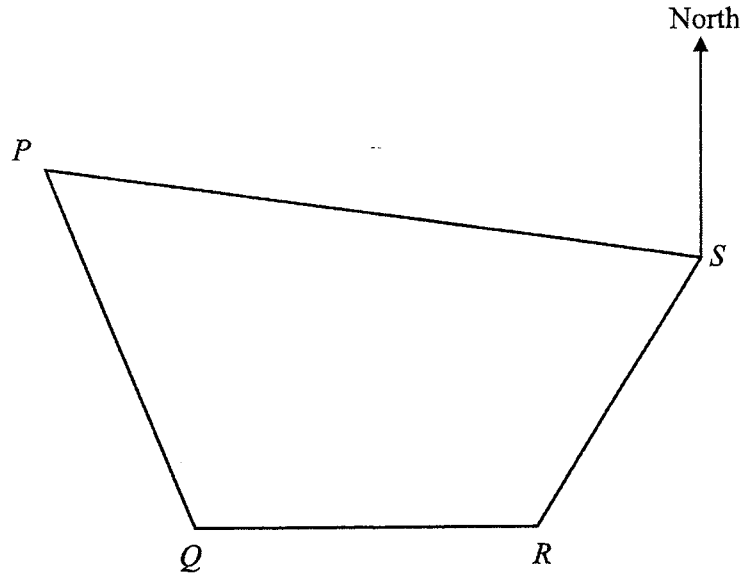

- (a) Find the actual distance between  $P$  and  $Q$ .

*Ans:* \_\_\_\_\_ km [2]

- (b) Measure the bearing of  $P$  from  $S$ .

*Ans:* \_\_\_\_\_ ° [1]

- (c) Construct the angle bisector of  $\angle PQR$ .

[1]

- (d) Construct the perpendicular bisector of  $RS$ .

[1]

- (e) A water fountain is to be built in the park, nearer to  $R$  than to  $S$  and equidistant to  $PQ$  and  $QR$ . Mark a possible location for the water fountain to be built and label it as  $F$ .

[1]



25. Emmett is going to Europe for a study exchange. The exchange rate between the Euro and Singapore dollar changes each day. The graph shows the daily exchange rate in a particular month.

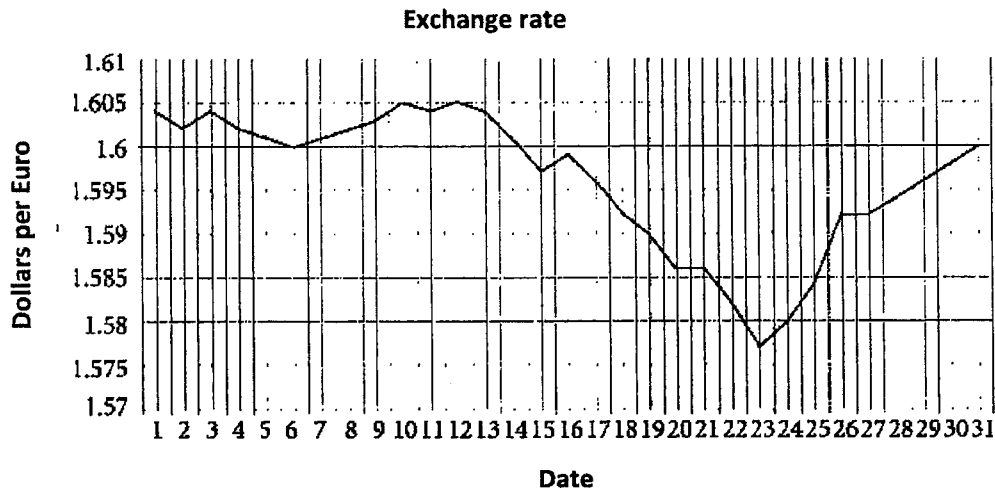

- (a) Emmett went to the money changer on the 6<sup>th</sup> to change \$1200 to Euros. How much Euros will he get?

*Ans:* \_\_\_\_\_ Euros [1]

- (b) The accommodation per night at Europe is 120 Euros. Emmett wanted to convert the accommodation cost to dollars. Use the graph to work out the difference between the greatest and least possible accommodation costs per night in dollars.

*Answer*

[3]

**-End of Paper-**

Name:	Index Number:	Class:
-------	---------------	--------



**HUA YI SECONDARY SCHOOL**

**4E/5N** Preliminary Examination 2022 **4E/5N**

**MATHEMATICS** **4048/2**

Paper 2

30 August 2022  
2 hours 30 minutes

Candidates answer on the Answer Space provided.

**READ THESE INSTRUCTIONS FIRST**

Write your Name, Class and Index Number in the spaces provided at the top of this page.  
Write your answers in the spaces provided on the question paper.  
Write in dark blue or black pen.  
You may use an HB pencil for any diagrams or graphs.  
Do not use staples, paper clips, glue or correction fluid.

Answer **all** questions.  
If working is needed for any question it must be shown in the space below with the answer.  
Omission of essential working will result in loss of marks.  
The use of an approved scientific calculator is expected, where appropriate.  
If the degree of accuracy is not specified in the question, and if the answer is not exact, give the answer to three significant figures. Give answers in degrees to one decimal place.  
For  $\pi$ , use either your calculator value or 3.142, unless the question requires the answer in terms of  $\pi$ .

The number of marks is given in brackets [ ] at the end of each question or part question.  
The total of the marks for this paper is 100.

**For Examiner's Use**

---

100

This document consists of 19 printed pages including the cover page.  
© HYSS 2022

No part of this document may be reproduced in any form or transmitted in any form or by any means without the prior permission of Hua Yi Secondary School.

**[Turn Over**

**Mathematical Formulae****Compound interest**

$$\text{Total amount} = P \left( 1 + \frac{r}{100} \right)^n$$

**Mensuration**

$$\text{Curved surface area of a cone} = \pi r l$$

$$\text{Surface area of a sphere} = 4\pi r^2$$

$$\text{Volume of a cone} = \frac{1}{3} \pi r^2 h$$

$$\text{Volume of a sphere} = \frac{4}{3} \pi r^3$$

$$\text{Area of triangle } ABC = \frac{1}{2} ab \sin C$$

$$\text{Arc length} = r\theta, \text{ where } \theta \text{ is in radians}$$

$$\text{Sector area} = \frac{1}{2} r^2 \theta, \text{ where } \theta \text{ is in radians}$$

**Trigonometry**

$$\frac{a}{\sin A} = \frac{b}{\sin B} = \frac{c}{\sin C}$$

$$a^2 = b^2 + c^2 - 2bc \cos A$$

**Statistics**

$$\text{Mean} = \frac{\sum fx}{\sum f}$$

$$\text{Standard deviation} = \sqrt{\frac{\sum fx^2}{\sum f} - \left( \frac{\sum fx}{\sum f} \right)^2}$$

Answer **all** the questions.

1. John and Peter took part in a marathon race. They each ran 42 km.

(a) John ran at a constant speed of  $x$  kilometres per hour.

Write down an expression, in terms of  $x$ , for the number of hours he took.

*Ans:* \_\_\_\_\_ h [1]

(b) Peter ran at a constant speed which was  $\frac{1}{2}$  km/h more than John's speed.

Write down an expression, in terms of  $x$ , for the number of hours he took.

*Ans:* \_\_\_\_\_ h [1]

(c) The difference between their times was 15 minutes.

(i) Write down an equation in  $x$  to represent this information, and show that it reduces to  $2x^2 + x - 168 = 0$ .

*Answer:* \_\_\_\_\_ [3]

(ii) Solve the equation  $2x^2 + x - 168 = 0$ , giving your answers correct to 3 decimal places.

*Ans:*  $x =$  \_\_\_\_\_ or \_\_\_\_\_ [3]

(iii) Calculate the time that Peter took to complete the race, giving your answer in hours and minutes.

*Ans:* \_\_\_\_\_ h \_\_\_\_\_ min [2]

2. (a) In the diagram,  $OAB$  is a sector of a circle with centre  $O$ . Given that  $OA = 12$  cm,  $\angle AOB = \theta$  radians,  $OC = 8$  cm and the length of the arc  $AB = 15$  cm.

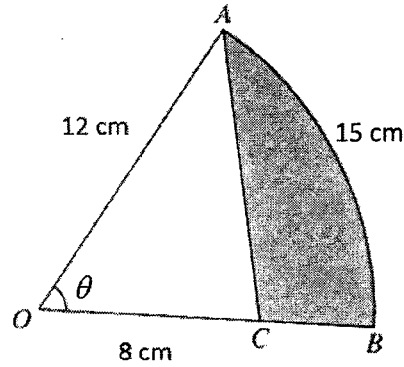

- (i) Calculate the value of  $\theta$ .

*Ans:* \_\_\_\_\_ [1]

- (ii) Find the area of the shaded region.

*Ans:* \_\_\_\_\_  $\text{cm}^2$  [3]

- (iii) Calculate the perimeter of the shaded region.

*Ans:* \_\_\_\_\_ cm [2]

- (b) In the diagram,  $A, B, C$  and  $D$  are four points on a circle, centre  $O$ .  
 $DO$  and  $CB$  are parallel.  
 Find, giving reasons for each answer,

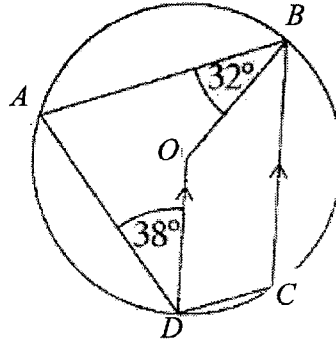

- (i) angle  $DAB$ ,

Ans: \_\_\_\_\_ ° [1]

- (ii) angle  $DOB$ ,

Ans: \_\_\_\_\_ ° [1]

- (iii) angle  $ODC$ .

Ans: \_\_\_\_\_ ° [2]

3.

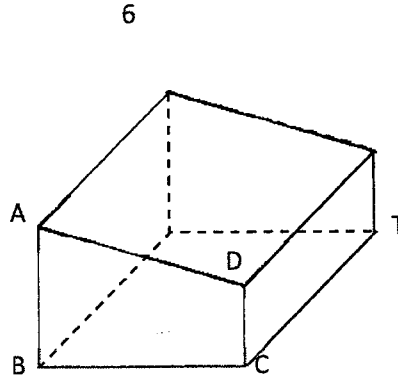

The diagram shows a solid trapezoidal prism with four rectangular faces.  
 $AB = 10\text{cm}$ ,  $BC = 12\text{cm}$ ,  $DC = 6\text{cm}$  and  $CT = 16\text{cm}$ .

- (a) Show that  $AD = 12.649\text{ cm}$ , correct to 5 significant figures.

*Answer*

[2]

- (b) Calculate the surface area of the prism.

- (c) Calculate the volume of the prism.

*Ans:* \_\_\_\_\_  $\text{cm}^2$  [3]

*Ans:* \_\_\_\_\_  $\text{cm}^3$  [2]

4. The figure shows a triangle  $ABC$ .  $E$  is the mid-point of  $AC$ .  $\overrightarrow{AB} = 3\mathbf{a}$  and  $\overrightarrow{AC} = 3\mathbf{c}$ .  $K$  lies on  $EB$  such that  $EB = 3EK$ .

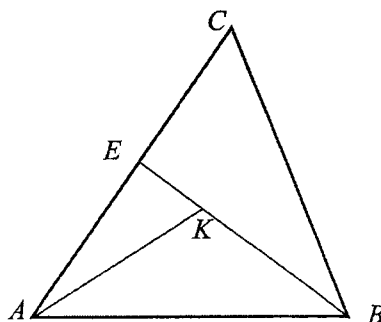

- (a) Express  $\overrightarrow{BC}$  in terms of  $\mathbf{a}$  and  $\mathbf{c}$ , as simply as possible.

*Ans:*  $\overrightarrow{BC} =$  \_\_\_\_\_ [1]

- (b) Express  $\overrightarrow{EB}$  in terms of  $\mathbf{a}$  and  $\mathbf{c}$ , as simply as possible.

*Ans:* = \_\_\_\_\_ [1]

- (c) Given that  $\overrightarrow{KP} = \frac{1}{2}\mathbf{a} + \frac{1}{2}\mathbf{c}$ , explain why  $A$ ,  $K$  and  $P$  lies on a straight line.

*Answer*

[3]

- (d) Find the value of  $\frac{\text{area of } \triangle AEK}{\text{area of } \triangle AKB}$ .

*Ans:* \_\_\_\_\_ [1]

- (e) Find the value of  $\frac{\text{area of } \triangle AEK}{\text{area of } \triangle ABC}$ .

*Ans:* \_\_\_\_\_ [1]



5. The diagram shows the speed-time graph of a motorcyclist. The shaded area represents the distance travelled. The distance travelled is 450m.

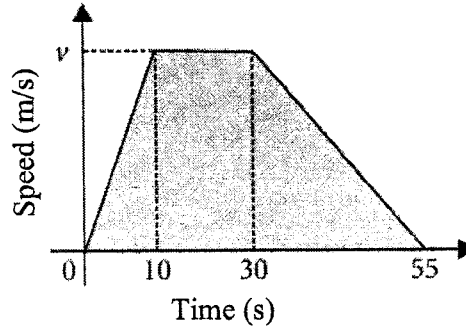

- (a) Show that  $v = 12$ .

[2]

*Answer*

- (b) Find the speed of the motorcyclist after 8 seconds.

*Ans:* \_\_\_\_\_ m/s [2]

- (c) Describe the motion of the motorcyclist between 10 and 30 seconds.

[1]

*Answer*

.....

.....

(d) Find the deceleration of the motorcyclist for the last 25 seconds.

Ans: \_\_\_\_\_ m/s<sup>2</sup> [1]

(e) Sketch the distance time graph for the journey on the grid.

Answer

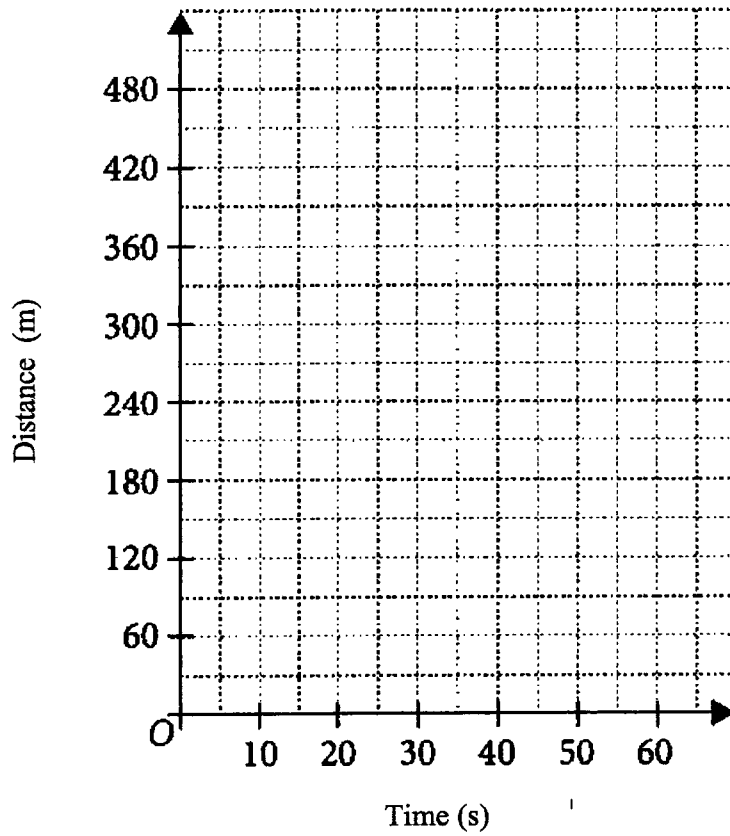

[3]

6. The variables  $x$  and  $y$  are connected by the equation  $y = \frac{x^3}{5} - 2x + 1$ . Some corresponding values of  $x$  and  $y$  are given in the table below.

$x$	-4	-3	-2	-1	0	1	2	3	4
$y$	-3.8	1.6	$p$	2.8	1	-0.8	-1.4	0.4	5.8

- (a) Find the value of  $p$ .

*Ans:*  $p =$  \_\_\_\_\_ [1]

- (b) On the graph paper on page 11, draw the graph of  $y = \frac{x^3}{5} - 2x + 1$  for  $-4 \leq x \leq 4$ . [3]
- (c) Using your graph, find the value of  $m$  such that the graph of  $y = mx - 2$  intersect the curve at exactly 2 points.

*Ans:*  $m =$  \_\_\_\_\_ [2]

- (d) Using your graph, explain why  $\frac{x^3}{5} - 2x - 3 = 0$  has only one solution.

*Answer*

[2]

.....

.....

- (e) On the same axes, draw the graph of  $2y + x = 4$ . [1]
- (f) Show that the  $x$  coordinates of the points of intersection of the line and the curve give the solutions to the equation  $2x^3 - 15x - 10 = 0$ .

*Answer*

[3]

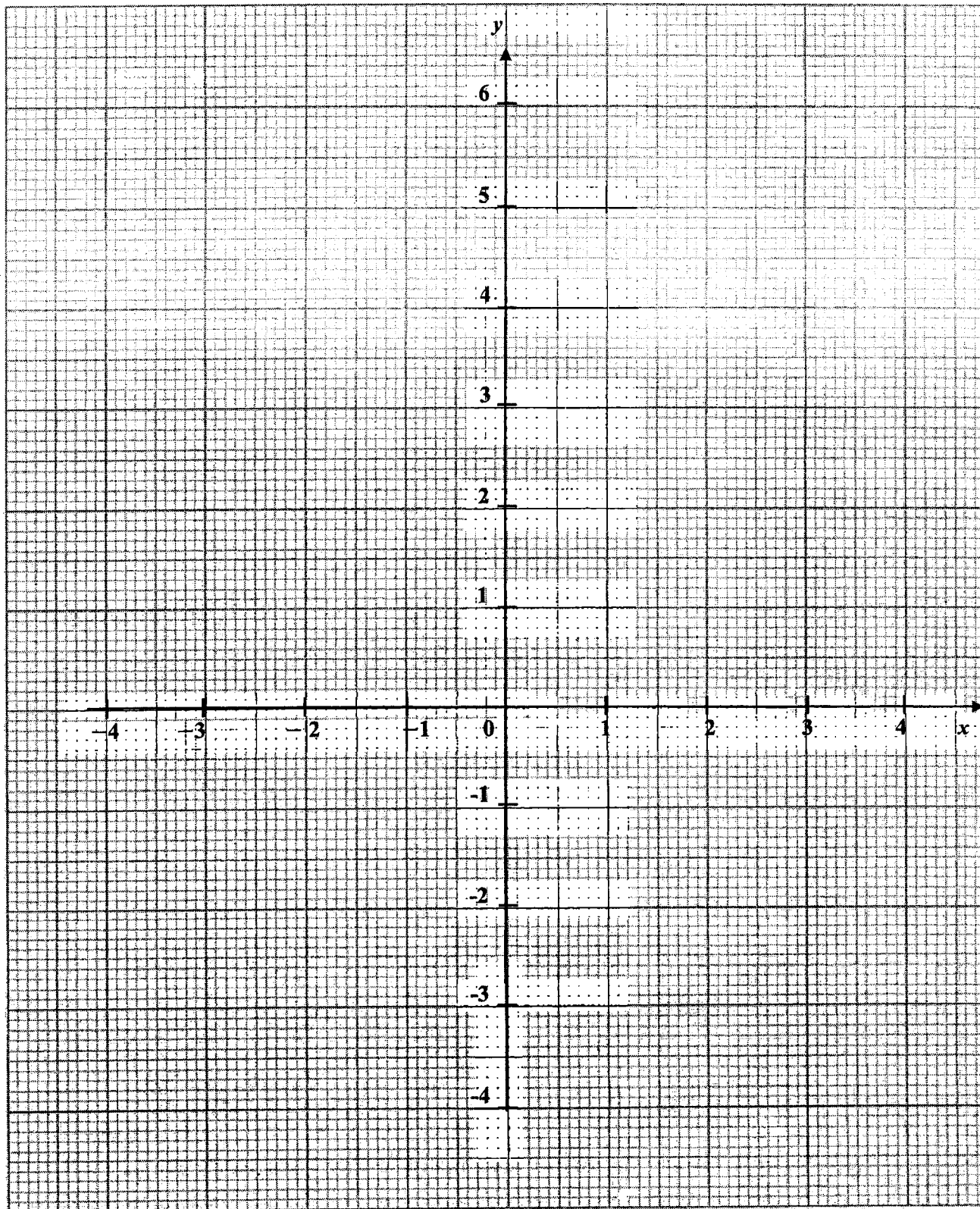

7. Airport  $B$  is 500 km away from airport  $A$  on a bearing of  $064^\circ$ . An aircraft leaves airport  $A$  at 22 45 on Monday to fly to airport  $B$ . Its speed during the flight is 375 km/h.

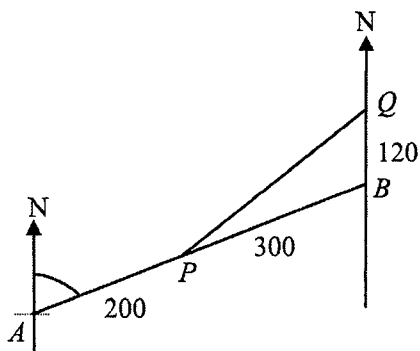

- (a) Calculate the time at which the aircraft is expected to arrive at airport  $B$ .

*Ans:* \_\_\_\_\_ [2]

After the aircraft has travelled 200 km at  $P$ , it is diverted to airport  $Q$  because of bad weather at airport  $B$ . Airport  $Q$  is 120 km due north of airport  $B$ .

- (b) Calculate the distance of  $PQ$ .

*Ans:* \_\_\_\_\_ km [2]

- (c) Calculate the bearing of  $Q$  from  $P$ .

*Ans* \_\_\_\_\_  $^\circ$  [3]

8. (a) The waiting time,  $t$  in minutes, for 40 customers at two phone service shops, Shop A and Shop B, are as follows.

Shop A

$t$ ( min )	$0 < t \leq 5$	$5 < t \leq 10$	$10 < t \leq 15$	$15 < t \leq 20$
Frequency	5	12	8	15

Shop B

Mean = 13.2 min
Standard Deviation = 2.17 min

- (i) Calculate the mean waiting time for Shop A.

*Ans:* \_\_\_\_\_ min [1]

- (ii) Explain why your answer to (a)(i) is only an estimate.

*Answer*

.....

..... [1]

- (iii) Calculate the standard deviation for Shop A.

*Ans:* \_\_\_\_\_ min [1]

- (iv) Which shop would you choose to go to? Why?

*Answer*

.....

..... [1]

- (v) A customer went to Shop B and his waiting time is 13.2 min. If his waiting time is added to the data, will the mean and standard deviation of the new set of data increase, decrease or remain the same?

*Answer*

The mean will ..... [1]

The standard deviation will ..... [1]

- (b) A teacher recorded the individual time taken by 200 students to complete a cross-country race. The results are presented in the form of a cumulative frequency curve.

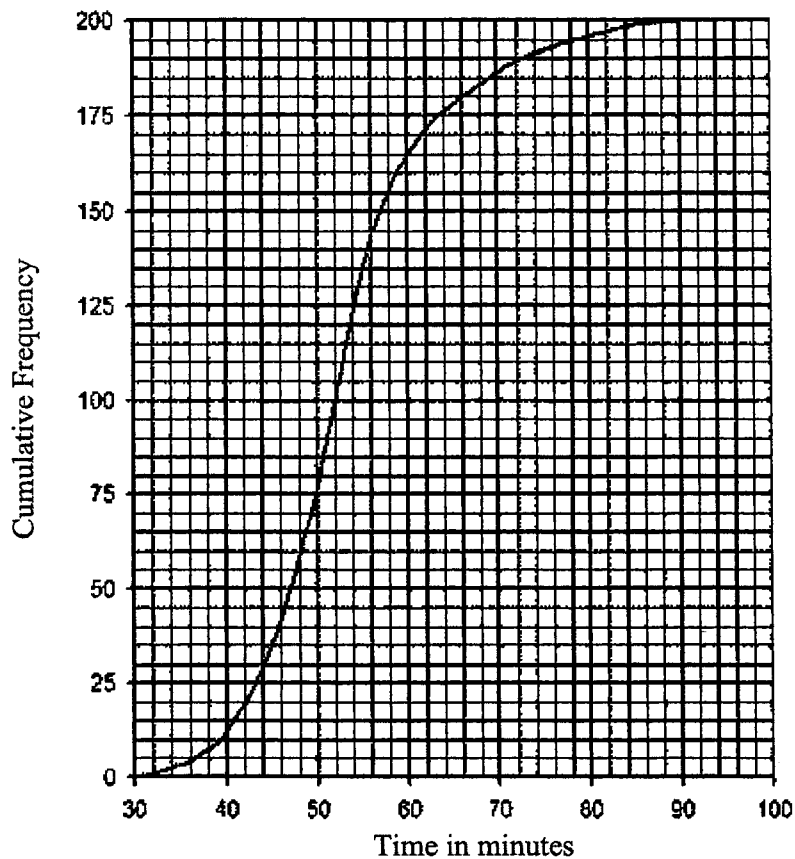

Use the graph to find

- (i) the median,

*Ans:* \_\_\_\_\_ min [1]

- (ii) the 90<sup>th</sup> percentile,

*Ans:* \_\_\_\_\_ min [1]

- (iii) the qualifying time to run in the second round if only 30 students qualify for the second round,

*Ans:* \_\_\_\_\_ min [1]

- (iv) the number of students who took more than 50 minutes but no more than 66 minutes.

*Ans:* \_\_\_\_\_ [2]

9. A cake shop sells 3 types of cakes.  
On Day 1, the shop sold 84 chocolate cakes, 90 vanilla cakes and 56 strawberry cakes.  
On Day 2, the shop sold 92 chocolate cakes, 60 vanilla cakes and 61 strawberry cakes.

(a) Represent this information by a  $2 \times 3$  matrix,  $P$ .

Ans:  $P =$  \_\_\_\_\_ [1]

The table shows the selling price and the profit for each type of cake.

	Chocolate	Vanilla	Strawberry
Selling Price of each cake	\$ 7	\$ 8	\$9
Profit made for each cake	\$4	\$3	\$5

(b) Find the matrix  $R = P \begin{pmatrix} 7 & 4 \\ 8 & 3 \\ 9 & 5 \end{pmatrix}$ .

Ans:  $R =$  \_\_\_\_\_ [1]

(c) Express the profit for Day 1 as a percentage of the total sale for Day 1.

Ans: \_\_\_\_\_% [1]

(d) Find the matrix  $M = \frac{1}{2} \begin{pmatrix} 1 & 1 \end{pmatrix} R$ .

Ans:  $M =$  \_\_\_\_\_ [1]

(e) Explain what each element in matrix  $M$  represents.

Answer

.....  
..... [1]



10. (a) The figure shows  $\triangle ABC$ .

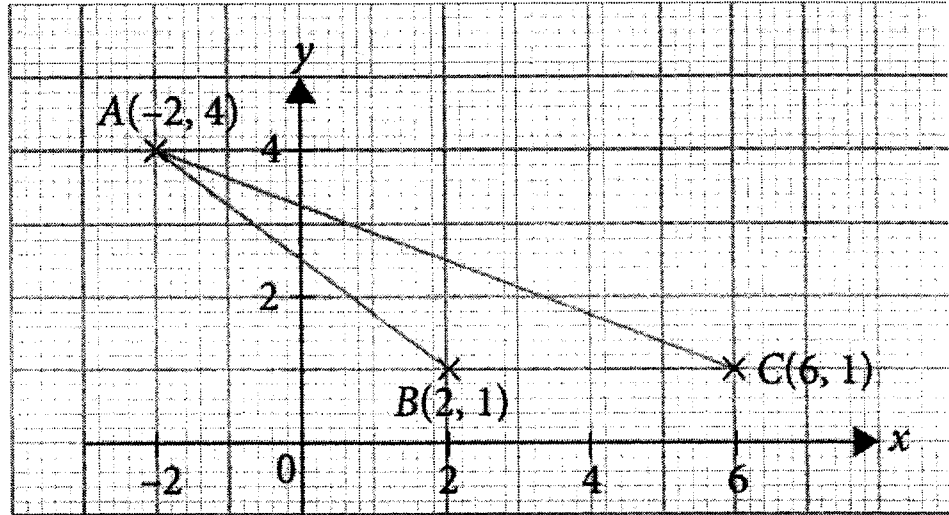

(i) May said that the line  $AC$  intersect the  $y$  axis at 3.2. Show how you would check if she is correct.

*Answer*

[2]

(ii) Find the length of  $AB$ .

*Ans:* \_\_\_\_\_ units [2]

- (iii) Without calculating the value of any angle, find the value of  $\cos \hat{A}BC$ .

*Ans:*  $\cos \hat{A}BC =$  \_\_\_\_\_ [1]

- (iv) The point  $P$  lies on the line  $y = 1$ . Given that area of  $\triangle ABC$  : area of  $\triangle APB = 4 : 3$ , find two possible  $x$  coordinates of  $P$ .

*Ans:*  $x =$  \_\_\_\_\_ or \_\_\_\_\_ [2]

- (b) Mr Johnson has a plot of field that grows dandelion plants. An average of 70 dandelion plants grow on each square metre. Each plant has an average of 10 flowers. Each flower will produce an average of 150 seeds. It is estimated that these plants will produce 130 000 000 seeds in total.

- (i) Mr Johnson packs the seeds in small packets. A packet consist of about 55 seeds. Find the number of packets of seeds he will get, giving your answer in standard form.

*Ans:* \_\_\_\_\_ [2]

- (ii) Calculate the area of the plot of field in square metres.

*Ans:* \_\_\_\_\_  $\text{m}^2$  [2]

11. Mrs Ang runs a small tuition centre for secondary school students. The tables provide information on the cost of running the centre. The centre is closed on Monday and Tuesday.

Start up cost	
Renovation	\$40 000
Furniture and IT equipments	\$ 5100

	Cost
Rental ( including utilities )	\$8 000 per month
Printing and stationery	\$100 per week

	Number of staff	Staff cost
Administrative	1	\$1800
Teaching	1 per class	\$70/h ( weekday) \$90/ h ( weekend)
Cleaning	1	\$45 per day ( 3 hr )

	Total number of classes on Weekdays	Total number of classes on Weekends	Fee per student *per month 1 lesson (2 h) /week
Lower Secondary	6	6	\$200
Upper Secondary	6	8	\$300

Number of students per class: 5 – 8.      \*1 month has 4 weeks

- (a) Mrs Ang took a loan for the renovation cost from a bank that charges 2% simple interest per annum. She opted to pay in 30 monthly instalments. Calculate the monthly instalment that Mrs Ang has to pay to the bank.

Ans: \$ \_\_\_\_\_ [2]

- (b) Mrs Ang bought the furniture and IT equipment at a 15% discount. Calculate her saving from the sale.

Ans: \$ \_\_\_\_\_ [2]

- (c) Mrs Ang targets to recover her start up cost and the interest incurred, within 6 months of operating her tuition centre.  
She also targets to make a profit of at least \$5000 per month thereafter.  
Will Mrs Ang hit her targets? Justify the decision you made and show your calculation clearly. State any assumptions made clearly.

*Answer*

[7]

**-End of Paper-**