



## 2020 PRIMARY 6 PRELIMINARY EXAMINATION

Name: \_\_\_\_\_ ( )

Date: 21 August 2020

Class: Primary 6 ( )

Time: 8.00 a.m. - 9.45 a.m.

Duration: 1 hour 45 minutes

Parent's Signature: \_\_\_\_\_

Marks: \_\_\_\_\_ / 56

# SCIENCE BOOKLET A

## INSTRUCTIONS TO CANDIDATES

1. Write your name, class and register number.
2. Do not turn over this page until you are told to do so.
3. Follow all instructions carefully.
4. Answer all questions.
5. Shade your answers on the Optical Answer Sheet (OAS) provided.

**Booklet A (28 x 2 marks)**

For each question from 1 to 28, four options are given. One of them is the correct answer. Make your choice (1, 2, 3 or 4) and shade your answer on the Optical Answer Sheet. (56 marks)

1. The process of photosynthesis is shown below.

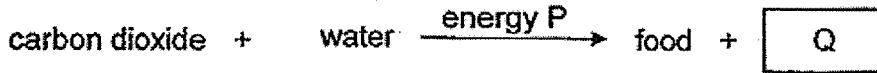

Identify energy P and substance Q.

	energy P	Q
(1)	light	water
(2)	light	oxygen
(3)	heat	water
(4)	heat	oxygen

2. Study the life cycles of the insects, M and N, as shown below.

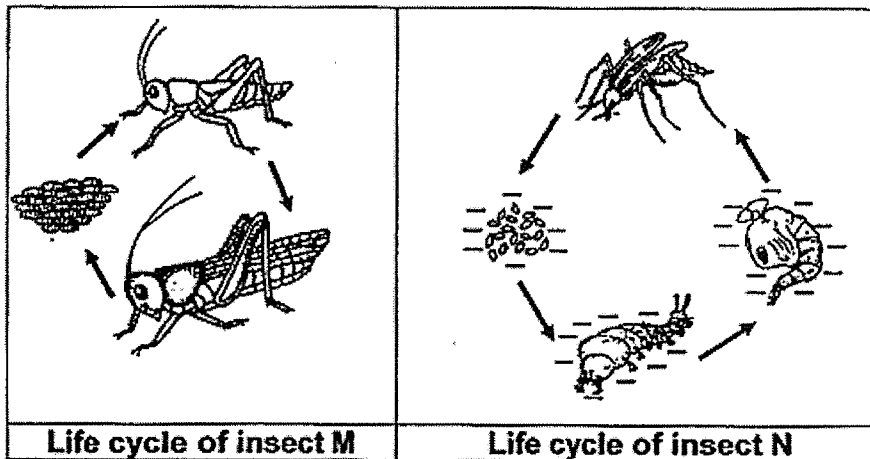

Based on the diagrams above, which of the following statements is true?

- (1) Both life cycles have the larval stage.
- (2) Insect M has more stages in its life cycle than insect N.
- (3) Insect M and insect N can live on land and in water.
- (4) The young of insect M looks like its adult but the young of insect N does not look like its adult.

3. Sarah placed one half of leaf Y in a sealed glass jar containing substance X and placed the set-up in the sun for a few hours.

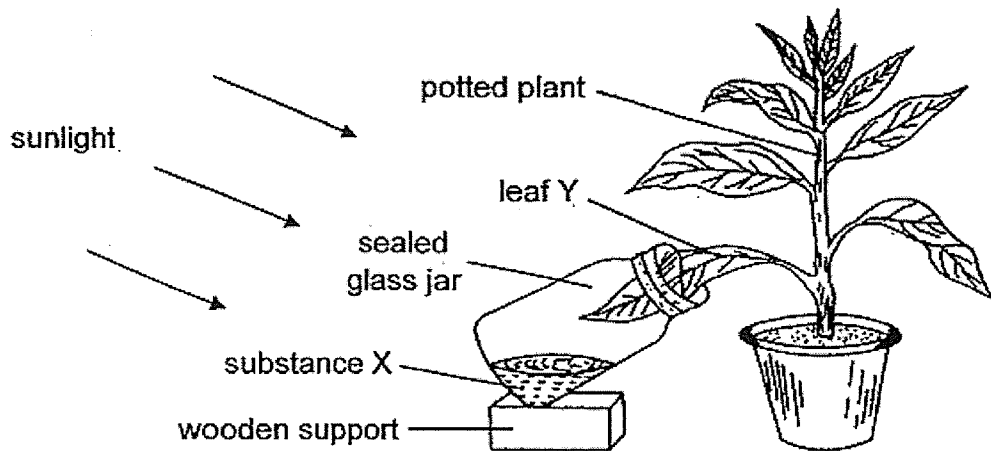

She then conducted a food test on leaf Y and the result of her experiment is shown below.

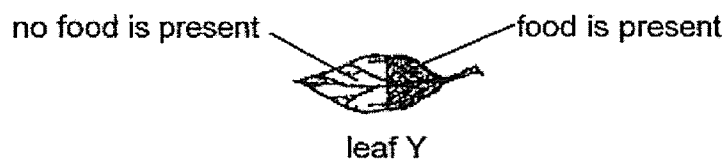

What is the purpose of substance X in the experiment?

- (1) To absorb oxygen
  - (2) To produce nitrogen
  - (3) To give out water vapour
  - (4) To absorb carbon dioxide
4. Nadia made the following observations about Organism Z over a period of time. The observations are stated in the box below.

- feeds on insects
- has webbed feet
- lays its eggs in water
- breathes through its moist skin

Which of the following groups of animals does Organism Z belong to?

- (1) fish
- (2) insect
- (3) reptile
- (4) amphibian

5. There were three types of flowering plants, R, S and T, grown in fields near a river as shown in Diagram 1.

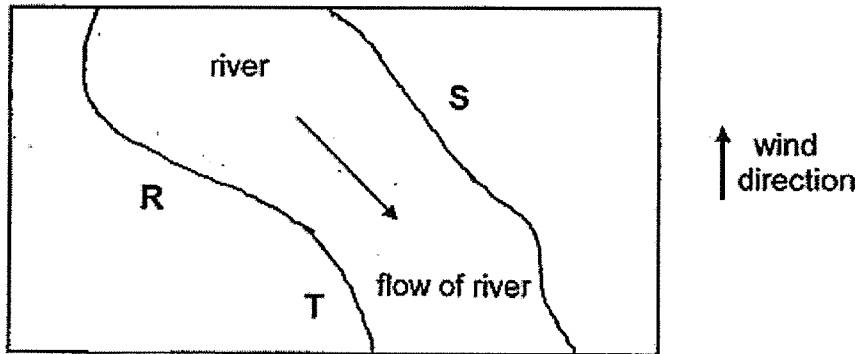

Diagram 1

A few years later, more of each plant, R, S and T, were found growing in the fields as shown in Diagram 2.

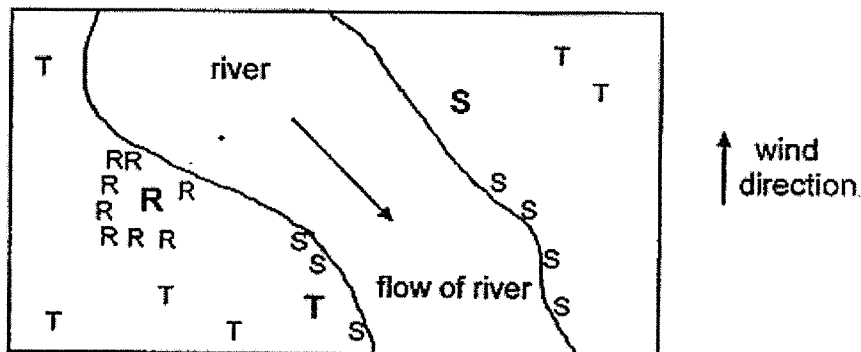
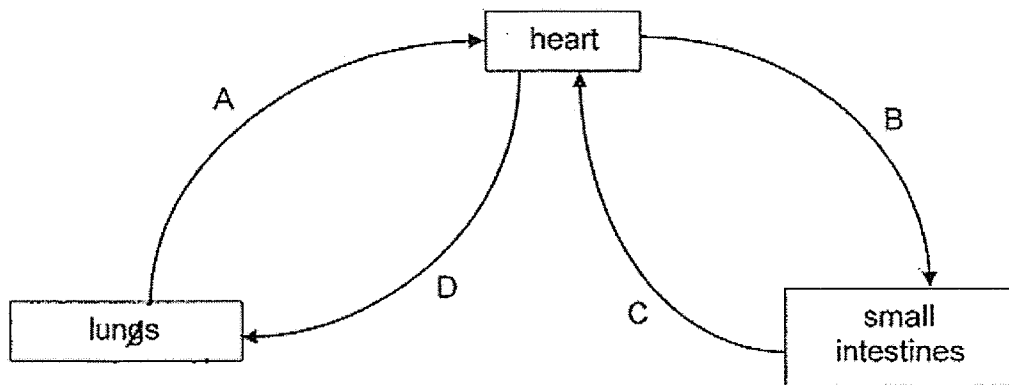

Diagram 2

Based on the distribution of plants in Diagram 2, which of the following are likely the characteristics of the fruits, R, S and T?

	Plant R	Plant S	Plant T
(1)	fleshy and brightly coloured	fibrous husk	hook-like structures
(2)	splits open when ripe	hook-like structures	wing-like structure
(3)	splits open when ripe	fibrous husk	fleshy and brightly coloured
(4)	fibrous husk	fleshy and brightly coloured	wing-like structure

6. The diagram below shows the directions of blood flow in some parts of the body.



The same amount of blood samples was taken from A, B, C and D after a meal. Which chart shows the correct comparison of substances in the blood samples?

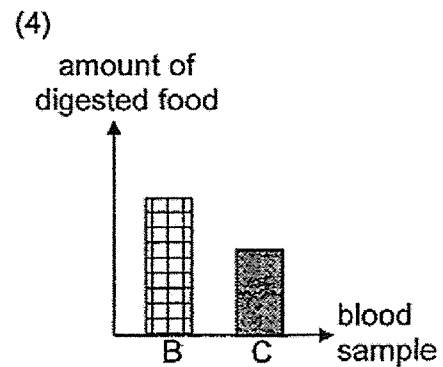
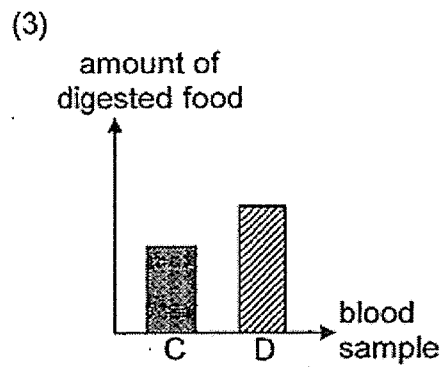
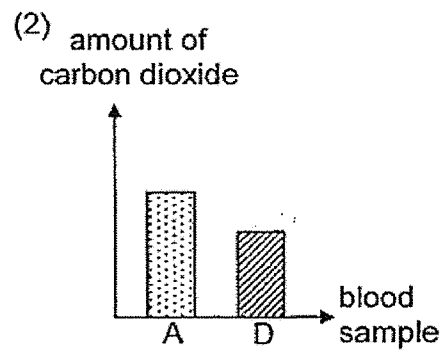
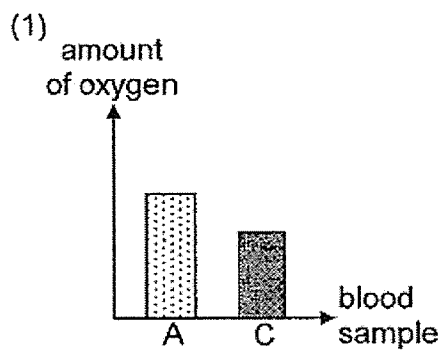

7. The diagram shows a plant cell.

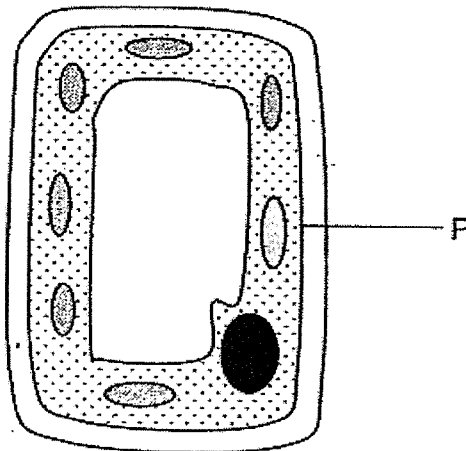

Which of the following statements is correct about P?

- (1) P gives the cell its shape.
- (2) P makes food for the cell.
- (3) P does not allow light to pass through.
- (4) P controls substances from entering and leaving the cell.

8. The diagram below shows how food passes through the digestive system of a human body.



Where does digestion take place?

- (1) R only
- (2) Q and R only
- (3) Q, R and S only
- (4) P, Q and R only

9. The table below shows some physical characteristics of both father and mother in a family.

Parent	Pointed Nose	Long Hair	Detached Earlobe
Father	√		
Mother		√	√

They have four children with the following physical characteristics.

Child	Pointed Nose	Long Hair	Detached Earlobe
Alan	√		√
Betty		√	
Charles	√		√
Daren		√	

Based only on the information above, which of the following statements are definitely true?

- A Betty and Daren are twins.
  - B Betty inherited at least one physical characteristics from her mother.
  - C Alan inherited one physical characteristics from his father.
  - D Charles inherited at least one physical characteristics from his parents.
- (1) A and D only  
(2) B and C only  
(3) C and D only  
(4) B, C and D only

10. The graph below shows the life cycle of insect X.

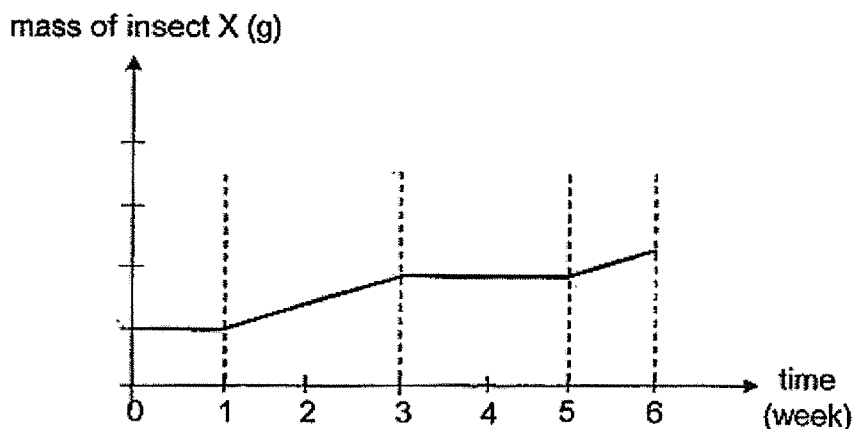

Based on the graph, how long does insect X take to develop into an adult after hatching?

- (1) two weeks
- (2) three weeks
- (3) four weeks
- (4) five weeks

11. Ted has the following set-ups.

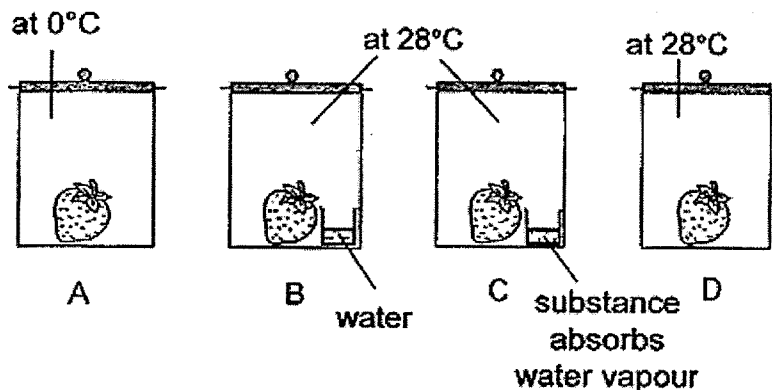

Based on the experiment, in which two set-ups would Ted most likely find mould on the strawberry after a few days?

- (1) A and C only
- (2) A and D only
- (3) B and C only
- (4) B and D only



12. Ali took a 10-minute slow walk from his house to a nearby park and rested on a bench for 10 minutes before he jogged home at a constant speed for 20 minutes. He then rested on his sofa.

Which of the following graphs best shows Ali's heart rate from the time he left home to the time he rested at home?

(1)

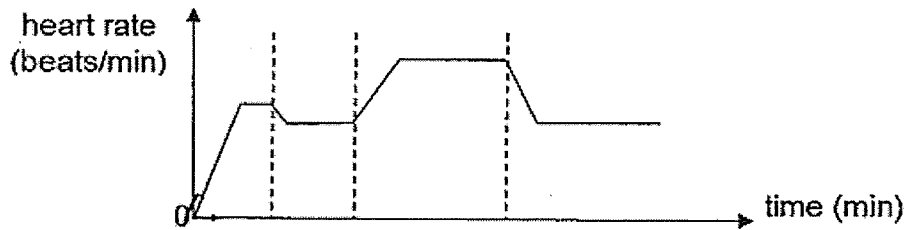

(2)

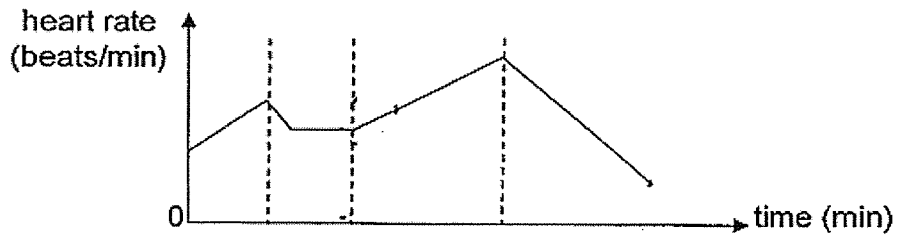

(3)

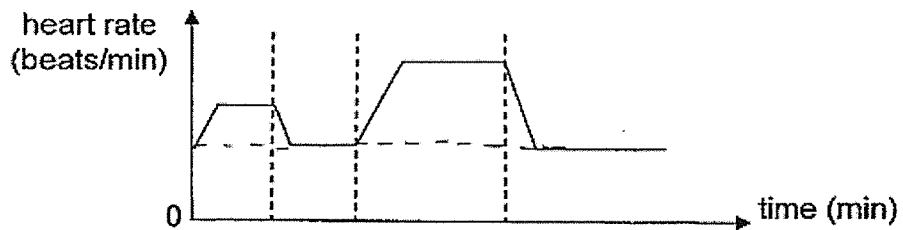

(4)

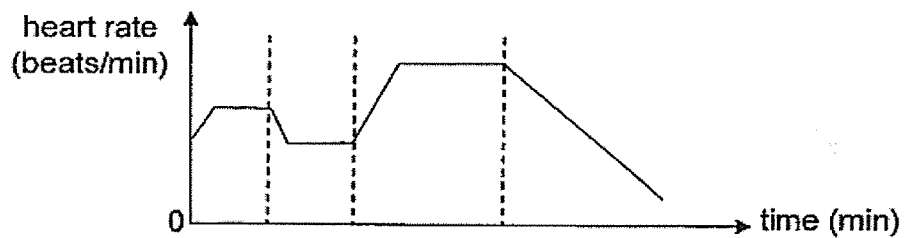

13. Study the classification chart below.

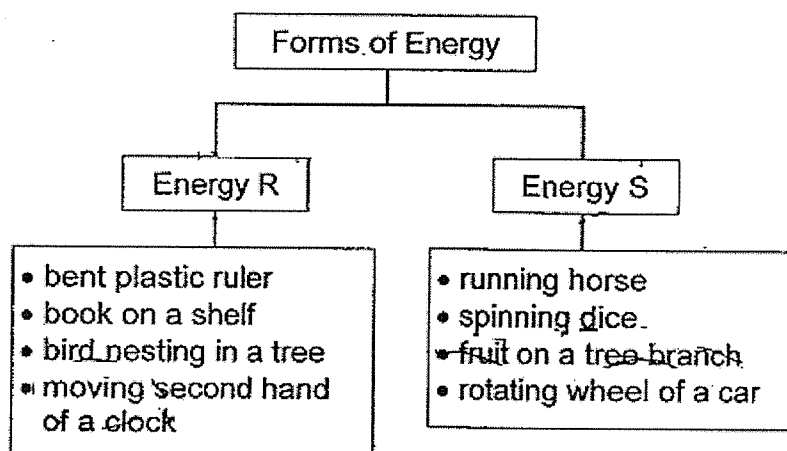

Which of the objects have been incorrectly classified?

	Energy R	Energy S
(1)	bent plastic ruler	spinning dice
(2)	moving second hand of a clock	fruit on a tree branch
(3)	bird nesting in a tree	rotating wheel of a car
(4)	book on a shelf	running horse

14. Ginny used rubber balls of identical material but of different masses to carry out the experiment below. She dropped a 20 g rubber ball from a height of 5 m. The ball then bounced up 3 m after hitting the ground as shown below.

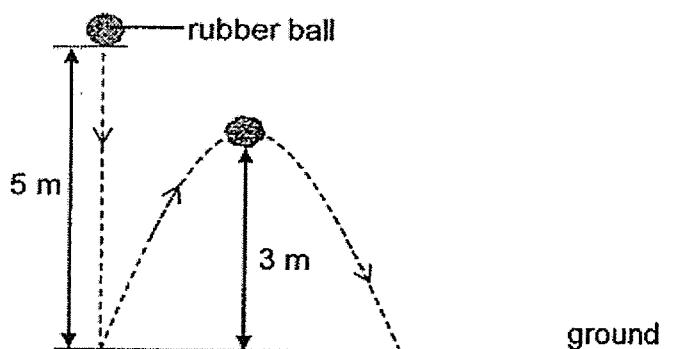

Which of the following should Ginny choose if she wants the ball to bounce higher than 3 m?

	Rubber Ball (g)	Height dropped from (m)
(1)	10	2
(2)	10	5
(3)	20	2
(4)	50	10

15. Johari was playing with his slingshot. He pulled the rubber band with a crushed paper ball as far as he could before he released the stretched rubber band as shown below. The crushed paper ball hit a marble so the marble moved.

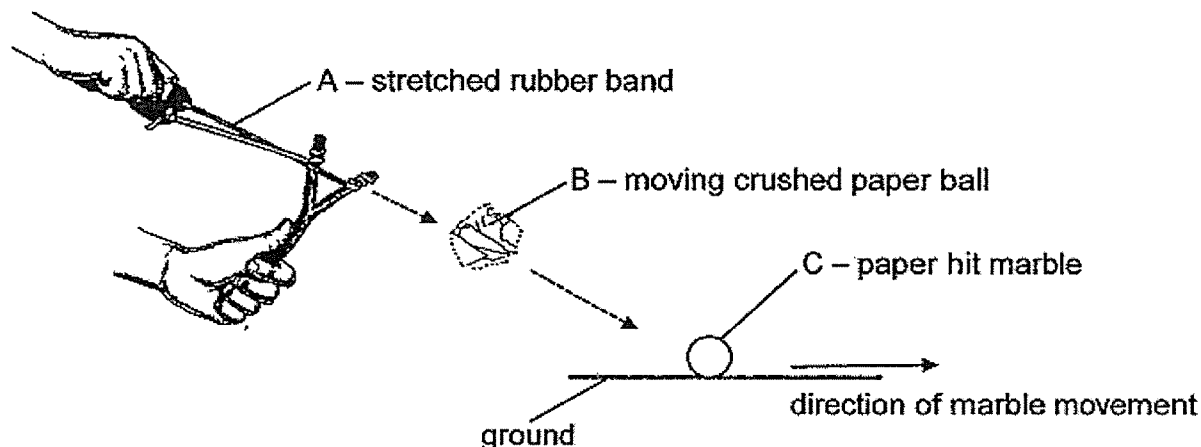

Which of the following correctly shows the energy conversion from point A to point C?

- (1) potential energy  $\rightarrow$  kinetic energy  $\rightarrow$  potential energy
  - (2) kinetic energy  $\rightarrow$  potential energy  $\rightarrow$  heat energy + sound energy
  - (3) potential energy  $\rightarrow$  kinetic energy  $\rightarrow$  kinetic energy + sound energy
  - (4) potential energy  $\rightarrow$  kinetic energy  $\rightarrow$  potential energy + sound energy
16. A toy car moved down a slope, past point Y and moved up beyond point Z before coming to a stop. After which, the toy car slid back down.

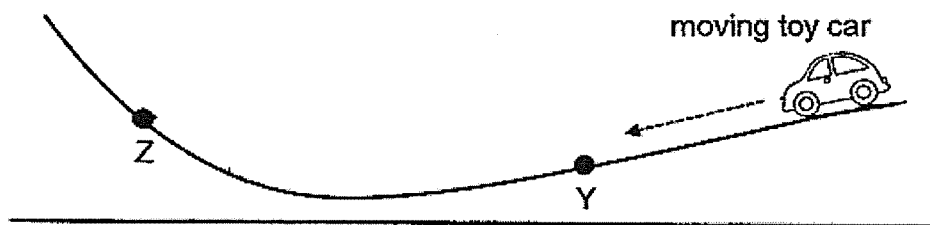

The amount of kinetic energy and potential energy of the toy car at points Y and Z are compared. Which of the following is correct?

	kinetic energy at Z compared to Y	potential energy at Z compared to Y
(1)	less	less
(2)	less	more
(3)	more	the same
(4)	the same	less

17. Mary has an inflatable swimming pool which can be folded when deflated and inflated with air to contain water as shown in diagrams below.

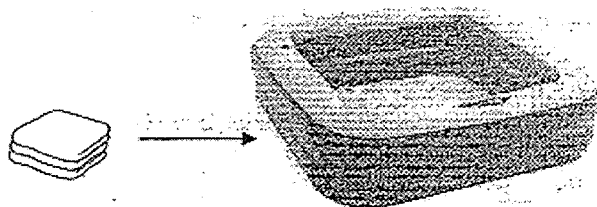

The table below shows the possible properties of the inflatable swimming pool. A tick (✓) indicates the presence of the property.

Which of the following are the properties necessary to make the above inflatable swimming pool?

Properties			
	Flexible	Strong	Waterproof
(1)	✓	✓	✓
(2)	✓		
(3)	✓	✓	
(4)			✓

18. Three bar magnets, AB, CD and EF, can be arranged as shown below.



Which of the following arrangements of the magnets is possible?

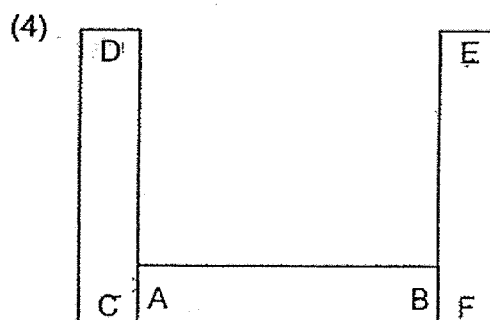
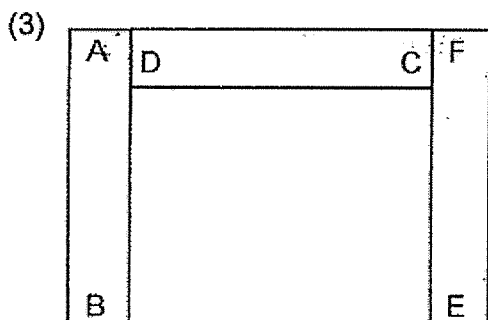
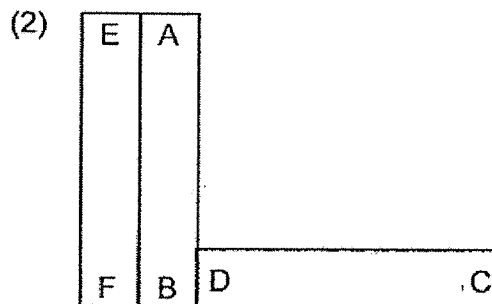
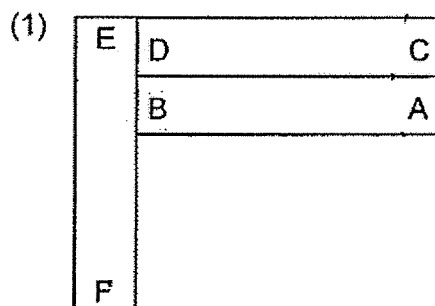

19. The diagram below shows a child sliding down a slide. The graph next to the diagram shows the amount of different types of energy at Point A as the child slides down the slide.

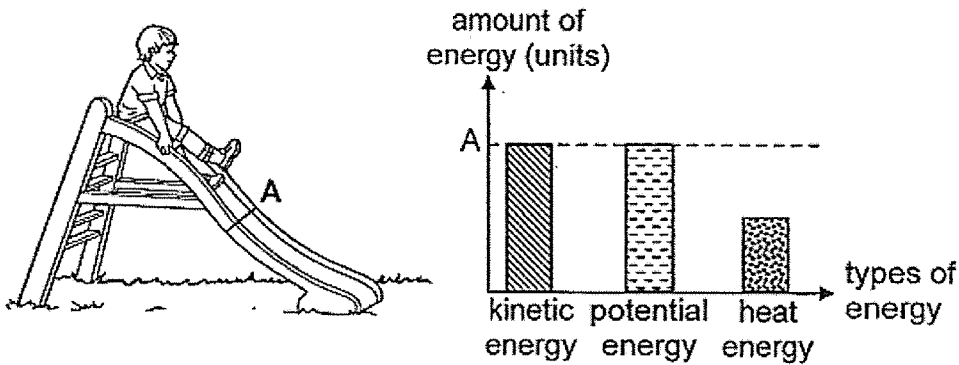

After a sudden downpour, the slide was wet but the child still continued to play.

Which graph correctly shows the change in the amount of different types of energy at A as the child slid down the wet slide?

(1)

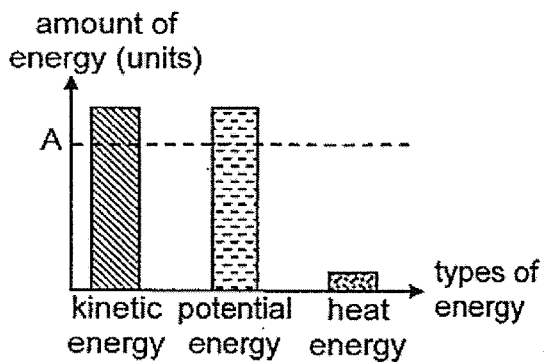

(2)

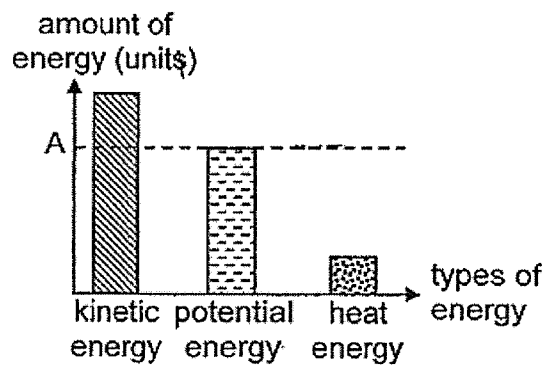

(3)

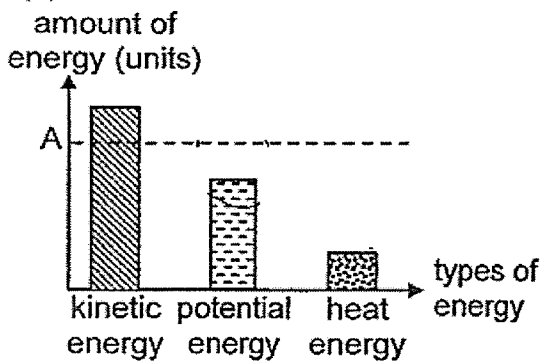

(4)

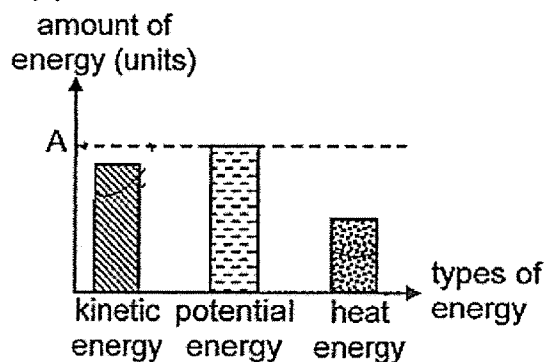

20. Chitra had 2 similar springs. When a 50 g mass was hung on one spring, she noticed that it extended.

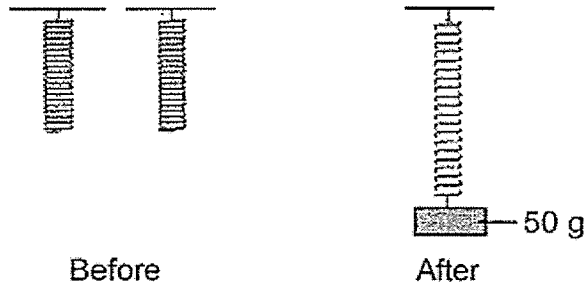

Which of the following will correctly show the extensions of the springs when different masses are hung on them?

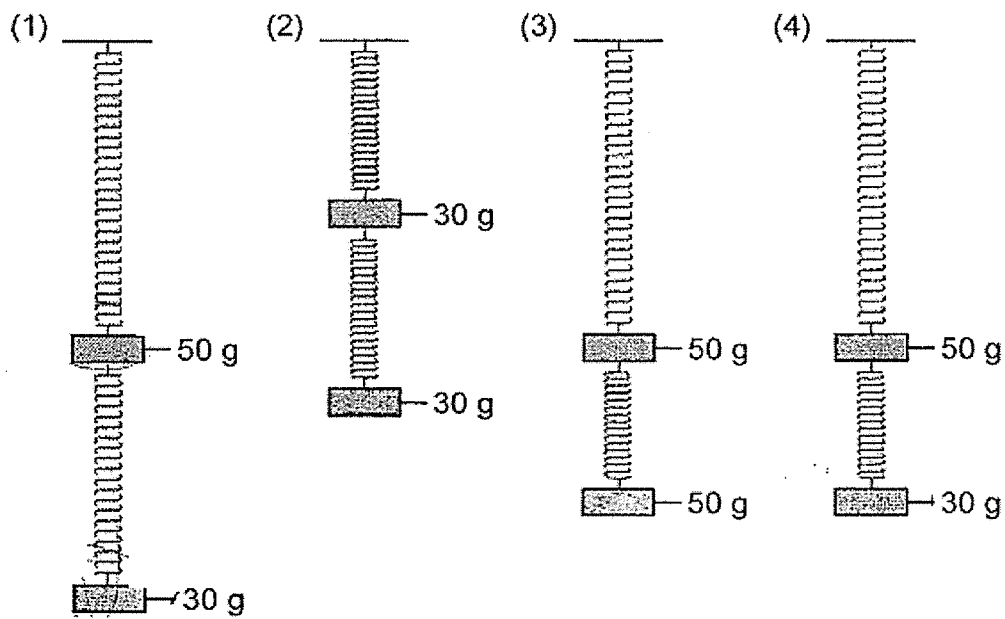

21. Two groups of people were playing 'tug-of-war' as shown below. Both teams had to pull at opposite ends of a rope. The winning team would be the one that managed to pull the centre ribbon across a central line towards themselves.

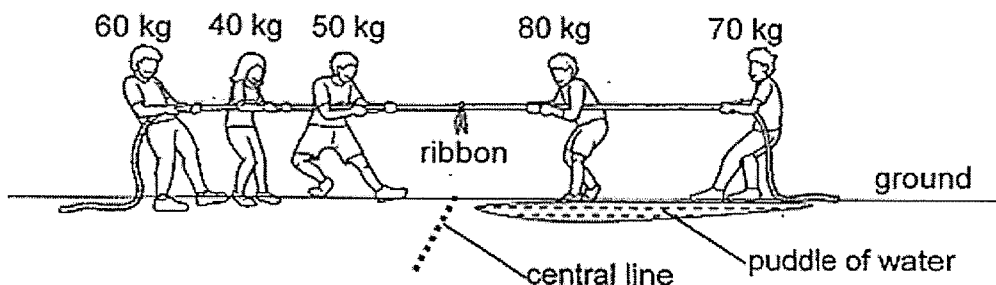

Which of the following explains why the game was not played fairly?

- A The number of participants in each team was different.
- B The frictional force between the shoes and the ground was different.
- C The difference in the total mass of each team affected the force exerted on the rope.

- (1) A and B only
- (2) A and C only
- (3) B and C only
- (4) A, B and C only

22. Shaun fully filled two identical containers with hot water. He then wrapped them in identical wet towels, C and D, of different temperatures as shown below.

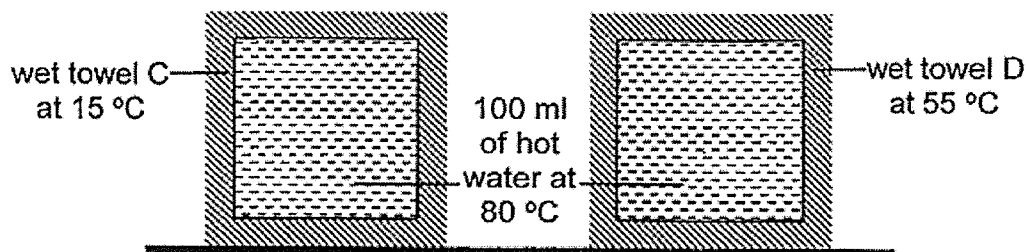

Which of the following observations did he make after 10 minutes?

	heat gain by towels	heat flow from
(1)	D gained more heat than C	towel to hot water
(2)	C gained more heat than D	hot water to towel
(3)	C and D did not gain heat	hot water to towel
(4)	C and D gained the same amount of heat at any given time	towel to hot water

23. Sarah was walking along a path from A to E with two street lamps, L1 and L2, positioned at B and E respectively.

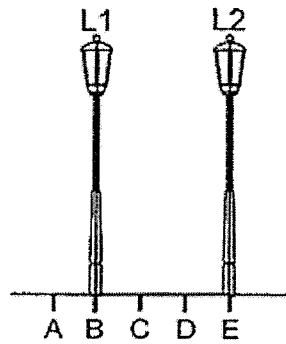

**Legend:**

- Shadow caused by L1
- - - - Shadow caused by L2

Which of the following graphs shows the correct changes in the length of her shadows as she walked from A to E?

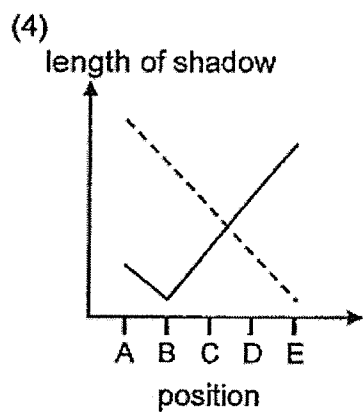
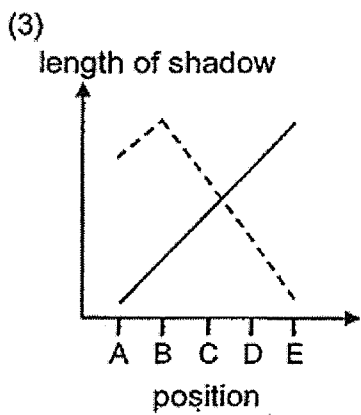
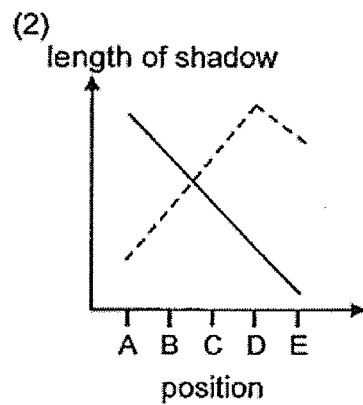
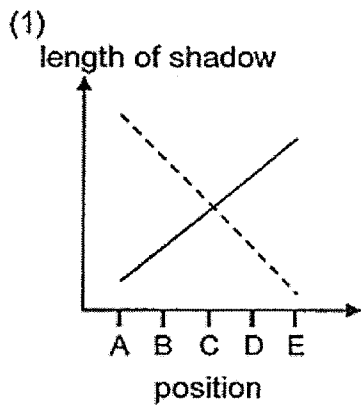



24. The diagram below shows a wooden board and a circuit tester. There are five metal pins, R, S, T, U and V, fixed onto the board. There are some hidden wires connected to the pins.

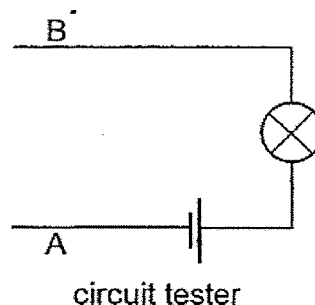
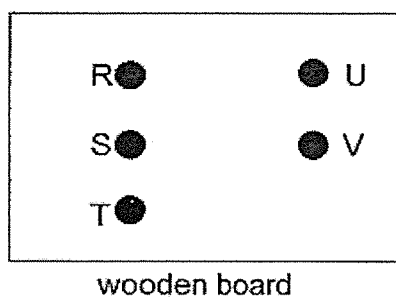

The bulbs would light up when some of the pins formed a closed circuit with the circuit tester. The results were recorded in the table below.

Pin connected to A	Pin connected to B	Did the bulb light up?
R	S	No
R	T	Yes
S	U	No
U	V	Yes

Which of the following shows the correct arrangement of the hidden wires on the wooden board?

(1)

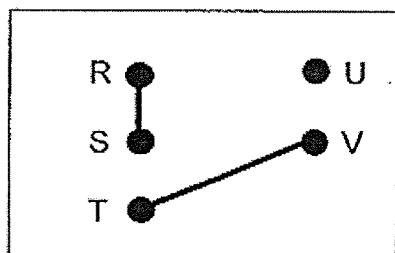

(2)

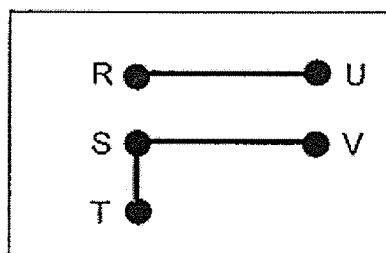

(3)

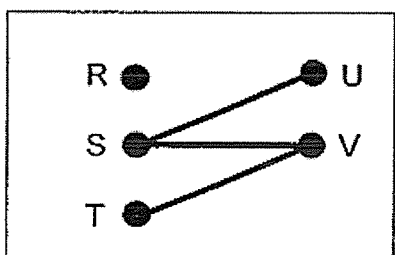

(4)

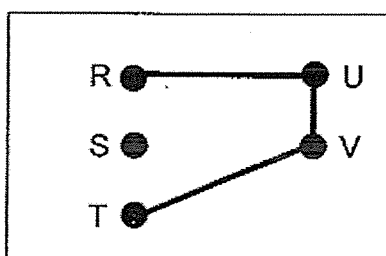

25. The diagram below shows the water cycle.

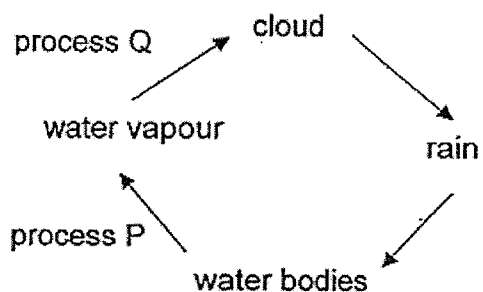

Based on the diagram above, which of the following statements is correct?

- (1) Heat is lost in process P.
- (2) Heat is gained in process Q.
- (3) Process P does not take place at a fixed temperature.
- (4) There is a change in state in process P but not in process Q.

26. The table below shows the melting points and boiling points of two substances, A and B.

Substance	Melting point (°C)	Boiling point (°C)
A	64	760
B	212	440

Which of the following shows the correct state(s) of substances A and B at 100°C?

	A	B
(1)	solid	liquid
(2)	liquid	solid
(3)	solid	solid
(4)	liquid	gas

27. Ring magnets S and T, were slipped through a wooden pole as shown below in diagram A.  $d$  is the distance between magnets S and T.

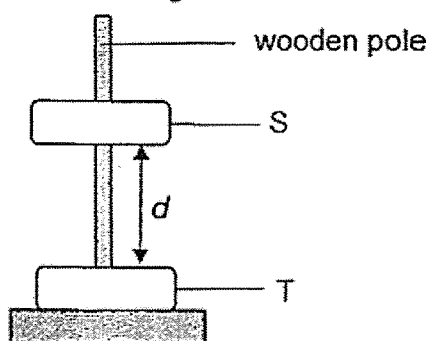

Diagram A

Different masses of load were placed above magnet S and distance  $d$  was measured as shown in diagram B.

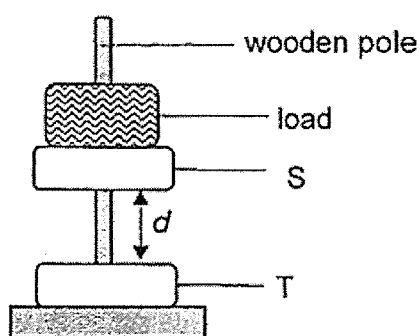

Diagram B

The results were recorded in the table below.

Mass of load (g)	Distance $d$ (cm)
0	15.0
10	12.2
20	7.3
50	0

Based on the results, which of the following statements is definitely true?

- (1) Magnet S is lighter than magnet T.
- (2) Unlike poles of magnet S and T are facing each other.
- (3) With increasing mass of load, greater gravitational force is acting against the magnetic force.
- (4) There is no magnetic force of repulsion between magnet S and T when the mass of load is 50g.

28. Four sheets of materials, J, K, L and M, are arranged in the two set-ups as shown below. One of the sheets is coloured. A non-coloured patch of bright light is seen on one of the sheets in set-up A but a coloured patch of dim light is seen on one of the sheets in set-up B.

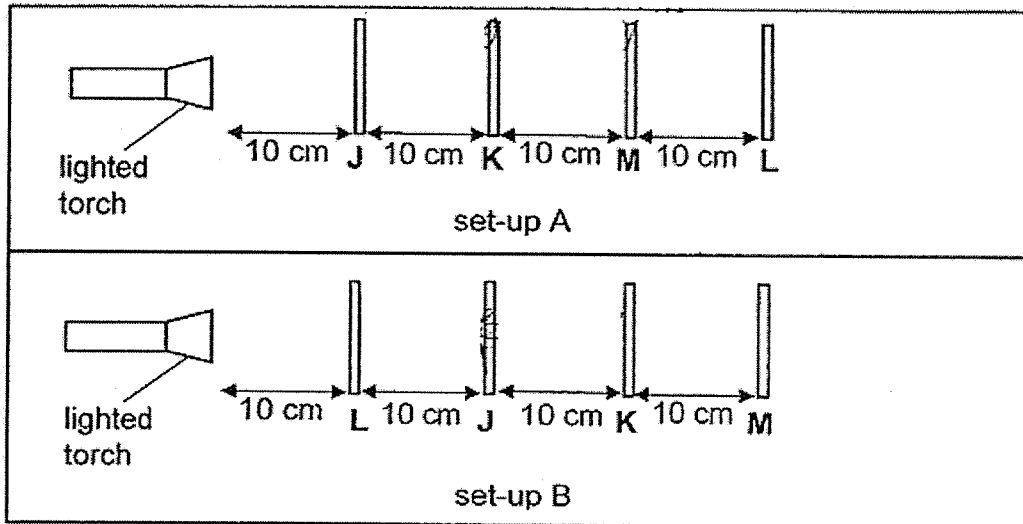

The distance travelled by the light for each set-up until a patch of light is seen is shown in the bar graph below.

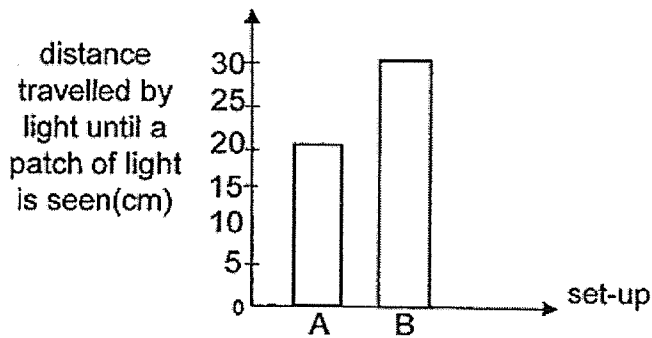

Which of the following correctly describes materials J, K, L and M?

	Allows most light to pass through	Does not allow light to pass through	Coloured sheet
(1)	K	M	J
(2)	L	K	M
(3)	J	K	L
(4)	J	L	K

End of Booklet A



## 2020 PRIMARY 6 PRELIMINARY EXAMINATION

Name : \_\_\_\_\_ ( )

Date: 21 August 2020

Class : Primary 6 ( )

Time: 8.00 a.m. - 9.45 a.m.

Duration: 1 hour 45 minutes

# SCIENCE

## BOOKLET B

### INSTRUCTIONS TO CANDIDATES





1. Write your name, class and register number.
2. Do not turn over this page until you are told to do so.
3. Follow all instructions carefully.
4. Answer all questions.
5. Write your answers in the booklet.

Booklet A	56
Booklet B	44
Total	100

For questions 29 to 41, write your answers clearly in this booklet.

The number of marks available is shown in brackets [ ] at the end of each question or part question. (44 marks)

29. Xiao Ming set up an experiment to find out the conditions required for seeds to germinate. The experimental conditions and results are shown below.

Tray	Soil	Presence of light	Observations on Day 7
A	wet	yes	
B	wet	no	
C	dry	yes	
D	dry	no	

- (a) From the above results, what condition(s) needed for germination can Xiao Ming conclude? [1]

---



---

Using the germinating seeds, Xiao Ming set up the apparatus at room temperature as shown below. In the set-up, the drop of red ink prevented air from entering the test tube.

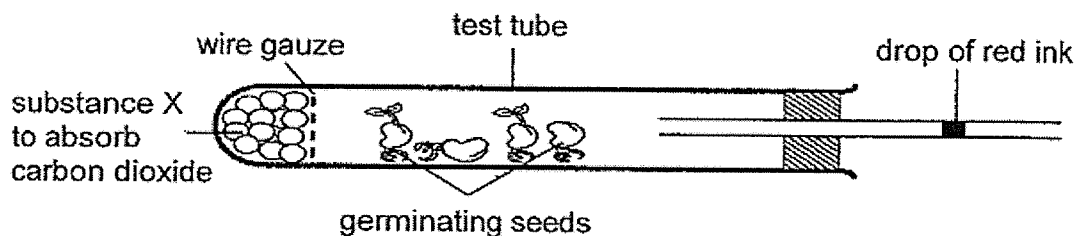

- (b) Explain why the drop of red ink moved towards the test tube after a few days. [2]

---



---



---

Score	3
-------	---

30. Amy conducted an experiment using two similar pots of plants, P and Q, to find out if the number of leaves affects the amount of water absorbed by the roots. She placed the potted plants in a garden and watered each of them with 300 ml of water at the start of the experiment.

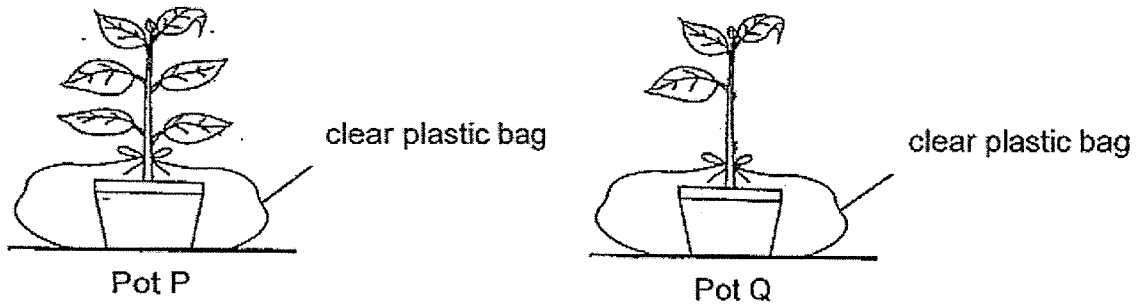

After a few days, Amy lifted pots P and Q with both her hands to compare their masses. However, Amy's teacher disagreed with Amy's method of measurement.

- (a) Explain how Amy should have measured the masses of the pots P and Q. [1]

---

---

Amy discovered many tiny insects using their mouths to pierce into the stem of a plant in her garden. They were feeding on the stem.

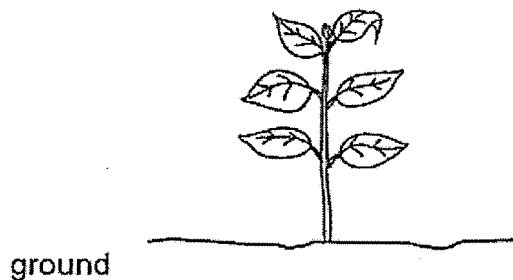

- (b) After a few days, the roots of the plant died. Explain why. [1]

---

---

Score	2
-------	---

31. Below are four flowers.

(a) Put a tick ( ✓ ) in the box(es) to indicate the flower(s) that is/are pollinated by animals. [1]

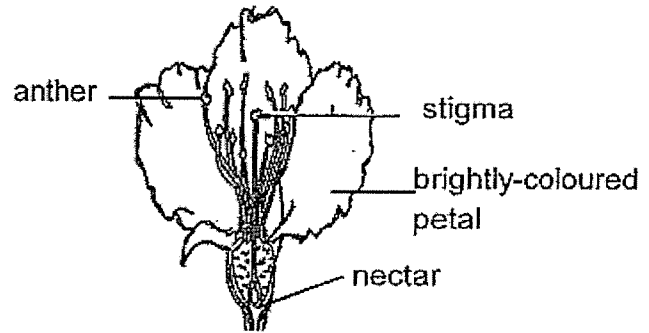
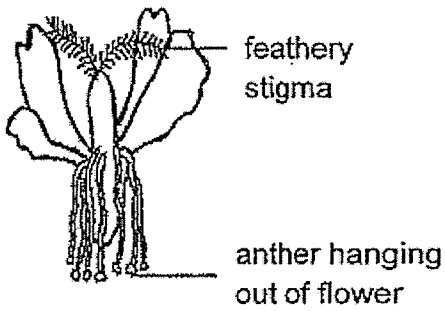

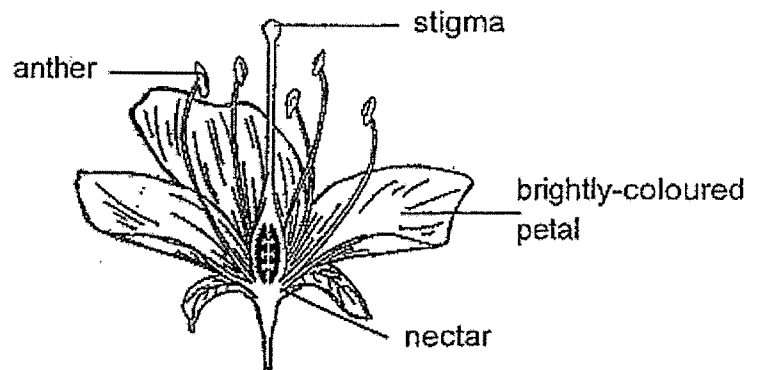
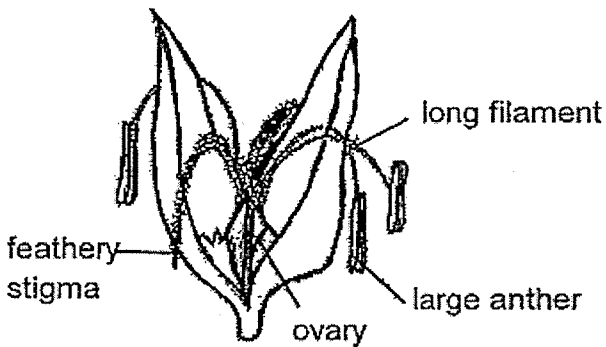

Score	1
-------	---



Birds A and B fly from flower to flower.

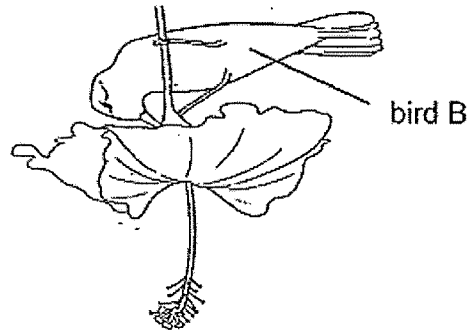
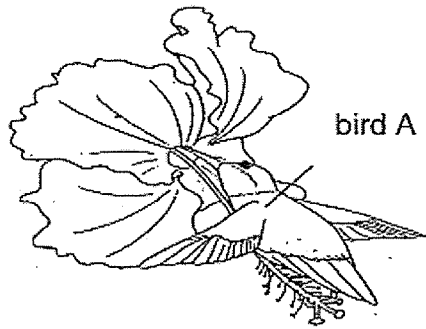

(b) Give a reason why birds A and B fly from flower to flower. [1]

---

(c) Which bird, A or B will most likely cause the flower to develop into a fruit?  
Explain how the bird helps in the fruit development. [2]

---

---

---

Score	3
-------	---

32. Kaixin left two set-ups, X and Y, of similar potted plants placed in glass containers under the sun for some time.

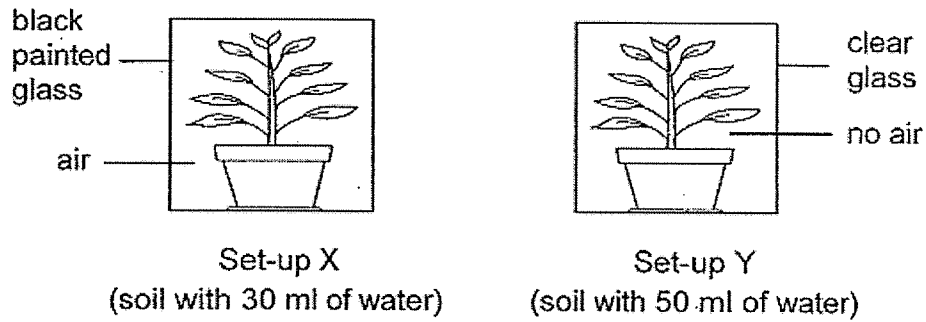

(a) Kaixin wants to use set-ups X and Y to test if plants need sunlight to make food. Describe the two changes that she must make to the set-ups in order for one of them to be the control set-up. [2]

(i) One change to set-up X: \_\_\_\_\_

\_\_\_\_\_

(ii) One change to set-up Y: \_\_\_\_\_

\_\_\_\_\_

Then, Kaixin wanted to find out how the intensity of light would affect the rate of photosynthesis of plants. She carried out the following experiment.

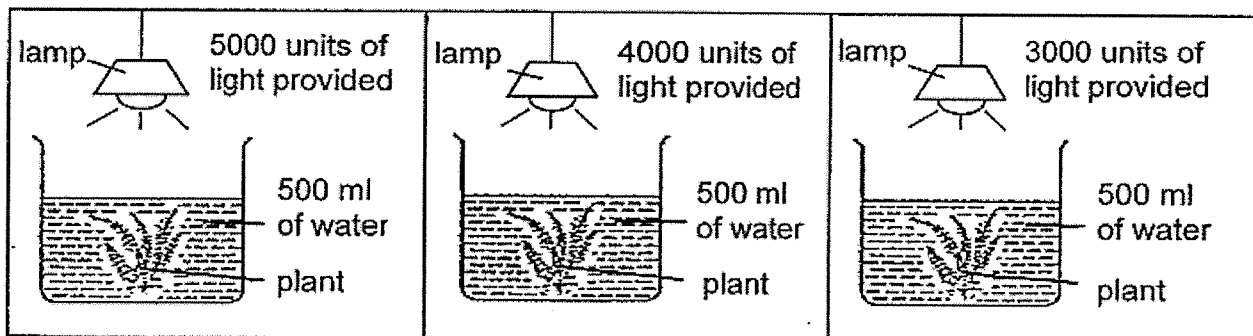

Score	2
-------	---

She recorded the time each plant took to produce 50 bubbles in the table below.

Light intensity (units)	Time taken for 50 bubbles to be produced (s)
5000	40
4000	45
3000	58

(b) The time taken for 50 bubbles to be produced decreases as light intensity increases. Explain why. [1]

---

---

(c) Kaixin conducted the experiment in a dark room. Give a reason why this helped to make the test a fair one. [1]

---

---

Kaixin realised that the fishes in her aquarium with water plants had been swimming to the surface of the water frequently.

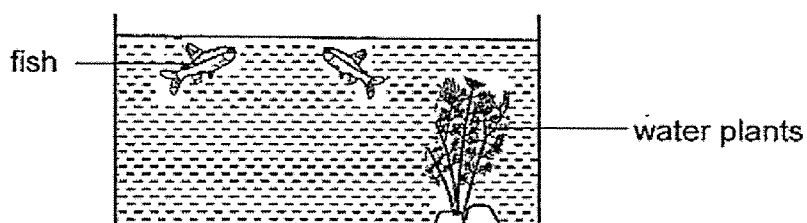

(d) Based on the results of her experiment above, what should she do to ensure that the fishes do not need to swim to the surface of the water anymore? [1]

---

---

Score	3
-------	---

33. Mountain K has a height of 8 840 m.

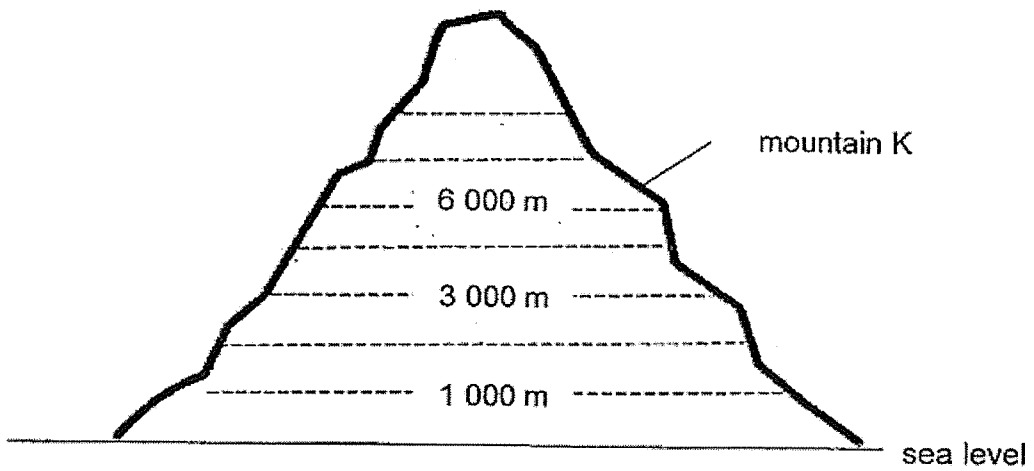

Graph 1 below shows how the percentage of oxygen in the surrounding air changes with the height above sea level.

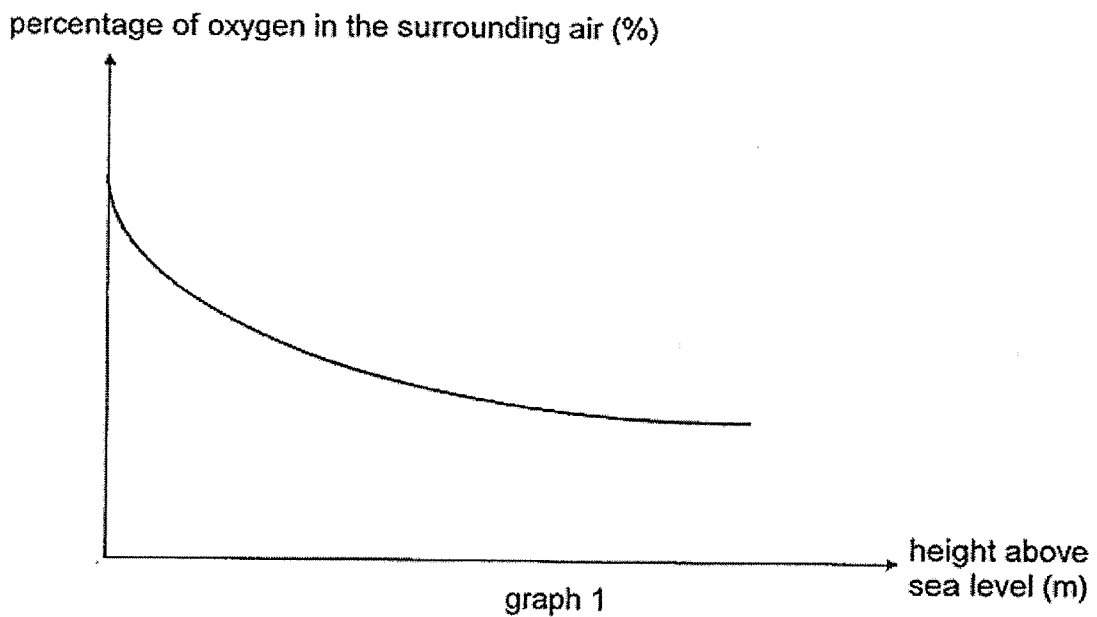

(a) Based on the results in graph 1, what is the relationship between the height above sea level and the percentage of oxygen in the surrounding air? [1]

---

---

Score	1
-------	---

(b)(i) Mr Gopal attempts to climb mountain K. Based on the results in graph 1, which line graph, X, Y or Z, in graph 2 shown below, correctly represents the change in Mr Gopal's breathing rate as he climbs up mountain K?

Tick the correct answer in one of the boxes provided.

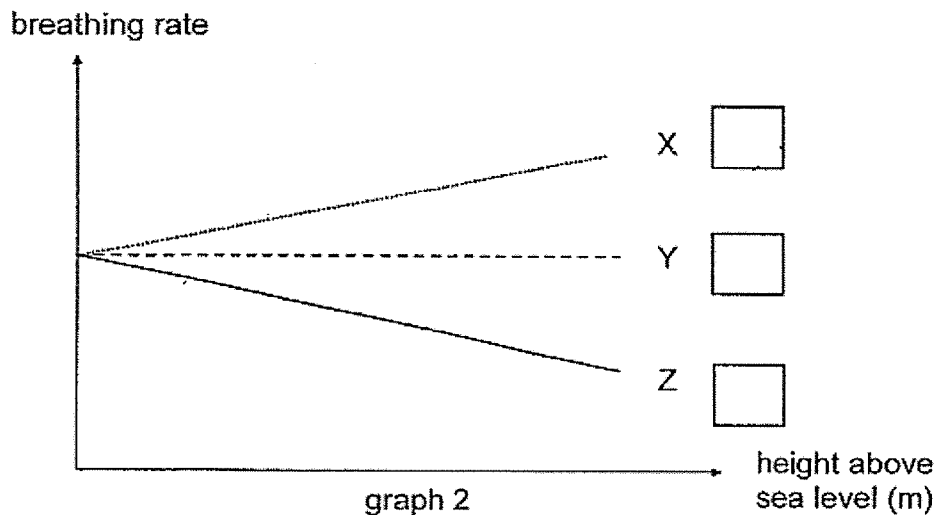

(b)(ii) Explain your choice in part (b)(i).

[2]

---



---



---

The table below shows Mr Gopal's heart rates at rest, when he is at different heights above sea level.

Location	Heart rate (beats per min)
Top of the mountain K	80
Bottom of the mountain K	70

(c) Explain why Mr Gopal's heart rate is faster when he is at the top of the mountain K. [1]

---



---

Score	3
-------	---

34. Michael was snowboarding on the top of a snow mountain. Mist was seen near his mouth whenever he breathed out as shown below.



- (a) Explain how the mist was formed. [2]

---

---

---

On his way home, Michael noticed that there was snow on his pants. After some time, the snow disappeared and his pants was wet.

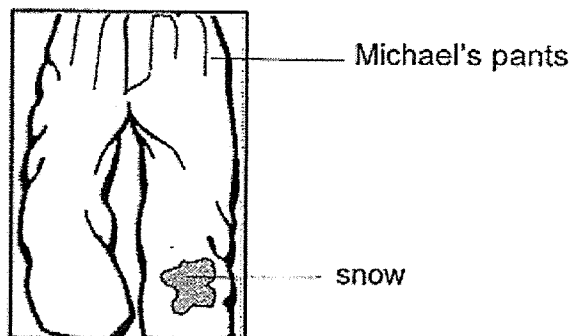

- (b) State the process that explains why his pants was wet when the snow on his pants disappeared. [1]

---

Score	3
-------	---

35. The diagram below shows how the volume of a rock can be measured using a displacement can.

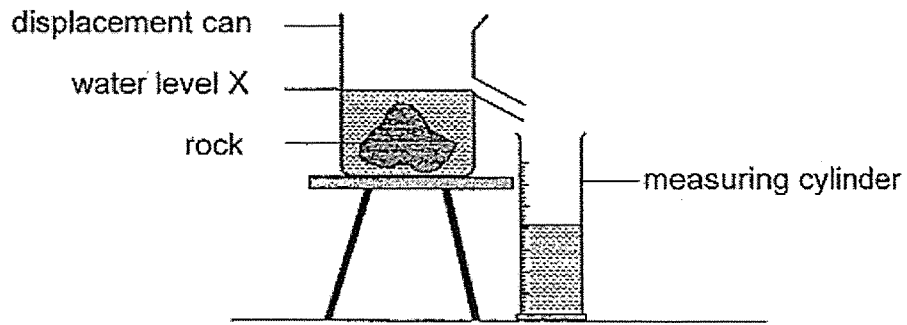

- (a) Arrange the following experimental steps in order by writing 1, 2, 3 and 4 in the boxes provided below for the above experiment. [1]

Measure the amount of water collected in the measuring cylinder.	
Lower the rock slowly into the displacement can.	
Pour water into the displacement can until the water reaches level X.	
Allow the displaced water to flow into the measuring cylinder.	

A water tank used for flushing a toilet bowl is shown below.

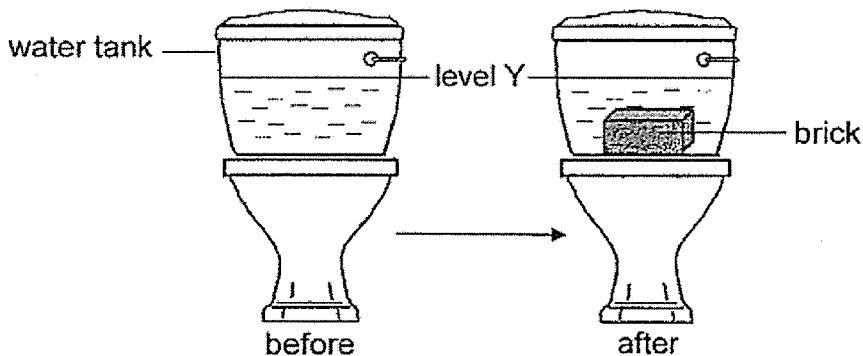

After flushing, water re-fills the water tank until the water reaches level Y. In order to conserve water, Ali put a block of brick into the water tank.

- (b) Explain how Ali's action would help to reduce the amount of water used to flush the toilet bowl. [1]

---



---

Score	2
-------	---

36. Two poles of the same height, P and Q, were placed on the stage for a shadow performance. Diagram 1 below shows the top view of the stage, positions of the two poles and the audience.

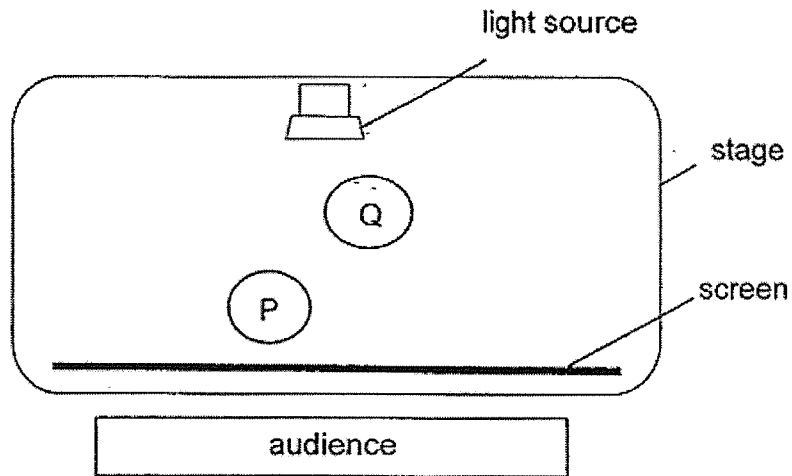

diagram 1

- (a) Which pole, P or Q, will form a bigger shadow? Explain your answer. [1]

---

---

Score	1
-------	---



Two dancers, X and Y, who were of different heights, were dancing on the stage for a shadow performance. Diagram 2 below shows the top view of the stage, positions of the two dancers and the audience.

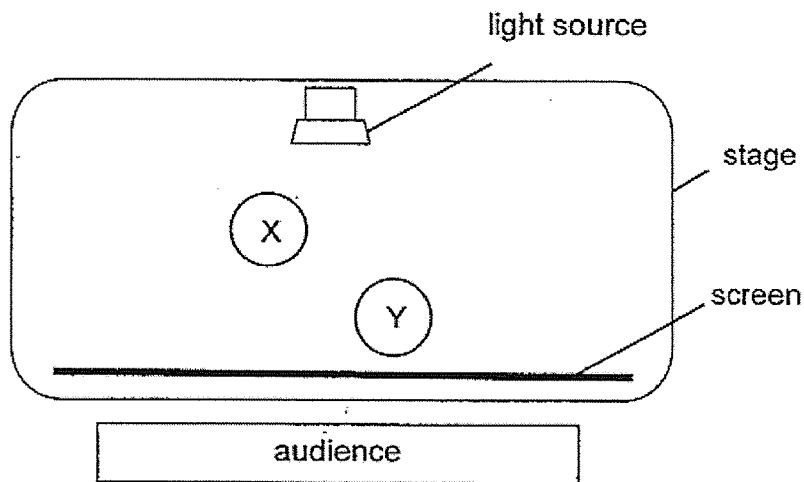
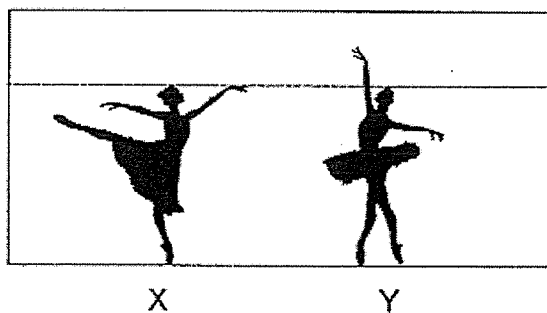

diagram 2

The diagram below shows the shadows of the dancers seen on the screen.



(b) Which dancer, X or Y, is taller? Explain your answer. [2]

---



---



---

Score	2
-------	---

37. The diagram shows Mr Tan rolling a bowling ball along the lane to knock down some pins.

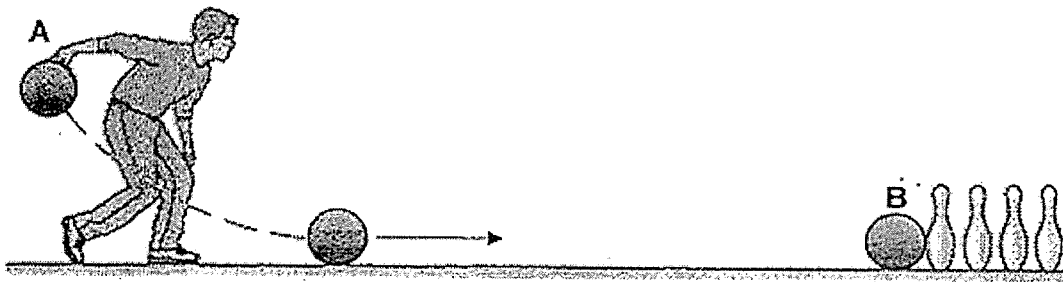

- (a) State the effect of forces on the pins when the bowling ball hits the pins at B. [1]

---

- (b) Identify the force needed to help Mr Tan grip the bowling ball at A. [1]

---

After some time, Mr Tan's hands became sweaty. He wiped his hands with a dry cloth to absorb the sweat before he rolled the bowling ball forward.

- (c) Explain how the sweat affects his grip on the bowling ball. [1]

---

---

Score	3
-------	---

38. The diagram below shows two plates made of different materials, A and B, with  $10 \text{ cm}^3$  of water each, placed in the sun.

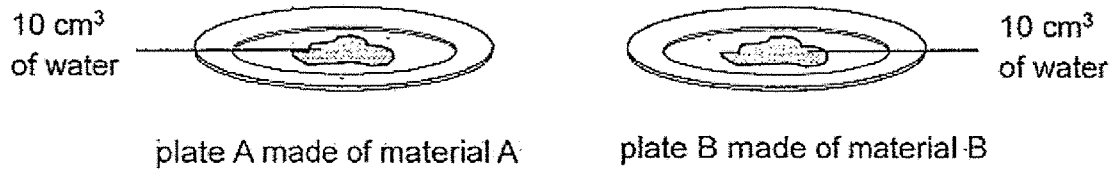

The results are shown in the table below.

Plate	Time taken for water to evaporate completely (min)
A	30
B	45

- (a) How can the above results for the experiment be made more reliable? [1]

---



---

The diagram below shows two containers made of materials A and B.



- (b) Based on the results in the table above, which container, A or B, should be used to keep food warm for a longer time? Explain your answer. [2]

---



---



---

Score	3
-------	---

39. Suresh performed an experiment on springs P and Q, of the same length, using the set-up shown below.

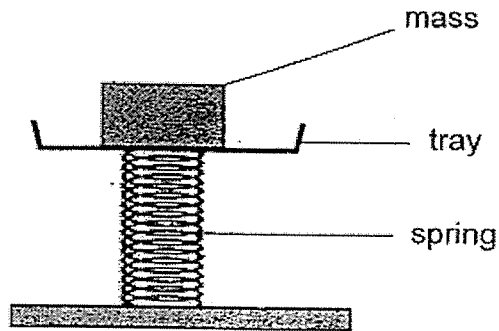

diagram 1

He measured the compression of each spring for different masses.

His results are shown in the table below.

Mass (kg)	Compression of spring P (cm)	Compression of spring Q (cm)
5	2.9	1.9
10	6.1	4.0
15	9.0	5.9
20	12.1	8.1

Diagram 2 below shows Suresh sitting on a rocking horse using spring Q.

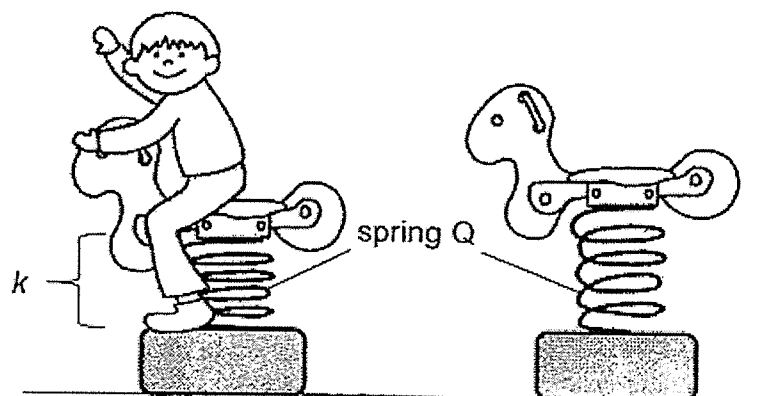

diagram 2

(a) Identify the force(s) acting on Suresh as he sat on the rocking horse. [1]

---

(b) After Suresh alighted from the rocking horse, spring Q returned to its original length as shown in the diagram 2. Explain the change in length of spring Q in terms of forces. [1]

---

---

One day, a technician carelessly replaced spring Q with spring P in the rocking horse.

(c) Based on the results in the table, would the height of spring P be more or less than  $k$  when Suresh sat on the rocking horse again? Explain your answer. [1]

---

---

Score	3
-------	---

40. Mei Li conducted an experiment as shown below.

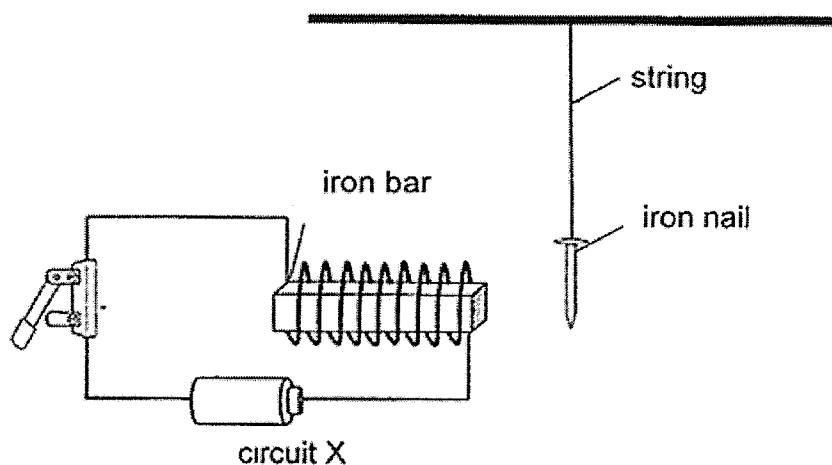

(a) Describe what Mei Li would observe when she closed the switch in circuit X.  
Explain her observation. [2]

---

---

---

Score	2
-------	---

Mei Li added circuit Y to the experiment using similar batteries, wires and switches as shown below. The iron nail was suspended between the two similar iron bars A and B.

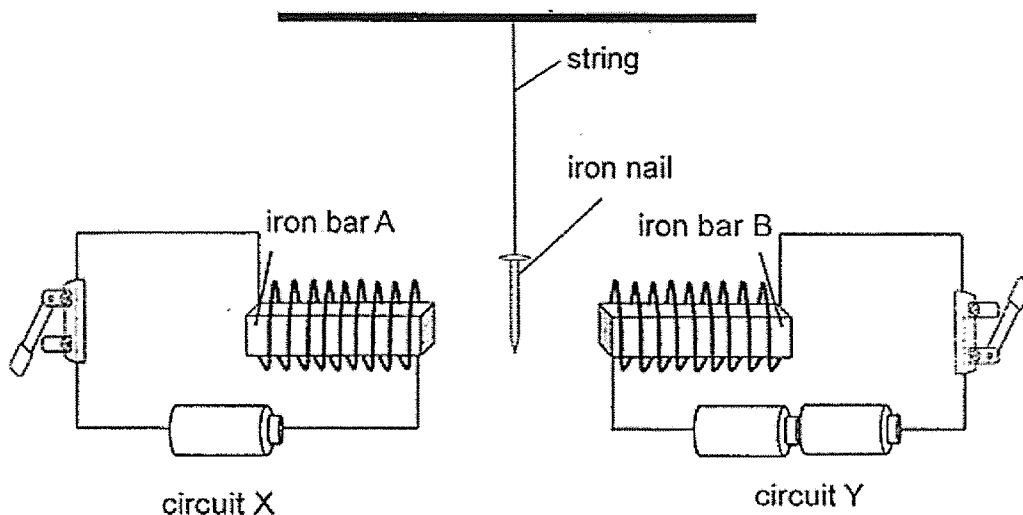

Mei Li observed that the iron nail was attracted to iron bar B when both switches in circuit X and Y were closed.

- (b) Without changing the number of batteries or iron nail, suggest two ways Mei Li could do to the above set-up so that the iron nail is attracted to iron bar A instead. [2]

---



---



---



---

- (c) Mei Li replaced the iron nail with a heavier iron nail. She observed that the nail did not move at all when the switches are closed. Explain her observation in terms of forces. [1]

---



---

Score	3
-------	---

41. The diagram shows a toy airplane.

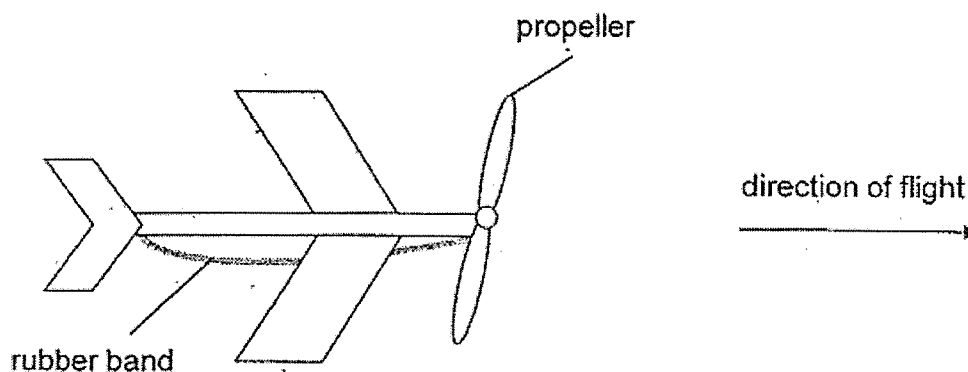

When the propeller is turned twenty times, it twists the rubber band connected to it. As the propeller is released, the rubber band unwinds, enabling the airplane to fly.

(a) Fill in the boxes to show the energy changes in the toy airplane. [1]

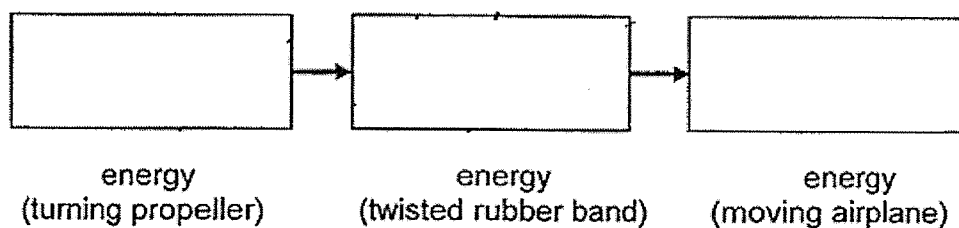

(b) Using the same toy airplane another experiment is conducted using two rubber bands. How would the distance travelled by the airplane be affected when two rubber bands are used instead? [1]

(c) When carrying out the experiment for (b), what are two other variables that need to be kept constant for the test to be fair? [2]

---

---

---

End of Paper

Score	4
-------	---



SCHOOL : TAO NAN PRIMARY SCHOOL  
LEVEL : PRIMARY 6  
SUBJECT : SCIENCE  
TERM : 2020 PERLIM

---

**SECTION A**

Q 1	Q2	Q3	Q4	Q5	Q6	Q7	Q8	Q9	Q10
2	4	4	4	3	1	4	4	3	3
Q 11	Q12	Q13	Q14	Q15	Q16	Q17	Q18	Q19	Q20
4	3	2	4	3	2	1	3	2	4
Q 21	Q22	Q23	Q24	Q25	Q26	Q27	Q28		
1	2	4	4	3	2	3	3		

	Suggested Answers
29a	Water / moisture/ dampness/ moist/ wetness/wet condition/wet (is needed for germination to take place).
29b	The germinating seeds <u>take in / need oxygen/respire</u> (giving out carbon dioxide which would be absorbed by substance X)  so the <u>volume</u> of air inside the test tube <u>decreased</u> ./there would be <u>less air occupying the space</u> in the test-tube.
30a	She should use a weighing machine/(weighing) scale
30b	The tiny insects fed on/ate/damaged the food-carrying tubes so no/insufficient food was transported to the roots./ the roots cannot receive food.
31a	Tick the flowers on the right
31b	To feed on the nectar/obtain food from the flowers
31c	Bird A/B picked up the pollen grains (from the anther) or Pollen grains were stuck/stick/cling on/ brushed on the feather/bird dropping off pollen grains onto a stigma.
32a	i) Add 20 ml of water to the soil.  ii) Introduce air into the container
32b	The <u>rate of photosynthesis</u> of the water plant <u>increases</u> / the water plant <u>photosynthesises faster</u> / the water plant <u>absorbs more light for photosynthesis</u> / the water plant <u>make more food</u> (cause) so <u>more oxygen is produced</u> / <u>oxygen is produced faster</u> . (effect)
32c	This is to ensure that no other source of light would affect the results / the time taken for 50 bubbles to be produced- <i>link incorrect variable to results</i> OR This is to ensure that the lamp is the only source of light that would affect the results/ the time taken for 50 bubbles to be produced. - <i>link correct variable to results</i>
32d	She should place a (lit) lamp near/ above/beside the water plants in the aquarium. Move the aquarium beside/near a window with sunlight. Put the aquarium at a location with higher light intensity.

33a	As the <u>height</u> above sea level increases (cause), the ( <u>percentage of</u> ) <u>oxygen</u> in the surrounding air decreases (effect). or As the <u>height</u> above sea level decreases (cause), the ( <u>percentage</u> ) of <u>oxygen</u> in the surrounding air increases (effect).
33b	<u>Moving up the mountain, there is less oxygen (cause) so Mr Gopal will breathe faster/ more times/ breathing rate increases to take in sufficient /same/ enough/ more oxygen (effect).</u>
33c	Mr Gopal's heart pumps faster so that <u>blood with oxygen moves faster to body parts/ oxygen reaches faster to the body parts/enough oxygen is sent to body parts.</u>
34a	The water vapour from his breath/mouth/him comes into contact with the cooler surrounding air and condensed. or The warmer water vapour from this breath comes into contact into the surrounding air lost heat to form water droplets.
34b	Melting
35a	4, 2, 1, 3
35b	The brick takes up space (in the water tank) so less water is needed to refill the tank. or The brick has fixed volume (in the water tank) so less water is needed to reach Y.
36a	Pole Q as it is <u>nearer to the light source / further from the screen.</u>
36b	Y is taller. Y is further from the light source /nearer the screen but the shadows are of the same height/size.
37a	The pins/object moved/ fell/ dropped/toppled.
37b	Friction/frictional force
37c	The sweat (is a lubricant which) <u>reduces / decreases frictional force / friction between his hand and the bowling ball (cause) so the grip is weakened/ may drop the ball (effect)</u>
38a	Repeat the experiment several times/ more times / take more readings

38b	<p>Food container B (claim)</p> <p>Material B takes a longer time for the water to evaporate completely. (evidence from experiment) Therefore material B is a poorer conductor of heat (property)/ material B conducts heat slower from the surroundings to the water (still on reference to experiment)</p> <p>and food container B <u>will conduct heat away from the warm food to the surroundings slower.</u> (approach from container) / food will lose less heat to the surroundings (approach from food)/ and food will lose heat slower to the surroundings (approach from food) - 3Application</p>
39a	<p>Any two: gravitational force, frictional force, elastic spring force</p>
39b	<p><u>Less weight</u> (of Suresh)/ no weight acting on the <u>spring</u>.</p> <p><u>Less/ no gravitational force</u> (of Suresh) acting <u>on the spring</u>.</p>
39c	<p>The height of spring P would be less than K as <u>spring P compresses more when the same mass is hung on them</u> /<u>spring P is less stiff</u>.</p>
40a	<p>The <u>iron nail is attracted to the iron bar as iron is a magnetic material</u>. When the switch is closed, <u>a closed circuit is formed/electricity flows through the circuit</u> and the <u>iron bar turned into an electromagnet/ is magnetised</u>.</p>
40b	<p>Add more coils of wire around iron bar A/ Open the switch in circuit Y/Shift circuit Y to the right/ Shift circuit X nearer to the nail. / Move the string of the nail closer to X</p>
40c	<p>Magnetic force is not strong enough (to attract the iron nail.)</p>
41a	<p>kinetic energy → (elastic) potential energy → kinetic energy</p>
41b	<p>The distance travelled by the airplane will be <u>further / longer/greater/more</u>.</p>
41c	<p><i>Any two of these:</i> How the toy airplane is released. Height the toy airplane is released. Speed of wind/ Presence of wind Number of times the propeller is turned Direction of flight Accept anything pertaining to rubber band</p>