

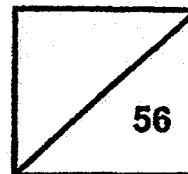

Rosyth School
Preliminary Examination 2019
SCIENCE
Primary 6

Name: _____

Total
Marks:



Class: Pr 6- _____

Total time for
Booklets A and B: 1 h 45 min

Date: 29 August 2019

Booklet A

Instructions to Pupils:

1. Do not open the booklet until you are told to do so.
2. Follow all instructions carefully.
3. This paper consists of 2 booklets, Booklet A and Booklet B.
4. For questions 1 to 28 in Booklet A, shade the correct ovals on the Optical Answer Sheet (OAS) provided using a 2B pencil.

* This booklet consists of 22 printed pages (including cover page).

For each question from 1 to 28, four options are given. One of them is the correct answer. Make your choice (1, 2, 3 or 4). **Shade the correct oval (1, 2, 3 or 4) on the Optical Answer Sheet.** [56 Marks]

1 Which one of the following characteristics can be used to differentiate between a reptile and a bird?

- (1) The way they breathe
- (2) The way they reproduce
- (3) The number of body parts
- (4) The type of outer covering

2 Study the classification chart below.

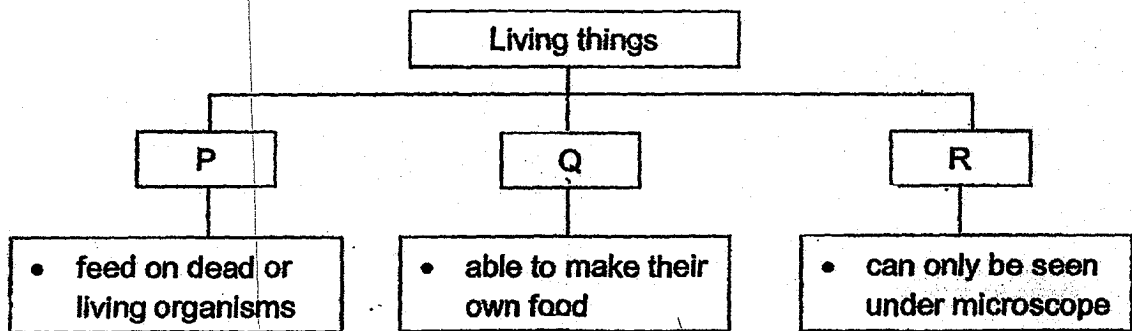

Which one of the following headings do P, Q and R represent?

	P	Q	R
(1)	fungi	bacteria	non-flowering plants
(2)	fungi	flowering plants	bacteria
(3)	plants	decomposers	bacteria
(4)	decomposers	flowering plants	fungi

3 Study the plant cell shown below.

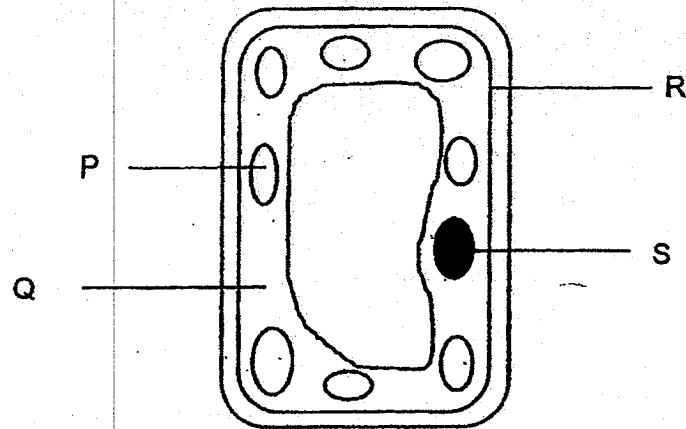

Where does photosynthesis take place inside the plant cell?

- (1) P
- (2) Q
- (3) R
- (4) S

4 Study the life cycle shown below.

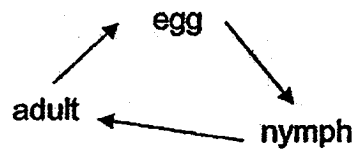

Which one of the following animals has a life cycle similar to the one shown above?

- (1) frog
- (2) chicken
- (3) mosquito
- (4) grasshopper

5 David studied the graph below.

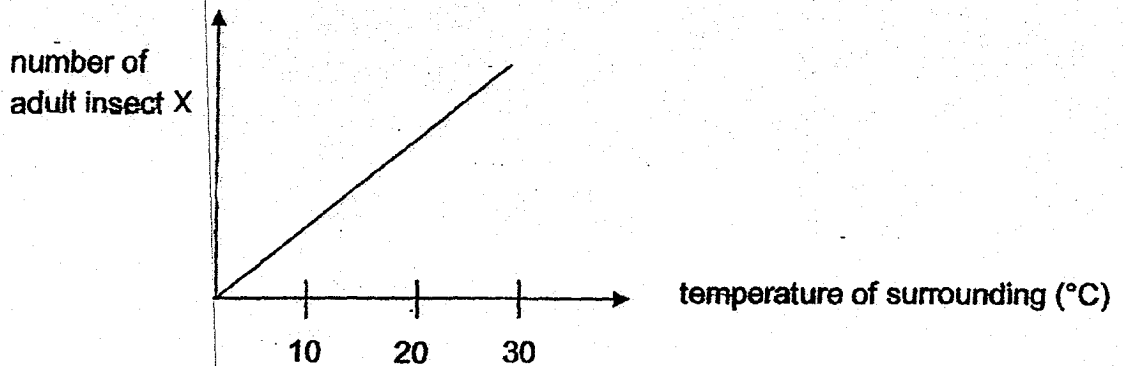

The graph shows the relationship between the surrounding temperature and the number of adult insect X in a farm.

David stated two reasons to explain the relationship as shown in the graph:

- A As the surrounding temperature increases, the number of eggs laid by insect X increases.
- B As the surrounding temperature increases, the number of days to complete the life cycle of insect X decreases.

Based on the graph, which reason(s) is/are possible?

- (1) A only
- (2) B only
- (3) A and B
- (4) Neither A and B

6 The diagram below shows the developmental stages of a flowering plant.

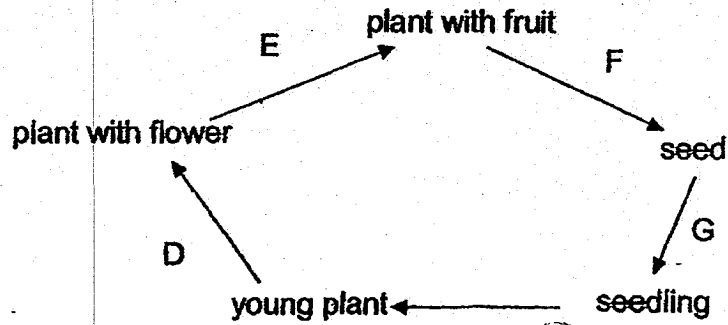

Where do the processes of pollination, fertilisation and germination take place?

	Pollination	Fertilisation	Germination
(1)	E	E	G
(2)	D	E	G
(3)	E	E	F
(4)	D	F	G

- 7 Seaweeds are plants that live in the sea. An example of a seaweed is shown below.

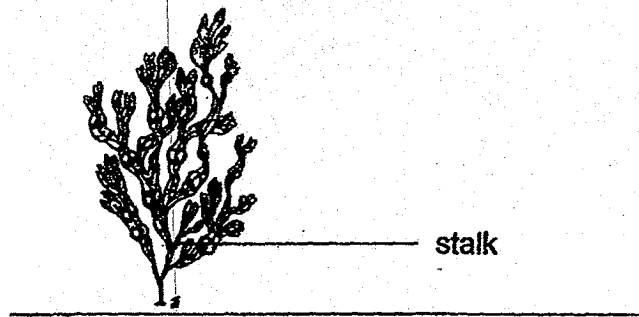

Waves pull the seaweed in different directions and the seaweed is adapted to survive the sea waves.

Which properties of the stalk have helped it to adapt in its environment?

- (1) Elastic and Flexible
 - (2) Flexible and Strong
 - (3) Elastic and Strong
 - (4) Elastic and Waterproof
- 8 Which one of the following groups shows a population in a habitat?
- (1) adults of animal A, adult plants
 - (2) young plants, adult plants, plant-eaters
 - (3) eggs of animal A, larvae of animal B, adults of animal C
 - (4) eggs of animal X, larvae of animal X, adults of animal X

- 9 The diagrams below show the healthy and the infected gills. The infected gills have fungi S growing into them.

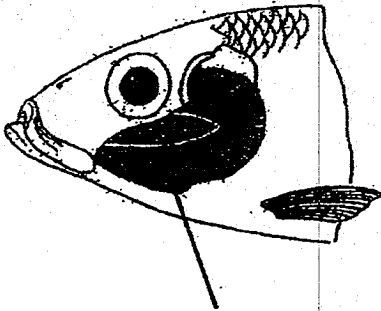

healthy gills

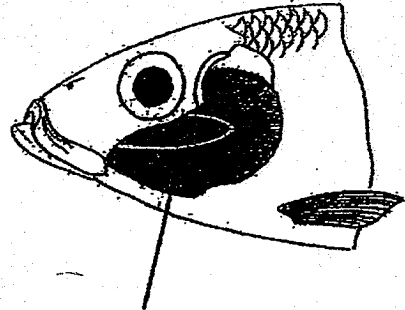

fungi S growing into the gills

Based on the above information, which one of the following graphs correctly shows the effect of fungi S on the amount of oxygen absorbed into the bloodstream of the fish?

- (1) Amount of oxygen absorbed (ml)

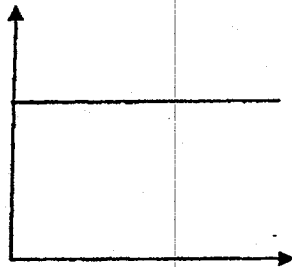

Amount of fungi S

- (2) Amount of oxygen absorbed (ml)

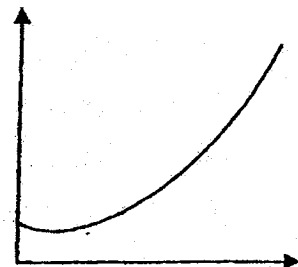

Amount of fungi S

- (3) Amount of oxygen absorbed (ml)

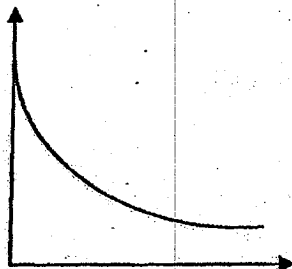

Amount of fungi S

- (4) Amount of oxygen absorbed (ml)

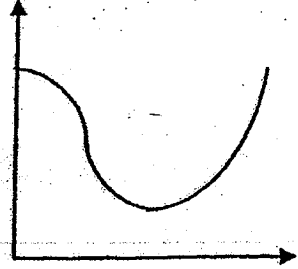

Amount of fungi S

10 Amanda carried out an experiment using the set-ups as shown below.

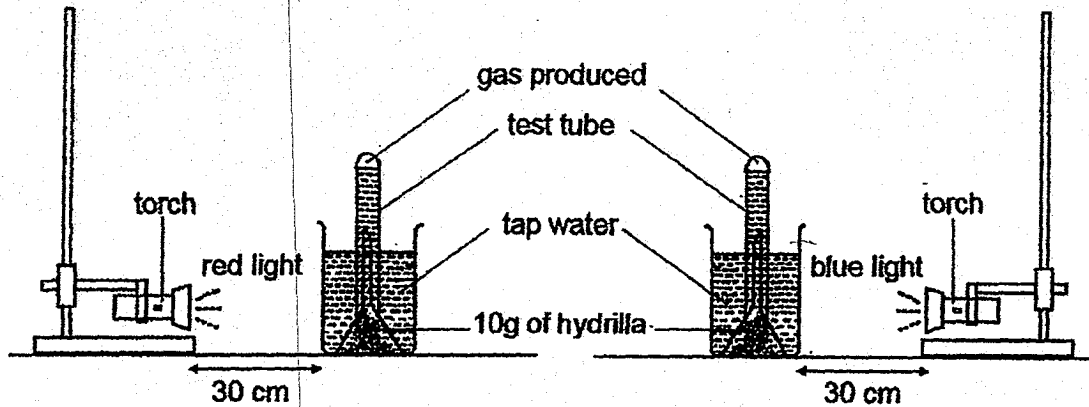

Amanda kept the torch and the distance of the torch from the hydrilla the same to ensure a fair test.
 What could she change in the above set-up to increase the amount of gas produced?

- (1) Use pond water.
- (2) Use green light.
- (3) Use 20g of hydrilla.
- (4) Use bigger beakers.

11 The diagram below shows a part of the circulatory system of a fish. The arrows represent the movement of blood in a fish.

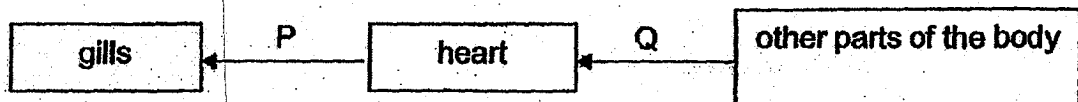

circulatory system of a fish

The blood flowing through _____.

- (1) P and Q are rich in oxygen
- (2) P and Q are rich in carbon dioxide
- (3) P is rich in oxygen while Q is poor in oxygen
- (4) P is poor in oxygen while Q is rich in oxygen

- 12 Four plants were placed into identical jars, each containing the same level of water at first. They were then left near a window for an hour. The height 'h' in each jar was measured at the end of the experiment.

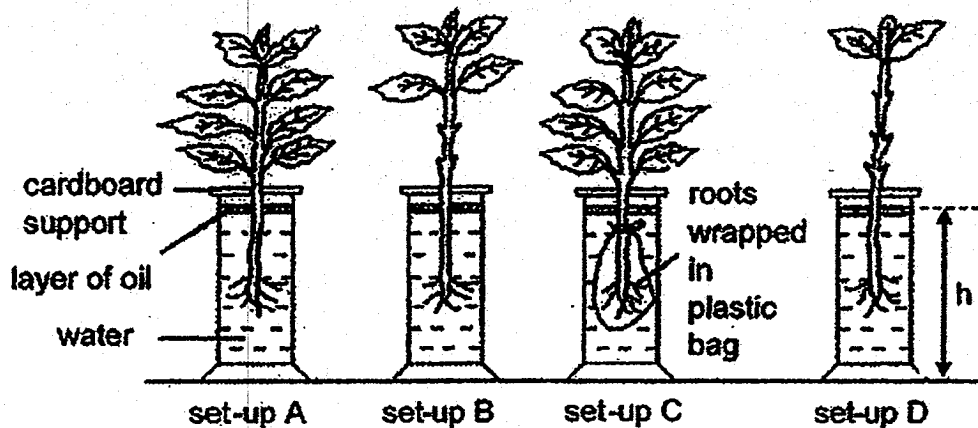

Which one of the following correctly shows the height 'h' from the greatest to the smallest?

- (1) B, A, D, C
- (2) B, A, C, D
- (3) C, D, A, B
- (4) C, D, B, A

- 13 Study the food chain below.

Z → X → Y → W

Which one of the following is correct?

	Population size	Effect
(1)	Z increases.	X, Y and W will decrease.
(2)	Z decreases.	X, Y and W will decrease.
(3)	W increases.	X, Y and Z will decrease.
(4)	W decreases.	X, Y and Z will increase.

- 14 A scientist carried out an investigation to find out how the amount of dissolved oxygen in water will affect the number of two types of organisms.

Types of organism	Represented by
10 organism A	△
10 organism B	□

The organisms were placed in two different containers of water. The water in each containers had different amount of dissolved oxygen.

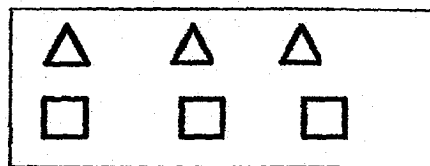
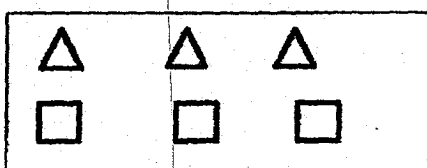

Based on results, he concluded that organism A is not affected by the amount of dissolved oxygen in water while organism B is affected by the amount of dissolved oxygen in water.

Which one of the following shows a possible result for his conclusion?

	More amount of dissolved oxygen in water than normal	Less amount of dissolved oxygen in water than normal
(1)		
(2)		
(3)		
(4)		

15 Which one of the following is a good conductor of heat?

- (1) metal
- (2) wood
- (3) fabric
- (4) plastic

16 Three bars were freely suspended on a rod as shown in the diagram below.

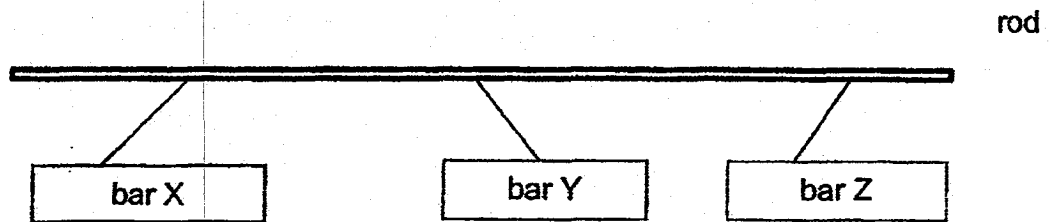

Based on the above observation, which bars are definitely magnets?

- (1) X and Y only
- (2) Y and Z only
- (3) X and Z only
- (4) X, Y and Z

17 The picture below shows a tree and its reflection in the water.

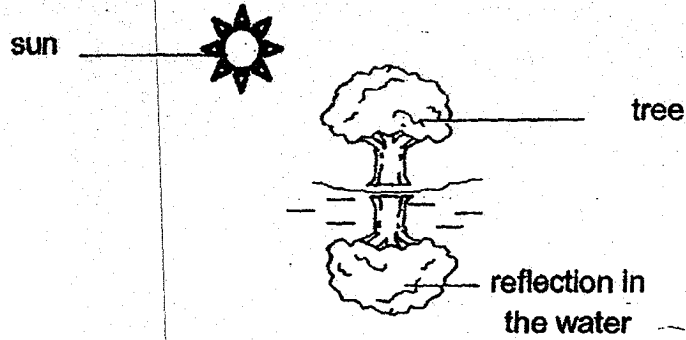

Which one of the following correctly shows the path of light for the reflection of the tree in the water to be seen?

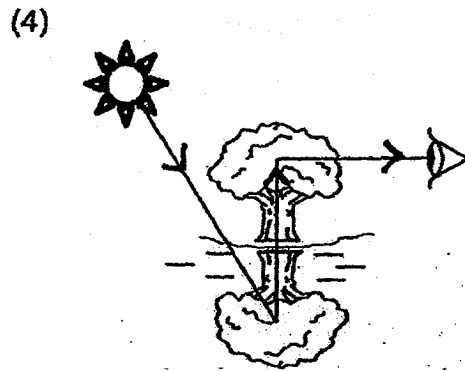
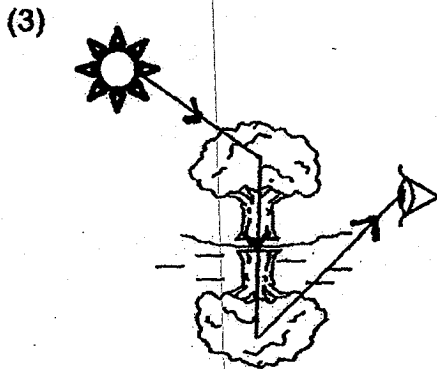
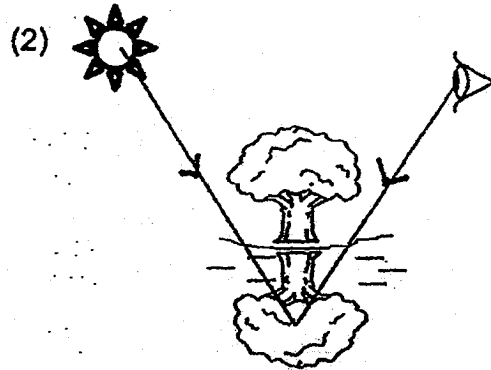
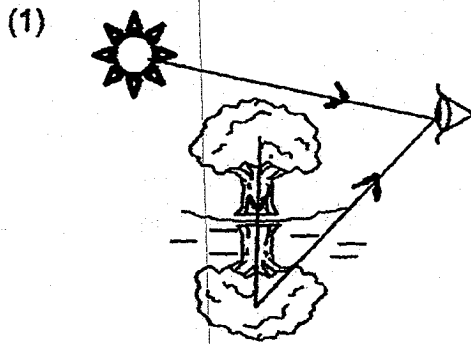

- 18 Victor wanted to find out if the number of pieces of paper would affect the amount of light that could pass through it. He set up an experiment as shown below.

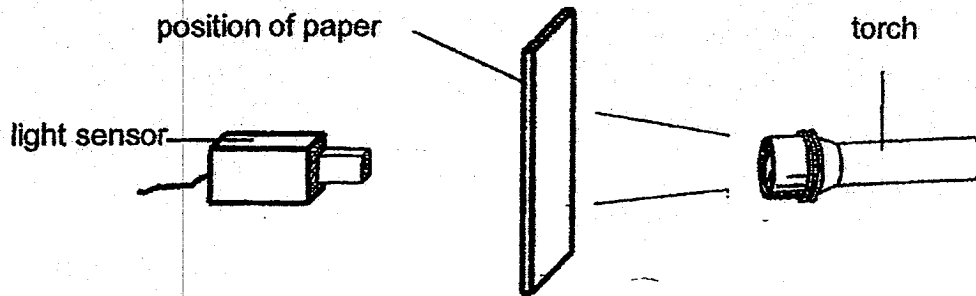

He increased the number of pieces of paper and recorded the amount of light that passed through in the table below.

Number of pieces of paper	Amount of light detected (units)
0	48
2	33
4	24
6	12
8	0
10	0

Based on the information Victor collected, which one of the following is definitely true?

- (1) The amount of light blocked by six pieces of paper was 12 units.
- (2) The amount of light detected for one piece of paper would be 40 units.
- (3) The amount of light detected for nine pieces of paper would be 0 units.
- (4) The amount of light blocked by seven pieces of paper would be 48 units.

19 Air is pumped into the balloon as shown below using an air pump.

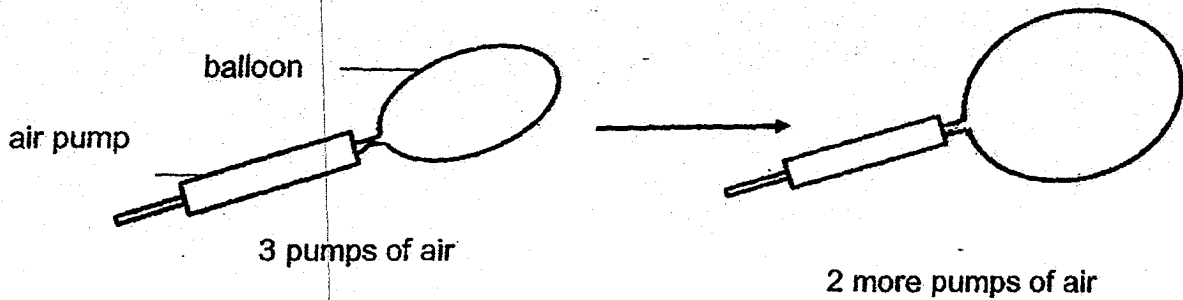

What happens to the total volume and the mass of air in the balloon after 2 more pumps of air is given?

	Total volume of air in the balloon	Total mass of air in the balloon
(1)	increases	increases
(2)	remains the same	increases
(3)	remains the same	remains the same
(4)	increases	remains the same

20 Two identical containers, A and B, were covered with identical lids. Container A was filled with 250g of ice cubes and Container B was filled with 250g of water at room temperature. They were placed on a balance as shown below.

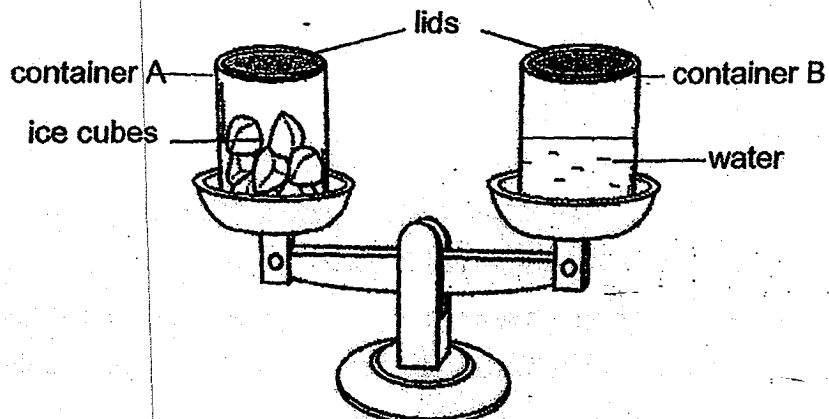

After ten minutes, the balance tilted downwards on the side of container A. Which one of the following could be the reason for this observation?

- (1) The ice cubes in container A had melted.
- (2) The water in container B had evaporated.
- (3) Water droplets were formed on the outer surface of container B.
- (4) Water droplets were formed on the outer surface of container A.

21 Susan was given two syringes covered with black paper. Syringe A contained substance S while syringe B contained substance T. The distance d before pushing was kept at 10 cm. She pushed the plungers and measured the distance ' d ' as shown below.

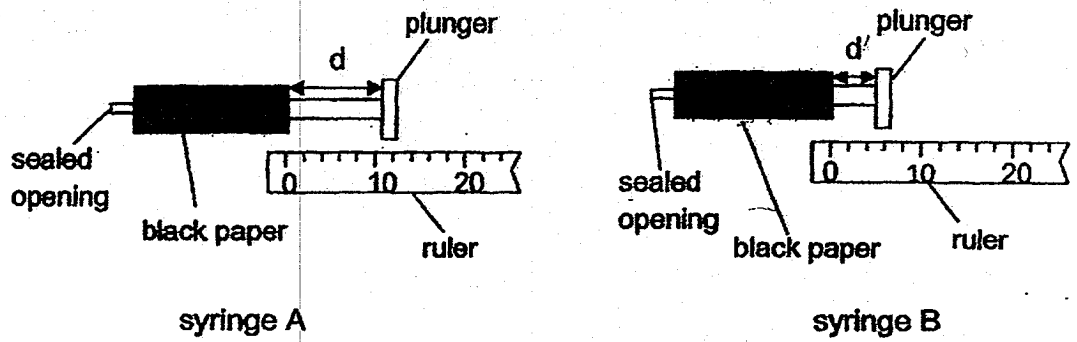

She recorded her results in the table below.

	d (cm)	
	Before pushing	After pushing
Substance S	10	10
Substance T	10	5

Which one of the following could be substances S and T?

	Substance S	Substance T
(1)	cotton wool	fruit juice
(2)	air	cotton wool
(3)	water	fruit juice
(4)	water	cotton wool

22 The diagram below shows a water cycle.

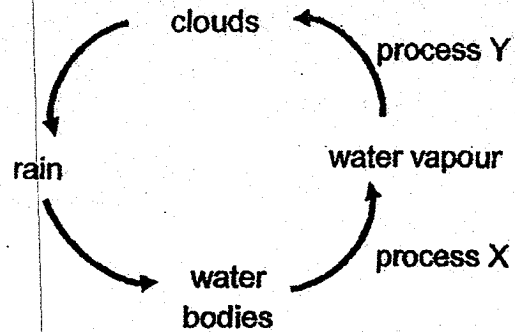

Which of the following statement is correct?

- (1) Process X occurs at a fixed temperature.
- (2) Process X occurs when water in waterbodies loses heat.
- (3) Process Y occurs when there is no temperature difference.
- (4) Process Y occurs when water vapour loses heat to surrounding air.

- 23 Lionel wanted to determine the effect of plants on the temperature of air in a room. He set up the experiment as shown below using ~~the~~ different coloured walls.

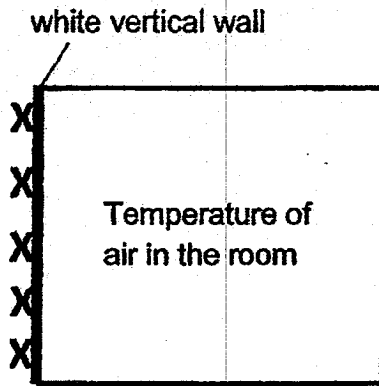

set- up A

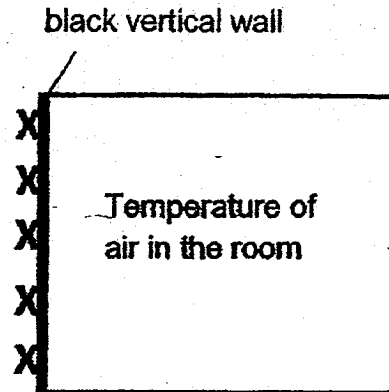

set- up B

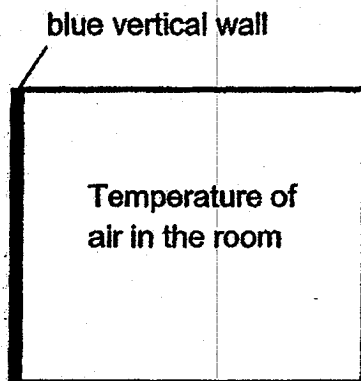

set- up C

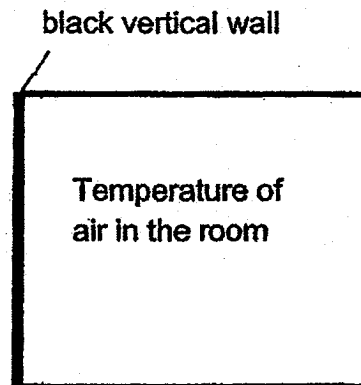

set-up D

X represents plants on the vertical wall.

Which two set-ups should he use in his experiment?

- (1) set-ups A and B only
- (2) set-ups A and D only
- (3) set-ups B and D only
- (4) set-ups C and D only

24 Weiling sets up a circuit as shown. All the bulbs and batteries are working properly.

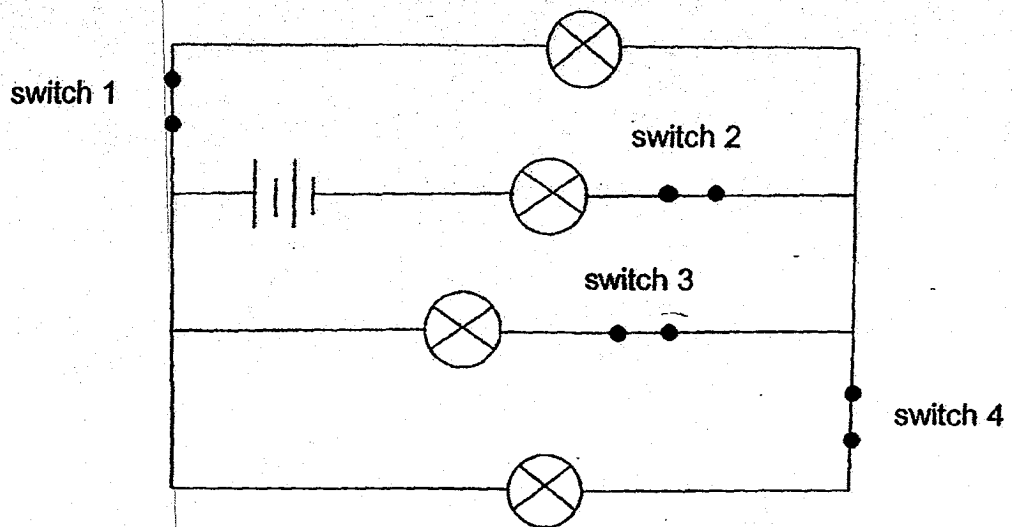

All four bulbs light up when all four switches are closed.
Which switch should she open if she wants none of the bulbs to light up?

- (1) Switch 1
- (2) Switch 2
- (3) Switch 3
- (4) Switch 4

25 Gopal set up bulb A in four different electrical circuits P, Q, R and S using identical batteries and identical bulbs. The batteries and bulbs are all working properly.

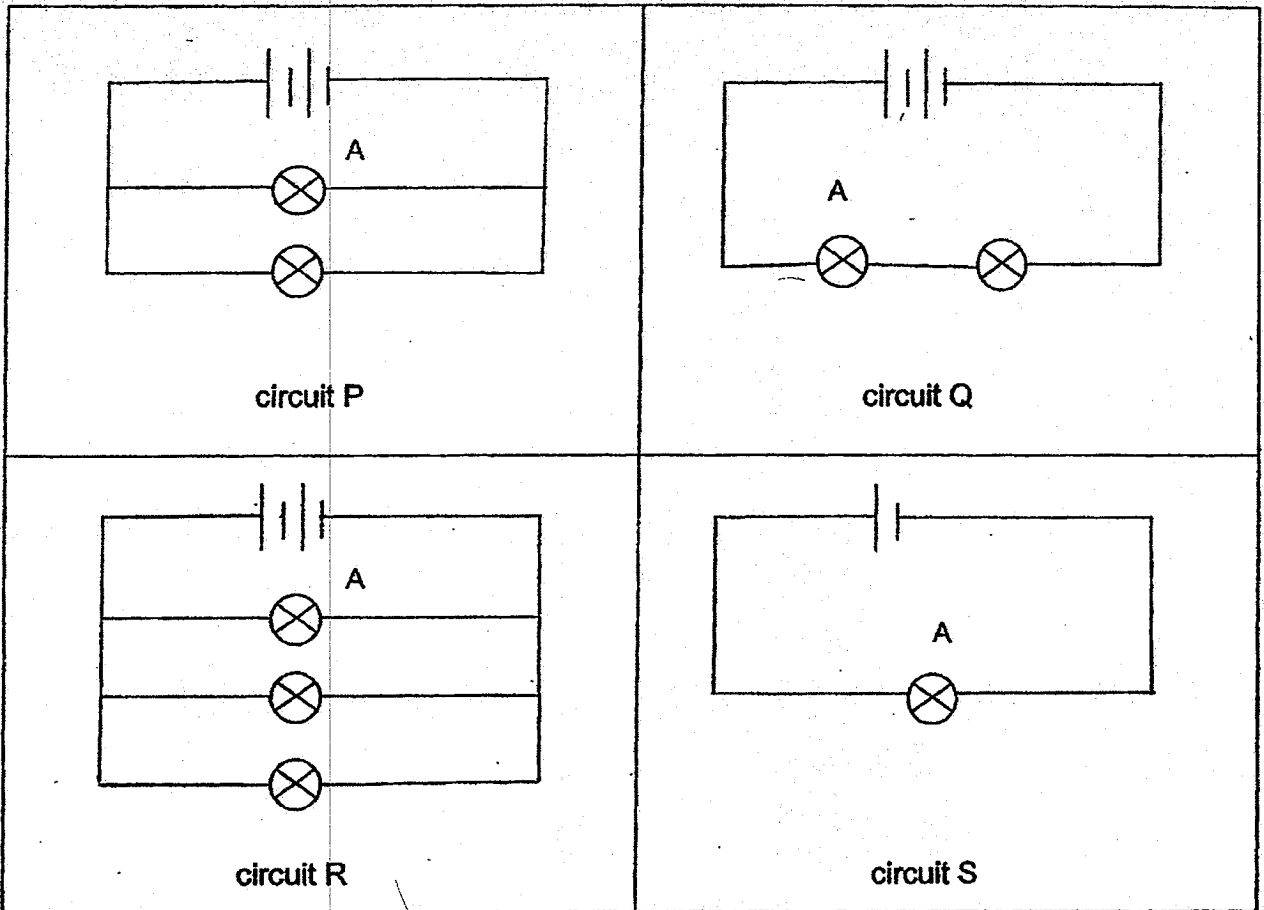

In which circuits would bulb A have the same brightness?

- (1) P and Q only
- (2) P and R only
- (3) P, R and S only
- (4) Q, R and S only

- 26 The diagram below shows the different positions of a bungee jumper who was secured by an elastic rope as he jumped off. At first, the bungee jumper was at the top, position P before he took his jump.

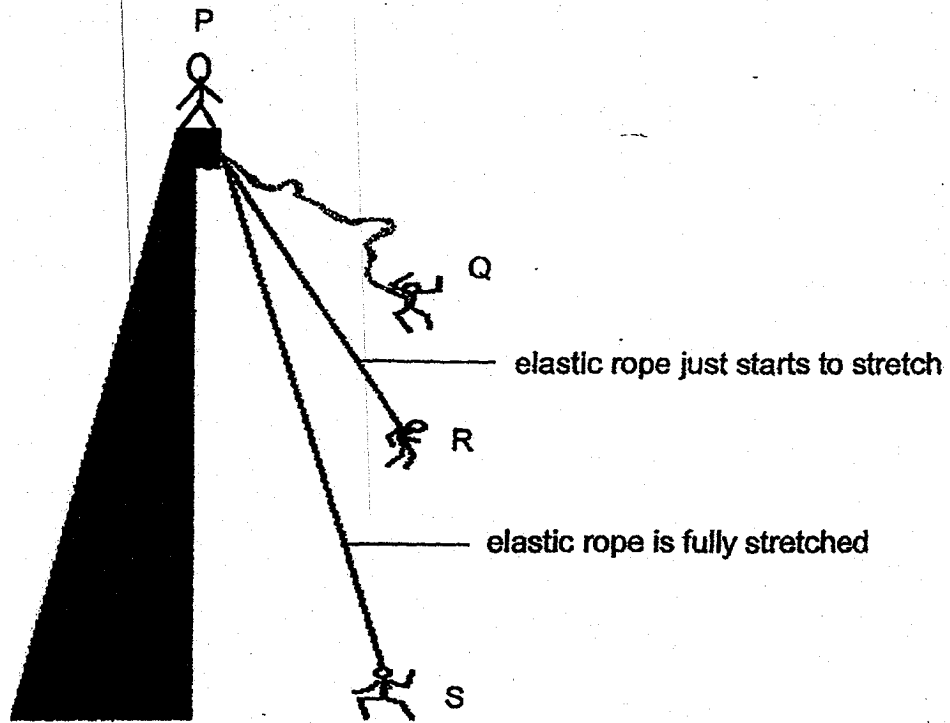

Which one of the following shows the correct conversion of energy as the bungee jumper jumps from position P to S?

- (1) potential energy (stretched rope) → kinetic energy (jumper) → potential energy (jumper)
- (2) potential energy (jumper) → potential energy (stretched rope) → kinetic energy (jumper)
- (3) kinetic energy (jumper) → kinetic energy (stretched rope) → potential energy (jumper)
- (4) potential energy (jumper) → kinetic energy (jumper) → potential energy (stretched rope)

- 27 The diagram below shows the path of object A after the strap has been pulled back and released using device C.

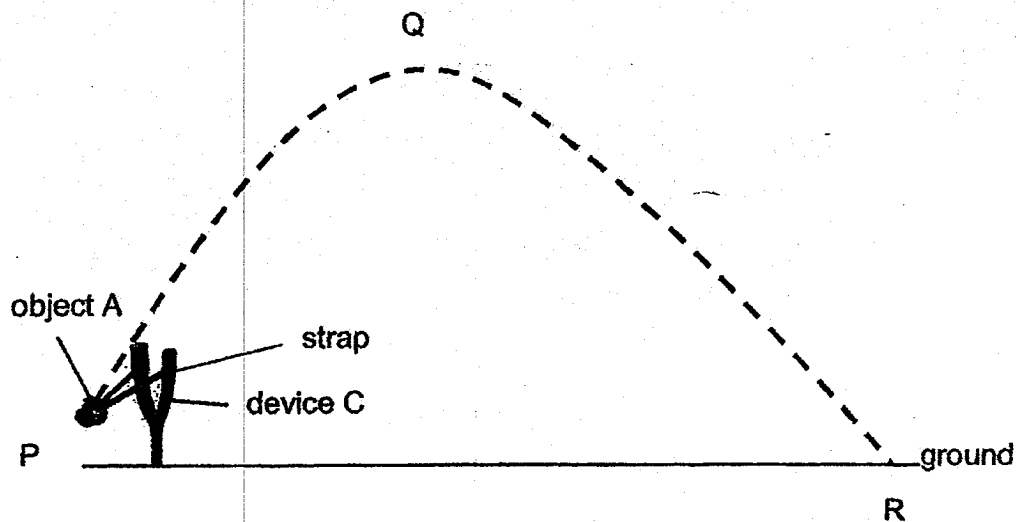

Which of the following statement(s) is/are true?

- A Gravity is acting on object A at point Q only.
- B The speed of object A decreases as it falls from Q to R.
- C A greater force is applied to the strap when it is pulled back further.
- D The kinetic energy of object A decreases while its gravitational potential energy increases as it moves from P to Q.

- (1) A only
- (2) D only
- (3) C and D only
- (4) B, C and D only

28 Two groups of people were in a tug-of-war as shown below.

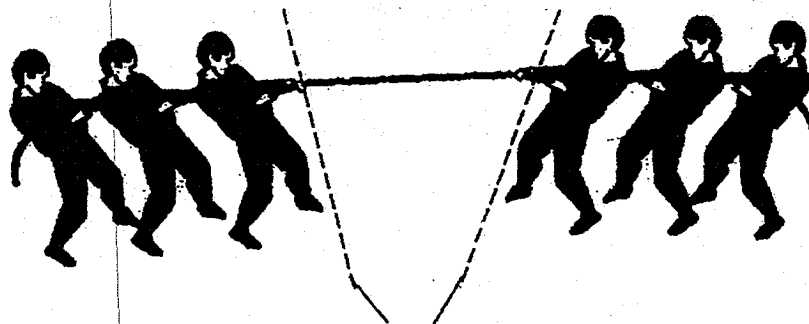

starting lines marked on the floor for each group

Neither of the groups was able to make the other group move to its side because _____.

- (1) the force they exerted was not great enough
- (2) the friction between their feet and the ground prevented it
- (3) each group exerted an equal and opposite force on the other group
- (4) the gravitational force was greater than the pulling force exerted by each group



Rosyth School
Preliminary Examination 2019
SCIENCE
Primary 6

Name: _____

Total
Marks:

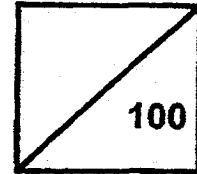

Class: Pr 6- _____

Total time for
Booklets A and B: 1 h 45 min

Date: 29 August 2019

Parent's Signature: _____

Booklet B

Instructions to Pupils:

For questions 29 to 40, write your answers in the spaces given in this booklet.

	Maximum	Marks Obtained
Booklet A	56 marks	
Booklet B	44 marks	
Total	100 marks	

* This booklet consists of 16 printed pages (including cover page).

For questions 29 to 40, write your answers in the space provided. **[44 Marks]**

29 Robert set up a glass tank. He put some plants and animals, X and Y, into the tank, added some water before it was sealed tightly. He then placed it at a brightly-lit room.

(a) Name the process that must take place in plants and the gas that is required for the animals to survive. **[2]**

Process: _____

Gas: _____

Robert observed that animal Y fed only on animal X. Animal X fed on the plants in the tank. He recorded the number of animals, X and Y, over time in the tank as shown in the table below.

Day	Number of animals	
	Animal X	Animal Y
1	20	5
20	8	2
120	25	5

(b) Based on the results above, give a reason for the change in number of animal Y between Day 1 to Day 20. **[1]**

(c) Explain why the number of animal X on Day 120 was higher than that on Day 20 although the number of animal Y had also increased. **[1]**

30 The diagram below shows animal K.

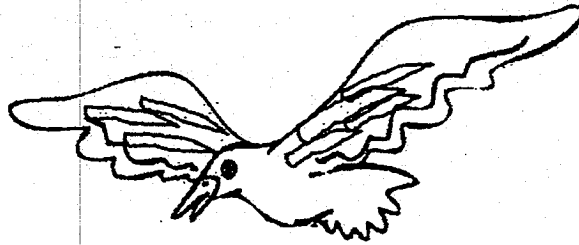

animal K

Animal K is found in country M that experiences short period of hot season and long period of cold season. It flies to country N during the period of cold season to look for food.

(a) Name two characteristics of living things that are shown by this behaviour of animal K. [2]

Characteristic 1: _____

Characteristic 2: _____

(b) Other than competing for food, suggest two possible ways in which animal K can be harmful to other animals living in country N. [1]

- 31 The diagram below shows the plant reproductive system.

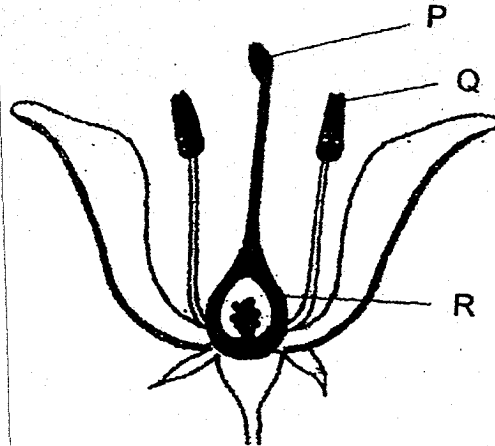

- (a) State the function of part P. [1]

- (b) Which part (P, Q or R) of the flower will develop into a fruit after fertilisation? State the function of a fruit. [1]

Scientists carried out an experiment with flowers from plant X and found out that within three minutes of exposure to the sound of bees, the flowers increased the amount of sugar in their nectar by twenty times.

- (c) Explain how the above behaviour of the flowers can benefit plant X. [1]

When the above experiment was carried out, the scientists had two groups of flowers. One group was exposed to the sound of bees while the other was exposed to some other sound.

- (d) Do you think the above is a necessary step to take? Explain why. [1]

32. A group of students conducted an experiment using two identical tubes as shown. They put the two set-ups, A and B, in the sun for a few hours.

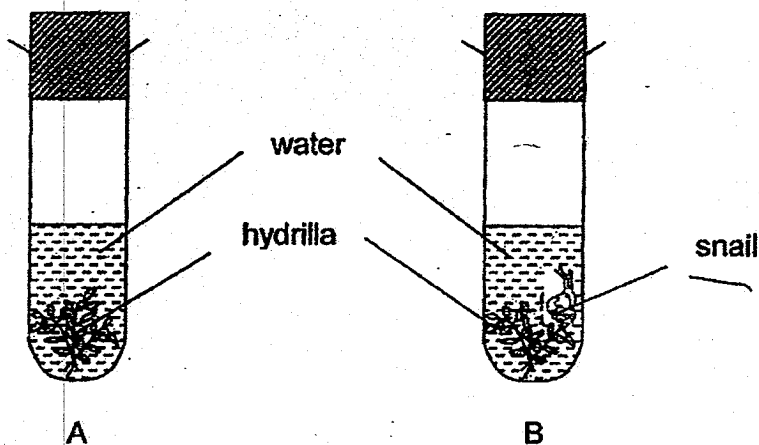

After a few hours, a drop of red indicator was added to each tube. When the red indicator was added, the colour of water changed according to the amount of carbon dioxide present.

The colour of water indicates the amount of carbon dioxide present as shown below.

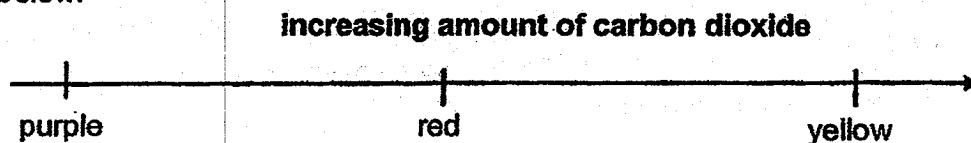

- (a) In which set-up would the colour of indicator more likely to turn purple?
Explain your choice of answer.

[1]

- (b) Other than what is observed from the experiment above, state one way in which animals benefit from plants in a pond.

[1]

- 33 Scientists studied a certain type of sea turtles. Sea turtles live in the sea but lay their eggs on the beaches.

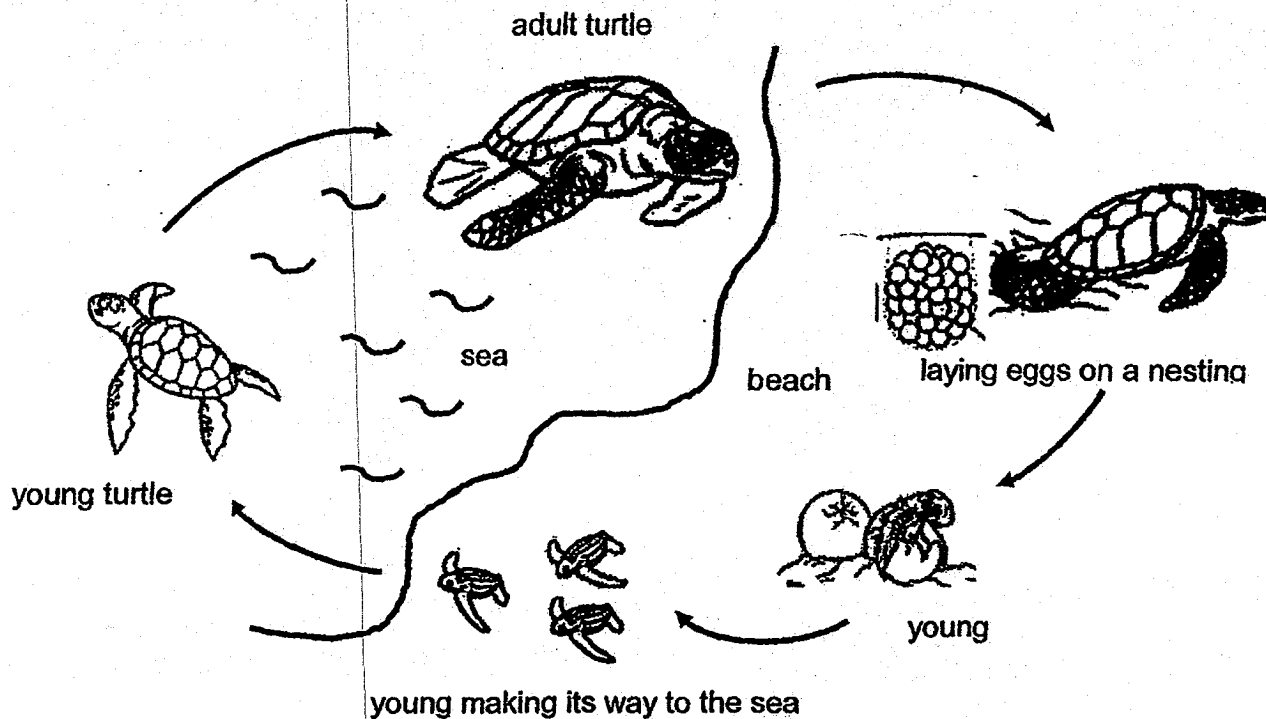

As the amount of carbon dioxide in the environment increases, it was observed that the nesting grounds of turtles were disappearing.

- (a) Explain how this happens. [2]

Question 33 is continued on page 7

Scientists have discovered that the incubation temperature of the eggs determines the gender (male or female) of the turtle. The eggs also produce heat which contribute to the incubation temperature of the eggs. Female turtles need higher temperature to develop.

The diagram below shows some turtle's eggs clustered close together in a nest by the beach.

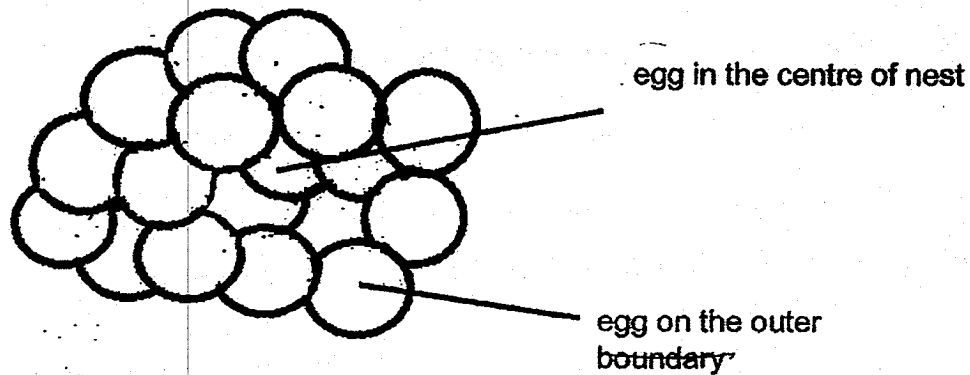

The eggs on the outer boundary and the eggs in the centre of the nest have different genders.

- (b) Write 'female' or 'male' to indicate the gender of the young. [1]

Young hatched from eggs in the centre of nest: _____

- (c) Explain your choice for (b). [1]

If the temperature of the surrounding becomes too high (above 28°C), only female turtles will be produced. This leads to a decrease in the number of sea turtles over time.

- (d) Explain why the number of sea turtles may decrease. [1]

34. The diagram below shows the food relationship between plants, aphids and insect X.

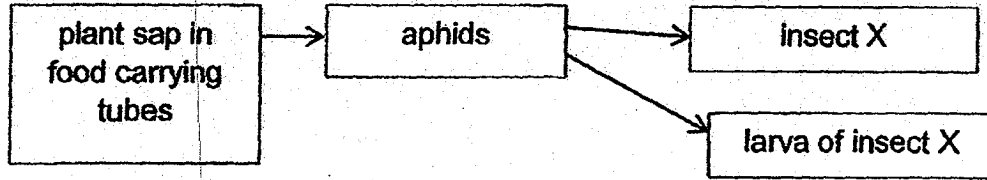

- (a) Explain why aphids are a pest to farmers. [1]

- (b) Explain how the introduction of insect X will help farmers. [1]

- (c) The adult insect X can lay 100 eggs at a time among the aphids on the leaves. How are the above two actions of the insect X useful for its survival? [2]

Lays 100 eggs:

Lays eggs among the aphids:

35 The picture below shows an electric iron.

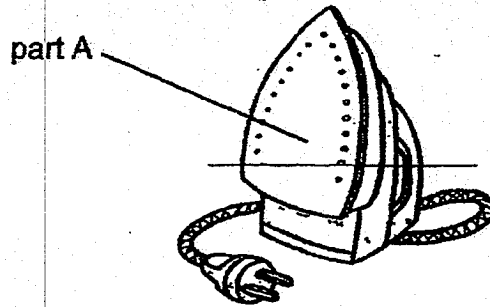

(a) State the material that is used to make part A of the electric iron and one property of the material used. [2]

Material: _____

Property: _____

When David poured water into an iron, he observed white clouds formed above the iron.

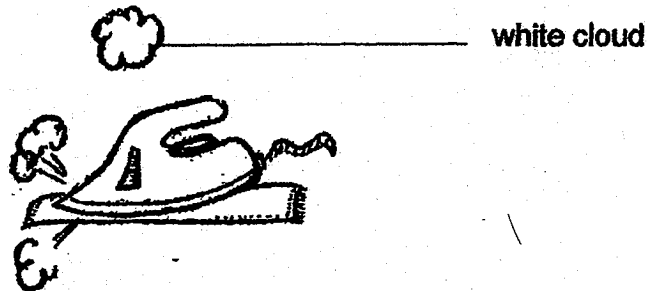

(b) Explain how the white clouds are formed. [2]

- 36 The diagram below shows a metal rim and wooden wheel. Both the metal rim and the wooden wheel are of similar size.

metal rim

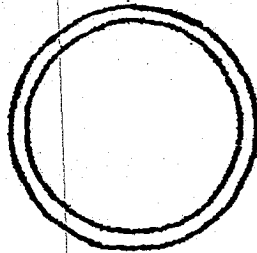

wooden wheel

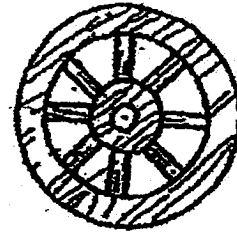

- (a) Identify the difference between metal and wood in terms of conductivity of heat. [2]

Wood: _____

Metal: _____

The following steps were carried out to make a cartwheel.

1	A large amount of heat is applied to the metal rim.
2	The hot metal rim is placed round the wooden wheel to form the cartwheel.
3	A large amount of cold water is poured over the cartwheel.

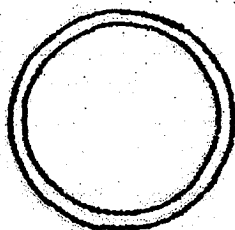

metal rim

+



wooden wheel

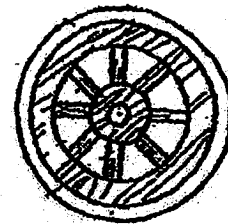

cartwheel

Question 36 is continued on page 11

- (b) Explain how step 1 and step 3 ensure the metal rim is fitted round a wooden wheel to form the cartwheel. [2]

(i) step 1:

(ii) step 3:

- 37 The diagram below shows two set-ups, A and B. In both set-ups the rubber stopper is fitted tightly into the flask. John poured an equal amount of water into each funnel.

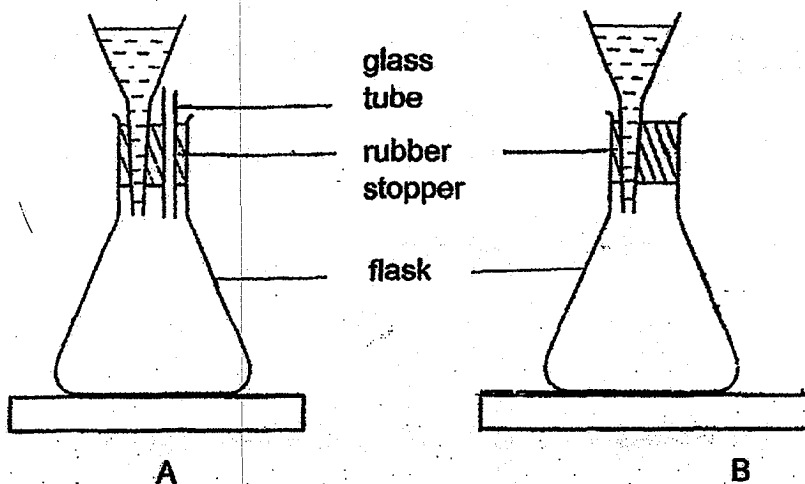

- (a) What would be his observations for the set-ups? [2]

(i) set-up A

(ii) set-up B

Question 37 is continued on page 12

In another experiment, John had 4 different types of balls. The four balls are made of different materials C, D, E and F.

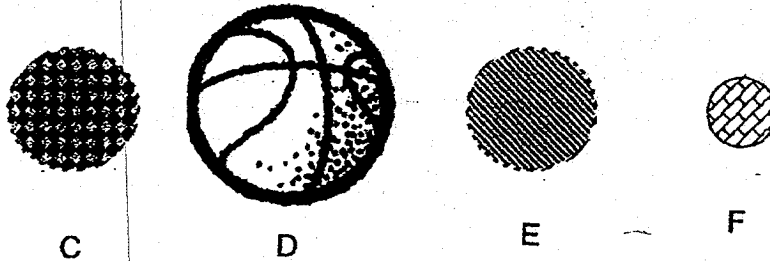

He wanted to find out if the material of the ball will affect the mass of the ball.

- (b) Which two balls should he choose? Give a reason for your choice. [1]

John concluded that material of a ball affects the mass of the ball.

- (c) Using a beam balance as shown below, describe the method and the result to confirm his conclusion. [2]

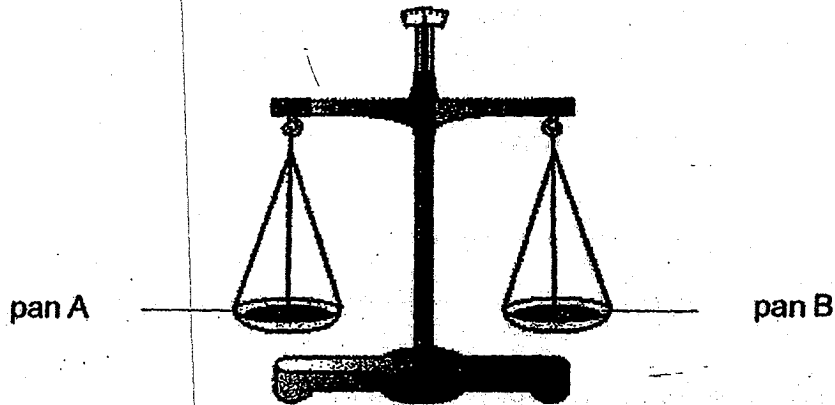

Method:

Result:

- 38 The diagram below shows three rods X, Y and Z placed at different positions of a circuit.

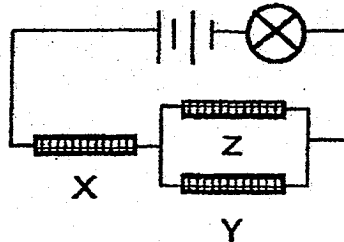

The bulb lights up in the circuit. Only two rods are conductors of electricity.

- (a) Which one of the rods, X, Y or Z is definitely a conductor of electricity?
Explain why.

[1]

In another experiment, the following circuit A has been set up. All the bulbs and batteries are working properly.

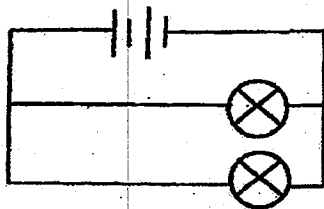

circuit A

- (b) What is the advantage of arranging the bulbs as shown in circuit A?

[1]

Question 38 is continued on page 14

- (c) The two bulbs in circuit A were re-arranged so that the bulbs in circuit A will remain lit for a longer time.

Draw a circuit diagram below to show the change.

[1]

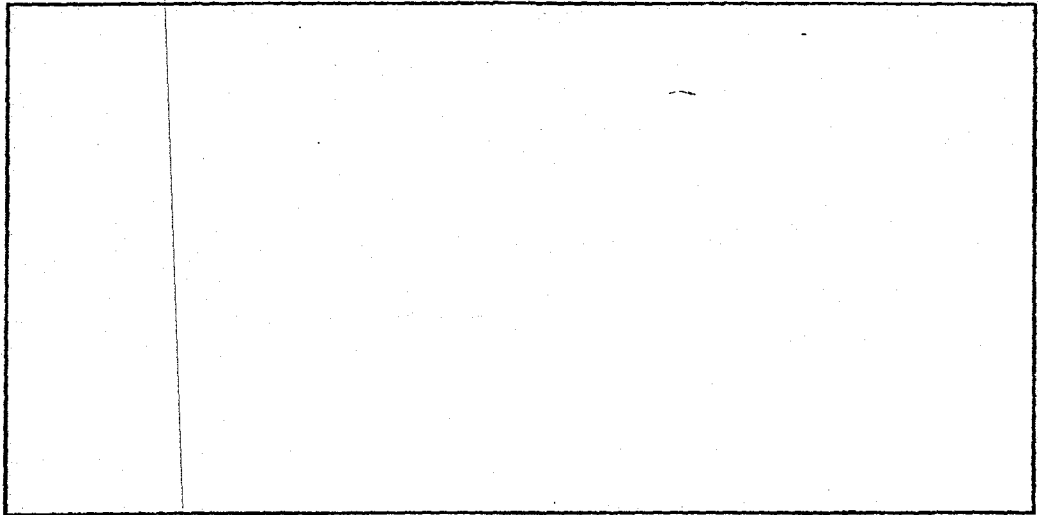

- 39 Andy released a yo-yo from one of his hands and a stone from the other hand above the floor as shown below. Both the yo-yo and the stone are of the same mass.

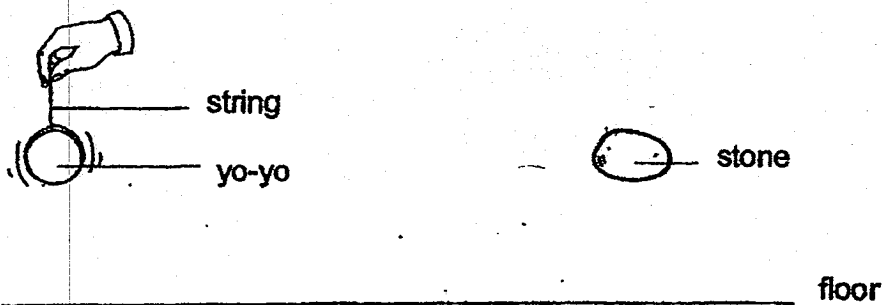

- (a) Fill in the boxes to show the main energy conversion as the yo-yo and stone were released from the hand to the floor. [1]

→

Andy observed the yo-yo spinning as it was falling but the stone did not spin.

- (b) Explain why the yo-yo fell slower than the stone in terms of energy changes. [1]

- (c) Andy also observed that yo-yo continued to move up and down for a few times before stopping completely. Explain why. [1]

- 40 A string is passed through a straw. A balloon is then taped firmly to the straw as shown below.

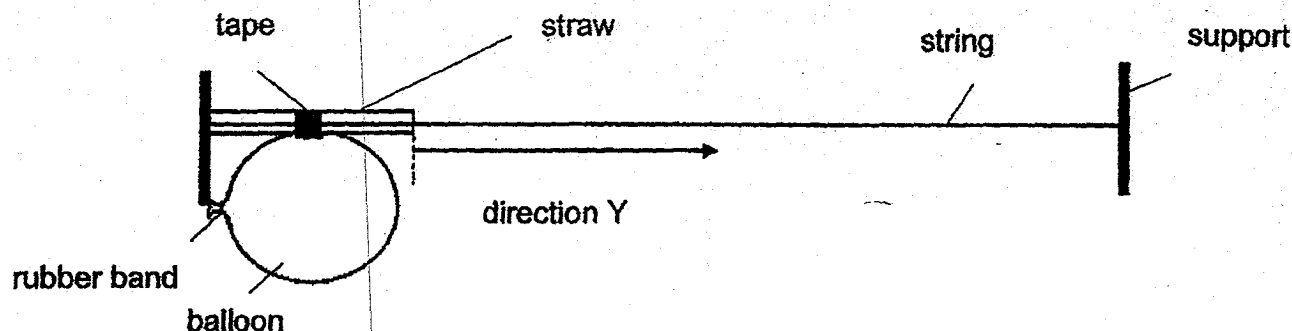

When the rubber band is removed, air rushed out of the balloon producing a force. This force caused the straw with the balloon to move in direction Y by 100cm.

Muthu prepared two similar set-ups. In the first set-up, he coated the string with substance T. He released the rubber band and measured the distance the straw moved for the two tries. He then repeated the experiment using substance V for the second set-up. The results are shown in the table below.

Substance coated on the string	Distance travelled by the straw (cm)	
	1 st try	2 nd try
T	154	140
V	160	161

- (a) Based on the results above, explain how substance V has affected the distance travelled by the straw compared to substance T. [2]

- (b) For substance T, the distance travelled by the straw was different for each try. What could he do to obtain a more reliable result? [1]

End of Paper

Answer Sheets

ROSYTH Pri 6 SA2/2019 SCIENCE

1.	4	6.	1	11.	2	16.	1	21.	4	26.	4
2.	2	7.	2	12.	4	17.	3	22.	4	27.	3
3.	1	8.	4	13.	3	18.	3	23.	3	28.	3
4.	4	9.	3	14.	4	19.	1	24.	2		
5.	3	10.	3	15.	1	20.	4	25.	2		

29a.Process-Photosynthesis

Gas-Oxygen

29b.There is not enough Animal X for Animal Y to feed on. So some animal Y died.

This led to a decrease in Animal Y.

29c.Birth rate of Animal X is higher that its death Rate.

30a.Livings Things respond to changes around them /Living Things can move by themselves. Living things need food to survive.

30b.Animal K can spread diseases. Animal K can compete for space/water.

Animal K can occupy habit of another animal.

31a.Part P receives Pollen Grains from another for pollination to take place.

31b.R Fruit protects the seeds/Helps to disperse the seeds.

31c.It attracts more bees to the flowers of plant X so this increases the chance of pollination to take place.

31d.Yes. It is to compare and confirm that the only variable affecting the amount of nectar produced is due to the expose to the sound of bees.

32a.Set Up A as the hydrilla plant take in carbon dioxide for photosynthesis and there is no snail to give out carbon dioxide.

32b.plants provide animals with shelter and hiding places from predators/ Plants can be a source of food for the animals./Plants provide places for animal to lay egg/Plants provide oxygen for animals to take in.

33a.As the amount of carbon dioxide increase, more heat is trapped so temperature of Earth increase. This causes the melting of the polar ice caps which cause the rising of sea levels.

33b.Female

33c.Eggs in the centre are surrounded by other eggs. It reduces the heat loss from the eggs in the centre to the surrounding air.

33d.There will not be enough male turtles to fertilize the eggs.

34a. Aphids feed on plant sap so the plant will have less food to grow. This will reduce plant growth.

34b. Insect X feeds on aphids so there will be fewer aphids to feed on the plant sap. Plants can grow more healthy.

34c. Lay 100 eggs - Increase the chance of the eggs developing/ hatching into young and growing into adults.

Lay eggs among aphids - When the eggs hatch the young will have a ready source of food to feed on. They can feed on aphids.

35a. Material : Iron Property: - Good conductor of heat

35b. This is because the water gained heat from the hot iron and evaporated to form water vapor. The water vapor then rose and came into contact with the surrounding air. The water vapors would then lose heat to the surrounding air and condensed to form tiny water droplets, which collect and appear as the white cloud.

36a. Wood :- Poor conductor of heat Metal :- Good conductor of heat

36b. Step 1 : Metal rim will gain heat and expand so it will be bigger than the wooden wheel.

Step 3: Metal rim will lose heat and contract so it will hold the wooden wheel tightly.

37ai. Water flowed into flask quickly

37aii. Water flowed into flask slowly

37b. C and E. Both balls are of similar size / Volume.

37c. Method: Place ball C on pan A and ball E on pan B.

Results: The beam balance will tilt downwards to one side.

38a. X is a conductor of electricity so the circuit is closed and electricity flows through for bulb to light up.

38b. The bulbs can be independently controlled. When one bulb fuses, the other bulb can still be lit. Bulbs will shine more brightly than when they are arranged in series.

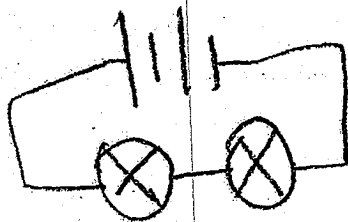

38c.

39a. Gravitational Potential Energy \rightarrow Kinetic Energy

39b. some of the Kinetic energy of the falling yo-yo is converted to the kinetic energy and heat energy of the spinning yoyo.

39c. Not all of the kinetic energy is converted to heat energy of the spinning yoyo. The yo-yo still had some kinetic energy.

40a. With substance V, the distance travelled by the straw is greater. Substance V reduced more friction between the straw and the string.

40b. Repeat the experiment a few more time, and obtain the average result from the experiment.

