

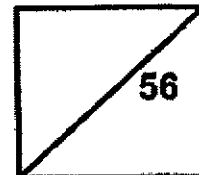

Rosyth School
Preliminary Examination 2022
SCIENCE
Primary 6

Total

Marks:



Name: _____

Class: Pr 6- _____ Register No. _____

Date: 25 August 2022

Parent's Signature: _____

Duration: Total time for Booklets A and B: 1 h 45 min

Booklet A

Instructions to Pupils:

1. Please do not turn this page until you are told to do so.
2. Follow all instructions carefully.
3. Answer all questions.
4. This paper consists of 2 booklets, Booklet A and Booklet B.
5. For questions 1 to 28 in Booklet A, shade the correct ovals on the Optical Answer Sheet (OAS) provided using a 2B pencil.

This booklet consists of 22 printed pages (including cover page).

This paper is not to be reproduced in part or whole without the permission of the Principal.

For each question from 1 to 28, four options are given. One of them is the correct answer. Make your choice (1,2,3 or 4). Shade the correct oval (1,2,3 or 4) on the Optical Answer Sheet. (56 marks)

1. Which one of the following characteristics can be used to differentiate between birds and mammals?
- (1) number of legs
 - (2) presence of wings
 - (3) types of body coverings
 - (4) methods of reproduction

2. The diagram below shows a unicellular organism found in ponds.

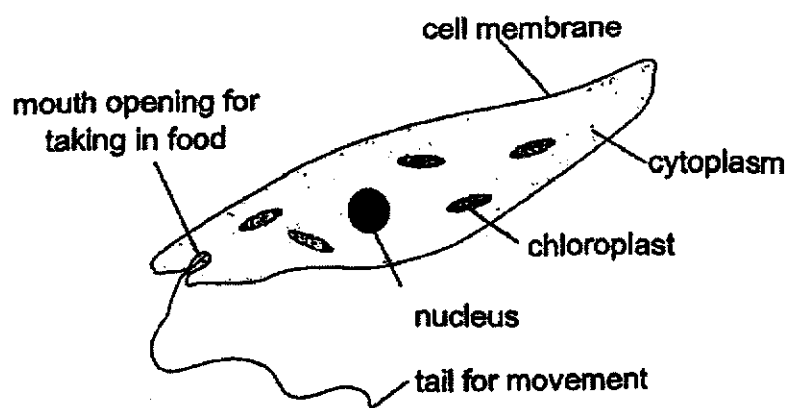

Which of the following statement(s) correctly describe(s) the above unicellular organism as more animal-like?

- A It makes its own food.
 - B It is a food consumer.
 - C It can move from place to place.
- (1) B only
 - (2) C only
 - (3) A and B
 - (4) B and C

3. A clear layer of oil is applied to the upper side and underside of all the leaves of a potted plant as shown in the diagram below.

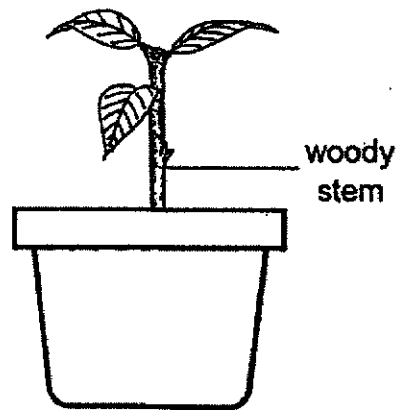

The potted plant was watered daily and placed in the garden for a week. The plant wilted because the leaves _____.

- (1) cannot trap sunlight
- (2) cannot take in water
- (3) reflected light at a faster rate
- (4) carried out photosynthesis at a slower rate

4. The diagram below shows a fish with parts labelled 1, 2, 3 and 4.

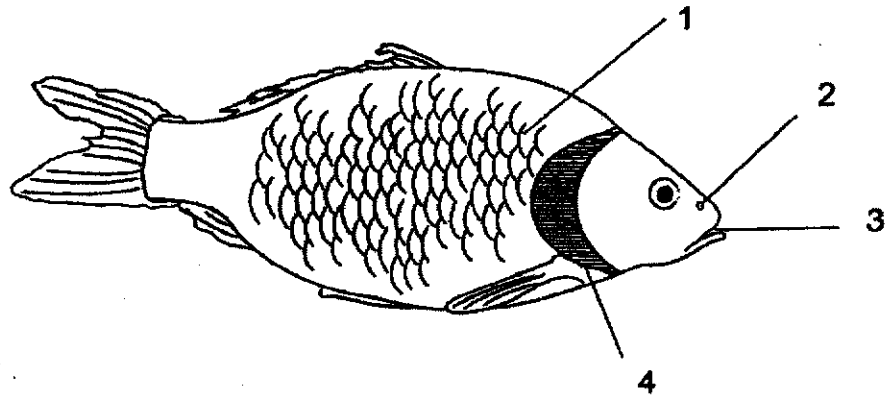

Which part of the fish allows exchange of gases?

- (1) 1
- (2) 2
- (3) 3
- (4) 4

5. Evan carried out an experiment with two test tubes, X and Y, as shown below.

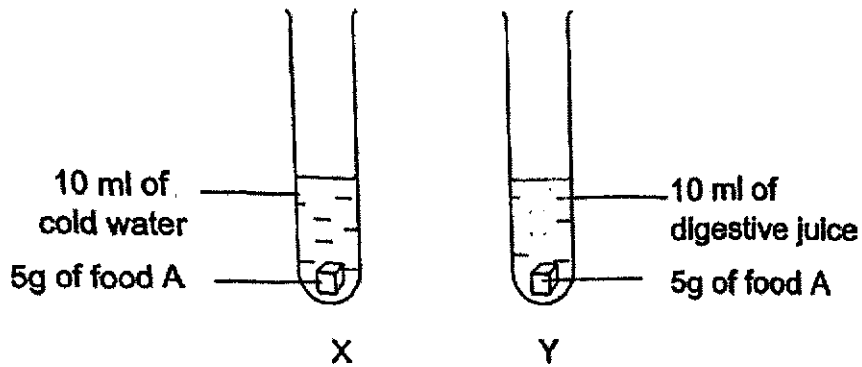

After 30 minutes, he observed the changes as shown below.

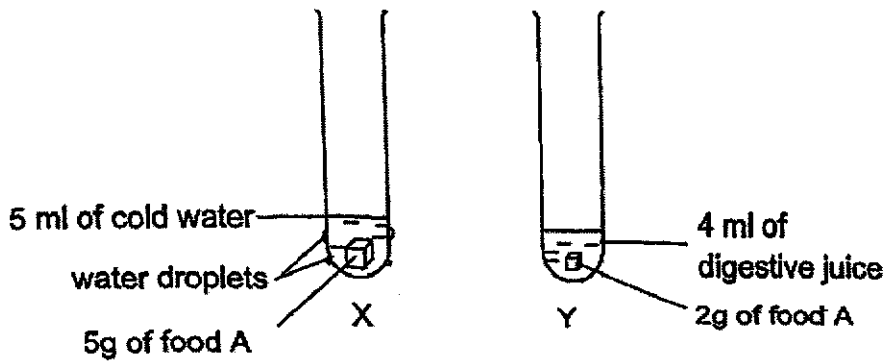

Identify the processes involved in each test tube.

	Test tube X	Test tube Y
(1)	Evaporation and condensation	Evaporation only
(2)	Evaporation and digestion	Digestion only
(3)	Evaporation and condensation	Evaporation and digestion
(4)	Evaporation only	Evaporation and digestion

6. The diagram below shows the female human reproductive system. Both sides of the fallopian tubes are blocked.

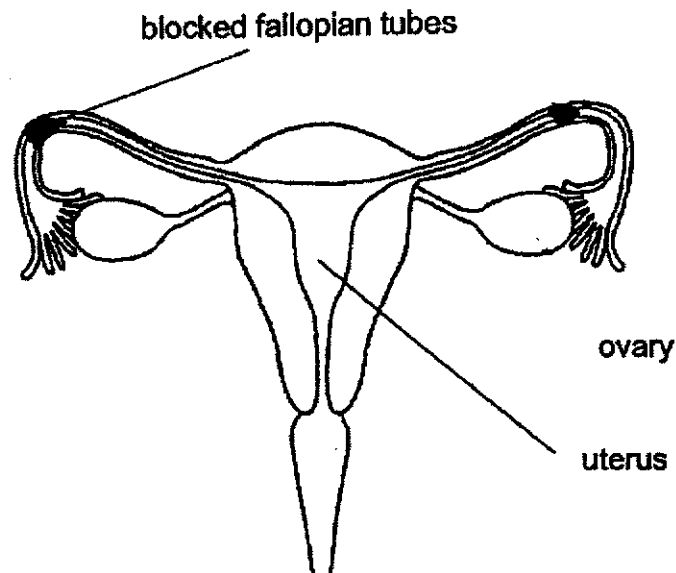

How does the blocked fallopian tubes prevent fertilisation from taking place?

- (1) The ovary cannot produce and release an egg.
- (2) The sperm cannot fuse with the egg in the fallopian tubes.
- (3) The egg cannot move to the uterus to fuse with the sperm.
- (4) The sperm cannot swim to the fallopian tubes to fuse with the egg.

7. The set-up below is used to study the rate of photosynthesis.

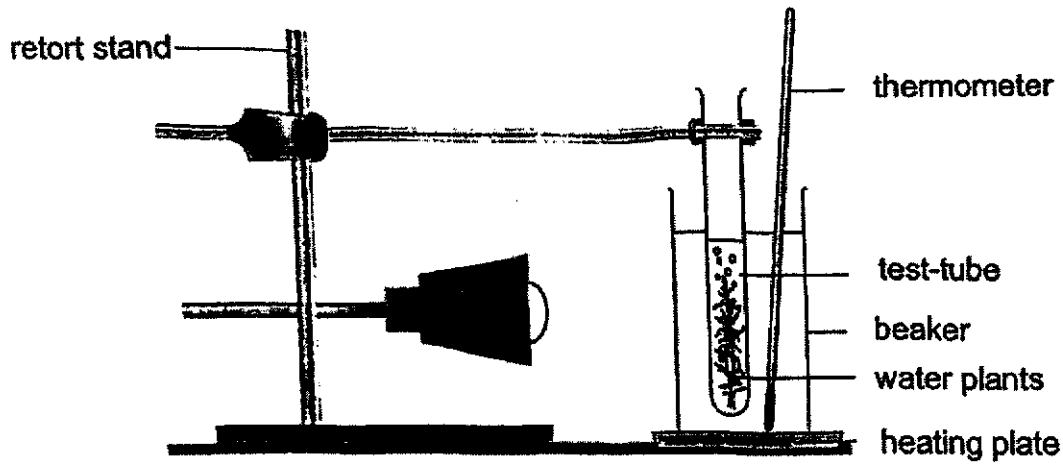

Ravi wants to find out how the temperature of the water affects the rate of photosynthesis. Which of the following should he do to improve the accuracy of his results?

- (1) Repeat the experiment a few more times.
- (2) Use a light sensor to measure the intensity of the light.
- (3) Set up another experiment with no plants in the test tube.
- (4) Use an oxygen sensor to measure rate of photosynthesis.

8. The diagram below shows the life cycle of plant X.

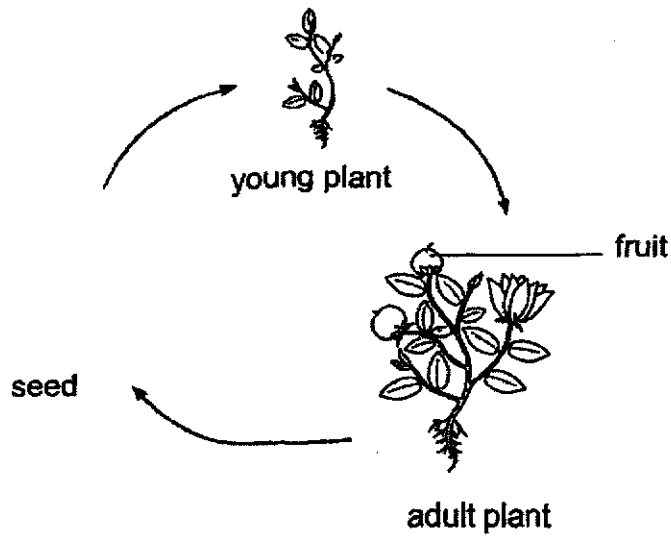

Which of the following is **not true** about the life cycle of plant X?

- (1) Plant X is a flowering plant.
- (2) Oxygen is required throughout the life cycle of plant X.
- (3) The fruit has seeds to ensure continuity of its life cycle.
- (4) Carbon dioxide is required for every stage of the life cycle.

9. Study the classification chart below.

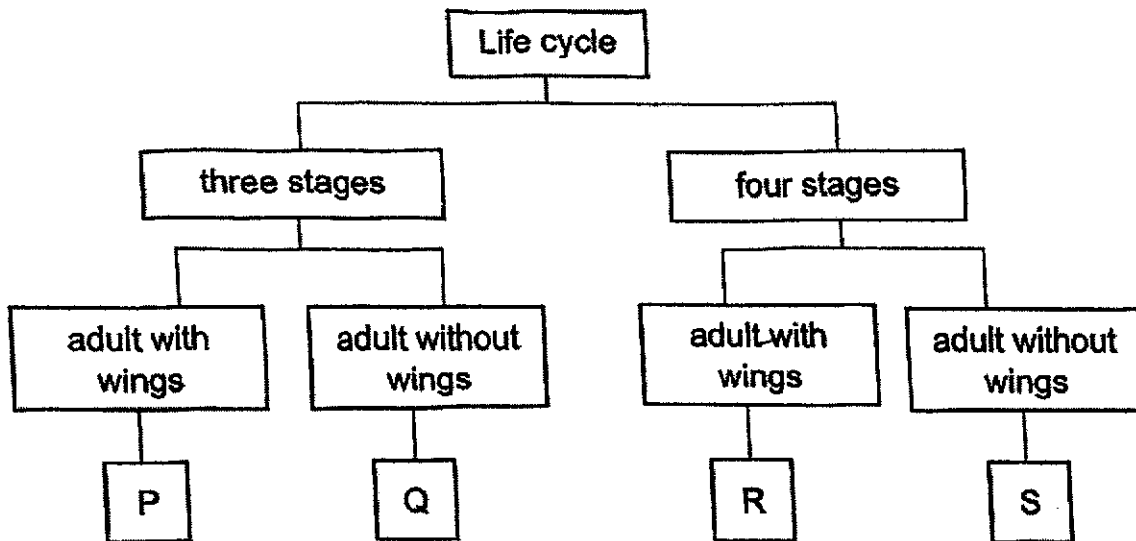

The diagram below shows the young and adult of insect A.



young

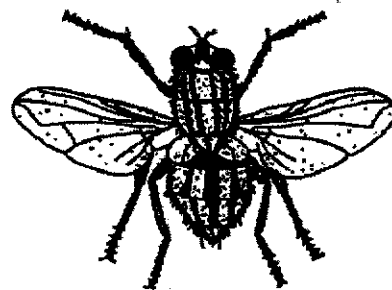

adult

Which group, P, Q, R or S, does insect A belong to?

- (1) P
- (2) Q
- (3) R
- (4) S

10. Global warming is harmful to our environment. Which of the following is the cause of global warming?
- (1) flooding
 - (2) soil erosion
 - (3) deforestation
 - (4) melting of icebergs
11. Study the food web below.

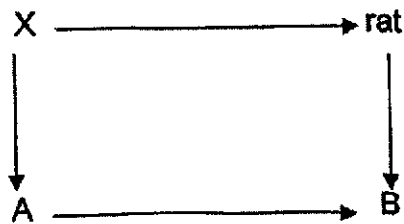

Which one of the following groups would complete the food web?

	A	B
(1)	Prey only	Predator only
(2)	Both a prey and predator	Both a prey and predator
(3)	Both a prey and predator	Predator only
(4)	Prey only	Both a prey and predator

12. Joseph wanted to find out how oil spill affects pond habitat. He wanted to prepare two set-ups, X and Y. Which of the following shows a fair experiment?

	Set-up X	Set-up Y
(1)	3100ml of pond water 10 tadpoles 0 ml of oil	3000ml of pond water 10 tadpoles 100 ml of oil
(2)	3000ml of pond water 10 tadpoles 0 ml of oil	3000ml of pond water 10 tadpoles 100 ml of oil
(3)	3000ml of pond water 10 tadpoles 0 ml of oil	3000ml of tap water 10 tadpoles 100 ml of oil
(4)	3000ml of pond water 0 tadpoles 0 ml of oil	3000ml of pond water 10 tadpoles 100 ml of oil

13. Turtles live in the sea. They lay their eggs on sandy beaches.

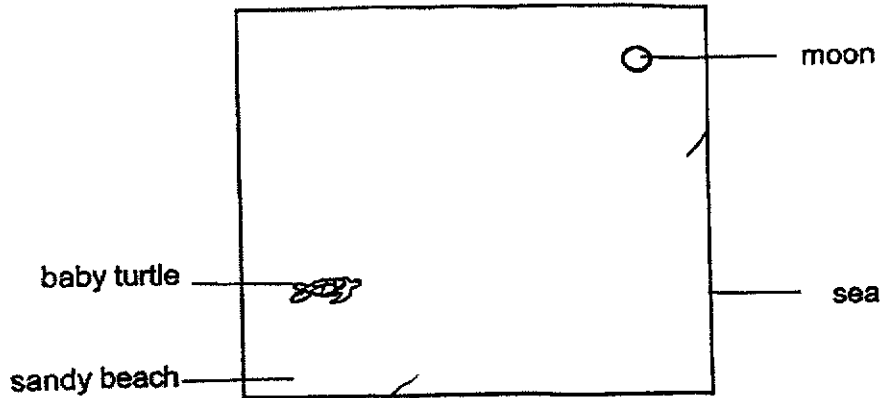

An investigation was carried out to study the effect of beach litter on the crawl time required for baby turtles to reach the sea. The time that baby turtles required to crawl in different amount of litter (low, medium, high, and a control situation) was recorded.

The results showed that amount of litter increased the crawl time of the baby turtles compared to the control situation. It was also observed that as the amount of litter increased, the amount of crawl time increased.

Which one shows the most possible results for the above conclusion?

(1)

Amount of litter	Crawl time (min)
Low	11.8
Medium	11.8
High	14.1
Zero	10.6

(2)

Amount of litter	Crawl time (min)
Low	11.4
Medium	12.0
High	15.8
Zero	10.6

(3)

Amount of litter	Crawl time (min)
Low	14.0
Medium	12.0
High	15.8
Zero	10.6

(4)

Amount of litter	Crawl time (min)
Low	10.5
Medium	13.0
High	17.1
Zero	20.8

14. The picture below shows a water lily in a lake.

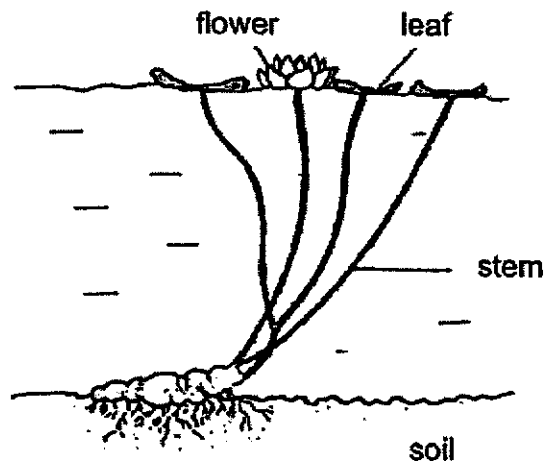

Water lily has adaptations to survive in its habitat. Which of the following is not an adaptation needed for its survival in a lake?

- (1) Deep roots to absorb more water from the soil.
- (2) Flexible stems to withstand the movements of water.
- (3) Dark green leaves on the upper side to trap maximum sunlight.
- (4) More stomata on the upper side of the leaves for gaseous exchange.

15. The diagram below shows four identical bulbs in working condition connected in a circuit. How many bulb(s) will light up?

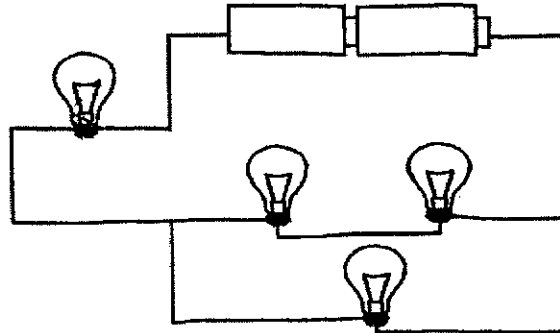

- (1) 0
- (2) 2
- (3) 3
- (4) 4

16. Jerry set up four different circuits using identical bulbs and batteries as shown. In which circuit would bulb T be the brightest?

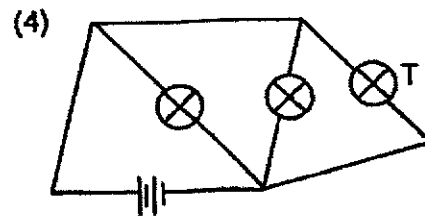
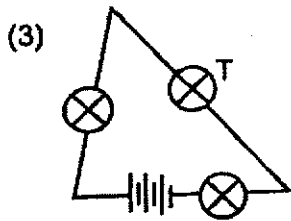
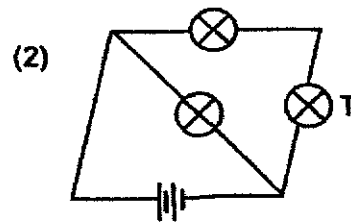
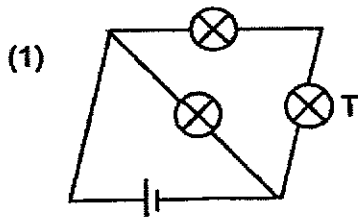

17. Which of the following statements about evaporation is correct?

- (1) It occurs at fixed temperature.
- (2) It involves heat gain to the surroundings.
- (3) It is affected by the surrounding temperature.
- (4) It involves a change from gaseous to liquid state.

18. Four different containers, A, B, C and D, were left at the same place. Each container contained 500 cm^3 of water at the same temperature. At every hour the volume of the water in each container was measured and recorded. The graph below shows how the volume of water in the container changed over six hours.

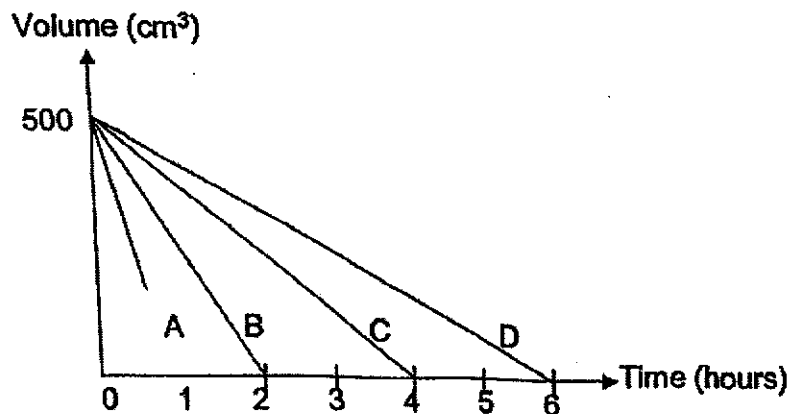

Based on the graph, what can you deduce?

- (1) Water in D has a larger exposed surface area than water in A.
- (2) Water in C has a larger exposed surface area than water in B.
- (3) Water in B has a smaller exposed surface area than water in D.
- (4) Water in C has a smaller exposed surface area than water in A.

19. Clara carried out an experiment at a room temperature of 28°C . She placed a beaker of water at 10°C on a weighing scale and covered the beaker with a lid as shown below.

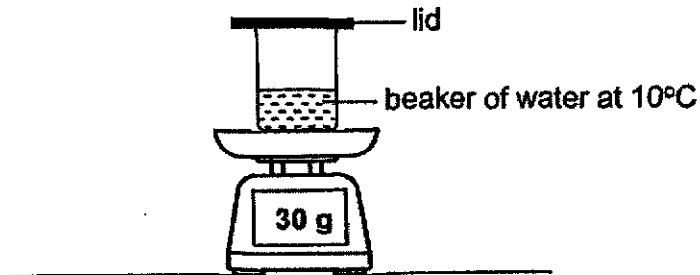

After 30 minutes, Clara recorded the temperature of water and mass of the set-up. Which of the following could most likely be the readings?

	Temperature of water ($^{\circ}\text{C}$)	Mass of set-up (g)
(1)	10	28
(2)	10	32
(3)	28	28
(4)	28	32

20. The diagram below shows a bottle containing honey. Peter poured all the honey from the bottle to the beaker.

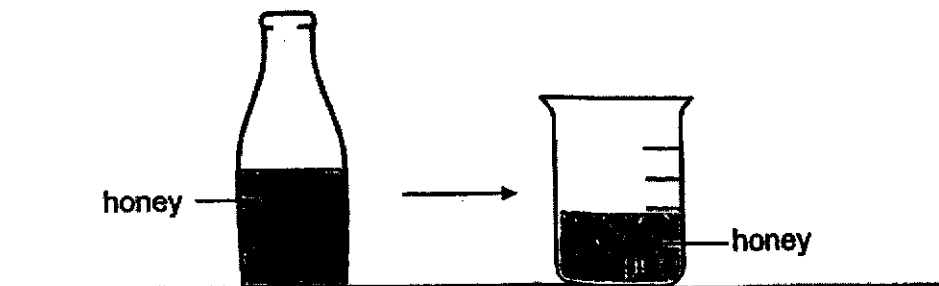

Based on the observation, what property can you conclude about honey?

- (1) Honey has mass.
- (2) Honey has a definite volume.
- (3) Honey has an indefinite shape.
- (4) Honey cannot be compressed.

21. The diagram below shows a new sock.



Jane uses a pair of scissors to cut the new sock and made it into a face mask.

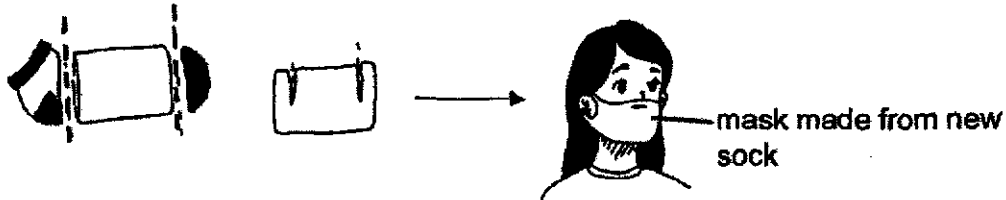

Which property makes the sock a possible material to be used as a face mask?

- (1) It is strong.
- (2) It is flexible.
- (3) It is waterproof.
- (4) It is transparent.

22. Four identical pastas, A, B, C and D, were placed into four identical beakers. The beakers contained different volume and temperature of water. The pasta was taken out when it started to float on the surface of the water which indicates that it is cooked. The time taken for the pasta to cook was measured.

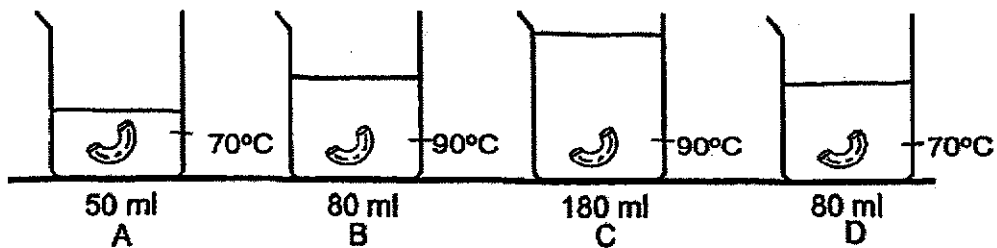

Using the results, the pastas were ranked according to the time taken to cook. Shortest time to cook was ranked first. Which one of the pastas will be second and third in rank respectively?

	Second in rank to be cooked	Third in rank to be cooked
(1)	B	D
(2)	B	A
(3)	C	D
(4)	C	B

23. Siti placed a box under a light bulb as shown below. The box was moved randomly to three different positions, W, X and Y, and the size of the shadow formed on the ground was measured.

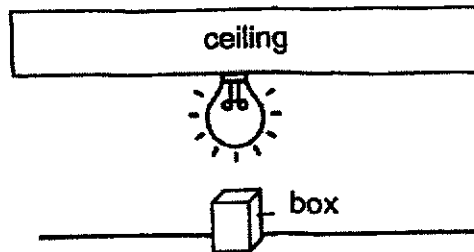

She recorded the results in the graph shown below.

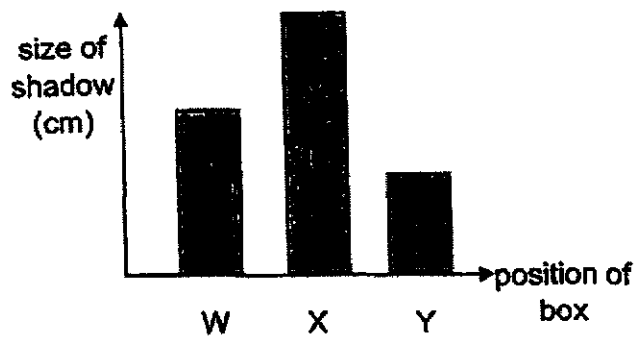

Which of the following shows the correct position of the box?

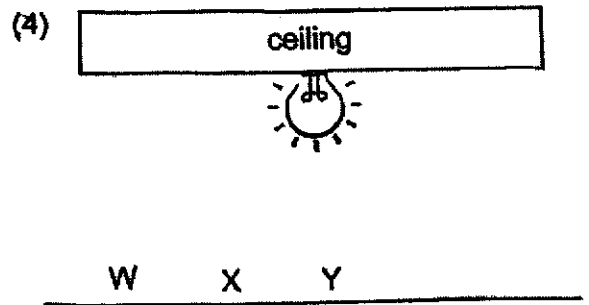
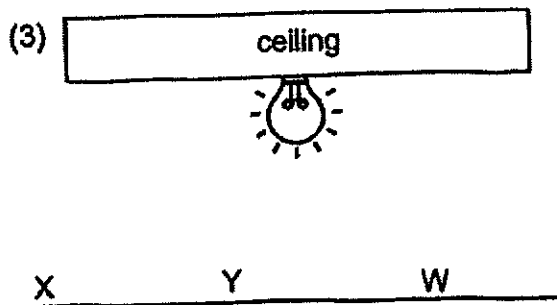
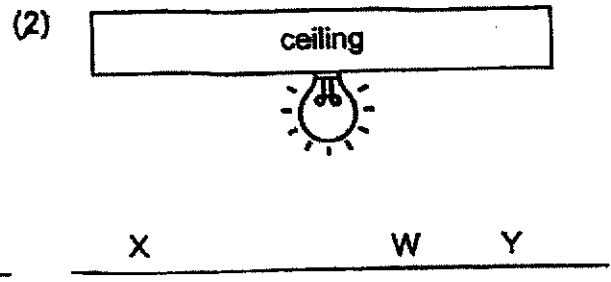
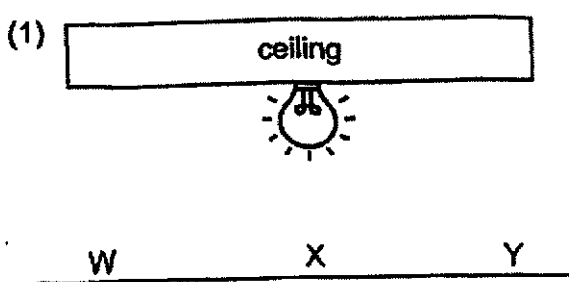

24. Dan likes to use his periscope to see a bird.

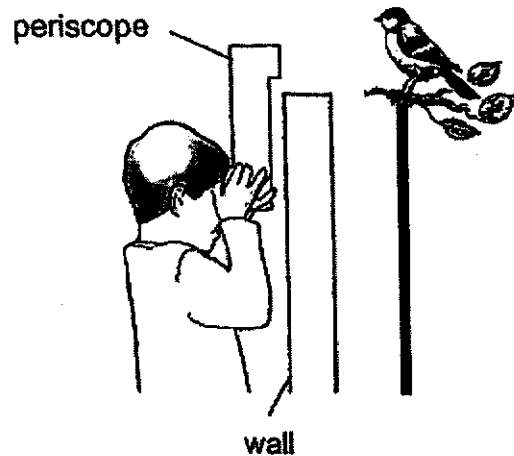

For Dan to see the bird, what is the least number of mirror(s) needed to be placed inside the periscope?

- (1) 1
 - (2) 2
 - (3) 3
 - (4) 4
25. Keri was carrying a stack of books and a bouncy ball. As she was walking, the bouncy ball fell to the ground. When it hits the ground at B, the ball changes its shape and then it bounces to C.

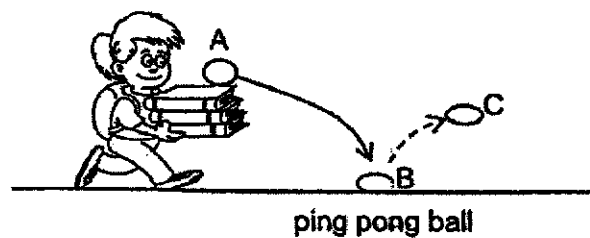

What is the energy conversion when the ball hits the ground at B?

- (1) kinetic \rightarrow sound + heat
- (2) gravitational potential \rightarrow kinetic
- (3) kinetic \rightarrow sound + heat + elastic potential
- (4) gravitational potential \rightarrow kinetic + sound + elastic potential

26. The diagram below shows a phone holder for a car. Material X is pasted on the phone cover. The phone with the cover is then safely secured on the phone holder in the car.

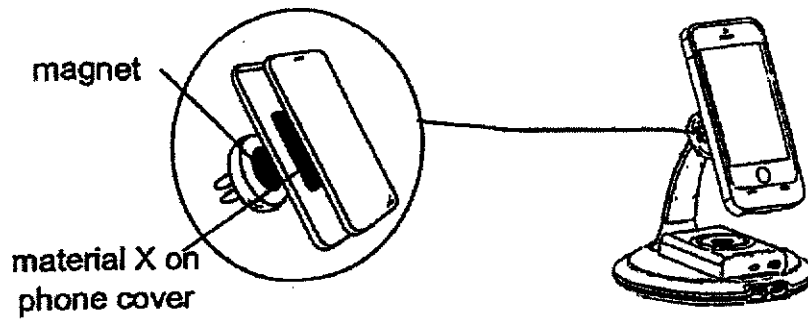

Which of the following statement is definitely correct?

- (1) Material X must be a magnet.
- (2) Material X cannot be a magnet.
- (3) Material X is made of a magnetic material.
- (4) Material X is made of non-magnetic material.

27. A mass of load was hung on a spring and its extension was recorded as shown below.

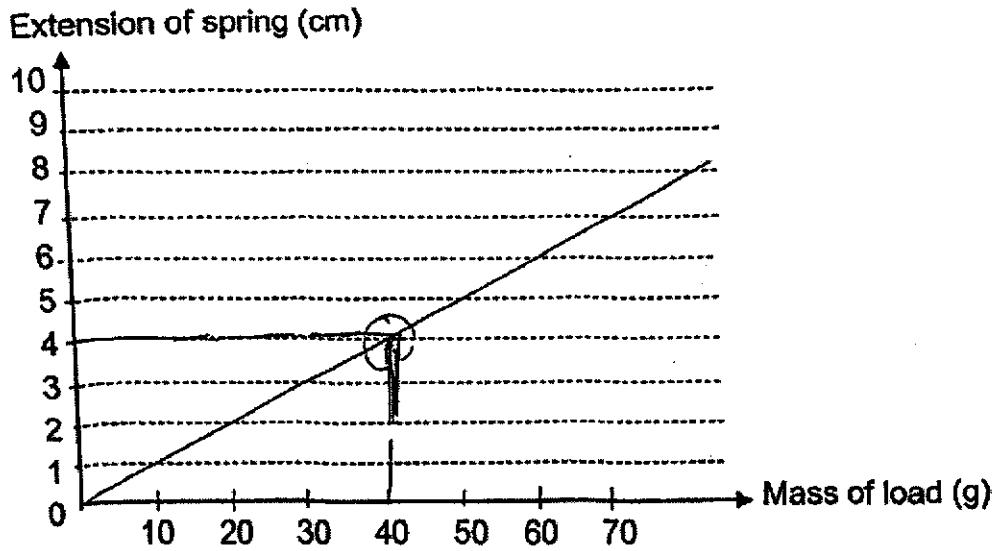

The original length of the spring was 5 cm. What was the length of the spring when a load of 40 g was hung on it?

- (1) 4 cm
- (2) 5 cm
- (3) 9 cm
- (4) 10 cm

28. A group of students made a structure as shown below to drop an egg from a height without breaking the egg.

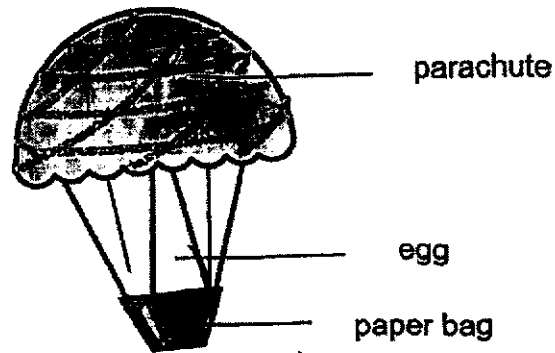

The structure helps to _____.

- (1) increase air resistance
- (2) decrease gravitational force
- (3) increase the speed at which it hits the ground
- (4) decrease the friction between the egg and the ground

Go on to Booklet B



Rosyth School
Preliminary Examination 2022
SCIENCE
Primary 6

Name: _____

Total
Marks:

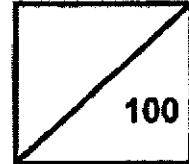

Class: Pr 6- _____ Register No. _____

Date: 25 August 2022 Parent's Signature: _____

Duration: Total time for Booklets A and B: 1 h 45 min

Booklet B

Instructions to Pupils:

1. Please do not turn this page until you are told to do so.
2. Follow all instructions carefully.
3. Answer all questions.
4. Use a dark blue or black ballpoint pen to write your answers in the space provided for each question.
5. Do not use correction fluid/tape or highlighters.

	Maximum	Marks Obtained
Booklet A	56 marks	
Booklet B	44 marks	
Total	100 marks	

* This booklet consists of 16 printed pages (including cover page).

This paper is not to be reproduced in part or whole without the permission of the Principal.

For questions 29 to 41, write your answers in the space provided. **(44 Marks)**

- 29 Neesha and Dave recorded their observations of some animals that they had found in a garden in the table below.

Animal	Number of legs	Number of wings
P	6	4
Q	8	0
R	2	2
S	6	0

- (a) Based on the information given, Neesha is very certain that P and S are insects. Do you agree? Explain why. [1]

- (b) Neesha wanted to draw a checklist to differentiate living things from non-living things. She has done one characteristic as shown in the table below. Complete the table below for (ii) and (iii) with two more characteristics. [2]

	Characteristics of living things
i	It responds to changes.
ii.	
iii.	

Do not write in the margin.

Do not write in the margin.

Do not write in the margin.

30 The instrument shown below is used to measure water uptake by a plant. As water is taken up, the bubble will move along the glass tube.

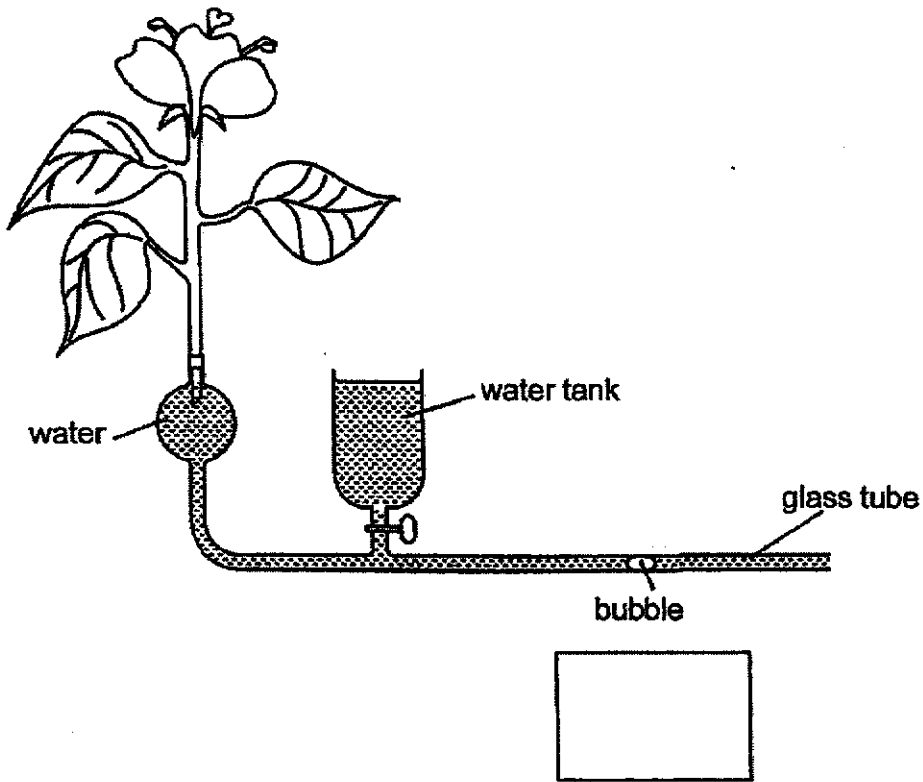

Do not write in the margin.

Do not write in the margin.

(a) In the box above, draw an arrow to show the direction that the bubble will move when water is taken up by the plant. [1]

(b) Describe the pathway taken by the water as it moves from the glass tube into the surrounding air. [2]

Do not write in the margin.

- 31 When people exercise, the volume of blood flow per minute to different parts of the body changes.
This is shown in the bar chart below.

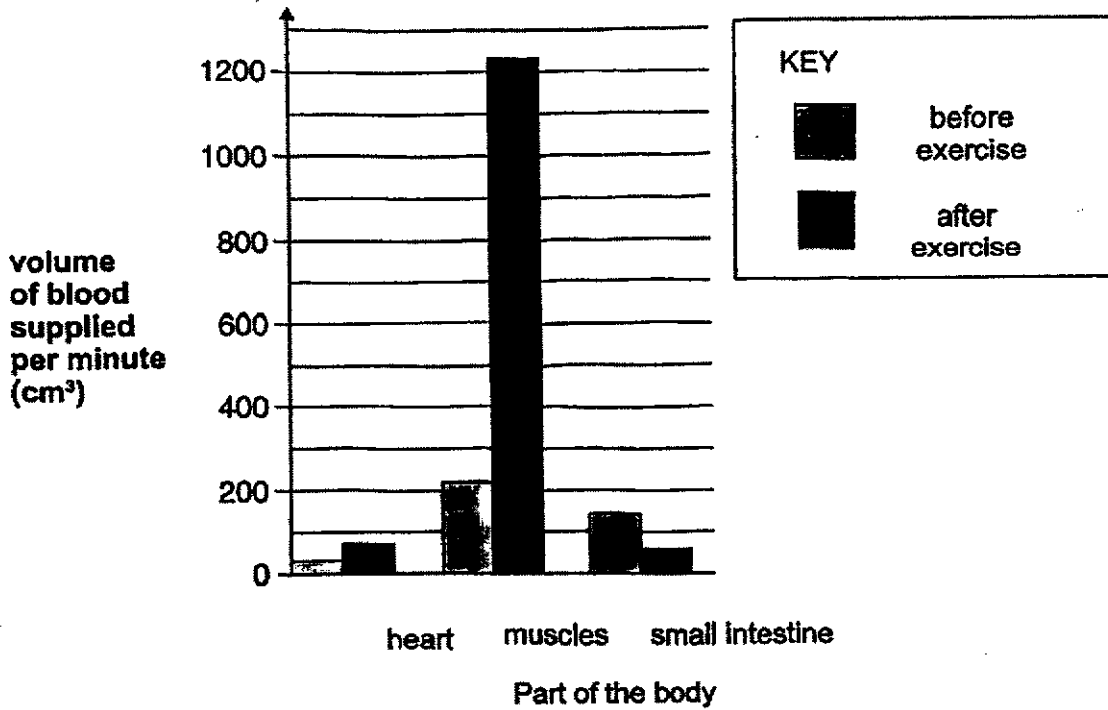

Do not write in the margin.

Do not write in the margin.

- (a) State the main organ system responsible for the changes in the volume of blood supplied per minute during an exercise. [1]

- (b) Describe how oxygen in the environment reaches the muscles. [2]

- (c) Based on the results in the bar chart, explain why we should not exercise just after eating a meal. [1]

Do not write in the margin.

32 Study the two types of fruits, A and B, shown below.

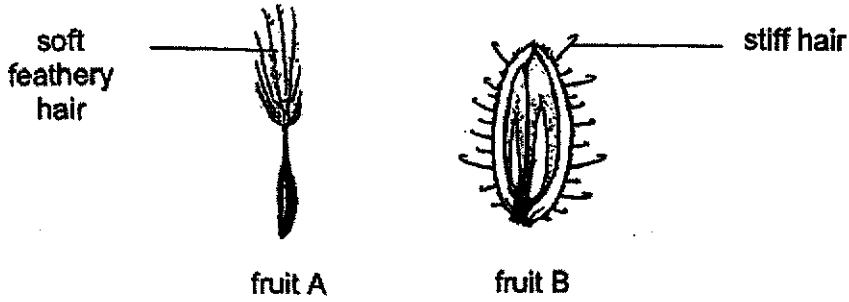

(a) How do the hairs on the fruits help in the growth of young plants? [1]

(b) The diagrams below show the seed dispersal of a plant.

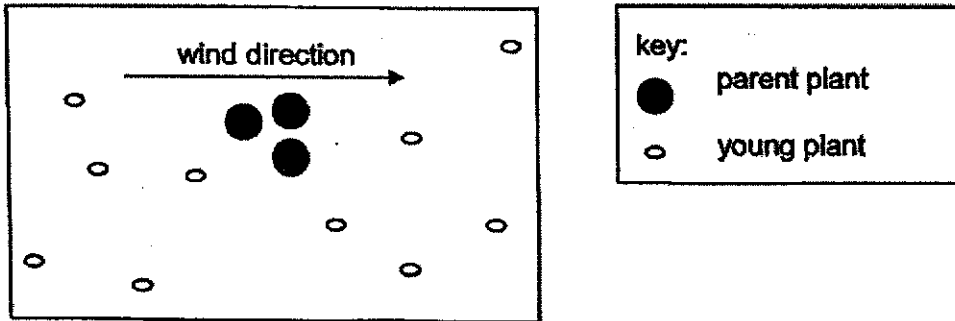

Which fruit, A or B, is more likely to belong to the plant above? Explain your answer. [1]

Do not write in the margin.

Do not write in the margin.

Do not write in the margin.

33 The graph below shows the change in the global average temperature over a period of 50 years as the amount of carbon dioxide increased in the air.

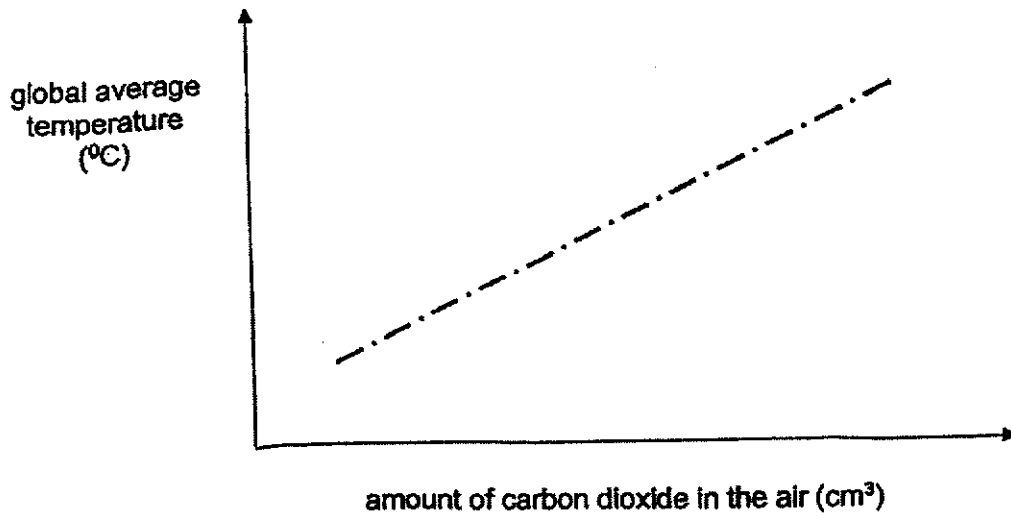

Do not write in the margin.

(a) Explain why the global average temperature increased as the amount of carbon dioxide in the air increased. [1]

(b) Over the 50 years, scientists observed that plants grew bigger. Explain the cause of their observation. [1]

(c) In addition, scientists observed that plants have more leaves over the 50 years. This caused the soil to be drier as less raindrops fell from the leaves onto the soil. Explain why. [1]

Do not write in the margin.

Do not write in the margin.

- 34 The diagram below shows part of a food web in a field.

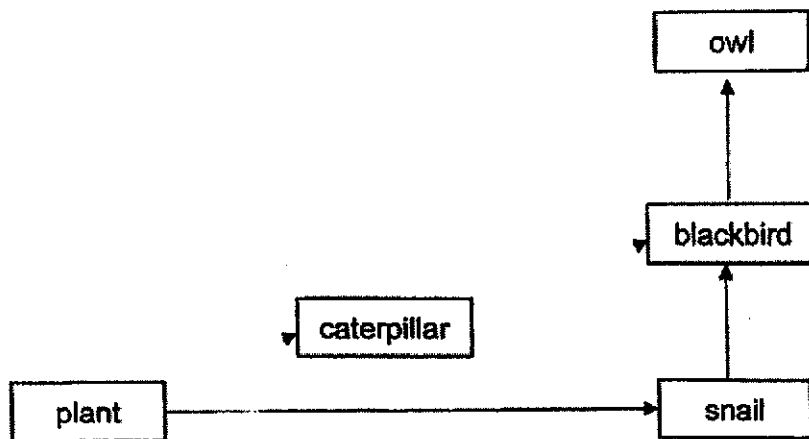

- (a) Based on the food web shown above, identify a food chain. [1]

- (b) Explain one way how an increase in the number of snails may result in the decrease in the number of caterpillars. [1]

- (c) Other than carbon dioxide, how do plants benefit from snails? [1]

Do not write in the margin.

Do not write in the margin.

Do not write in the margin.

35 Tristan created an apparatus to keep his water warm for a longer period of time. He wanted to find out how the number of stands affect the temperature of water in his apparatus. Tristan poured 100 ml of water (55°C) into each of the apparatus and placed each apparatus into a water bath as shown below.

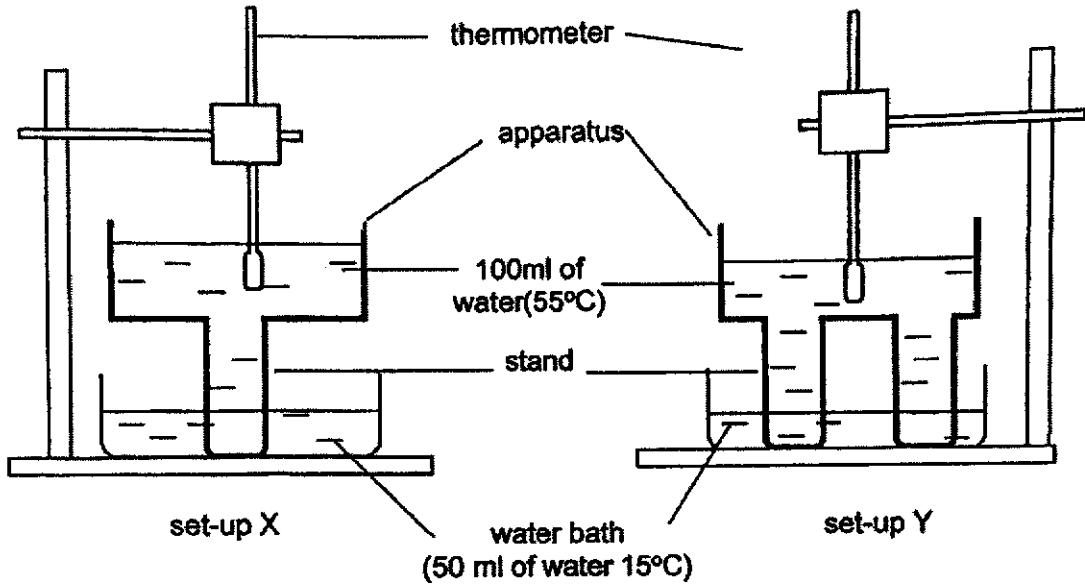

Do not write in the margin.

Do not write in the margin.

Tristan recorded the temperature of water in the apparatus every five minutes and drew a graph to show his results.

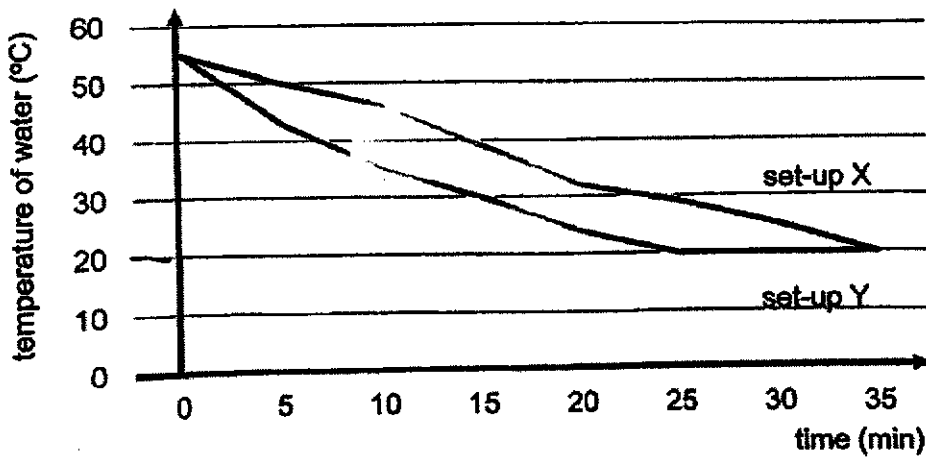

Question 35 continues on page 9

Do not write in the margin.

- (a) State the room temperature in the experiment. [1]

- (b) What is the relationship between the number of stands and the temperature of the water in the apparatus? [1]

The diagram below shows a picture of bird F. It spends a lot of time wading in the water to look for food.

legs

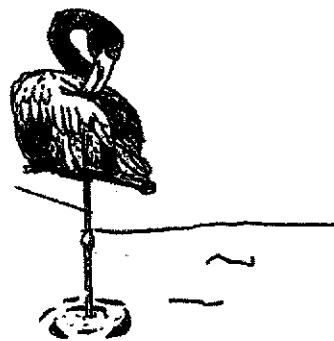

- (c) When the water in the lake is cold, it often stands on one leg. Identify the type of adaptation displayed by bird F. [1]

- (d) Based on Tristan's experiment, explain why the bird stands on one leg. [1]

Do not write in the margin.

- 36 Betty set up a circuit tester as shown below to test the electrical conductivity of four materials W, X, Y and Z.

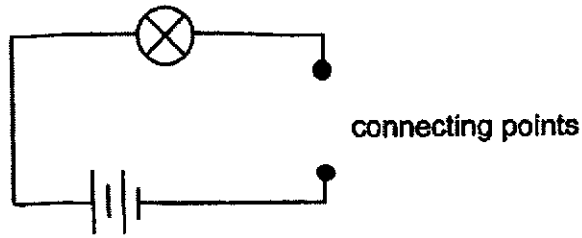

She joined material W at the connecting points and record her observations in a table as shown below. She repeated the experiment with materials X, Y and Z.

Material	W	X	Y	Z
Did bulb light up?	Yes	No	Yes	Yes

- (a) Complete the classification chart below using the information from the table above. Write down suitable sub-headings and the classify W, X, Y and Z in the boxes provided. [1]

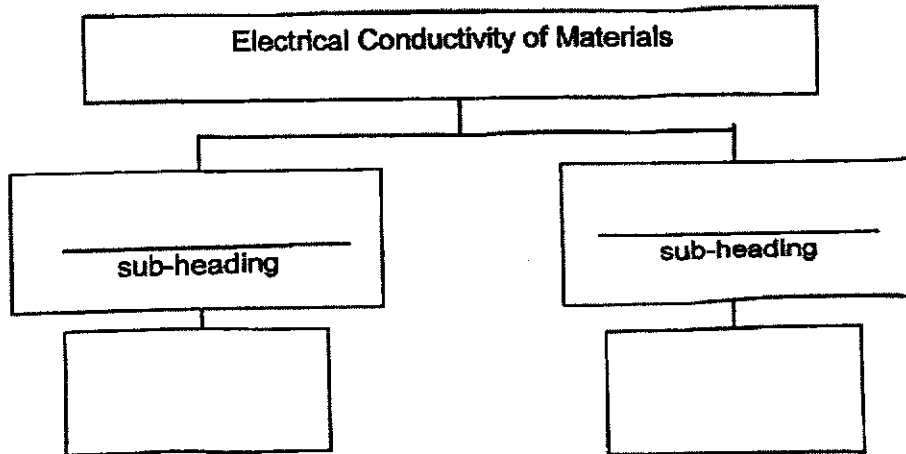

Do not write in the margin.

Do not write in the margin.

Question 36 continues on page 11

Do not write in the margin.

Betty then set up two similar electric circuits as shown below. All batteries, bulbs and wires are in working condition.

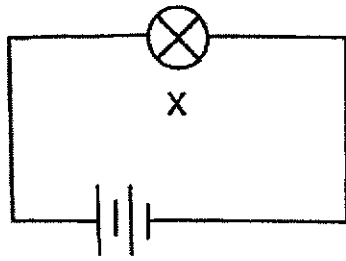

circuit P

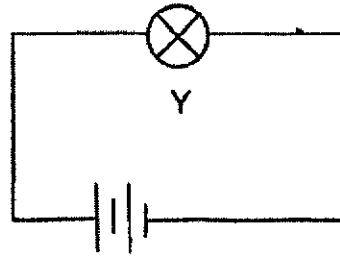

circuit Q

(b) The brightness of the bulbs, X and Y, were the same. Betty added another bulb in a different arrangement in circuits, P and Q. She observed the brightness of the bulb X remained the same while that of bulb Y was dimmer.

- (i) Based on the observation, state the arrangement of the two bulbs in circuits, P and Q respectively. [2]

Circuit P: _____

Circuit Q: _____

- (ii) Explain her observation. [1]

Do not write in the margin.

Do not write in the margin.

37 An electric iron is used to remove wrinkles of the cloth. Water is added into a holding tank in the iron to make the process more efficient. When the electric iron is heated up, white mist can be seen coming through small holes at the bottom as shown below. The white mist caused a wet patch on the cloth.

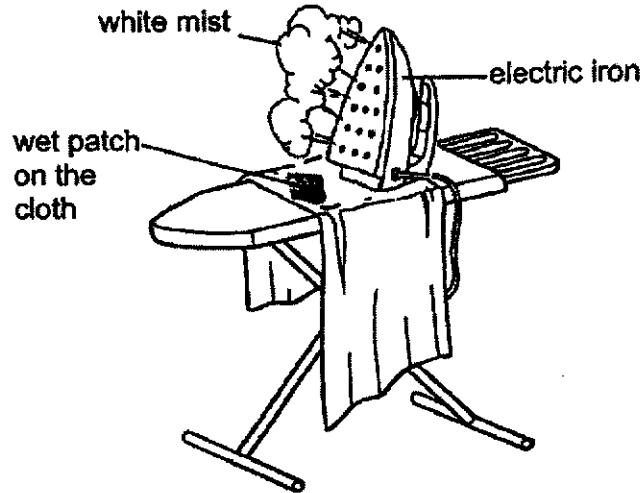

Do not write in the margin.

Do not write in the margin.

(a) What is the white mist? [1]

(b) Explain how the mist is formed. [2]

(c) As the mist is sprayed on cloth, wet patches can be seen. But after ironing, the wet patch on the cloth disappears. Explain why. [1]

Do not write in the margin.

38 The diagram below shows an ant. The shell of the ant prevents it from drowning in water.

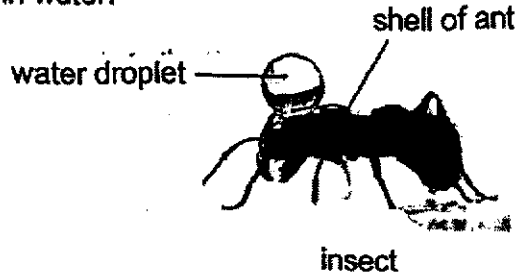

(a) What is the property of the shell that allows the ant to perform this function described? [1]

David wanted to find out if ants can use the sense of sight to identify colours to detect the presence of food. He made a structure as shown below. From one end the ants will crawl through the bridge to reach the food.

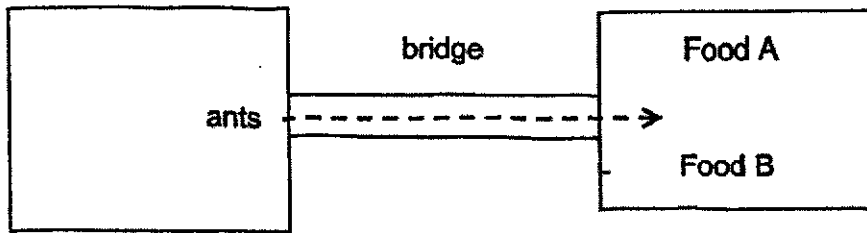

He had four types of food as shown below:

- A. Blue colour with no sweet smell
- B. Yellow colour with no sweet smell
- C. Yellow colour with sweet smell
- D. Blue colour with sweet smell

(b) David used food types, A and B, for his experiment. Explain why. [1]

(c) What should David do to ensure that the results are reliable? [1]

Do not write in the margin.

Do not write in the margin.

Do not write in the margin.

39 Jenny prepared a set-up that works like a thermometer. She added some coloured water into a flask with a glass tube. She made some markings on the glass tube to indicate the temperature.

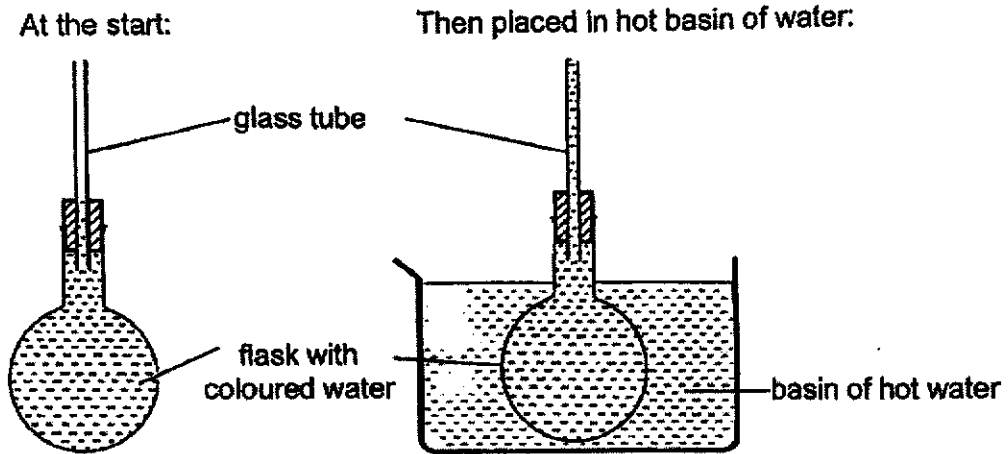

Jenny placed the set-up into a basin of hot water. She observed that the coloured water in the glass tube decreased slightly before it started to increase. Explain why it decrease and then increase. [2]

Do not write in the margin.

Do not write in the margin.

Decrease : _____

Increase: _____

Do not write in the margin.

- 40 The diagram below shows a machine that is used to demolish buildings. The metal ball swings and hit the building to break it. The higher the ball swings, the greater the damage done.

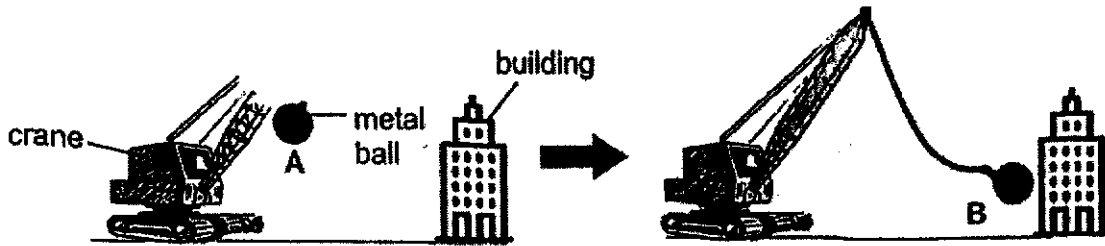

- (a) The metal ball is pulled backwards before it is released to hit the building. Fill in the boxes below to show the energy conversion as the metal ball is swung from positions A to B. [2]

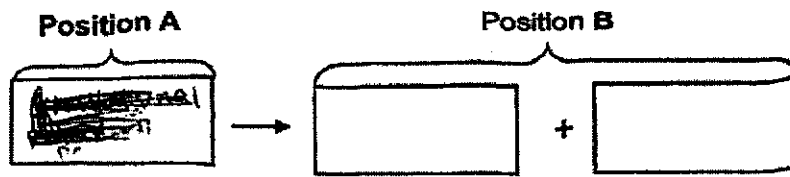

- (b) Explain how swinging the ball higher will cause more damage to the building. [2]

- (c) Other than swinging the ball higher, what change can be made to the ball to cause more damage to the building? [1]

Do not write in the margin.

Do not write in the margin.

Do not write in the margin.

- 41 Tim attended an archery lesson. He was taught how to use the bow and arrow.

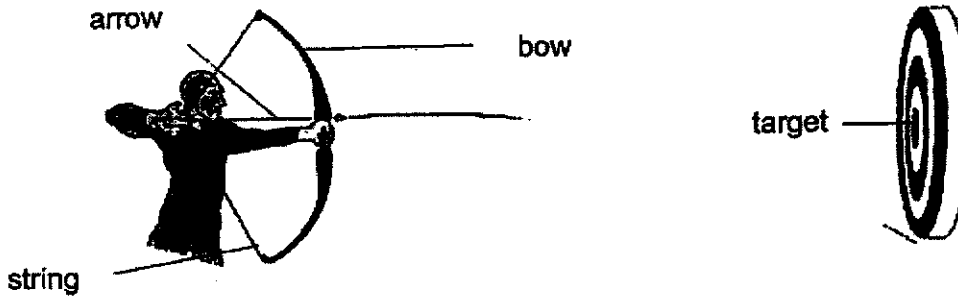

The arrow did not hit the target.

- (a) What must Tim do to hit the target without moving from where he is standing or the target position? [1]

- (b) State the force(s) acting on the arrow as it is moving towards the target. [1]

- (c) His trainer told him that the bow cannot be stretched without an arrow. What would happen to the bow if he stretched it without an arrow? Explain in terms of energy. [2]

Do not write in the margin.

Do not write in the margin.

End of Booklet B

Do not write in the margin.

SCHOOL : ROSYTH PRIMARY SCHOOL
LEVEL : PRIMARY 6
SUBJECT : SCIENCE
TERM : 2022 PRELIM

SECTION A

Q1	Q2	Q3	Q4	Q5	Q6	Q7	Q8	Q9	Q10
3	4	4	4	3	2	4	4	3	3
Q11	Q12	Q13	Q14	Q15	Q16	Q17	Q18	Q19	Q20
1	2	2	1	3	4	3	4	4	3
Q21	Q22	Q23	Q24	Q25	Q26	Q27	Q28		
2	1	3	2	3	3	3	1		

29a	Yes. P and S have six legs. All insects have six legs
29b	Any two Need air, food and water to survive (complete answer then award 1m) Reproduce ,Grow ,Die
30a	←
30b	<u>Water enters the water carrying tubes in the stem. Water from the water carrying tubes is transported to the leaves and lost /escapes /released through the stomata/leaves as water vapour into the surrounding air.</u>
31a	Circulatory system
31b	Respiratory system takes in oxygen and absorbs it into the bloodstream (1m) Or Nose takes in oxygen/air and is transported to the lungs where oxygen is absorbed into the bloodstream AND Circulatory system transports oxygen to the muscles (1m) Or (The oxygen-rich blood flows to the heart.) Heart pumps the blood rich in oxygen to the muscles.
31c	<u>Less volume of blood flow per minute flows to the digestive system (½) so less digested food is absorbed into bloodstream (½) and thus less digested food is transported to the muscles.</u> OR <u>Blood flow to the digestive system at a slower rate (½) thus the small intestine receives less oxygen for respiration. Less energy is released causing less food to be digested. (½)</u>
32a	Hairs help the seeds to be <u>dispersed further from parent plants to avoid /prevent overcrowding</u> so that young plants can grow well OR Young plants can grow well <u>without competing for sunlight, water, space and mineral salts/nutrients (at least 2; must include sunlight) as the seeds are scattered away from the parent plant.</u>

32b	<p>Fruit B. The young plant is <u>randomly scattered / different directions/in all directions/no particular pattern/scattered all over the place (1/2m)</u> from the parent plant thus it should be <u>fruit B which has stiff hair that will hook onto the fur(1/2m)</u></p> <p>The <u>dispersal of plant is not affected by the wind direction / is also present in the opposite direction of the wind(1/2)</u> and since B has stiff hair which allows it to stick onto animal bodies for dispersal(1/2).</p>
33a	More carbon dioxide traps more heat
33b	<p>With <u>more carbon dioxide the rate of photosynthesis is faster to produce more food/sugar to grow more.</u></p> <p>OR</p> <p>As the <u>temperature of surroundings increases, the rate of photosynthesis increases to make more food.</u></p>
33c	<u>More) raindrops fall on more leaves which will gain heat from the surrounding air and evaporate to form water vapour</u>
34a	<p>Plant caterpillar blackbird owl OR</p> <p>Plant snail blackbird owl</p>
34b	<p>An increase in snail population results in <u>more food for the blackbird</u> so the <u>population of blackbird will increase which will feed on more caterpillar</u></p> <p>OR</p> <p>An increase in snail population results in a <u>decrease in plant population. With less food, the population of caterpillar will decrease</u></p>
34c	<p>Snails' waste /snail's dead body is <u>broken down/decomposed</u> into simple substances for plants to absorb</p> <p>Snails help to loosen the soil so more water can reach roots of plants</p> <p>Snails eat dead matter and speed up the rate of decomposition to enrich the soil.</p> <p>the snails help to pollinate the flowers when it eats the plants</p>
35a	<p>20°C</p> <p>*must write unit*</p> <p>no units → 0m</p>

35b	As the number of stands increase, the temperature of water in the apparatus decreases <u>faster</u> . <u>the greater the number of stands, the lower the temperature of water in the apparatus.</u>
35c	Behavioural
35d	Bird F stands on one leg to ensure <u>less surface area in contact with the cooler water (1/2)</u> so that <u>less heat is lost from its body /leg to the water (1/2)</u>
36a	<div style="text-align: center;"> <div style="border: 1px solid black; padding: 5px; width: fit-content; margin: 0 auto;">Electrical Conductivity of Material</div> <div style="display: flex; justify-content: space-around; margin-top: 10px;"> <div style="border: 1px solid black; padding: 5px; width: 40%;"> <p style="text-align: center;">Electrical conductors*</p> <div style="border: 1px solid black; padding: 5px; text-align: center; margin-top: 5px;">W, Y, Z</div> </div> <div style="border: 1px solid black; padding: 5px; width: 40%;"> <p style="text-align: center;">Electrical insulators#</p> <div style="border: 1px solid black; padding: 5px; text-align: center; margin-top: 5px;">X</div> </div> </div> </div>
36bi	Circuit P : parallel (1m) Circuit Q: series. (1m)
36bil	The <u>current flowing in P remains the same</u> while current flowing <u>in Q decreases</u> . (1m)
37a	Water droplets/Water
37b	<u>Water (in the iron/holding tank) gains heat / and evaporate to form water vapour.</u> [1] This water vapour is released out of the iron and <u>loses heat to the cooler surrounding air</u> and condenses into mist/water droplets. [1]
37c	The <u>water droplets</u> on the shirt/wet patch <u>gains heat from the iron/hot cloth and evaporates</u> into water vapour. [1]
38a	Waterproof
38b	MUST mention colour AND smell <u>Colours are different to find out if the ants can use the sense of sight to use color to find its food.</u>

	<u>AND No smell to ensure that colour is the only variable affecting the ants attraction towards the food</u>
38c	Repeat the experiment and take the average repeat the experiment with a few more ants repeat the experiment to make sure the results are consistent.
39	Decrease: Flask <u>gained heat (from hot water)</u> and <u>expanded</u> (before the water expanded). Increase: Coloured water <u>gained heat (from hot water)</u> and <u>expanded</u> (more than the flask)
40a	(Gravitational) potential energy (1m) kinetic energy + sound/heat (1m)
40b	When the ball is higher, it will have <u>more gravitational potential energy (0.5)</u> that can be converted to <u>more kinetic energy (0.5)</u> This would result in <u>greater impact/more force /speed(1)</u> on the structure.
40c	Change the ball to a <u>heavier/bigger/denser</u> one.
41a	Raise the bow /Move the bow higher/steeper angle
41b	Friction, gravitational force Accept: Frictional force/ gravity
41c	Bow will be damaged /broken /break (½) <u>When the string of the bow is stretched it has potential energy (1/2) which is converted to kinetic energy (when released) (1/2) which will be transferred to the bow (1/2) and damage it.</u>

