

**RAFFLES GIRLS' PRIMARY SCHOOL
WEIGHTED ASSESSMENT 1 2023
MATHEMATICS
PRIMARY 6**

Name: _____ ()

Form Class: P6 _____

Math Teacher: _____

Date: 28 February 2023

Duration: 50 minutes

Your Total Score (Out of 30 marks)	
Parent's Signature	

INSTRUCTIONS TO CANDIDATES

1. Do not turn over this page until you are told to do so.
2. Follow all instructions carefully.
3. Answer **ALL** questions and show all working clearly.
4. The use of calculator is allowed for this paper.

Questions 1 and 2 carry 1 mark each and Questions 3 to 10 carry 2 marks each.
Show your working clearly and write your answers in the spaces provided.
For questions which require units, give your answers in the units stated.

[18 marks]

1. What is the missing number in the box?

$$3\ 000\ 000 + 10\ 000 + \boxed{} + 8 = 3\ 014\ 008$$

Ans: _____ [1]

2. Use all the digits 4, 5, 6, 8 to form the greatest number between 5 000 and 6 000.

Ans: _____ [1]

3. How many halves are there in $5\frac{1}{2}$?

Ans: _____ [2]

4. Arrange these fractions from the smallest to the largest.

$$2\frac{1}{2}, \frac{13}{5}, 2\frac{3}{7}$$

Ans: _____, _____, _____ [2]
Smallest Largest

5. Mr Ravi bought some boxes of chocolates. Each box contained 12 chocolates. The total number of chocolates Mr Ravi bought was more than 50 but fewer than 100. Mr Ravi ate 7 chocolates and gave the rest equally to each of his 5 children. How many chocolates did each child get?

Ans: _____ [2]

6. Fill in the boxes with the correct mathematical symbols. Each symbol can only be used once.

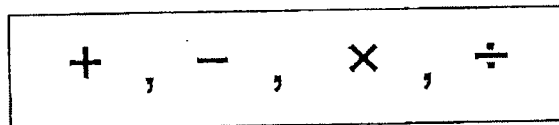

$$56 \square 4 + 3 \square 8 = 38 \quad [2]$$

7. Eva spent $\frac{1}{7}$ of her savings on a gift for her brother. Then, she spent $\frac{2}{3}$ of the remainder on a school bag. What fraction of her savings had she left?
Give your answer in the simplest form.

Ans: _____ [2]

8. Terry had 3 times as many \$2-notes as \$5-notes. He had \$385 altogether. How many \$5-notes did Terry have?

Ans: _____ [2]

9. Aminah had an equal number of sunflowers and roses. She gave away $\frac{3}{5}$ of the sunflowers and some roses. In the end, she was left with $\frac{1}{4}$ of the total number of flowers. What fraction of the roses did she give away?

Ans: _____ [2]

10. There are some pink, black and green beads in a container. $\frac{2}{5}$ of the beads are pink. There are more black beads than green beads.

Each of the statements below is either true, false or not possible to tell from the information given. For each statement, put a tick(✓) to indicate your answer.

Statement	True	False	Not possible to tell
(a) There are fewer green beads than pink beads.			
(b) If $\frac{1}{8}$ of the pink beads are used, there will be more black beads than pink beads left.			

[2]

For questions 11 to 13, show your working clearly and write your answers in the spaces provided. The number of marks available is shown in the brackets [] at the end of each question or part-question. [12 marks]

11. Tim and Jerry were paid a total of \$8568 for selling tickets. Tim was paid \$5304 more than Jerry.

(a) How much was Tim paid for selling the tickets?

(b) Tim and Jerry were paid based on the number of tickets they sold. Tim sold 3 times as many tickets as Jerry. Tim was paid \$5 more than Jerry for selling each ticket. How many tickets did Tim sell?

Ans: (a) _____ [2]

(b) _____ [3]

12. Ruth needs 90 pieces of ribbons each of length $\frac{4}{5}$ m to decorate a room. Ribbon is sold in rolls of 10 m each.

- (a) What is the maximum number of pieces of ribbon she can get from a roll of 10 m?
- (b) What is the least number of rolls of ribbon that Ruth needs to buy?

Ans: (a) _____ [2]

~~(a)~~ _____ [2]
(b)

13. Ahmad used sticks to form the following figures.

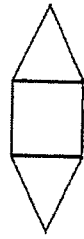

Figure 1

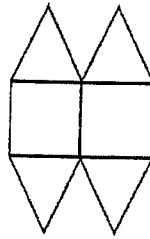

Figure 2

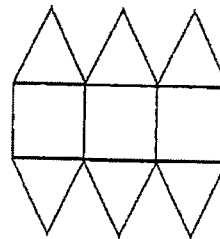

Figure 3

(a) The table shows the number of triangles and sticks for the first three figures. Complete the table for Figure 4.

Figure Number	Number of triangles	Number of sticks
1	2	8
2	4	15
3	6	22
4	()	()

[1]

(b) A figure in the pattern has a total of 2507 sticks.
What is the Figure Number?

Ans: (b) Figure _____ [2]

END OF PAPER

SCHOOL : RAFFLES GIRLS' PRIMARY SCHOOL

LEVEL : PRIMARY 6

SUBJECT : MATH

TERM : WA1 2023

1) 4000

2) 5864

3) $5\frac{1}{2} \div \frac{1}{2} = 11$

4) $2\frac{3}{7}$, $2\frac{1}{2}$, $\frac{13}{5}$

5) 13

6) $56 \div 4 + 3 \times 8 = 38$

7) $\frac{2}{7}$

8) $6U + 5U = 385$

$$U = 385 \div 11$$

$$U = 35$$

9) $10U - 8U = 2U$

$$20U - 2U = 18U$$

$$\frac{18}{20} = \frac{9}{10}$$

10) a) True

b) Not possible to tell

$$11)a) 8568 - 5304 = 3264$$

$$3264 \div 2 = 1632$$

$$1632 + 5304 = \$6936$$

$$b) 6936 \div 3 = 2312$$

$$2312 - 1632 = 680$$

$$680 \div 5 = 136$$

$$136 \times 3 = 408$$

$$12)a) 12$$

$$b) 90 \div 12 = 7.5$$

$$7.5 \sim 8$$

$$13)a) 8, 29$$

$$b) 2507 - 8 = 2499$$

$$2499 \div 7 = 357$$

$$357 + 1 = 358$$



Rosyth School
Term Assessment 2023 (Term 1)
MATHEMATICS
Primary 6
Paper 1

Name : _____ ()

Class : Pr 6 - _____

Date : 21st February 2023

Parent's Signature: _____

Total Time for Booklets A and B : 25 min

Booklet A

Instructions to Pupils:

1. Do not turn over this page until you are told to do so.
2. Follow all instructions carefully.
3. Answer all questions.
4. Use a dark blue or black ballpoint pen to write your answers in the space provided for each question.
5. Do not use correction fluid/tape or highlighters.
6. The use of a calculator is not allowed.

Questions	Maximum Mark	Marks Obtained
Q 1 – 5	5	

* This paper consists of 5 printed pages altogether (including the cover page).

Questions 1 to 5 carry 1 mark each. For each question, four options are given. One of them is the correct answer. Make your choice (1, 2, 3 or 4) and write your answer in the brackets provided.

All diagrams in this paper are not drawn to scale unless stated otherwise.

(5 marks)

1. In the figure, WX is the base of the triangle WXY. Which line represents its height?

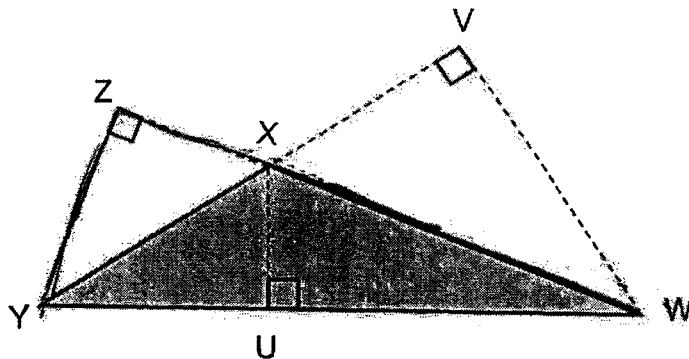

- (1) UX
 (2) VW
 (3) XY
 (4) YZ

()

2. Kim has some red, blue and green beads. The ratio of the number of red beads to the number of blue beads is 1 : 2. The number of green beads to the total number of blue and red beads is 1 : 4. What is the ratio of the number of red beads to the number of blue beads to the number of green beads?

- (1) 1 : 2 : 1
 (2) 1 : 2 : 4
 (3) 4 : 8 : 3
 (4) 8 : 4 : 3

()

3. The figure below is made up of a quadrant and 2 identical semicircles.

Find the perimeter of the figure. (Take $\pi = \frac{22}{7}$)

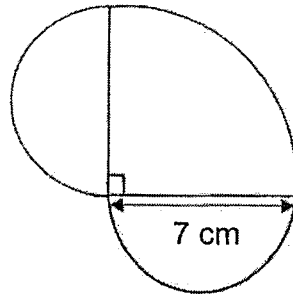

- (1) 27.5 cm
- (2) 33 cm
- (3) 44 cm
- (4) 49.5 cm

4. The line graph below shows the number of cars sold in the showroom from June to November.

What was the percentage decrease in sale from June to July?

Number of cars sold from June to November

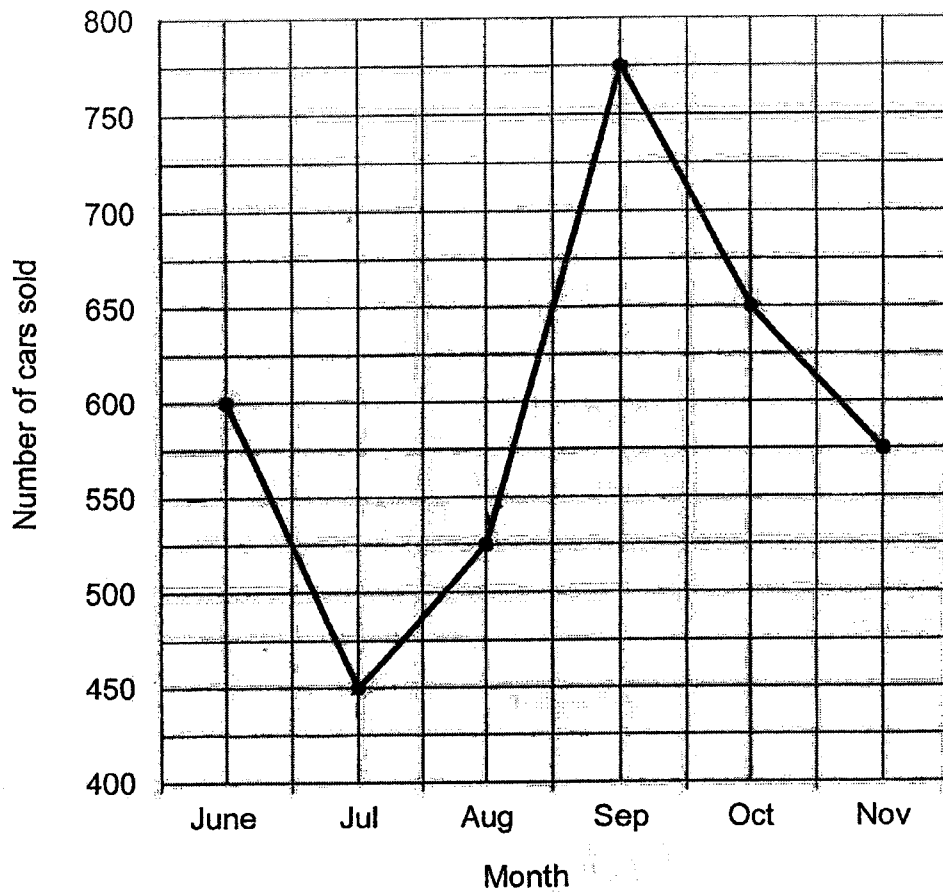

- (1) 25%
(2) $33\frac{1}{3}\%$
(3) 75%
(4) 150%

5. In the figure below, ABCD is a trapezium. AD is parallel to BC and $BC = CD$. $\angle ABD = 76^\circ$ and $\angle BCD = 112^\circ$. Find $\angle BAD$.

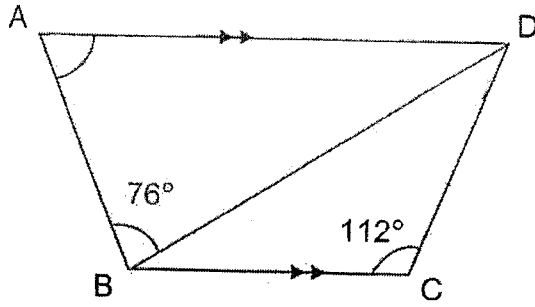

- (1) 34°
 (2) 68°
 (3) 70°
 (4) 104°

()

