



Rosyth School
Mid-Year Examination 2019
MATHEMATICS
Paper 1
Primary 6

Name: _____

Register No. _____

Class: Pr 6 - _____

Date: 15 May 2019

Parent's Signature: _____

Total Time for Booklets A and B : 1 hour

Booklet A

Instructions to Pupils:

1. Do not open this booklet until you are told to do so.
2. Follow all instructions carefully.
3. Shade your answers in the Optical Answer Sheet (OAS) provided.
4. You are **not** allowed to use a calculator.
5. Answer all questions.

Section	Maximum Mark	Marks Obtained
Paper 1 (Booklet A)	20	

* This booklet consists of **8** pages (including this cover page)

This paper is not to be reproduced in part or whole without the permission of the Principal.
Questions 1 to 10 carry 1 mark each. Questions 11 to 15 carry 2 marks each.
For each question, four options are given. One of them is the correct answer.
Make your choice (1, 2, 3 or 4). Shade the oval (1, 2, 3 or 4) on the Optical Answer Sheet.

All diagrams in this paper are not drawn to scale unless stated otherwise.
(20 marks)

1. Part of a scale is shown below. What is the value of the reading at A?

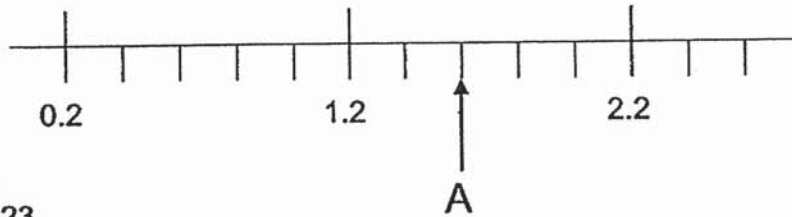

- (1) 1.23
- (2) 1.26
- (3) 1.5
- (4) 1.6

2. Which of the following fractions is the largest?

- (1) $\frac{3}{8}$
- (2) $\frac{3}{4}$
- (3) $\frac{3}{11}$
- (4) $\frac{3}{5}$

3. In the diagram below, the letters U, N, I and T are drawn on a square grid.

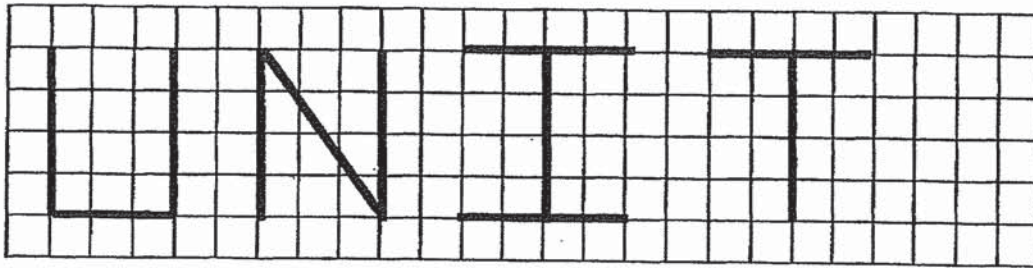

Which letters have both parallel and perpendicular lines?

- (1) U and N only
 - (2) U and I only
 - (3) N and I only
 - (4) I and T only
4. The table below shows the time taken by 4 runners in a 400 m competition.

Swimmer	Time taken (seconds)
Amelia	83.2
Banu	81.8
Caden	92.9
Decaf	92.1

Who came in 3rd in the competition?

- (1) Amelia
- (2) Banu
- (3) Caden
- (4) Decaf

5. In the figure below, ABCD is a rhombus and BEC is an equilateral triangle. Find $\angle ABE$.

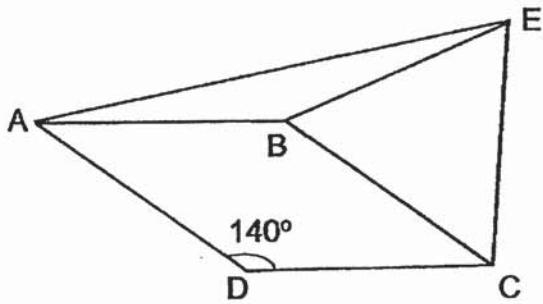

- (1) 40°
 (2) 140°
 (3) 160°
 (4) 200°
6. The pie chart represents the favorite colour chosen by a group of students. Half of them chose red and blue. How many students chose green?

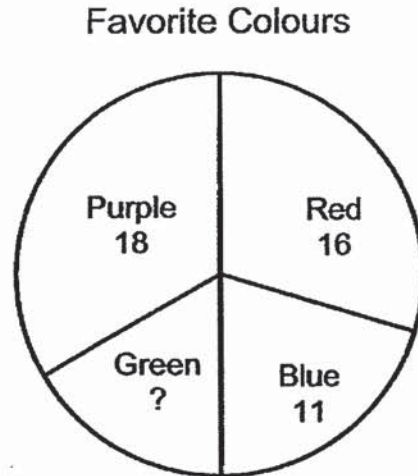

- (1) 7
 (2) 9
 (3) 18
 (4) 25

7. Claire had \$6. She bought 2 identical hair clips and had \$y left. What was the cost of each hair clip?

(1) $\$(3 - 2y)$

(2) $\$(6 - \frac{y}{2})$

(3) $\$(6 - 2y)$

(4) $\$(\frac{6-y}{2})$

8. Alynna has 70 beads. 14 are red and the rest are blue. What is the ratio of the number of red beads to the number of blue beads?

(1) 1 : 4

(2) 1 : 5

(3) 4 : 1

(4) 4 : 5

9. The coffee shop is 500 m from Han's house. Han took 10 minutes to walk to the coffee shop and back to his house. What was Han's average walking speed?

(1) 25 m/ min

(2) 50 m/ min

(3) 100 m/ min

(4) 250 m/ min

10. A supermarket sold 50 oranges for \$20. How much did each orange cost?

- (1) 25¢
- (2) 40¢
- (3) 50¢
- (4) 4¢

11. Boston gave $\frac{1}{6}$ of his salary to his mother and spent $\frac{1}{3}$ of the remainder. What fraction of his salary did he have left?

- (1) $\frac{1}{18}$
- (2) $\frac{1}{2}$
- (3) $\frac{5}{9}$
- (4) $\frac{2}{3}$

12. The parcel rates to two countries is shown below.

Mass Step	China	United States
First 1 kg	\$4	\$8
Every additional 250 g	\$1.50	\$5

Alicia sent a parcel weighing 1.9 kg to China and a parcel weighing 850 g to the United States. How much did she pay altogether?

- (1) \$18
- (2) \$18.50
- (3) \$20
- (4) \$22

(Go on to the next page)

13. The figure below is made up of a triangle, ABC and a trapezium, CDEF. The line AB is parallel to the line DE. Find $\angle CFE$.

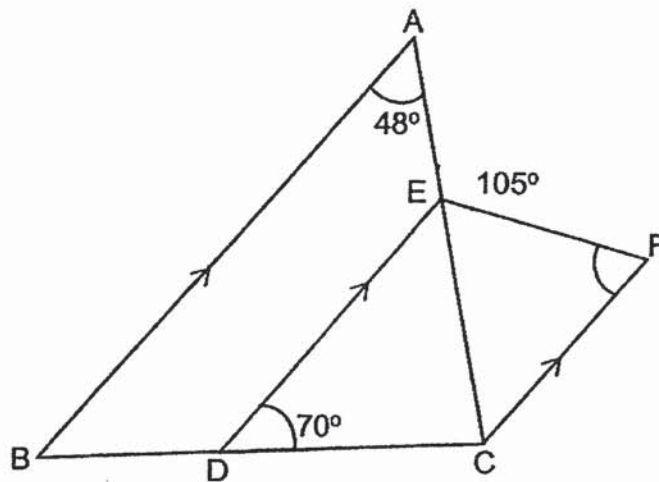

- (1) 52.5°
 (2) 57°
 (3) 61°
 (4) 70°
14. Kieren has 2 rectangular boxes A and B. Both Box A and Box B have square bases of different sizes. The length of the square base of Box A is twice the length of the square base of box B. Both boxes have the same height.
- He packed 192 identical cubes exactly into the larger box. How many such cubes can be packed exactly into the smaller box?
- (1) 12
 (2) 24
 (3) 36
 (4) 48

15. The figure shown below is formed by 3 identical quadrants of radius 7 cm. Find the perimeter of the figure. Take $\pi = \frac{22}{7}$

- (1) 47 cm
- (2) 58 cm
- (3) 115.5 cm
- (4) 154 cm

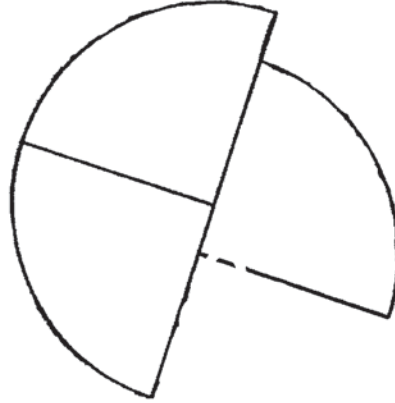



Rosyth School
Mid-Year Examination 2019
MATHEMATICS
Paper 1
Primary 6

Name: _____ Register No. _____

Class: Pr 6 - _____ Group: _____

Date: 15 May 2019 Parent's Signature: _____

Total Time for Booklets A and B : 1 hour

Booklet B

Instructions to Pupils:

1. Do not open this booklet until you are told to do so.
2. Follow all instructions carefully.
3. You are **not** allowed to use a calculator.
4. Write your answers in the booklet.
5. Answer all questions.

Section	Maximum Mark	Marks Obtained
Paper 1 (Booklet B)	25	

* This booklet consists of **8** pages (including this cover page).

Questions 16 to 20 carry 1 mark each. Write your answers in the spaces provided. For questions which require units, give your answers in the units stated.

Do not write in this space

All diagrams in this paper are not drawn to scale unless stated otherwise.
(5 marks)

16. Find the value of $4 \times (18 - 5) + 36 \div 4$.

Ans: _____

17. How many eighths are there in $1\frac{1}{4}$?

Ans: _____

18. In the figure below, find $\angle a$.

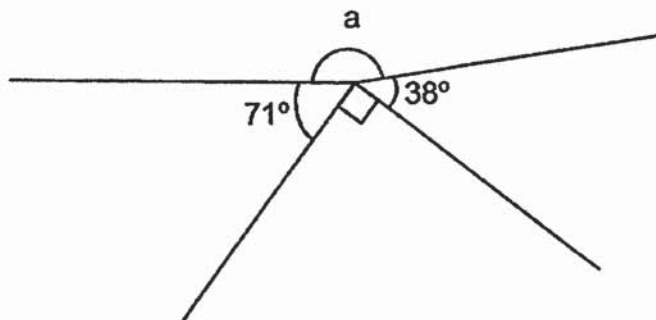

Ans: _____ °

19. Edward collected 40 kg of paper for recycling this month. Last month, he collected 25 kg of paper. What is the percentage increase in paper he collected this month?

Do not write
in this space

Ans: _____ %

20. Draw a line of symmetry in the figure shown below.

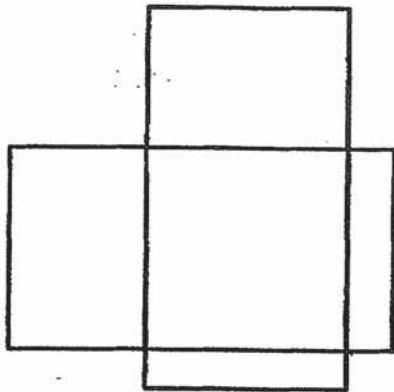

Questions 21 to 30 carry 2 marks each. Show your workings clearly in the space provided for each question and write your answers in the spaces provided. For questions which require units, give your answers in the units stated.

Do not write
in this space

All diagrams in this paper are not drawn to scale unless stated otherwise.
(20 marks)

21. Jane bought 36 pencils and 45 chocolates for Children's Day. Each pupil received the same number of pencils and chocolates. What is the maximum number of pupils who can receive the pencils and chocolates?

Ans: _____

22. Ming San has just enough money to buy 15 apples. If the price of each apple is reduced by \$0.20, she will be able to buy another 6 apples with the same amount of money. What is the original price of each apple?

Ans: \$ _____

23. At a cinema, the ratio of the number of adults to the number of children was 5 : 2. The ratio of the number of men to the number of women was 1 : 2. What was the ratio of the number of women to the number of children? Express your answer in the simplest form.

Ans: _____

24. A rectangular piece of paper was folded as shown below. Find $\angle x$.

Do not write
in this space

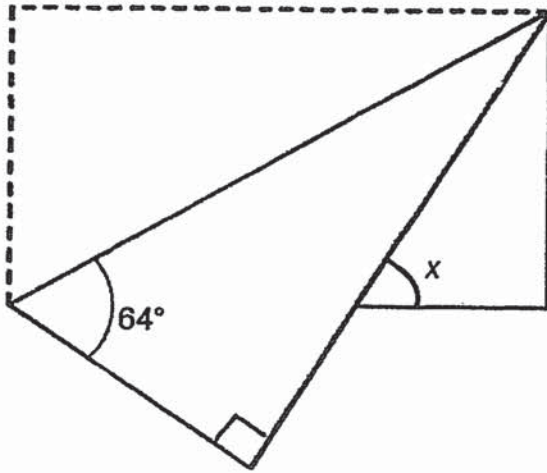

Ans: _____ °



25. Three pupils spent the same amount of money to buy an identical book. Gabriel used $\frac{1}{7}$ of his money. Paul used $\frac{2}{5}$ of his money and James used $\frac{3}{4}$ of his money. They had a total of \$150 at first.

Statement	True	False	Not possible to tell
a) The sum of Gabriel's and Paul's money is twice as much as James.			
b) Each of them spent \$50 to buy the book.			

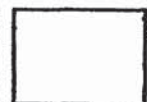

26. At 2 p.m., Zac started filling an empty tank with water. The line graph shows the volume of water in the tank from 2 p.m. to 3.20 p.m.

Do not write in this space

Volume of water in tank

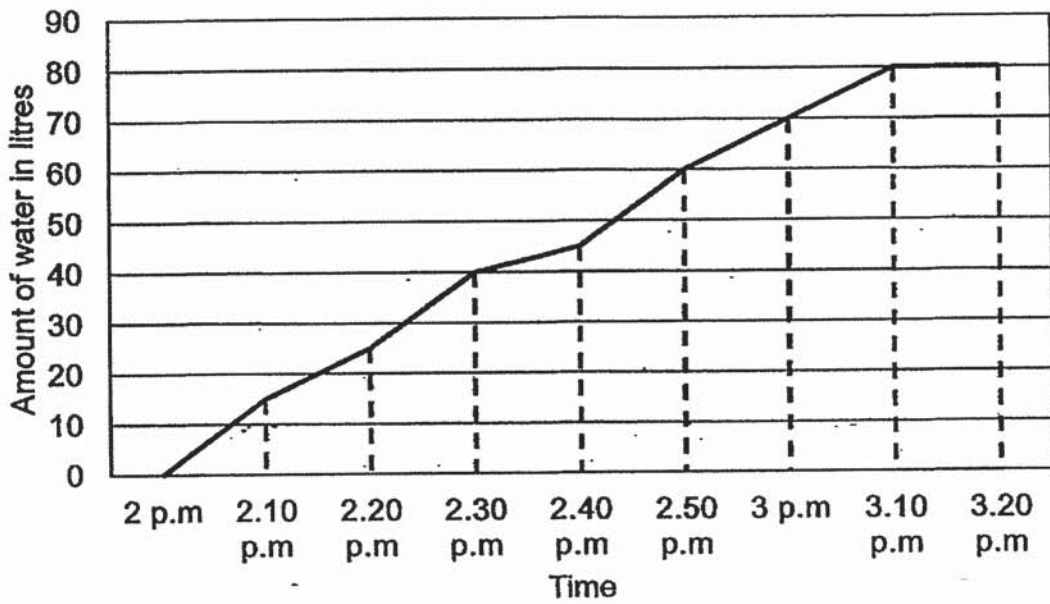

- (a) What is the volume of the tank?
- (b) At what time was $\frac{3}{4}$ of the tank filled with water?

Ans: (a) _____ l

Ans: (b) _____ p.m.

27. Find the value of $\frac{8r}{3} - 2r + 1$ when $r = 4$.
Express your answer as a mixed number in the simplest form.

Ans: _____

28. In the figure below, PQRS is a rectangle and PQT is a triangle. The length of PQ is 13 cm. The difference between the perimeter of the unshaded figure PTQRS and the perimeter of triangle PQT is 16 cm. Find the area of rectangle PQRS.

Do not write
in this space

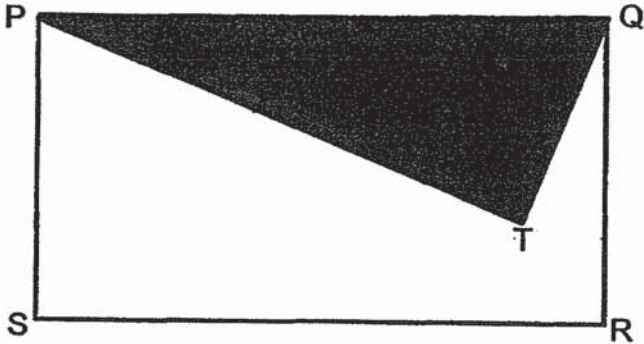

Ans: _____ cm²

29. A student use a calculator to divide a number by one thousand. He made a mistake and pressed 2 fewer zeroes. He obtained an answer of 23.3. What should the correct answer be?

Ans: _____

30. Chloe received a pocket money of \$20 each week. The bar graph shows the amount she spent over 5 weeks.

Do not write
in this space

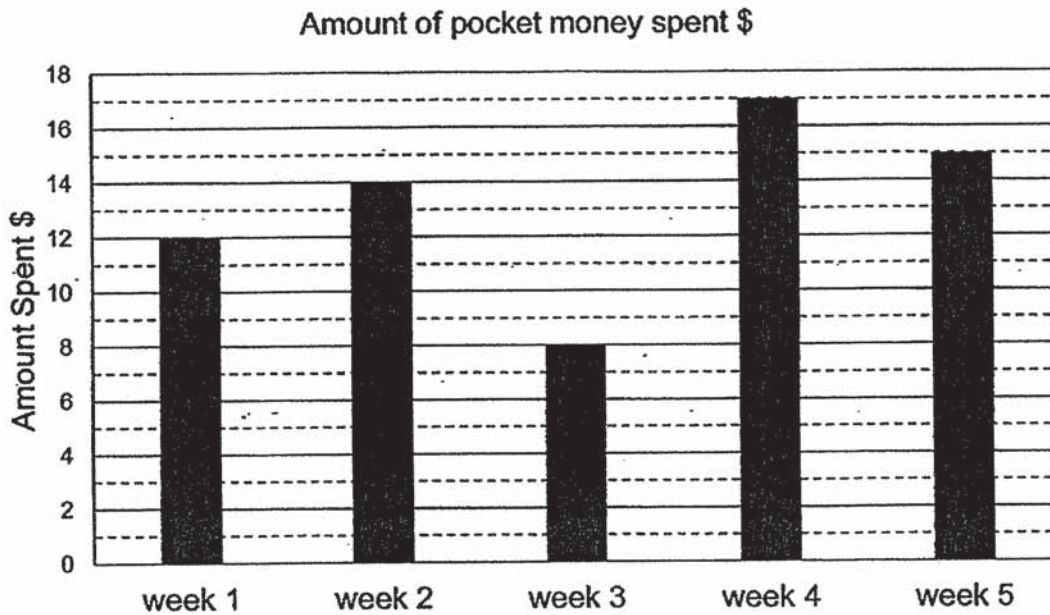

- (a) In which week did Chloe save the most amount of money?
- (b) What was the average amount of money Chloe spent over the 5 weeks?

Ans: (a) week _____

Ans: (b) \$ _____

End of paper
Have you checked your work?



Rosyth School
Mid-Year Examination 2019
MATHEMATICS
Paper 2
Primary 6

Name: _____

Register No. _____

Class: Pr 6 - _____

Date: 15 May 2019

Parent's Signature: _____

Time: 1 h 30 min

Instructions to Pupils:

1. Do not open this booklet until you are told to do so.
2. Follow all instructions carefully.
3. **Show your workings clearly** as marks are awarded for correct working.
4. Write your answers in this booklet.
5. You are allowed to use a calculator.
6. Answer all questions.

Questions	Maximum Mark	Marks Obtained
Q 1 to 5	10	
Q 6 to 17	45	

Section	Maximum Mark	Marks Obtained
Paper 1	45	
Paper 2	55	
Total	100	

*** This booklet consists of 14 pages (including this cover page).**

This paper is not to be reproduced in part or whole without the permission of the Principal. Questions 1 to 5 carry 2 marks each. Show your working clearly in the space provided for each question and write your answers in the spaces provided. For questions which require units, give your answers in the units stated.

Do not write
in this space

(10 marks)

All diagrams in this paper are not drawn to scale unless stated otherwise.

1. Joslyn bought 3 kg of rice. She used $\frac{5}{8}$ of it. How much rice is left? Give your answer in grams.

Ans: _____ g

2. Jeroen finished watching a movie at 8.50 p.m.
The movie was 2 hours 15 minutes long.
At what time did Jeroen start watching the movie?

Ans: _____ p.m.

3. There were 84 red beads and 57 blue beads in a container. Wendy added an equal number of blue and red beads into it. The ratio of the number of red beads to the number of blue beads became 11 : 8.
How many red beads were there in the end?

Ans: _ _ _ _ _ .

4. The cost of 3 pencils and 2 rulers is $\$(5j + 4)$. The cost of a ruler is 50-cents more than a pencil. What is the cost of 1 pencil? Give your answer in terms of j in the simplest form.

Do not write
in this space

Ans: \$ _____

5. Deborah and Alynna started cycling from the same place but in the opposite directions. Deborah cycled at a constant speed of 20 km/h while Alynna cycled at a constant speed of 12 km/h. How far apart will they be after 3 hours?

Ans: _____ km

For Questions 6 to 17, show your working clearly in the space provided for each question and write your answers in the spaces provided. The number of marks available is shown in brackets [] at the end of each question or part-question. For questions which require units, give your answers in the units stated.

Do not write in this space

(45 marks)

All diagrams in this paper are not drawn to scale unless stated otherwise.

6. In the square grid below, AB and BC are straight lines.
- (a) Measure and write down the size of $\angle ABC$.
- (b) Draw two more straight lines to complete a rhombus ABCD. Label Point D.

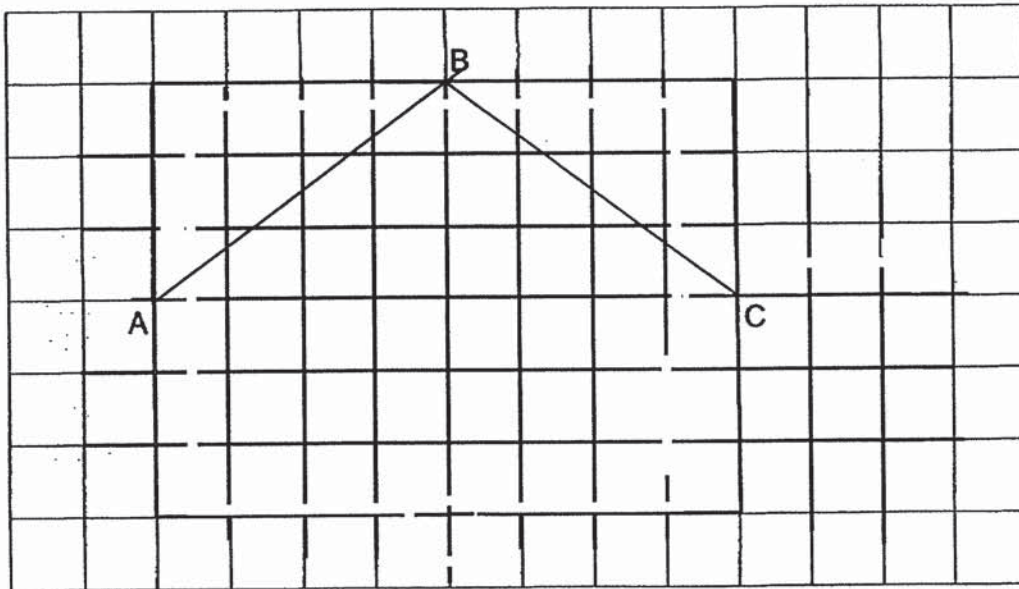

[2]

Ans: (a) _____ [1]

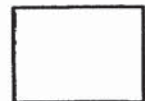

7. The graph below shows the amount collected from the sale of 3 different types of pen in March.

Do not write
in this space

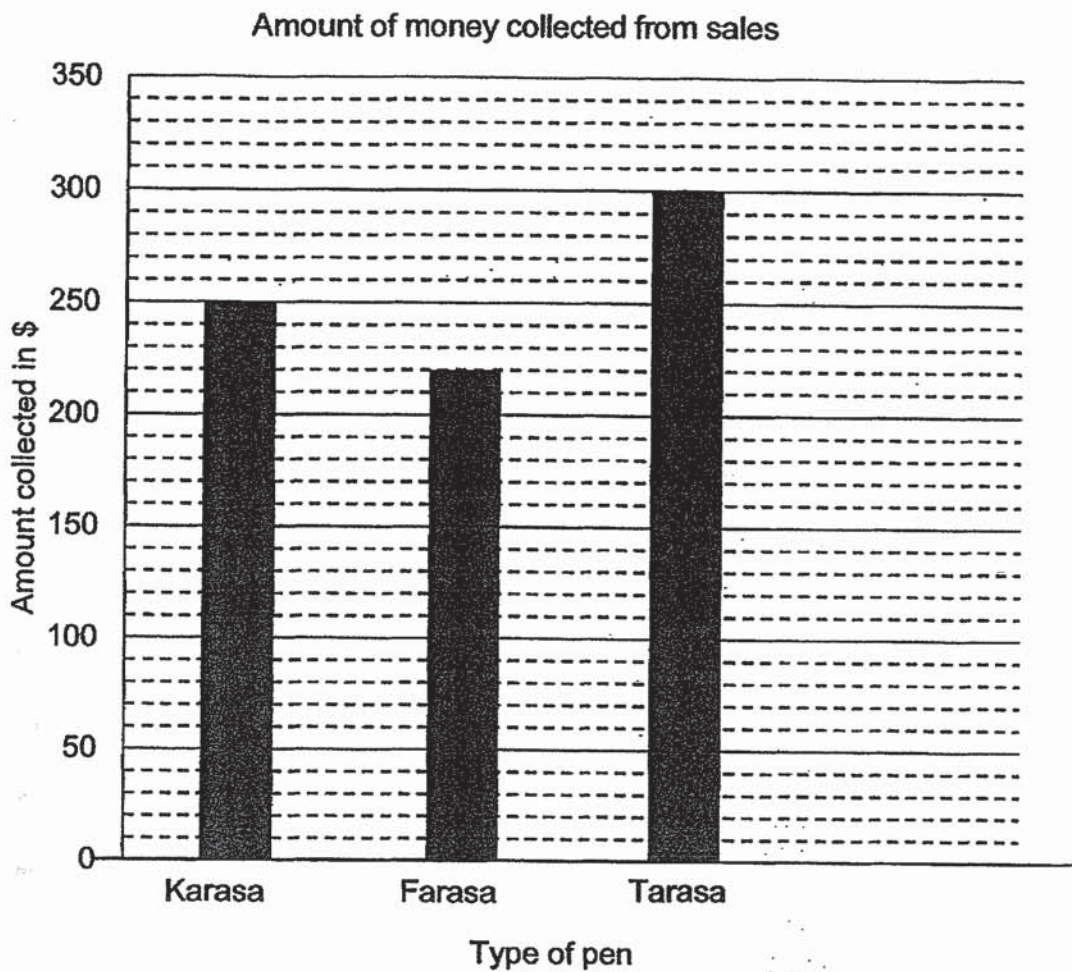

- (a) What was the total amount collected from the sale of the 3 types of pen?
- (b) The cost of a Tarasa pen was 40 cents. How many Tarasa pens were sold in March?

Ans: (a) _____ [1]

Ans: (b) _____ [2]

8. A repeated pattern is formed using the numbers 0, 1, 2, 3 and 4. The first 18 numbers are shown below.

1	4	2	0	3	1	4	2	0	3	1	4	2	0	3	1	4	2
1 st	2 nd	3 rd															18 th

- (a) What is the 103th number?
(b) What is the sum of the first 52 numbers?

Ans: (a) _ _ _ [1]

Ans: (b) _ _ _ [2]

9. Mrs Mok and Mrs Kang were given a certain number of days to sew the same number of cushion covers.
Mrs Mok sewed an average of 24 cushion covers a day, and she took 5 days more.
Mrs Kang sewed an average of 30 cushion covers a day, and she finished sewing her cushions 4 days earlier.
How many days were they given to finish sewing the cushions?

Ans: _ _ _ [3]

Do not write
in this space

10. The figure is made up of 2 squares. Find the shaded area.

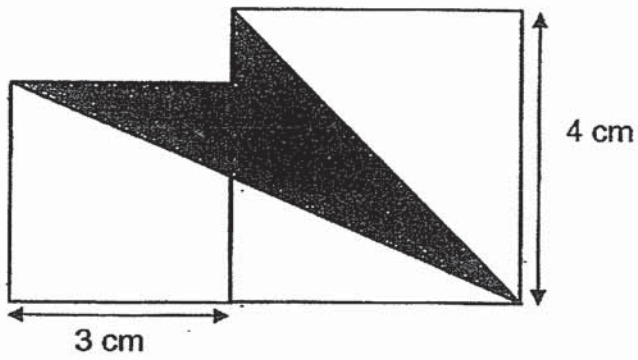

Do not write
in this space

Ans: _____ [3]

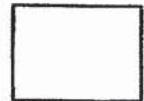

11. The diagram below shows a wooden solid.
 Draw the Front, Top and Side view of the solid in the grids provided.

Do not write
 in this space

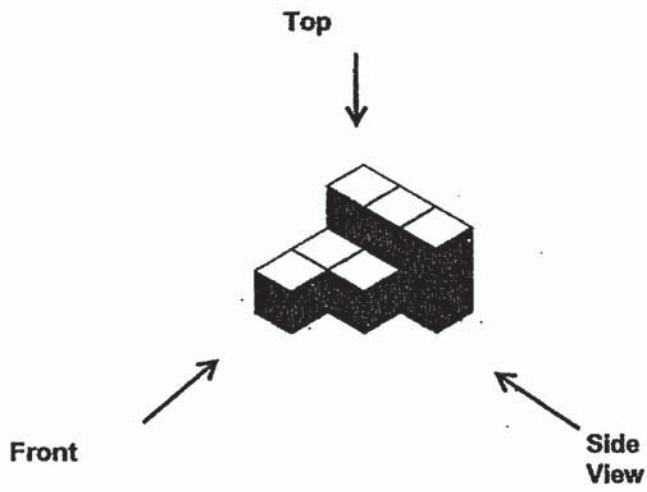

Top view					

Front view					

Side view					

[3]

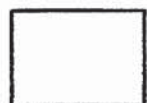

12. Tom and Lily baked a total of 1539 cupcakes. Tom sold thrice as many cupcakes as Lily. In the end, the number of cupcakes Lily had left was 58 more than what she had sold. Lily had twice as many cupcakes left as Tom.

Do not write
in this space

- (a) How many cupcakes did Tom bake at first?
(b) How many cupcakes did Lily sell?

Ans: (a) _____ [2]

Ans: (b) _____ [2]

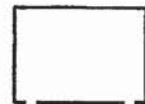

13. Janelle had 2 different rectangular tanks of the same height as shown below. She filled them up with water to the same height.

She filled tank Y with 100.8 litres more water than tank X.

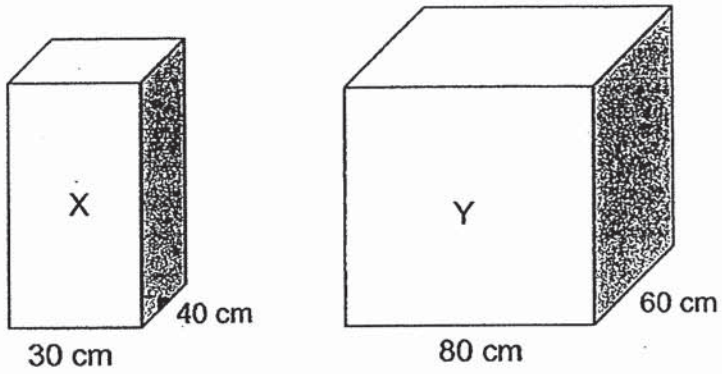

What was the height of the water level in both tanks?

Do not write
in this space

Ans: _____ [4]



14. In the figure below, ABDE is a square and BCD is an equilateral triangle. AF is parallel to BC.

- (a) Find $\angle BAC$.
- (b) Find $\angle AFC$

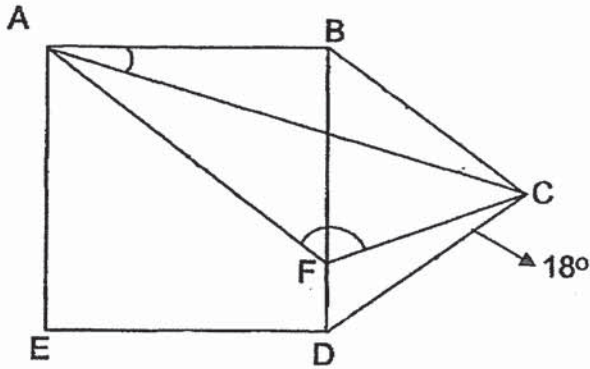

Do not write
in this space

Ans: (a) _____ [2]

Ans: (b) _____ [2]

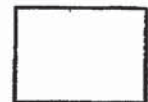

15. Julia bought a dress and a skirt at a discount from a store. She was given a discount of 25% for the dress. For the skirt, a discount was also given. She saved a total of \$31.20.

Do not write
in this space

She paid a total of \$120.80 for the 2 items. She paid \$5.20 more for the dress than the skirt.

- (a) What was the price of the dress without the discount?
(b) What was the percentage discount given for the skirt?

Ans: (a) _____ [2]

Ans: (b) _____ [3]



16. The number of books sold was 4 more than the number of pens sold at a sale. Aaron collected \$1006 altogether.

Do not write
in this space

- (a) How many pens was sold?
- (b) How much money was collected from the sale of his books?

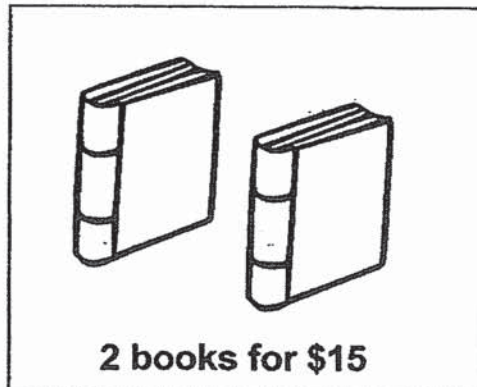
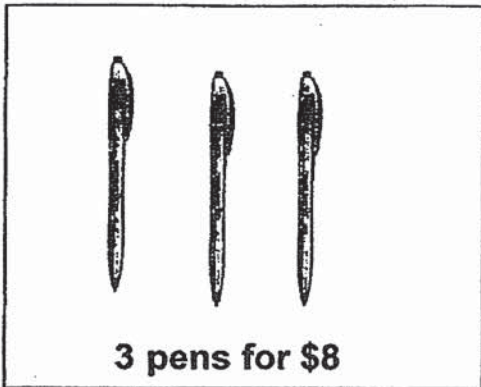

Ans: (a) _____ [2]

Ans: (b) _____ [3]



17. A pattern is set into a big square ABCD shown below. The pattern is made up of identical quadrants of 2 different sizes. Two small squares of side 2 m are used to connect all the quadrants.

Do not write in this space

- (a) What is the perimeter of the big square ABCD?
 - (b) Find the area of the unshaded parts.
- Take $\pi = 3.14$

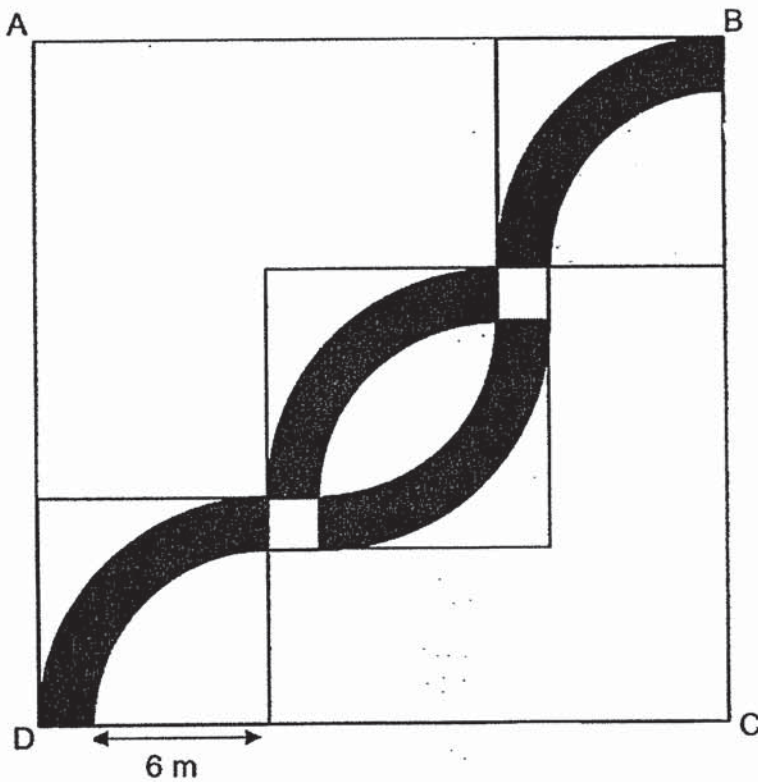

Ans: (a) _____ [2]

Ans: (b) _____ [3]

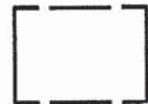

SCHOOL : ROSYTH PRIMARY SCHOOL
 LEVEL : PRIMARY 6
 SUBJECT : MATH
 TERM : 2019 SA1

PAPER 1 BOOKLET A

Q 1	Q2	Q3	Q4	Q5	Q6	Q7	Q8	Q9	Q10
4	2	2	4	3	2	4	1	3	2

Q 11	Q12	Q13	Q14	Q15
3	1	2	4	1

PAPER 1 BOOKLET B

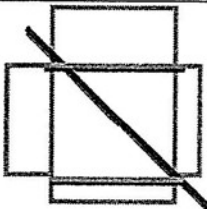
Q16)	$4 \times 13 = 52$ $52 + 9 = 61$	
Q17)	$1\frac{1}{4} = 1\frac{2}{8}$ $1\frac{2}{8} \div \frac{1}{8} = 10$	
Q18)	$90^\circ + 71^\circ = 161^\circ$ $161^\circ + 38^\circ = 199^\circ$ $360^\circ - 199^\circ = 161^\circ$	
Q19)	$\frac{15}{25} \times 100\%$ $= \frac{3}{5} \times 100\%$ $= 60\%$	
Q20)		
Q21)	$36 = 1 \times 36$ $= 2 \times 18$ $= 3 \times 12$ $= 4 \times (9)$	$45 = 1 \times 45$ $= 3 \times 15$ $= 5 \times (9)$ ANS: 9 pupils

Q22)	$15 \times 0.20 = 3$ 6 apples ---- \$3 1 apple ---- $\$3 \div 6 = \0.50 $0.50 + 0.20 = \$0.70$
Q23)	Adults : children men : women 5 : 2 1 : 2 15 : 6 5 : 10 ANS: 5 : 3
Q24)	$90^\circ + 64^\circ = 154^\circ$ $90^\circ - 52^\circ = 38^\circ$ $180^\circ - 154^\circ = 26^\circ$ $38^\circ + 90^\circ = 128^\circ$ $26^\circ \times 2 = 52^\circ$ $180^\circ - 128^\circ = 52^\circ$
Q25)	a)False b)False
Q26)	a)80l b) $\frac{3}{4} \times 80 = 60$ (2.50pm)
Q27)	$8 \times 4 = 32$ $32 \div 3 = 10\frac{2}{3}$ $2 \times 4 = 8$ $10\frac{2}{3} - 8 = 2\frac{2}{3}$ $2\frac{2}{3} + 1 = 3\frac{2}{3}$
Q28)	$16 \div 2 = 8\text{cm}$ $13 \times 8 = 104 \text{ cm}^2$
Q29)	$23.3 \times 10 = 233$ $233 \div 1000 = 0.233$
Q30)	a)week 3 b) $12 + 14 = 26$ $26 + 8 = 34$ $34 + 17 = 51$ $51 + 15 = 66$ $66 \div 5 = 13\frac{1}{5} = \13.20

PAPER 2

Q1)	$1 - \frac{5}{8} = \frac{3}{8}$ $\frac{3}{8} \times 3000 = 1125g$
Q2)	6.35p.m.
Q3)	$11u - 8u = 3u$ $84 - 57 = 27$ $3u = 27$ $1u = 27 \div 3 = 9$

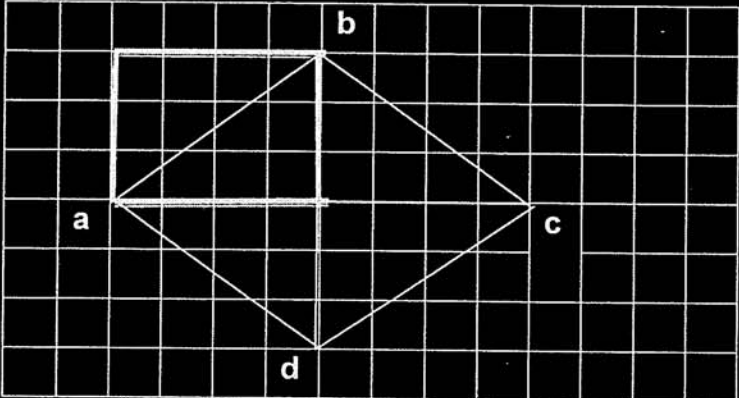
	$11u = 11 \times 9 = 99$ red beads
Q4)	$0.50 \times 2 = 1$ Cost of 5 pencils ----- $\$(5j + 3)$ Cost of 1 pencils $= \frac{\$(5j + 3)}{5}$
Q5)	$20 \times 3 = 60$ $12 \times 3 = 36$ $60 + 36 = 96\text{km}$
Q6)	
Q7)	a) $250 + 220 + 300 = \$770$ b) $\$300$ ----- 30000¢ $30000\text{¢} \div 40\text{¢} = 750$ Tarasa pens
Q8)	a) $103 \div 5 = 20 \text{ R}3$ $\text{R}3$ ----- 2 b) $52 \div 5 = 10 \text{ R}2$ $1 + 4 + 2 + 0 + 3 = 10$ $10 \times 10 = 100$ $100 + 1 + 4 = 105$
Q9)	$24 \times 9 = 216$ $30 - 24 = 6$ $216 \div 6 = 36$ $36 + 4 = 40$ days
Q10)	$3 \times 3 = 9$ $4 \times 4 = 16$ $16 + 9 = 25$ $\frac{1}{2} \times 3 \times (3 + 4) = 10.5$ $\frac{1}{2} \times 4 \times 4 = 8$ $10.5 + 8 = 18.5$ $25 - 18.5 = 6.5\text{cm}^2$

Q11)	<div style="display: flex; justify-content: space-around; text-align: center;"> <div data-bbox="199 224 518 548"> <p>Side view</p> </div> <div data-bbox="526 224 845 548"> <p>Top view</p> </div> <div data-bbox="853 224 1173 548"> <p>Front view</p> </div> </div>
Q12)	<p>Number of cupcake Lily has at first ----- $1u+1u+58$ $=2u+58$</p> $(1u+58) \div 2 = \frac{1}{2}u + 29$ <p>Number of cupcake Tom has at first-----$3u+\frac{1}{2}u + 29$</p> <p>a) $3u + \frac{1}{2}u + 29 = 3\frac{1}{2}u + 29$ $3\frac{1}{2}u = 264 - 29$ $3\frac{1}{2}u = 235$ $235 \times \frac{2}{7} = 67.857$ $67.857 \times 2 = 135.714$ $135.714 + 29 = 164.714$ cupcakes</p> <p>b) $2u+58+3u+29+\frac{1}{2}u = 1539$ $5\frac{1}{2}u + 87 = 1539$ $5\frac{1}{2}u = 1539 - 87$ $= 1452$ $1u = 1452 \div 5\frac{1}{2}$ $= 264$ cupcakes</p>
Q13)	$40 \times 30 = 1200$ $80 \times 60 = 4800$ $4800 - 1200 = 3600$ $100.8 \text{ l} = 100800$ $3600 \times A = 100800$ $A = 100800 \div 3600 = 28\text{cm}$
Q14)	<p>a) $\angle DFC = 180^\circ - 60^\circ - 18^\circ = 102^\circ$ $90^\circ + 60^\circ = 150^\circ$ $180^\circ - 150^\circ = 30^\circ$ $\angle BAC = 30^\circ \div 2 = 15^\circ$</p> <p>b) $\angle BCF = 60^\circ - 18^\circ = 42^\circ$ $\angle AFC = 180^\circ - 42^\circ = 138^\circ$</p>
Q15)	<p>a) $120.80 - 5.20 = 115.60$ $115.60 \div 2 = 57.80$ $57.80 + 5.20 = 63$</p>

	$63 \div 3 = 21$ $21 \times 4 = \$84$ b) $31.20 - 21 = 10.20$ $10.20 + 57.80 = 68$ $\frac{10.20}{68} \times 100\% = 15\%$
Q16)	a) $15 \times 2 = 30$ $1006 - 30 = 976$ $8 \times 2 = 16$ $15 \times 3 = 45$ 6 pens for \$16 6 books for \$45 $45 + 16 = 61$ $976 \div 61 = 16$ 16 x 6 = 96 pens b) $96 + 4 = 100$ 2 books --- 15 100 books --- $50 \times 15 = \\$750$
Q17)	a) $2 + 6 + 10 + 6 = 24$ $24 \times 4 = 96m$ b) $\frac{1}{4} \times 3.14 \times 8 \times 8 = 50.24$ $\frac{1}{4} \times 3.14 \times 6 \times 6 = 28.26$ $50.24 - 28.26 = 21.98$ $21.98 \times 4 = 87.92$ $24 \times 24 = 576$ $576 - 87.92 = 488.08m^2$