



SINGAPORE CHINESE GIRLS' SCHOOL (PRIMARY)  
PRELIMINARY EXAMINATIONS 2010

NAME: \_\_\_\_\_ (      )

DATE: \_\_\_\_\_

CLASS: PRIMARY

Parent's Signature: \_\_\_\_\_

SCIENCE  
BOOKLET A

30 questions

60 marks

Total time for Booklets A & B: 1 h 45 min

DO NOT OPEN THIS BOOKLET UNTIL YOU ARE TOLD TO DO SO.

FOLLOW ALL INSTRUCTIONS CAREFULLY.



**Part I ( 60 marks)**

For each question from 1 to 30, four options are given. One of them is the correct answer. Make your choice (1, 2, 3 or 4). **Shade the correct oval (1, 2, 3 or 4) on the Optical Answer Sheet.**

1. Kennis observed 2 animals and presented her observations in the table below.

Observations	Animal A	Animal B
Live in water	No	Yes
Eats plants	Yes	Not seen
Lays eggs	Yes	No

Which of the following would be correct?

Animal A	Animal B
<del>M</del> Butterfly	Guppy
<del>2</del> Sparrow	Hamster
<del>3</del> Cockroach	Frog
<del>4</del> Angelfish	Platypus

2. Below are some statements about the human body systems. Which of the following is **incorrect**?

Systems	Statements
1) Circulatory	Consists of blood vessels, blood and the heart.
2) Digestive	Digestive juices are present in the large intestine.
3) Respiratory	The windpipe connects the nose and mouth to the lungs.
4) Skeletal	Works together with muscular system to enable movement.

3. Study the flowchart below.

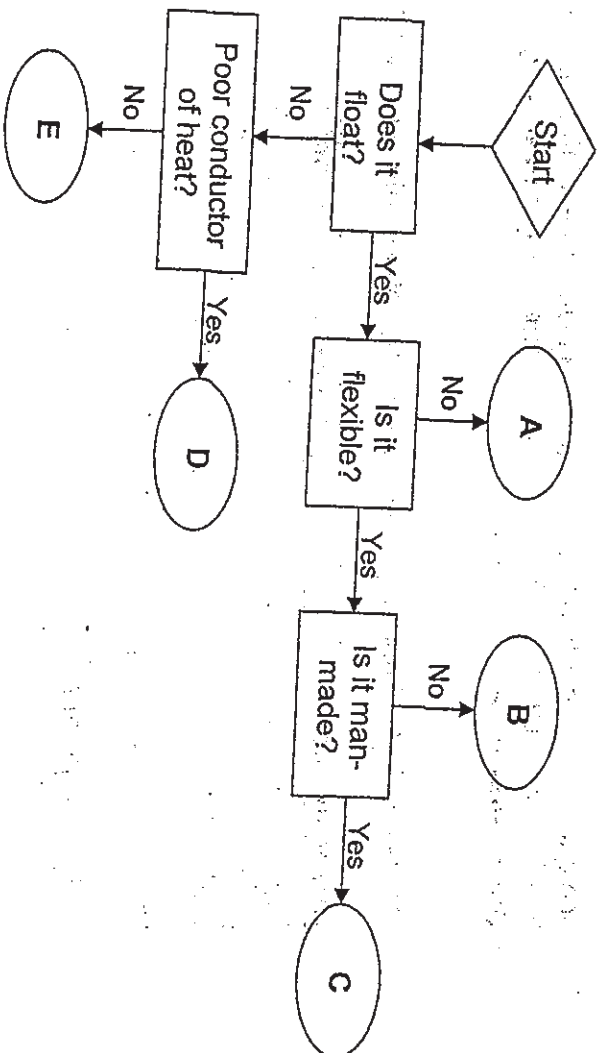

Which of the following is suitable for making part X of the iron?

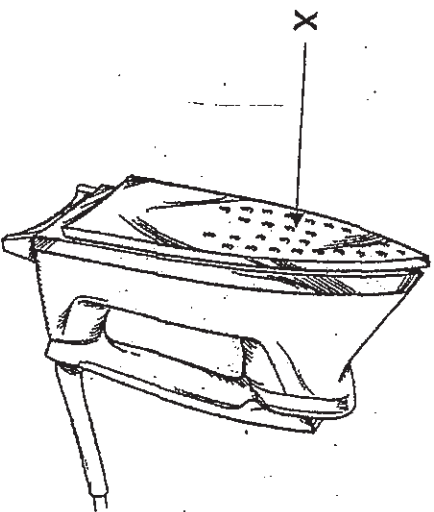

~~A~~  
~~C~~

~~D~~  
~~E~~

4. Peter wants to find out how fast a toy boat can sail when its sail is made of different materials. The size of the sails is kept the same. He then set up the following experiment.

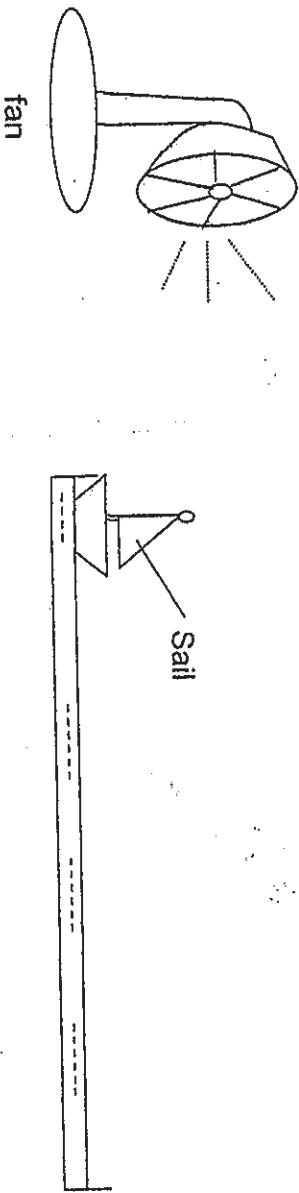

He turned on the fan and the wind generated moved the boat across the trough filled with water. He recorded the time taken by the boat to travel across the trough. The result of the experiment is shown in the table below.

Material of sail	Time taken by boat (mins)
R	5
T	7
S	3
U	8

Which material is more efficient at 'catching' wind during the sailing of a boat?

- 1) R      3) S  
2) T      4) U

5. Samuel wants to measure 78ml of limewater in order to carry out an experiment. Which of the following apparatus should he use?

1)

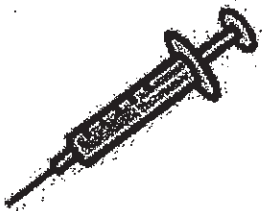

3)

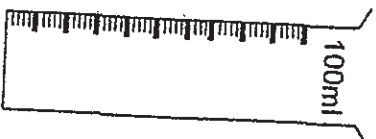

2)

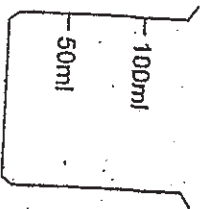

4)



6. Alan observed a cell under a microscope and made the following observations.
- A) It has a nucleus.
  - B) It has a cell wall.
  - C) It has cytoplasm
  - D) It has chloroplasts.

Which of the following could the cell be from?

~~A)~~ Roots  
~~B)~~ Bacteria

~~C)~~ Stems  
~~D)~~ Flowers

7. Sammy placed a cup in the freezer for 2 hours. After 2 hours, he took it out and poured some water at room temperature, which was 28°C, into it. She then measured the temperature of the water after 5 minutes and found that its temperature had dropped to 20°C. Sammy then wrote the following explanations based on the outcome of the experiment.

- A: The cup gained heat from the water.
- B: Water gained coldness from the cup.
- C: The heat from the water was lost to the surrounding air.
- D: The coldness from the water was transferred to the surrounding air.

Which of the following correctly explains the outcome of the experiment?

- 1) A only
- 2) A and C only

- ~~3) B and D only~~
- ~~4) C and D only~~

8. Which of the following arrangement(s) will enable both bulbs to light up?

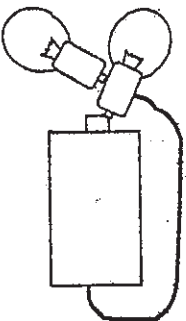

A



B

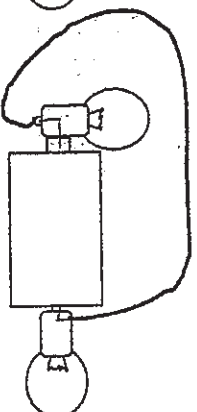

C

- ~~1) A only~~
- ~~2) A and C only~~

- ~~3) B only~~
- ~~4) B and C only~~

9. Erin was given a circuit card and a circuit tester as shown below. When one end of the circuit tester was clipped onto B and the other end to D, the bulb lighted up.

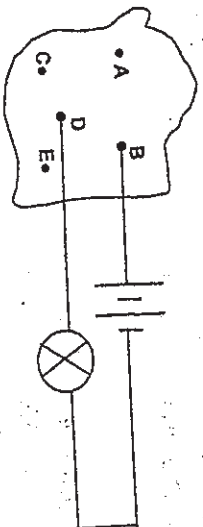

The following diagrams show the reverse side of the above circuit card. Which one correctly shows how the wires were connected?

1)

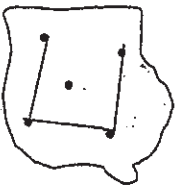

3)

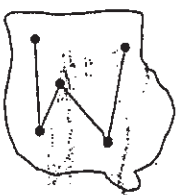

2)

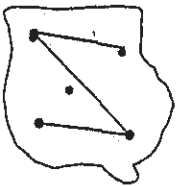

4)





10. Kirsten placed the same box on 3 different surfaces and using a spring balance, measured the force needed to move the box. The results are shown in the table below.

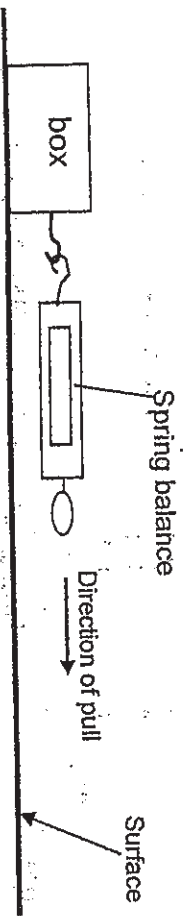

Types of surfaces	Force needed (g)
L	85
M	200
N	125

Given the above data, which of the following best represents L, M and N?

L	M	N
Polished wood	Oiled glass	Sandpaper
Oiled glass	Sandpaper	Polished wood
Sandpaper	Oiled glass	Polished wood
Polished wood	Sandpaper	Oiled glass

- ~~1) 3)~~  
 2) ~~3)~~  
 4)

11. Henry used a 10-cm elastic band to make a weighing machine as shown in the diagram below.

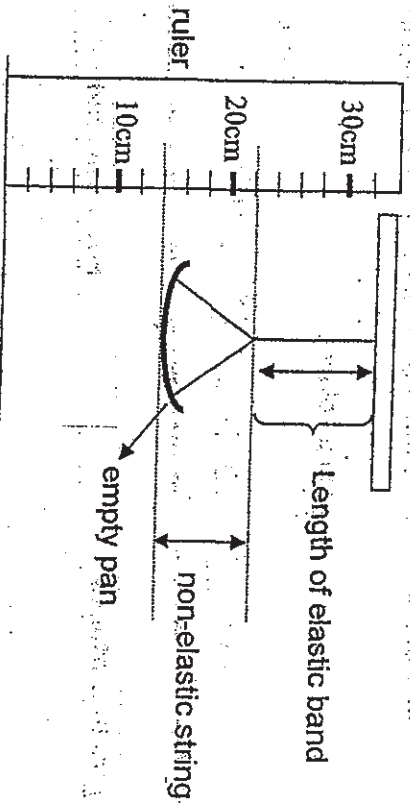

He added different weights to the pan, found out the extension of the spring <sup>elastic band</sup> each time and plotted a graph.

Which graph shows his results when the load in the pan was increased?

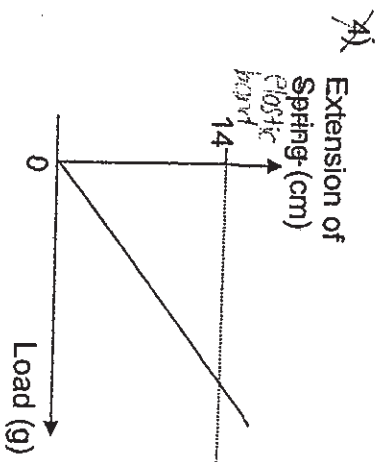
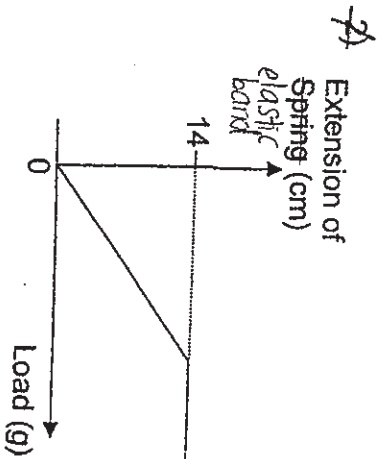
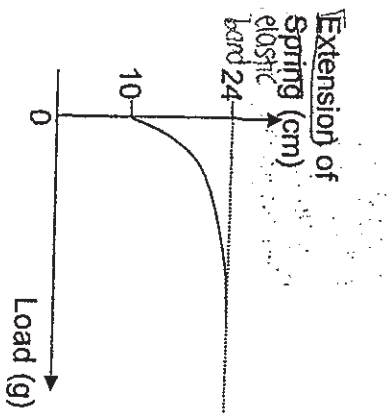
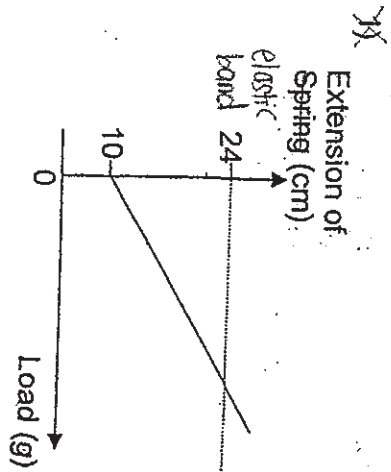

12. Andrew carried out the experiment below. He rolled the iron ball down the wooden plank and recorded the time taken for the ball to travel from A to M and M to V before and after object X was placed below the ramp as shown above. The results were then tabulated as shown below.

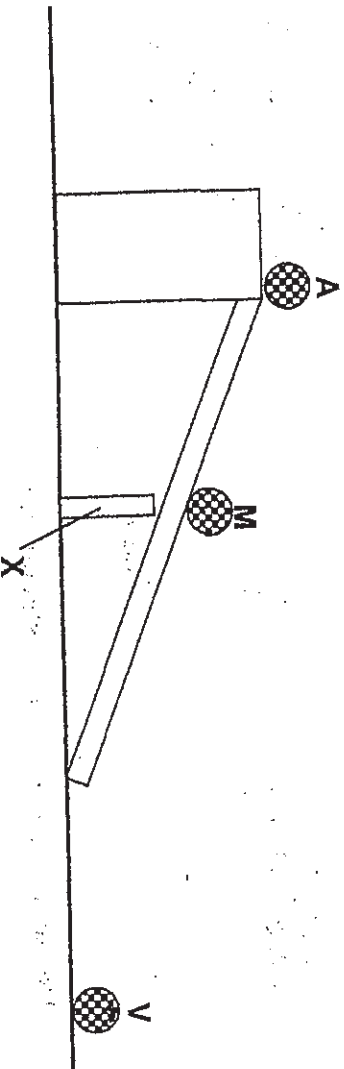

	Time taken to travel from A to M (seconds)	Time taken to travel from M to V (seconds)
Without object X	6.4	8.2
With object X	5.8	12.7

Which of the following could be a possible explanation for the difference in the time taken for the ball to travel from M to V?

- More gravity was acting on the ball resulting in slower travelling time.
- Object X was a magnet and was attracting the ball, resulting in slower travelling time.
- Object X was a magnet and was repelling the ball, resulting in faster travelling time.
- The surface of the ramp became rougher with more revolutions resulting in slower travelling time.

13. Lena inflated 4 similar balloons using an air pump. After she had pumped the balloons, she wanted to assess the explosive force of each balloon by measuring how loud the bursting was. Distance between the sensor and balloon was kept the same for all the balloons.

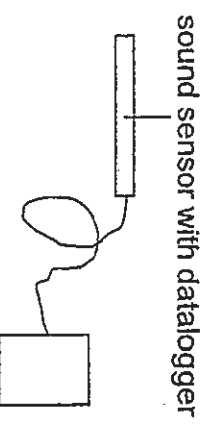
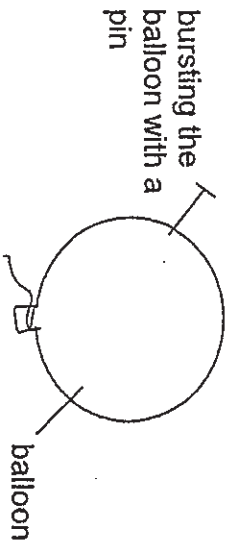

Below is a table of the data she recorded.

Balloon	Number of Pumps	Volume of air in balloon (cm <sup>3</sup> )	Volume of Sound Recorded (decibels)
A	10	300	40
B	15	450	53
C	20	600	70
D	25	750	78

What assumptions did Lena make before her experiment?

- A: The compression of air in the balloon affects the force it bursts with.
- B: The timing of the experiment will affect the loudness of the balloon bursting.
- C: The loudness of balloon bursting is related to the explosive force of the bursting balloon.
- D: Distance between the balloon and sound sensor will affect the accuracy of the sound measurement.

C only  
 A, B and D only

A, C and D only  
 A, B, C and D

14. A bar magnet is broken into 3 parts as shown below.

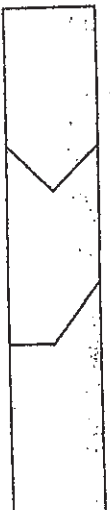

Which of the following is **not** possible when 2 pieces of the magnet are brought together?

1)

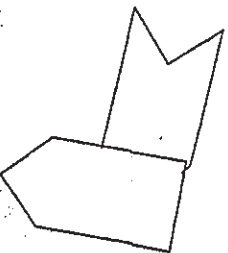

3)

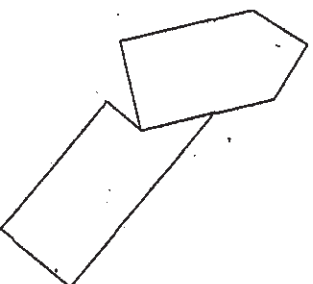

2)

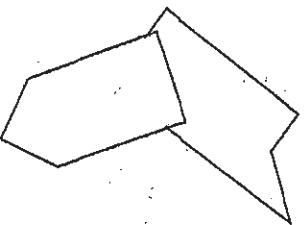

4)

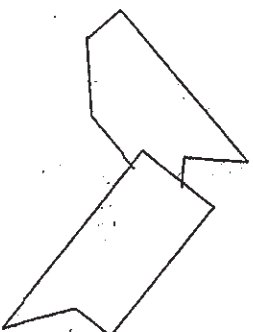

15. Suzy turned a nail into an electromagnet using the set-up below. She then brought paper clips to test the strength of the magnetic force. She did this each time there is a change in the number of batteries and coils. The table below shows the result.

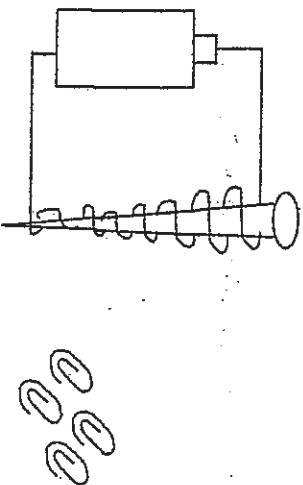

No. of coils	No. of batteries	No. of paper clips attracted
20	4	13
40	4	26
20	6	?
20	8	34
40	6	48

Which of the following is the most likely number of paper clips attracted by the electromagnet when there are 20 coils around it and 6 batteries were used?

~~11~~ 11  
~~15~~ 15

~~23~~ 23  
~~40~~ 40

16. Larry found that when he changed the way the batteries were arranged as shown in the diagrams below, the poles of the electromagnet would be changed.

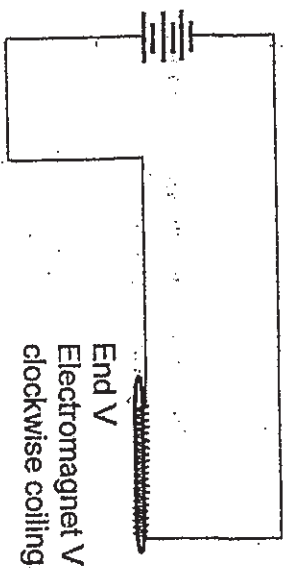
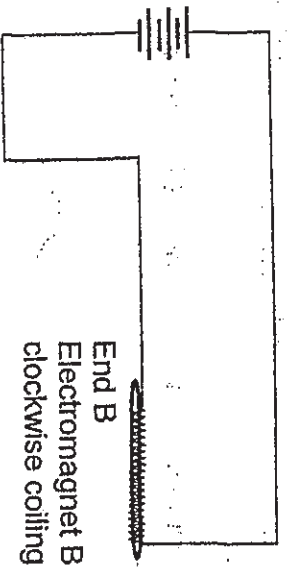

Larry found that when he changed the direction of the coiling around the nail the poles of the electromagnet would be changed also.

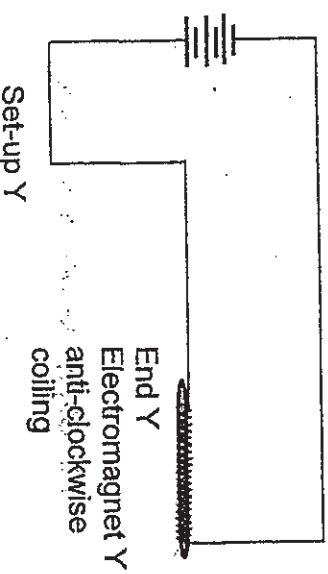
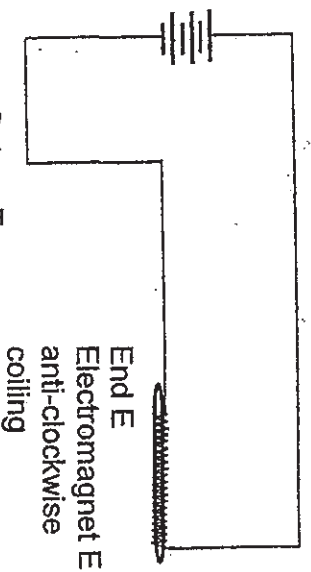

Larry tested one end of each electromagnet against a bar magnet's South-seeking pole.

Which of the following observations is possible?

Set-up B's End B	Set-up E's End E	Set-up V's End V	Set-up Y's End Y
Attracted	Attracted	Repelled	Repelled
Attracted	Repelled	Attracted	Repelled
Repelled	Repelled	Attracted	Attracted
Attracted	Repelled	Repelled	Attracted

~~X1~~  
~~X2~~  
~~X3~~  
~~X4~~

17. Study the table below carefully.

Producer	Herbivore	Carnivore	Omnivore
J	H and K	P and S	R and U

Which of the following food webs correctly shows the food relationship of the organisms above?

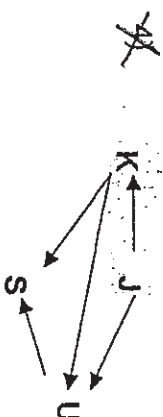
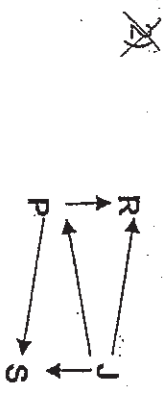
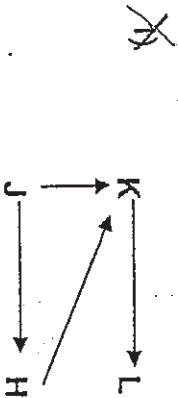

18. Study the food chain below.

$F \rightarrow G \rightarrow H \rightarrow L$

Which of the following statements about the food chain is true?

- 1) H is an omnivore while L is a carnivore.
- 2) Not all of G's energy is transferred to H.
- 3) The energy produced by F is destroyed along the way.
- 4) L gets most of the energy as it is at the end of the food chain.

19. Which of the following activities lead to global warming?

- A: Deforestation  
 B: Soil erosion  
 C: Burning of fossil fuels  
 D: Dumping chemicals into oceans

- 1) A and B only
- 2) A and C only
- 3) B and C only
- 4) C and D only



20. Study the energy conversion below.



The energy conversion shown above is most likely to be found in a \_\_\_\_\_.

~~dynamic~~  
~~electric kettle~~

~~ceiling fan~~  
~~mobile phone~~

21. A group of girls conducted the experiment below. They filled similar beakers with various types of liquid of equal amount and shone a torch at them as shown below. The two items were placed in a black box. A light detecting datalogger was also placed in the black box. They recorded the results in the table below.

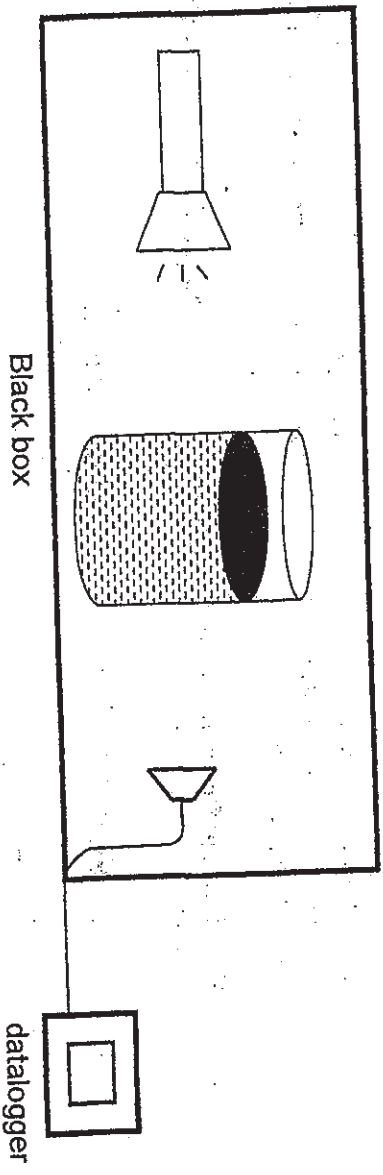

Beaker	Amount of light detected (Lux)
A	3205
B	5850
C	500
D	2365

Based on the results, which of the following best represent the 4 liquids?

A	B	C	D
Mineral water	Orange Juice	Tea	Milo
Tea	Mineral water	Milo	Orange juice
Milo	Tea	Orange juice	Mineral water
Orange Juice	Milo	Mineral water	Tea

22. Study the set-up below.

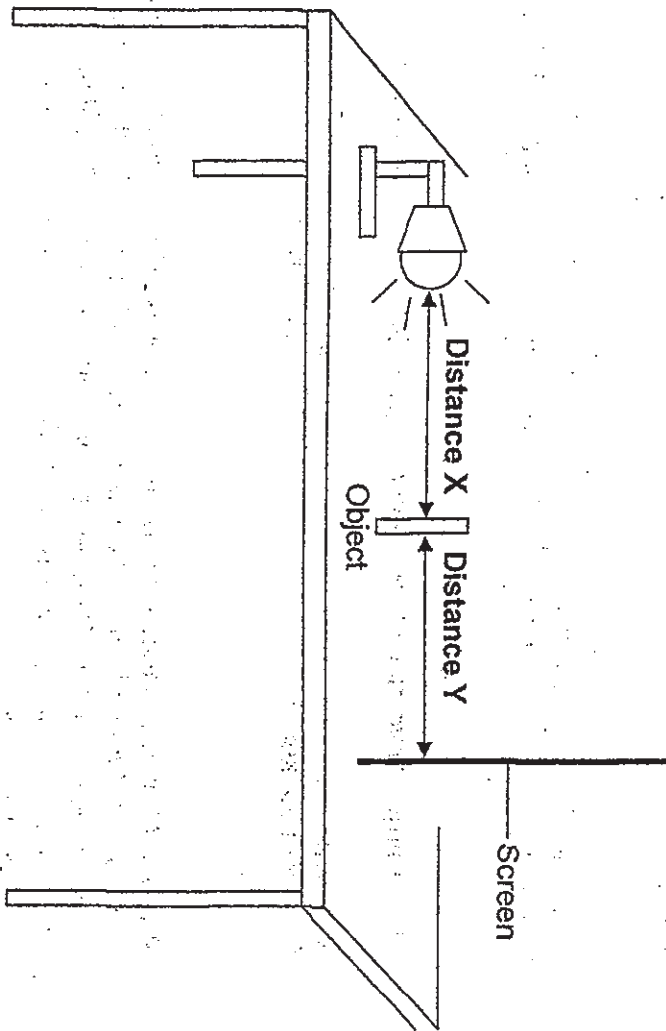

The lamp was switched on and a shadow was formed on the screen. Keeping the object stationary, the height of the shadow can be varied by moving the lamp and the screen.

Which of the following distances will result in the longest shadow formed on the screen?

Distance X (cm)	Distance Y (cm)
20	7
14	13
10	17
17	10

~~A~~  
~~B~~  
~~C~~  
~~D~~

23. 5 friends had a short discussion on heredity after their lesson. Below was what was discussed.

Anne: I believe that the length of a person's hair can be inherited.  
 Ben: No. The colour of the irs can be passed down from parents to young.

Candice: Yes. I agree with Ben. Just like having high cheekbones, it is inherited.

Dennis: I disagree with Ben. The length of toenails, similar to hair length, is passed down from parents to young.

Emma: I think the length of eyelashes is an inherited characteristic.

Which of the children are correct about heredity?

- Anne, Ben and Dennis only
- Ben, Candice and Emma only
- Anne, Candice and Emma only
- Ben, Candice and Dennis only

24. Study the table below.

	Dispersed by splitting?	Fleshy parts?	Dispersed by animal?
Fruit S	✓		
Fruit T		✓	✓

Which of the following pairs can Fruits S and T be?

S	T
Lady's finger	Rubber
Angsana	Love grass
Nipah	Mango
Flame of the forest	Durian

~~X~~  
~~X~~  
~~X~~  
~~X~~

25. Evelyn put up the 2 set-ups below. Both set-ups had a datalogger attached to them detecting the amount of carbon dioxide in the airtight container. They were placed in an area where natural light was available. She carried out the experiment for 24 hours. Then, she plotted a graph using the collected data.

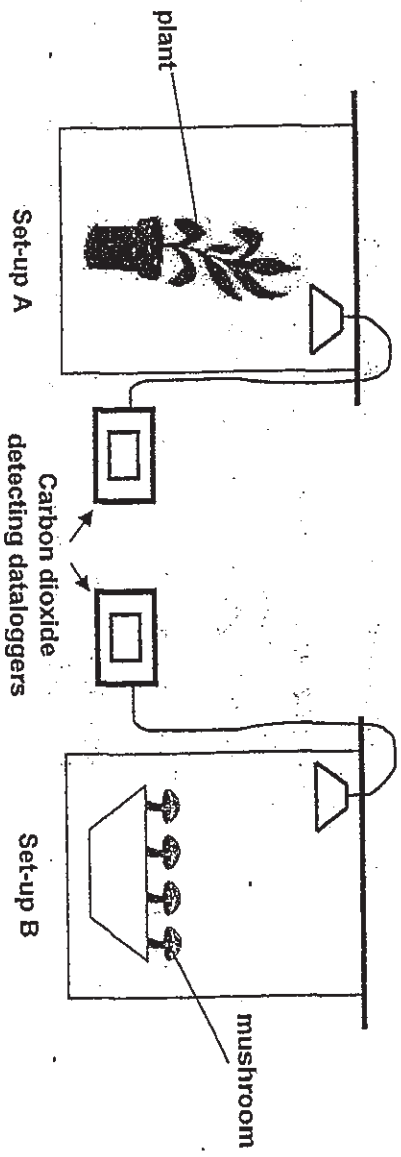

Which of the following graphs could Evelyn have plotted?

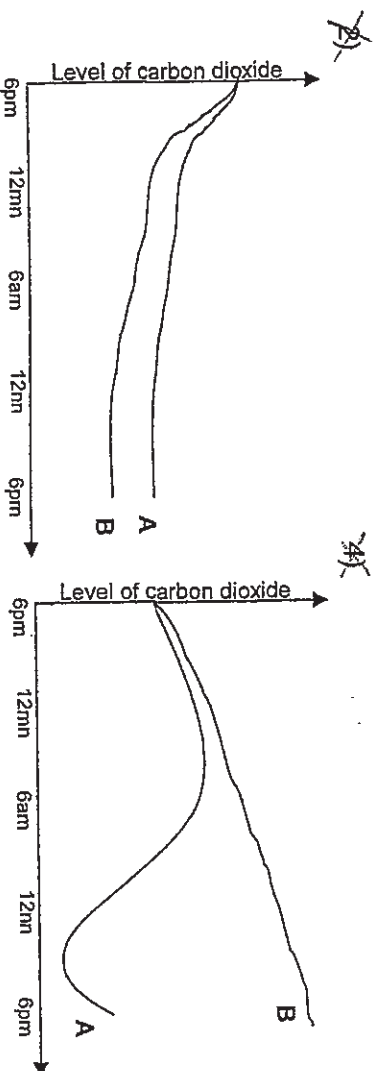
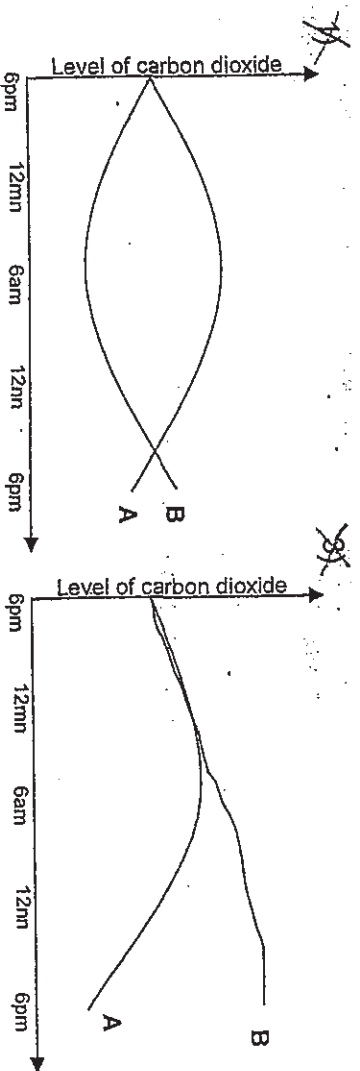

26. Alice conducted an experiment as shown below. She covered her cup of hot chocolate with a cup cover. She took the temperature of the hot chocolate before and after the experiment. She repeated the experiment with 3 other cup covers, each made with a different material.

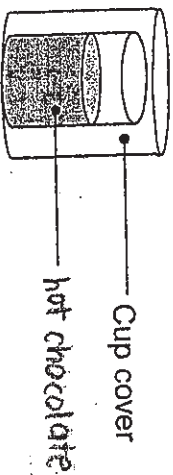

Alice knew that in order to have a fair test, she had to identify which variables had to be kept constant.

- A: Material of cover
- B: Size of cup
- C: Initial temperature of hot chocolate
- D: Temperature of surrounding
- E: Duration of experiment

Which of the following correctly identifies the variables that must be kept constant?

- ~~A, C and E only~~
- ~~B, C and D only~~
- ~~B, C, D and E only~~
- ~~A, B, C, D and E~~

27. Pauline just learnt about reproduction in plants. She has drawn 4 cycles to show the sequence of the processes involved but is unsure which is correct. Which cycle is the correct sequence of the processes involved in the reproduction in flowering plants?

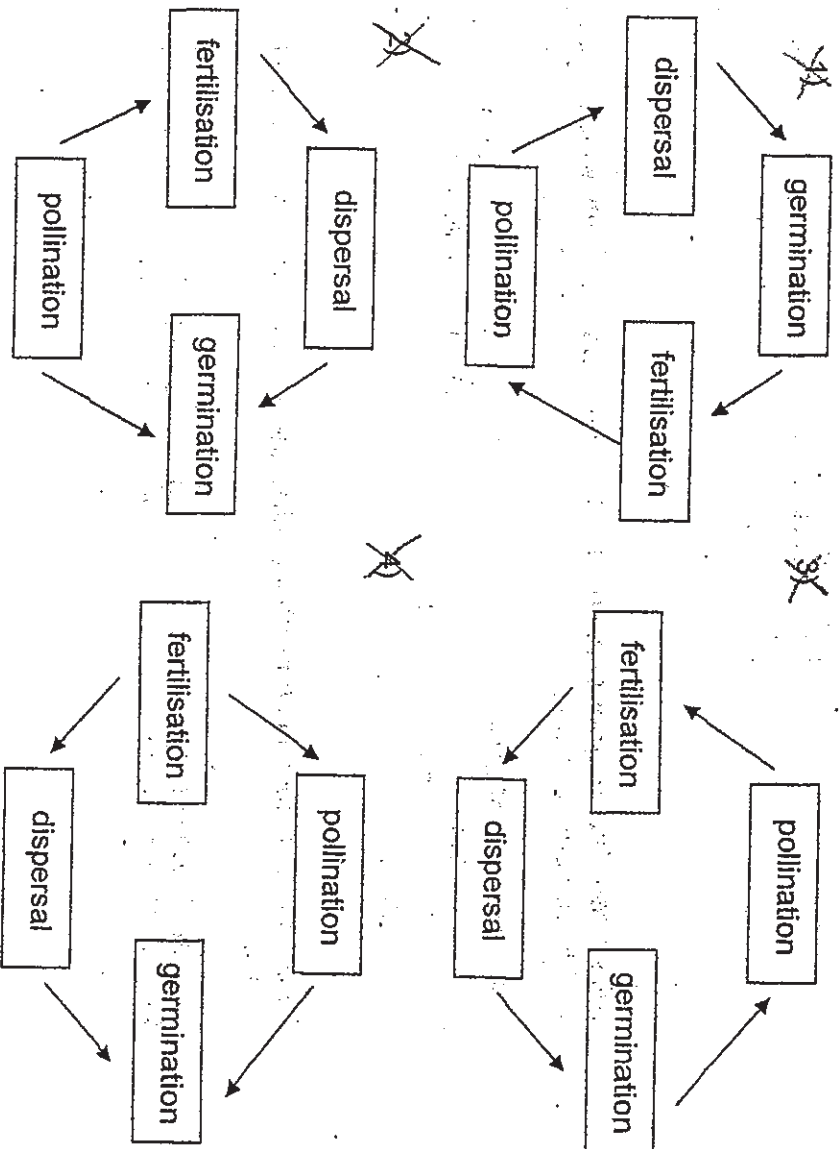

28. June set up the following experiment in the Science laboratory. She wanted to find out if the temperature inside the box is affected by the colour of its inner walls.

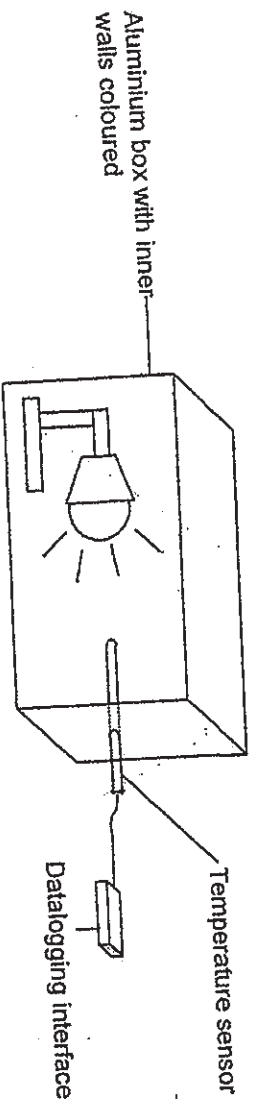

The lamp was lit for 15 minutes and the temperature inside the box was recorded. He repeated the experiment using boxes of the same size with different coloured inner walls. She plotted graphs using the data she collected.

Which of the following graphs best represent the results of June's experiment?

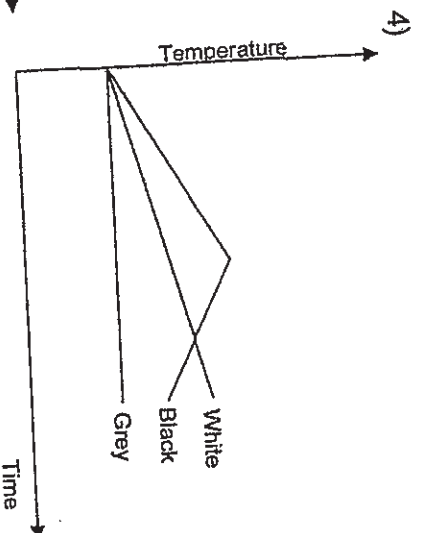
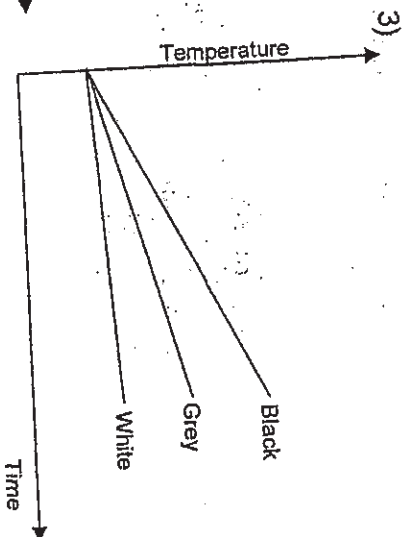
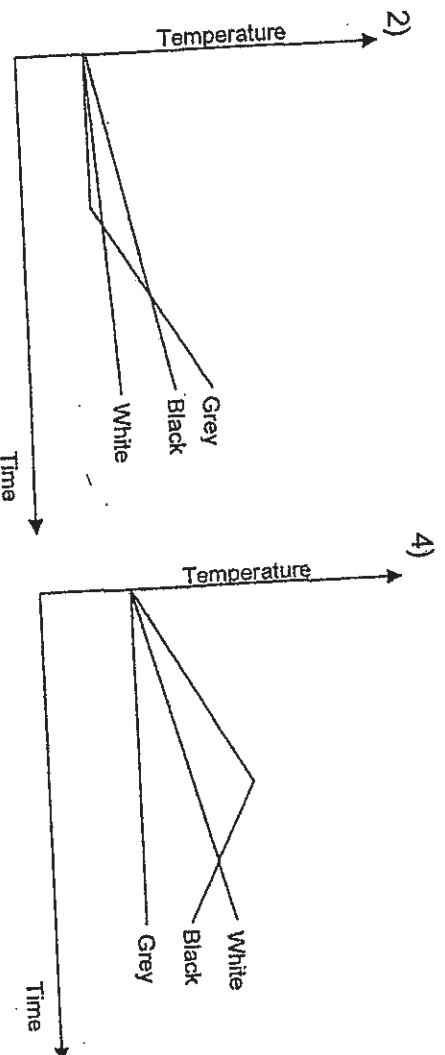
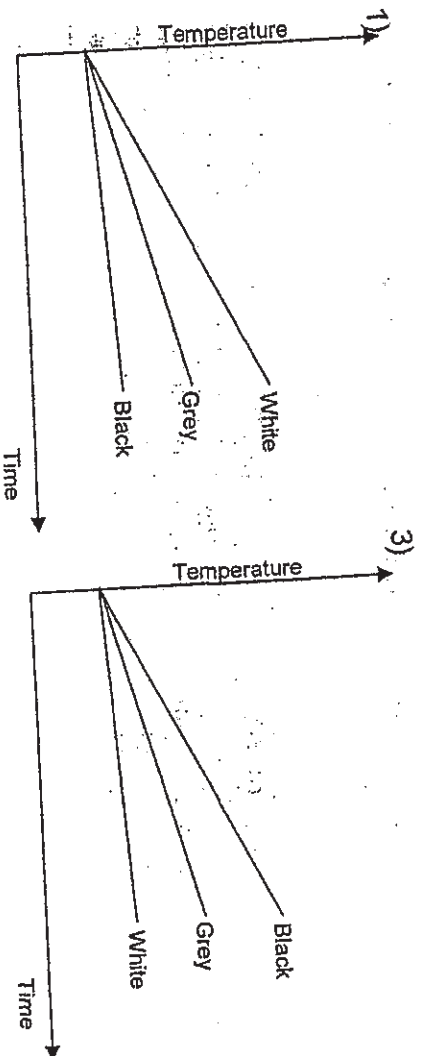

29. Peter was given Substance S. The following graph depicts the changes Substance S goes through.

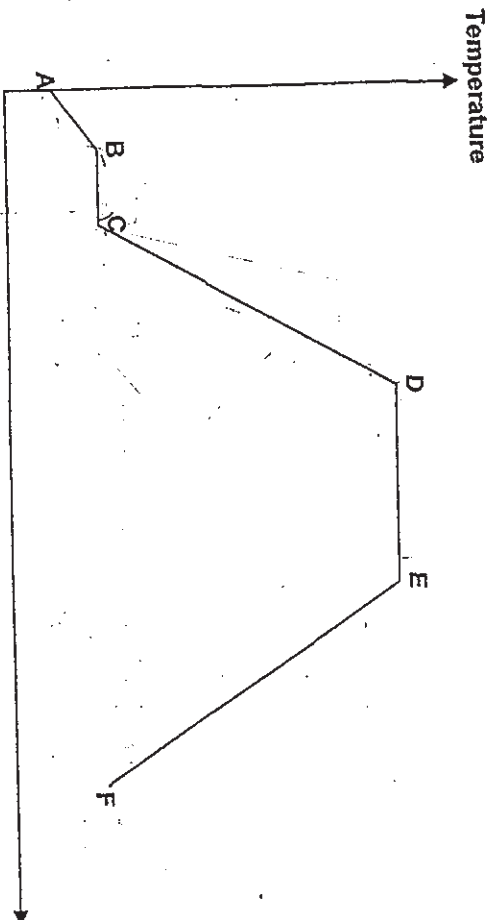

Referring to the above graph, which of the following correctly matches the states of Substance S?

Period AB	Period BC	Period DE
<del>Solid</del>	Solid and Liquid	Gaseous and Liquid
<del>Solid and Liquid</del>	Solid and Liquid	Gaseous
<del>Solid and Liquid</del>	Solid	Gaseous
<del>Solid</del>	Liquid	Gaseous



30. Look at the diagrams below.

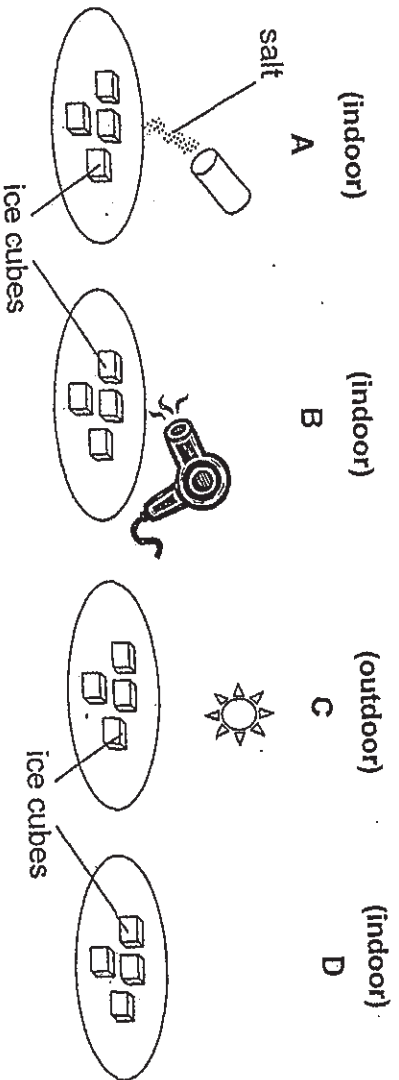

Which of the following pairs of set-ups are correctly chosen to investigate the corresponding aim?

Set-ups	Aim
A and B	Find out if salt will speed up melting of ice
A and C	Find out if salt will slow down melting of ice
B and C	Find out if sunlight will speed up melting of ice
B and D	Find out if increased in temperature will speed up melting of ice

~~A and B~~  
~~A and C~~  
~~B and C~~  
~~B and D~~

End of Booklet A

...the ... of ...  
...the ... of ...  
...the ... of ...

...the ... of ...  
...the ... of ...  
...the ... of ...

...the ... of ...  
...the ... of ...  
...the ... of ...

...the ... of ...  
...the ... of ...  
...the ... of ...



SINGAPORE CHINESE GIRLS' SCHOOL (PRIMARY)  
PRELIMINARY EXAMINATIONS 2010

NAME: \_\_\_\_\_ (    )      DATE: \_\_\_\_\_

CLASS: PRIMARY 6

Parent's Signature:  
\_\_\_\_\_

SCIENCE  
BOOKLET B

	Total Actual Marks	Total Possible Marks
Booklet A		60
Booklet B		40
Total		100

14 questions  
40 marks

Total time for Booklets A & B: 1 h 45 min  
**DO NOT OPEN THIS BOOKLET UNTIL YOU ARE TOLD TO DO SO.**  
**FOLLOW ALL INSTRUCTIONS CAREFULLY.**

32. Ben wanted to test if the number of leaves affects the rate of water travelling up the stem of plants. He was given the following items:

- 3 similar balsam plants
- 3 similar beakers
- 900ml of water containing red dye
- scissors

In the table below, Ben wrote out the steps he should take to carry out a fair test. He had used all the items.

Steps	Instructions
1	Pour 300ml of water into the each beaker.
2	<u>Cut all the leaves from 1<sup>st</sup> and 2<sup>nd</sup> plant.</u> Leave all the leaves on 3 <sup>rd</sup> plant
3	Put each plant into each beaker and place the beakers on a table in a room.
4	Conduct the experiment for 7 days.

However, there is a mistake in one of the steps above. Underline the mistake and write the correct step that he should take below. [2]

---

---

---

---

Score	
-------	--

33. Below is an incomplete flowchart showing the flow of blood in the human body.

Other parts of body

heart

lungs

- a) (i) Draw arrows to show the correct flow of blood in the body  
 (ii) Label the arrows with either '\*Oxygenated blood\*' or '\*Deoxygenated blood\*' [2]

\*Oxygenated blood is blood rich in oxygen while deoxygenated blood is blood rich in carbon dioxide.

- b) Jordan has just relieved himself and he is now feeling hungry. He buys himself a plate of spaghetti and has it for lunch. The graph below shows the changes in the amount of undigested food that passes from his mouth to the small intestine.

Complete the graph below by drawing in the amount of undigested food that is found in Jordan's stomach, small intestine and large intestine. [1]

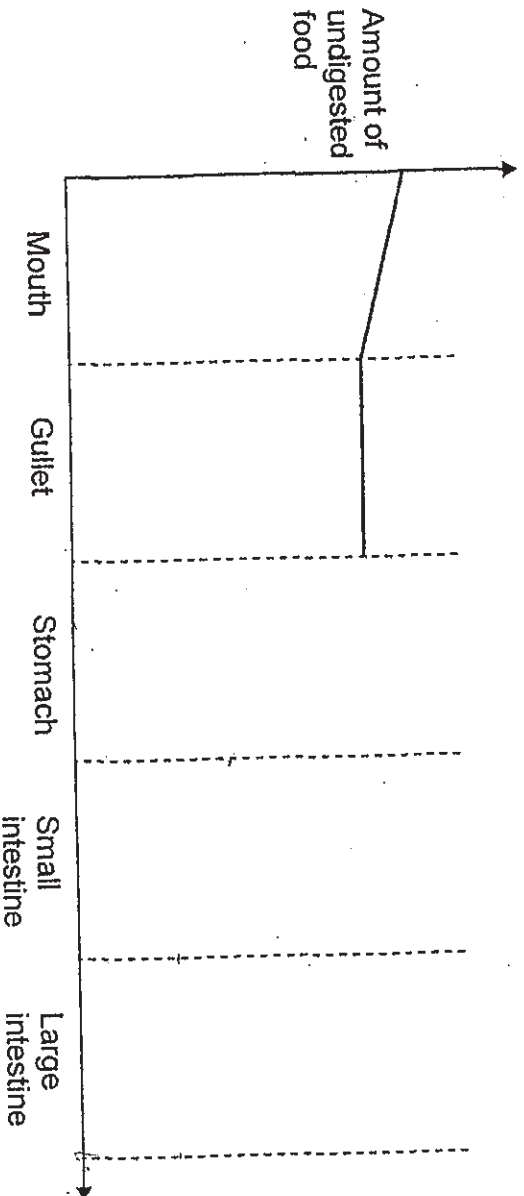

Score	
-------	--

34. Study the classification chart below.

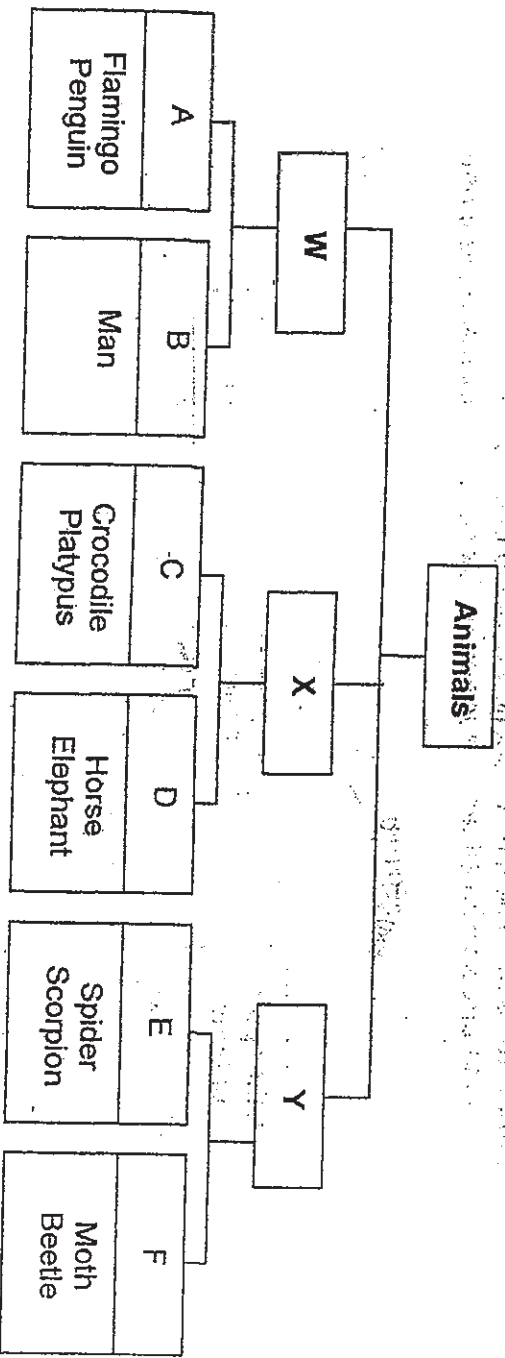

a) What sub-headings could W, X and Y be?

[3]

W :	
X :	
Y :	

b) State a difference in the life cycle of the animals in Groups C and F.

[1]

---



---

(Go on to the next page)

Score	
-------	--

35. Polar bears are found in cold places. They have adaptations in the form of structural and behavioural characteristics that allow them to survive in such an environment.



Identify 2 structural adaptations and explain clearly why the polar bear will not survive in a desert. [2]

i)

---

---

ii)

---

---

B-5

(Go on to the next page)

Score	
-------	--

36. Study the food web shown below.

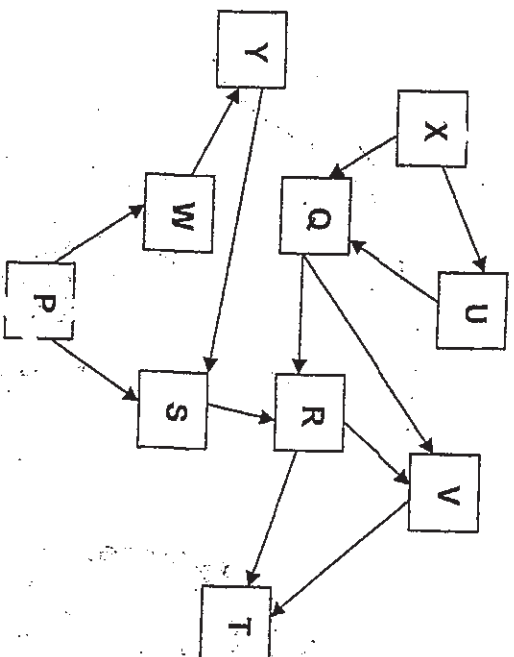

a) In the food web above, circle the food producer(s).

[1]

b) Write out the longest food chain found in the above food web.

[1]

c) What is the effect on P if there is a decrease in the population of Y?  
Give 2 reasons for your answer.

[2]

---

---

---

B-6

(Go on to the next page)

Score	
-------	--



37. Town P is located at the downstream of River Y. The local authorities decided to switch to a more environment-friendly source of electrical energy. They built a hydroelectric power station and a dam across River Y at the upstream. Ever since then, Town P has been getting its supply of electricity from this power station.

Below are graphs that depict the amount of rainfall experienced by Town P and the river, and the amount of electricity generated at the power station for a year.

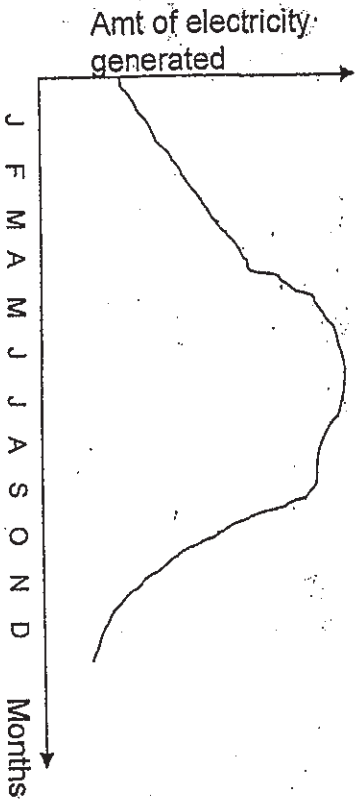
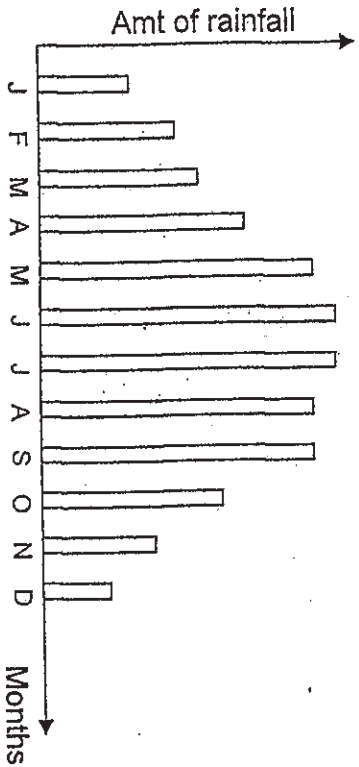

- a) State the relationship between the amount of rainfall and the amount of energy generated. [1]

---



---

- b) Town P was hit by a drought for 3 months. Explain how the amount of rainfall affect the amount of electricity generated. [2]

---



---

38. A group of boys made 3 identical parachutes such as the one shown below. They hung a box weighing 20g on one parachute, a box weighing 30g on the second parachute and a box weighing 40g on the third parachute. They released the three parachutes at the same time from the second storey of their school. They repeated their experiment and recorded the results in the table below.

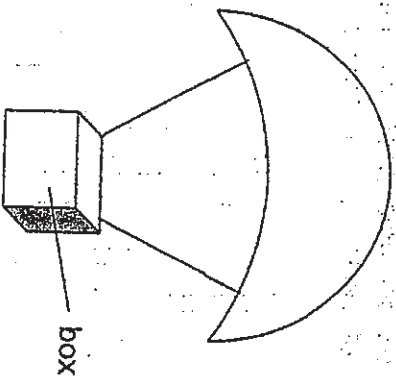

	Time taken to land		
Parachute with 20g weight/box	78s	79s	80s
Parachute with 30g weight/box	64s	62s	63s
Parachute with 40g weight/box	49s	50s	50s

- a) Why were 20g, 30g and 40g weights more suitable than using 1g, 2g and 3g weights in this experiment? [1]
- \_\_\_\_\_
- \_\_\_\_\_
- b) Write the energy conversion from the time the parachute is released to the time it lands on the ground. [1]
- \_\_\_\_\_
- \_\_\_\_\_
- c) What can be concluded from the results of the experiment? [1]
- \_\_\_\_\_
- \_\_\_\_\_

39. Study the Lee family tree below.

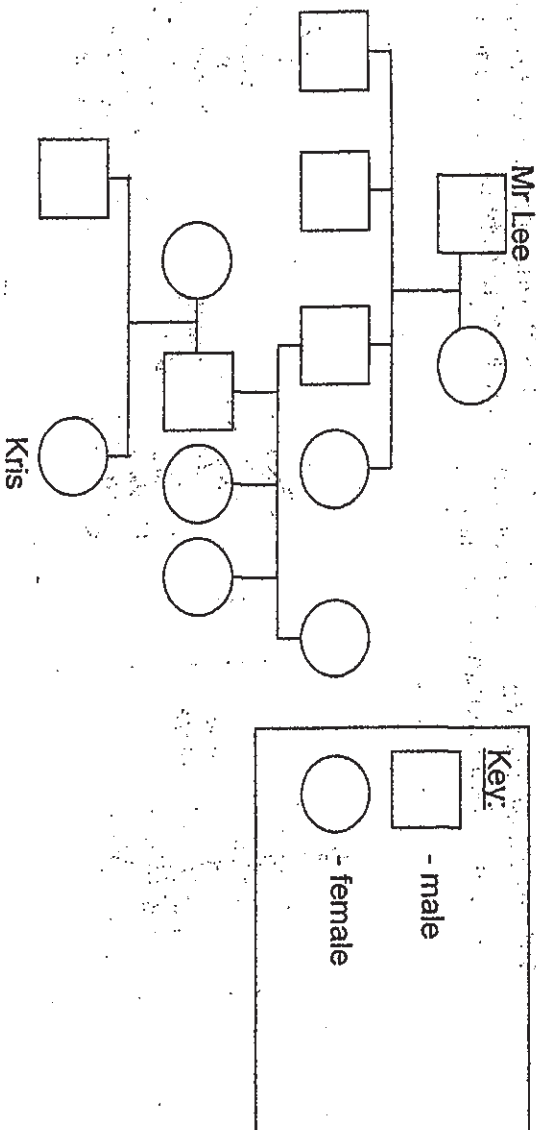

- a) How many grandchildren does Mr Lee have? [1/2]
- 
- b) Tim has 2 sisters. Indicate Tim with an 'X' on the family tree. [1/2]
- c) The males in the Lee family are affected by a rare disease. Though the disease does not affect the females, they are the carriers. [1/2]

A person who is a carrier of a disease/trait has the genes carrying the disease/trait in him/her but the disease/trait is not shown in his/her appearance.

Explain how it is possible for Kris to be a carrier of this rare disease. [1]

---

---

40. Samantha put up the 3 set-ups below. All the set-ups had similar plants and 250ml of water each but different humidity levels. She conducted the experiment for 3 days. She wanted to find out if humidity level affects the amount of water lost by the plant through its stomata.

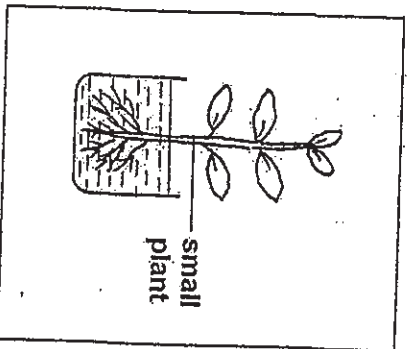

Set-up A  
\*Humidity : 90%

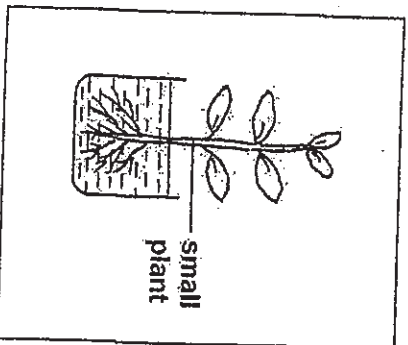

Set-up B  
Humidity : 29%

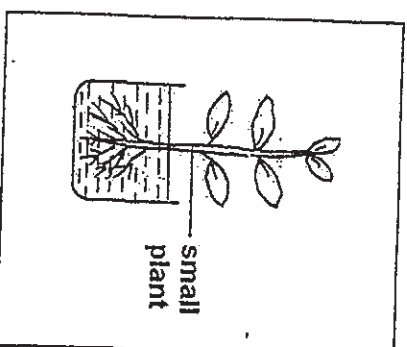

Set-up C  
Humidity : 57%

\*Humidity is the amount of water vapour in the surrounding.

At the end of 3 days, she presented her findings in the table below.

	Set-up A	Set-up B	Set-up C
Amt of water in the beaker at the end of 3 days	235ml	202ml	221ml
Mass of plant at the beginning of experiment	350g	350g	350g
Mass of plant at the end of experiment	325g	343g	335g

- a) What can be concluded about the relationship between the humidity level and the amount of water lost by plants through its stomata? [2]

- b) Why will having a layer of oil to cover the water make it a fairer test? [2]

B-10

(Go on to the next page)

Score

41. Suzanne set up the following electric circuit.

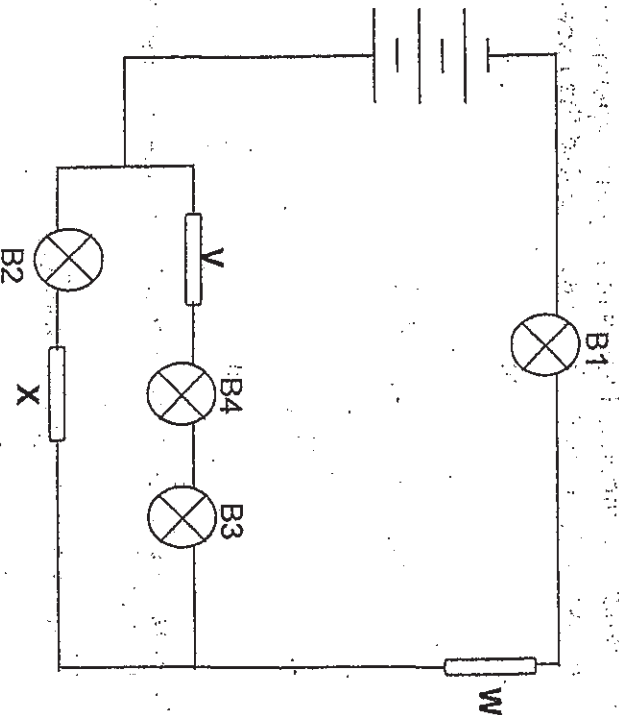

V, W and X are different materials. Identify the bulbs that will light up in the different situations below. [3]

V	W	X	Bulbs that light up
Magnet	Plastic ruler	Aluminium foil	
Aluminium foil	Staples	Eraser	
Leather strip	10-cent coin	Iron nail	

B-11

(Go on to the next page)

Score	
-------	--

42. A group of students conducted an experiment with a shorea fruit which had 3 "wings". They dropped the fruit from 3 metres above the ground and recorded the time it took to reach the ground. They repeated the experiment with the same fruit but removed 1 "wing" each time they repeated the experiment.

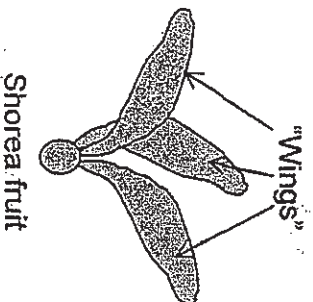

The table below shows the different experiments with the number of "wings" attached to the shorea fruit.

Experiment	Number of "wings" attached to the shorea fruit
A	3
B	2
C	1

- a) Based on the table above, arrange the results of Experiment A, B and C from the fastest to the slowest. [1]

- b) Draw a bar graph below to show the relationship between the number of "wings" and time taken for the fruit to reach the ground. [1]

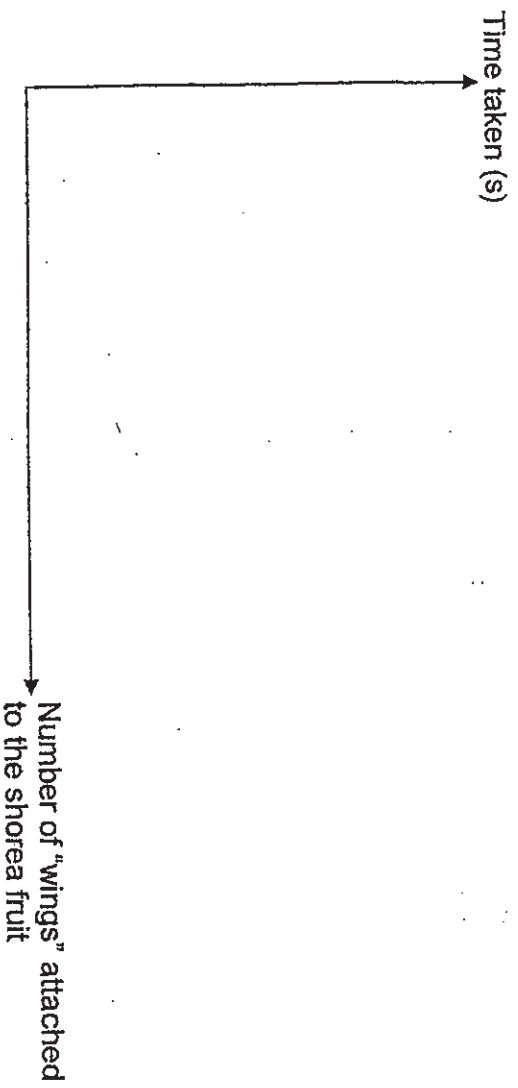

B-12

(Go on to the next page)

Score	
-------	--

43. Recently, an oil spill occurred at the Gulf of W. Some petrol had leaked out from a ship that was travelling along the gulf. The diagram below shows part of the coastline of the Gulf of W and where the oil spill had occurred.

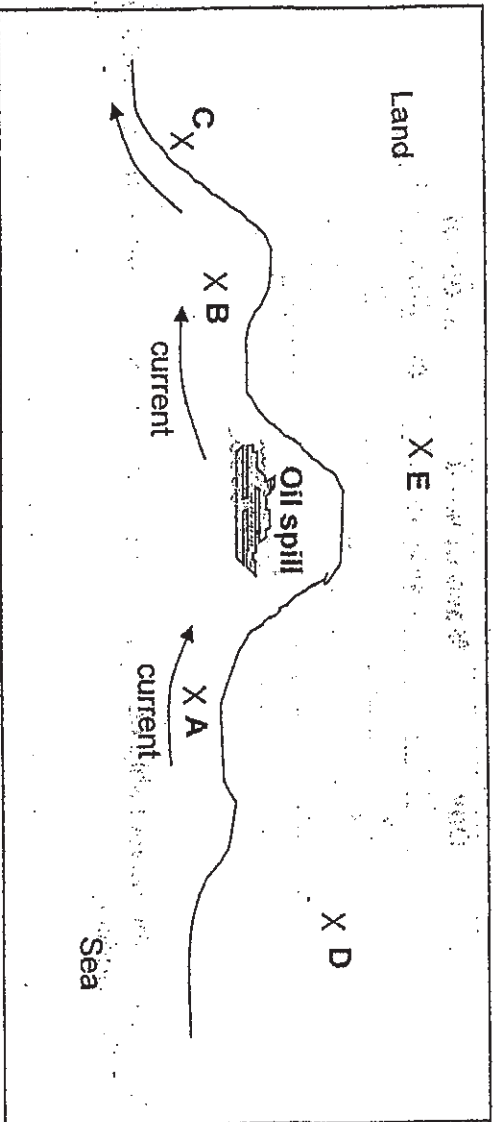

A, B, C, D and E are organisms that live around the area as shown above. The bar graph below shows the population of the organisms before and after the oil spill.

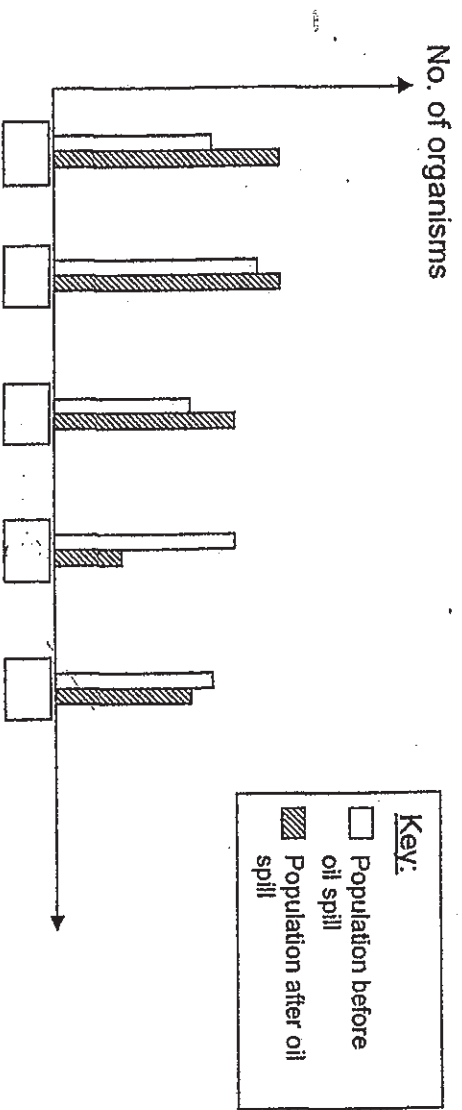

a) Indicate in the right box on the graph, the bar graph that best represent the population of Organism B. [11]

b) Explain the difference in the effects of the oil spill on the populations of Organisms A and B. [2]

44. Alyson planted some seeds and recorded the mass of the seed leaves and the average height of the plant. The table below shows the mass of the seed leaves of a seedling as it grows.

Day	Mass of seed leaves (g)	Height of seedling (cm)
1	5	0.5
3	3.5	2.5
5	2	4.5
7	0.5	6

- a) Explain the relationship between the mass of the seed leaves and the height of the seedling. [2]

---

---

---

End of Booklet B

Score	
-------	--



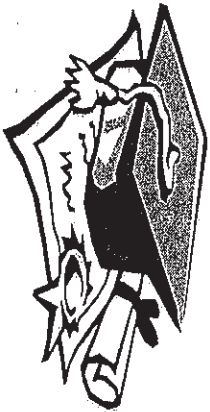

# ANSWER SHEET

**EXAM PAPER 2010**

**SCHOOL : SCGS PRIMARY**

**SUBJECT : PRIMARY 6 SCIENCE**

**TERM : PERLIMINARY**

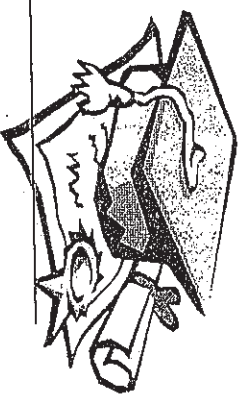

Q1	Q2	Q3	Q4	Q5	Q6	Q7	Q8	Q9	Q10	Q11	Q12	Q13	Q14	Q15	Q16	Q17
1	2	4	3	3	3	2	4	3	2	2	2	3	3	3	4	4
Q18	Q19	Q20	Q21	Q22	Q23	Q24	Q25	Q26	Q27	Q28	Q29	Q30				
2	2	4	2	3	3	4	4	3	3	3	1	4				

31.)a)It was to find out if overcrowding affects the average height of the seedlings.  
 b)1: Type of seeds used. 2: Type of soil.

32)Cut all the leaves from the 1<sup>st</sup> plant. Cut only a few leaves from the 2<sup>nd</sup> plant, and leave all the leaves on the 3<sup>rd</sup> plant.

33)a)i,ii)

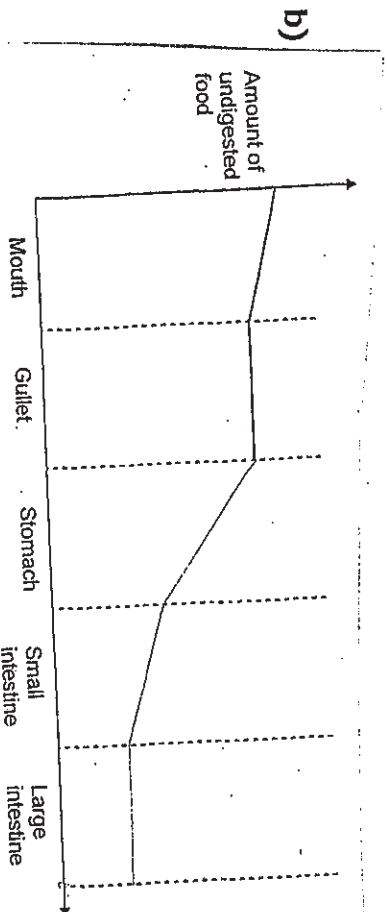
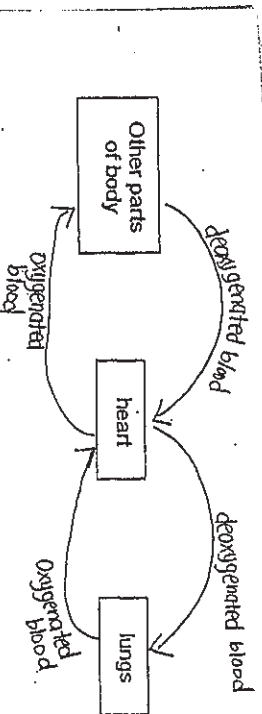

34)a)W: 2 legs      X: 4 legs      Y: More than 4 legs  
 b)There are 3 stages in the life cycle of the animals in Group C, while there are four stages in the life cycle of the animals in Group F.

35)i)The thick fur will trap all the heat thus increasing the polar bear's body temperature beyond the normal range resulting in the polar bear being over heated.

ii)Its black skin will absorb the heat very quickly thus increasing the polar bear's body temperature beyond the normal range resulting in it being over heated.

36)a)X, P

b) $P \rightarrow W \rightarrow Y \rightarrow S \rightarrow R \rightarrow V \rightarrow T$

c)i)now only has limited number of Y to feed on when Y's population decrease thus S will feed more on P leading to a decrease in P's population.

ii)Reduction in population of Y leads to an increase in population of W which will result in decrease of P as W feeds on P.

37)a)The more the amount of rainfall, the more the amount of electricity generated.

b)With minimal rainfall, the amount of water stored behind the dam will be reduced/will be lesser and there is insufficient running water to turn the turbines. This will result in a decrease in the amount of electricity generated.

38)a)The difference in results would be greater, so it easier to make a comparison.

b)Potential energy  $\rightarrow$  kinetic energy  $\rightarrow$  sound energy + heat energy

c)The heavier the weight hung on the parachute, the shorter the time the parachute takes to land.

39)a)3 grandchildren.

b)

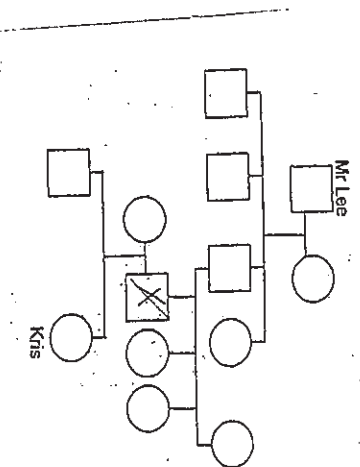

c)Kris' father is affected by the rare disease. Kris inherited the genes from her father, so she is a carrier of the rare disease.

- 40) a) The higher the humidity level, the more the amount of water lost by plants through its stomata.  
 b) Evaporation of water is affected by humidity and the water evaporation will be diff for all 3 set-ups.

41) None

R4, R3, R1

R1, R2

42) a) C, B, A

b)

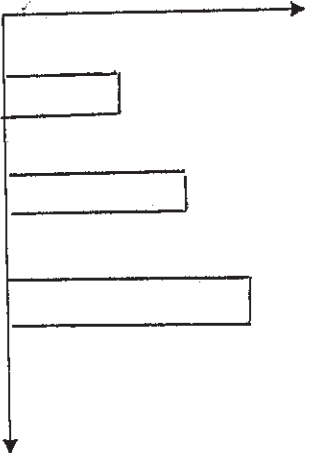

43) a)    B

b) Current move (and carry oil) towards B, but away from A. B will be covered with oil and decrease in population/die but not A.

44) The seedling gets its food from the seed leaves as it grows. This results in a decrease in the mass of the seed leaves but an increase in the height of the seedling.

