

PAYA LEBAR METHODIST GIRLS' SCHOOL (PRIMARY)

**PRIMARY SIX
PRELIMINARY EXAMINATION, 2009**

SCIENCE

Booklet A

NAME : _____

CLASS : P6 _____

DATE : 27 August 2009

TOTAL TIME FOR BOOKLETS A & B : 1 h 45 min

BOOKLET A	/ 60
BOOKLET B	/ 40
TOTAL	/ 100

Parent's Signature: _____

INSTRUCTIONS TO PUPILS

DO NOT OPEN THIS BOOKLET UNTIL YOU ARE TOLD TO DO SO.
Answer all questions.

Section A (30 x 2 = 60 marks)

For each question from 1 to 30, four options are given. One of them is the correct answer. Make your choice (1, 2, 3 or 4). Shade the correct oval (1, 2, 3 or 4) on the Optical Answer Sheet.

1. The diagram below shows two plant parts.

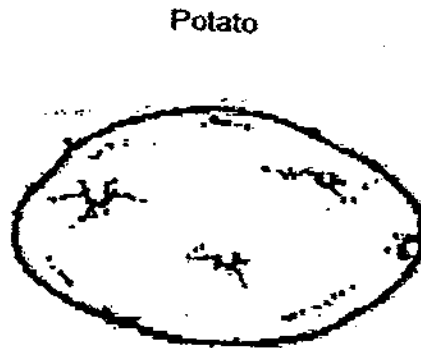

Which of the statements are true about how the plant parts are alike?

- A: They are the reproductive part of the plant.
- B: They go through the process of germination.
- C: They turn iodine blue as they make food for the young plant.
- D: They turn iodine blue as they store food for the young plant.

- (1) A and C only
- (2) A and D only
- (3) B and D only
- (4) A, B and C only

2. The diagrams show the fertilisation of a human egg.

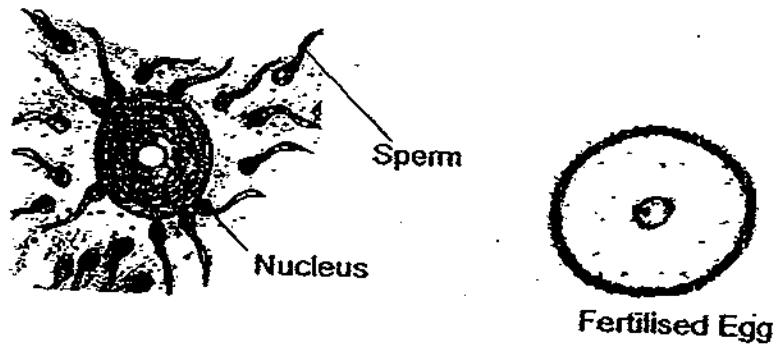

Four statements were made on the above diagrams:

- A: The sperms develop in the testes of the male reproductive system.
- B: The fertilised egg develops in the ovary of the female reproductive system
- C: Usually more than one sperm will enter the egg to increase the chances of fertilisation.
- D: The nucleus of the fertilised egg consists of genetic materials from both the sperm and the egg.

Which of the following statements are true?

- (1) A and D only
- (2) A, B and C only
- (3) A, C and D only
- (4) A, B, C and D

3. The diagram below shows a human skeleton.

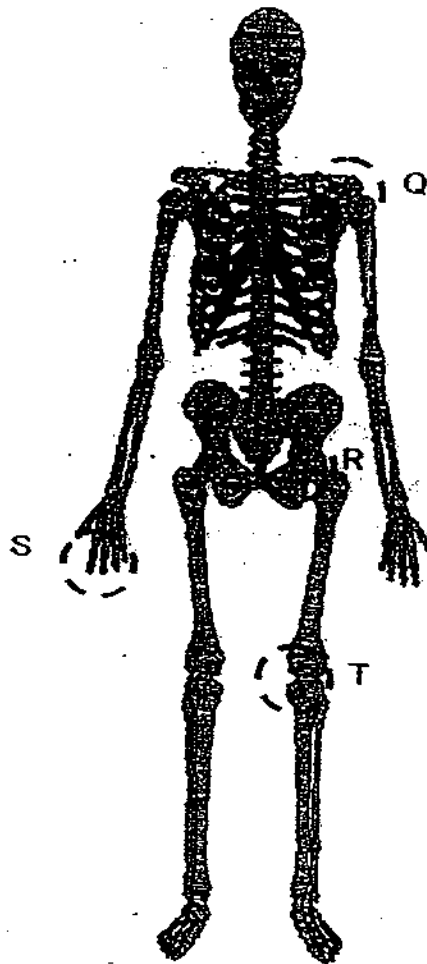

Q, R, S and T represent the different types of joints.

Which one of the following correctly classifies the joints?

	Hinge Joint	Ball and Socket Joint
(1)	Q and S	R and T
(2)	S and T	Q and R
(3)	Q and R	S and T
(4)	R and S	Q and T

4. Study the picture carefully.

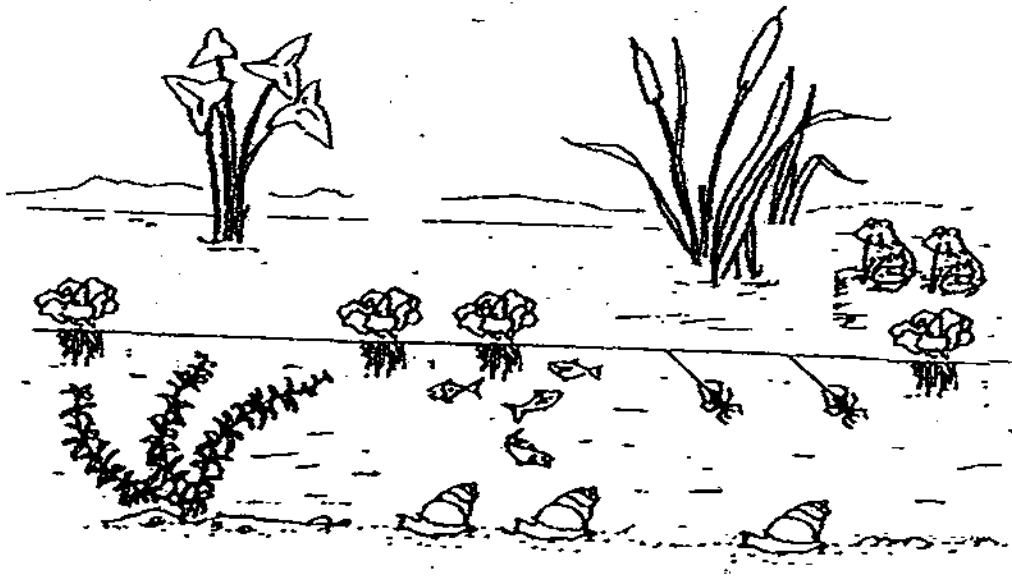

Which of the following best describes the number of community and population of the organisms in the picture?

	Number of Community/Communities	Number of population(s)
(1)	1	8
(2)	1	24
(3)	8	8
(4)	8	24

5. Country X experiences drought every year. During that period, the soil becomes dry and the plants do not grow well to produce enough grain. People do not have enough to eat during this period.

Which is the most effective long term solution to solve this problem?

- (1) Use genetic selection to cross breed parent plants with good genes.
- (2) Use genetic engineering to create grain that has shorter growing period.
- (3) Use micro-organisms to ferment the sugar in the grain and store the energy from the sugar.
- (4) Enrich the soil with earthworms so they build channels in the soil to allow more water reach the soil.

6. The diagram below shows the life cycle of a flowering plant. X, Y and Z represent the important processes that take place at certain stages in the life cycle. More than one process can take place at a stage.

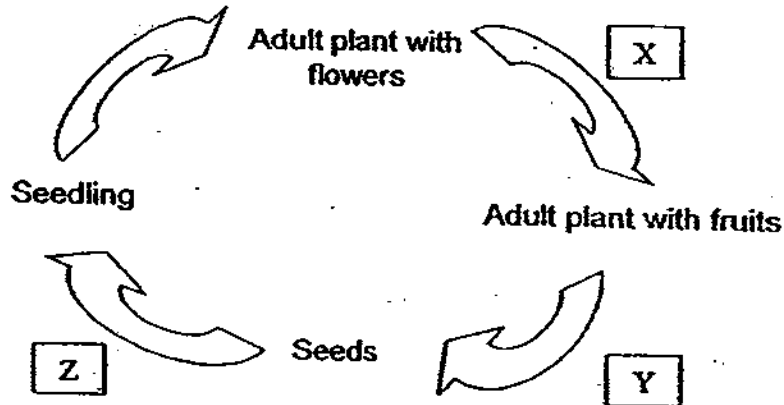

Which of the following table correctly shows processes X, Y and Z?

Process	Letter
Dispersal	✗ X
Pollination	X
Germination	Z
Fertilisation	Y

(1)

Process	Letter
Dispersal	Y
Pollination	X
Germination	Z
Fertilisation	Y

(2)

Process	Letter
Dispersal	Z
Pollination	X
Germination	Z
Fertilisation	Y

(3)

Process	Letter
Dispersal	Y
Pollination	X
Germination	Z
Fertilisation	X

(4)

7. Jean designed two similar set-ups as the one shown below. The type of seed was different in each set-up. One was a set-up with dry seeds while the other one with soaked seeds. The thermometer recorded a temperature of 30 °C. She put both the set-ups in a closed cupboard for 24 hours.

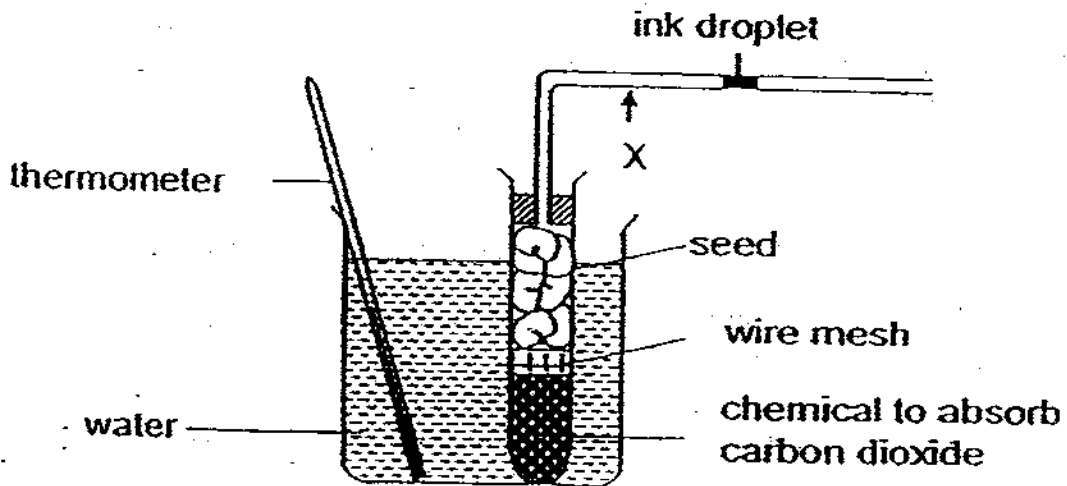

After 24 hours, she removed the set-ups from the cupboard to observe the position of the red ink.

Which of the following statement is true about her observation?

- (1) The red ink will move towards position X in the set-up with dry seeds.
- (2) The red ink will move away from position X in the set-up with dry seeds.
- (3) The red ink will move towards position X in the set-up with soaked seeds.
- (4) The red ink will move away from position X in the set-up with soaked seeds.

Refer to the experiment below to answer questions 8 and 9.

8. Zoey placed 4 similar plants of equal mass into four test tubes, A, B, C and D. She poured an equal volume of water into each test tube. She made a marking on the test tube of the initial water level. She added an equal layer of oil on the water in the test tube. She rubbed Vaseline (oily substance) on the different parts of the leaves on the respective plants as shown below. She left them in a place where the plants could obtain enough sunlight.

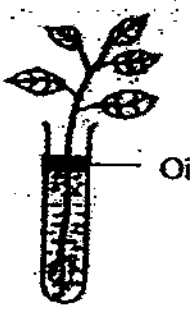
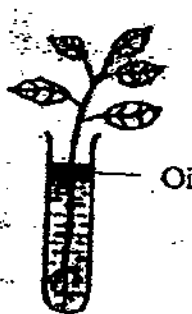
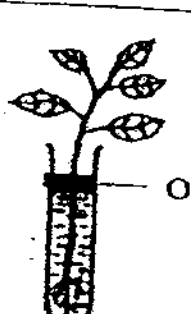
A	B	C	D
			
Vaseline applied on upper surface of leaves	Vaseline applied on lower surface of leaves	Vaseline applied on lower and upper surface of leaves	No Vaseline applied

After four hours, she realised that the water level in all the test tubes were different. Arrange the test tubes to show the highest water level to the lowest water level.

- (1) A, B, C, D
 - (2) B, C, A, D
 - (3) C, B, A, D
 - (4) D, A, C, B
9. What is the purpose of putting a layer of oil over the water in each test tube?
- (1) It is to prevent the amount of water from being lost during respiration.
 - (2) It is to prevent the amount of water from being lost during evaporation.
 - (3) It is to prevent the amount of water from being lost during germination.
 - (4) It is to prevent the amount of water from being lost during photosynthesis.

11. Celine had a plant with some white flowers. She made 3 cuts on different parts of the plant. She first performed **Cut 1** across the stem to observe the cross-section of the stem of the plant. The diagram below shows the cross section of the stem of her plant.

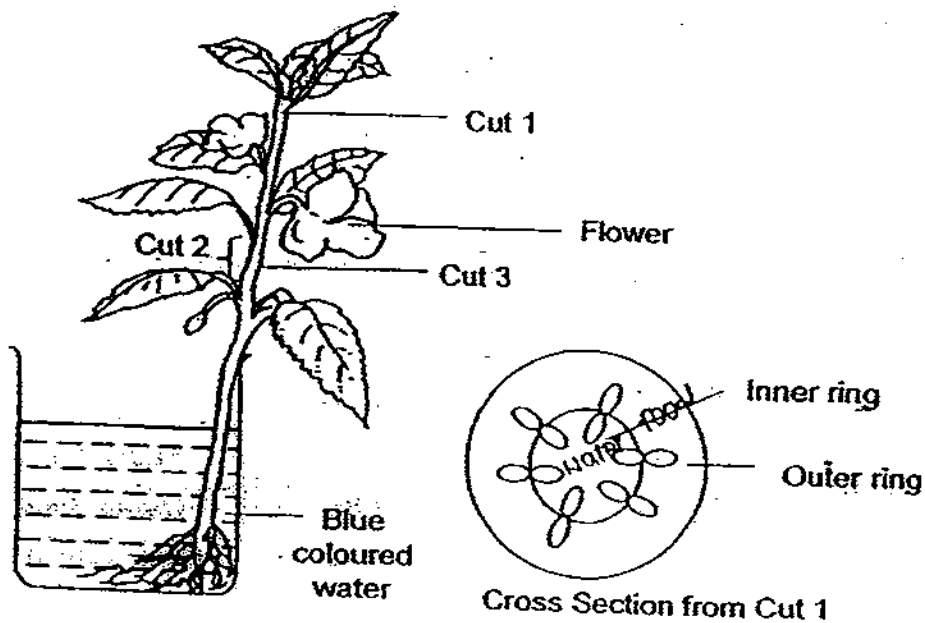

She then performed **Cut 2** to remove the outer ring of a section of the stem as shown above. After that she left the plant in a beaker of blue coloured water for 6 hours.

After 6 hours, she realised her flowers had turned blue. She performed **Cut 3** across the stem, where she had performed Cut 2, to observe another cross section of the stem.

10. The table below shows some functions of adaptations belonging to some animals.

Adaptation	Function
A	To breathe in water
B	To move easily in water
C	To protect itself from predators
D	To move on slippery ground

Which one of the following correctly matches the functions of the adaptations above?

	Adaptation A	Adaptation B	Adaptation C	Adaptation D
(1)	Skin	Tail fins	Shell	Padded feet
(2)	Gill Chamber	Flippers	Shell	Oar-like feet
(3)	Gills	Streamlined body	Spines	Feet with stiff hair
(4)	Blowholes	Streamlined body	Camouflage	Webbed feet

Which of the following shows the cross section of the stem that she observed at Cut 3?

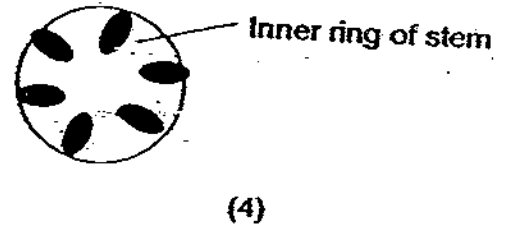
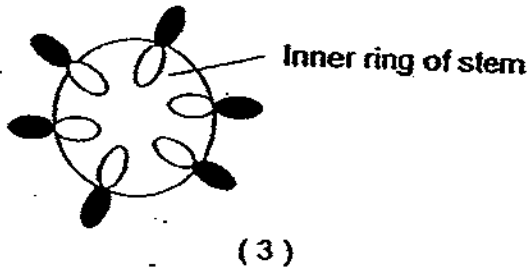
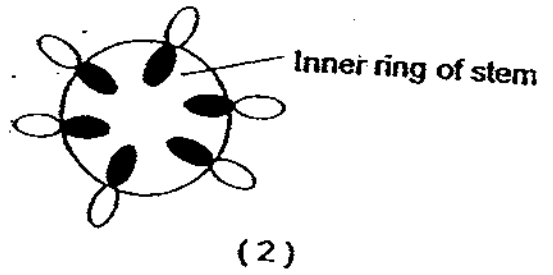
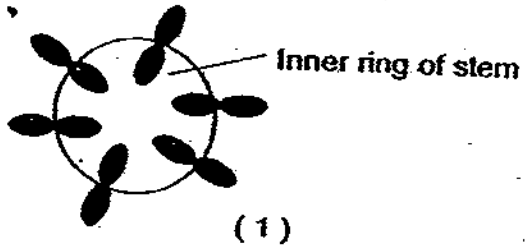

12. The diagrams below show the dispersal of fruits by Plants P, Q and R.

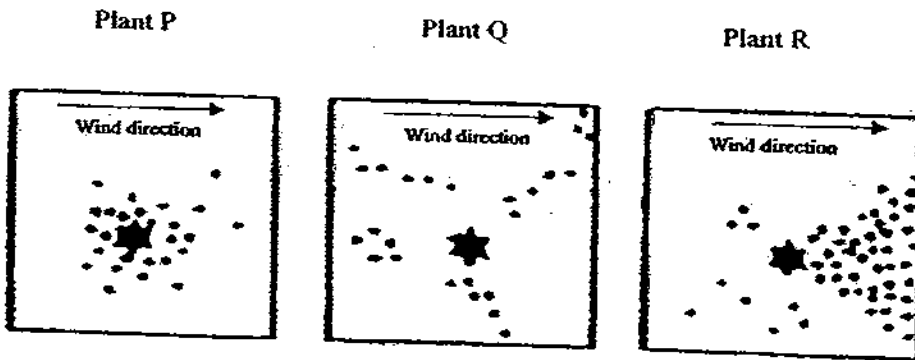

Study Fruits A, B and C carefully.

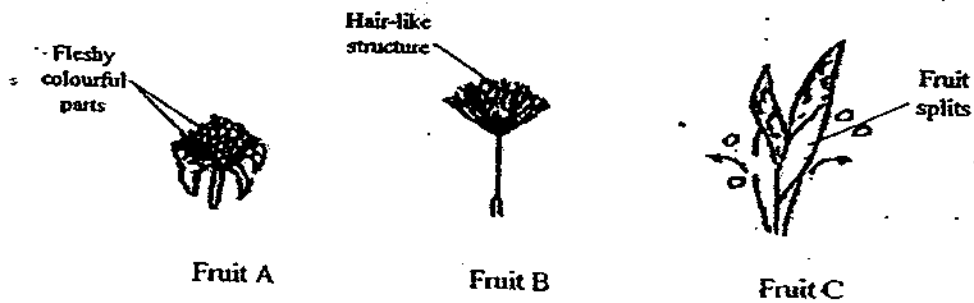

Which one of the following shows the correct fruit of Plants P, Q and R?

	Plant P	Plant Q	Plant R
(1)	Fruit A	Fruit B	Fruit C
(2)	Fruit B	Fruit A	Fruit C
(3)	Fruit C	Fruit A	Fruit B
(4)	Fruit C	Fruit B	Fruit A

13. The picture below shows an important part of a system in the plant and fish.

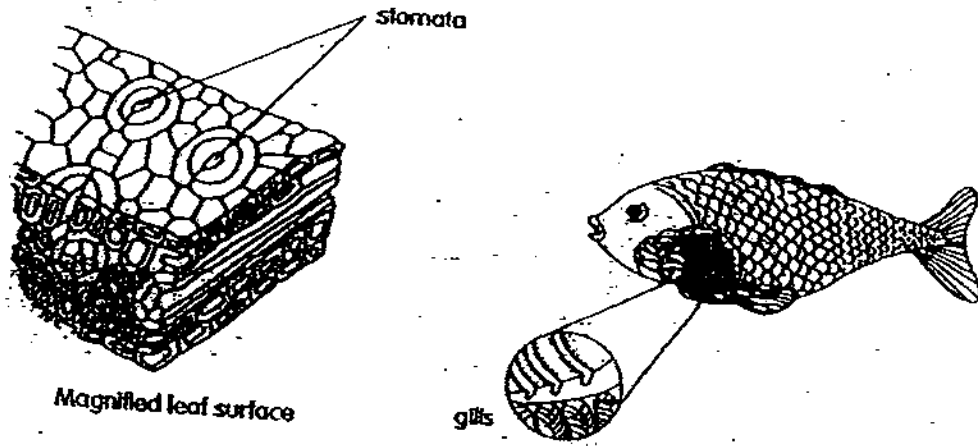

Hamid makes some statements about the stomata and gills.

- A: The plant loses water through its stomata during photosynthesis.
- B: Both the stomata and gills are part of the respiratory system of the organism.
- C: Both the stomata and gills are part of the circulatory system of the organism.
- D: The function of the gills is to carry out gaseous exchange for respiration to take place in the fish.

Which are the correct statements?

- (1) A and B only
- (2) B and D only
- (3) B, C and D only
- (4) A, C and D only

14. L, M, O, P and Q are different organisms found in a community. The following statements provide information about these living things.

P is a food producer
L and Q feed on P
O feeds on L
Q and O are eaten by M.

Which of the following best describes the interdependence of the organisms in a food web?

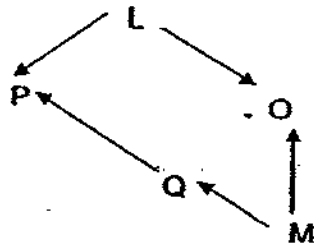

(1) ✗

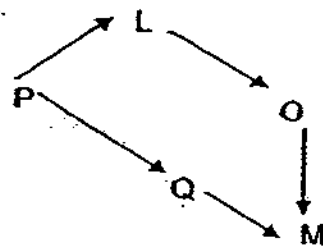

(2)

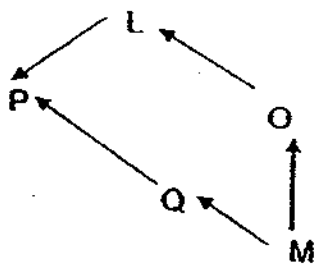

(3) ✗

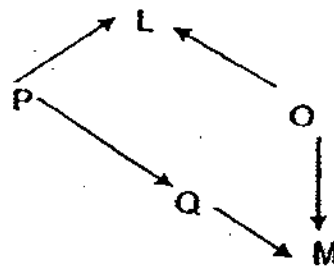

(4)

15. The diagram of the heart shows the different blood vessels that carry blood to it and away from it. Blood vessels A and D carry blood to the heart. Blood vessels B and C carry blood away from the heart.



The following bar chart shows the amount of oxygen in 4 different blood samples P, Q, R and S. These blood samples are taken from each blood vessel as indicated in the heart above.

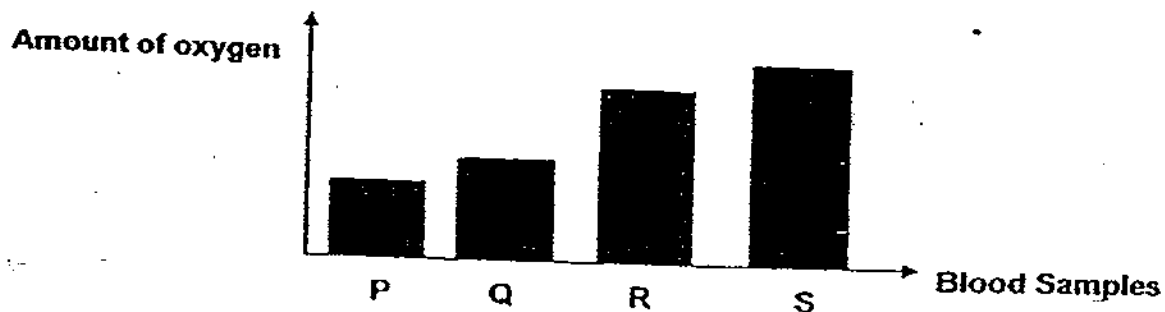

Which of the following samples corresponds to the blood vessel that carries most waste products of respiration?

	Blood Sample	Blood Vessel
(1)	P	B
(2)	Q	A
(3)	R	D
(4)	S	C

16. Farmer Tan grew many plants S in his farm. He noticed insects T visiting the flowers of plants S. He started using pesticide to kill them. After a period of time, he found out that the number of plants S had decreased.

Which of the following graphs best explains the interaction between insects T and plants S based on his findings?

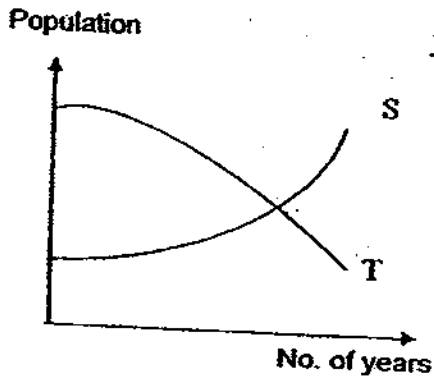

(1)

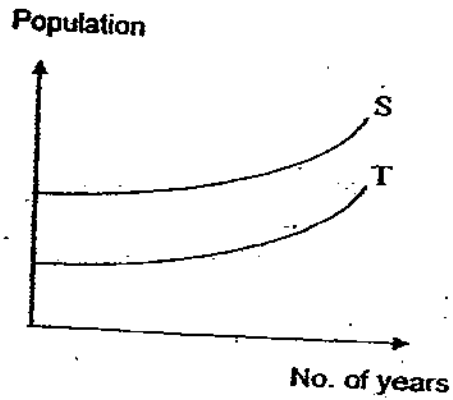

(2)

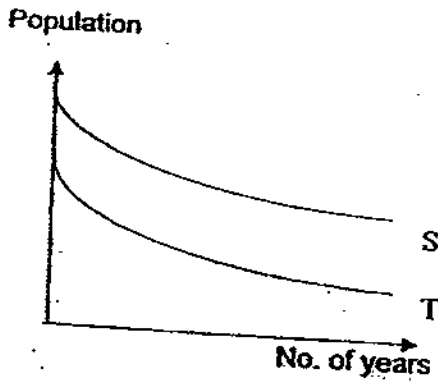

(3)

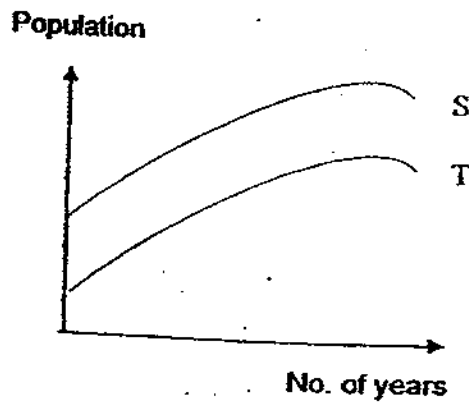

(4)

17. Siti filled up a 100 cm³ beaker with water. She filled up another 100 cm³ beaker with small marbles. Next, she transferred both the water and the marbles into a 250 cm³ beaker.

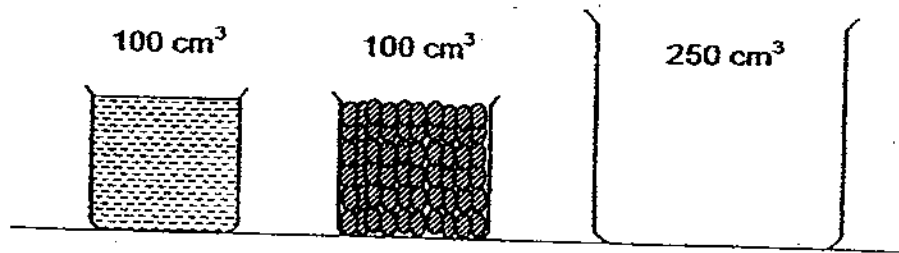

The volume occupied by the water and the marbles in the beaker is likely to be

- (1) 100 cm³
 - (2) 200 cm³
 - (3) more than 200 cm³
 - (4) between 100 cm³ and 200 cm³
18. Study the set-up below.

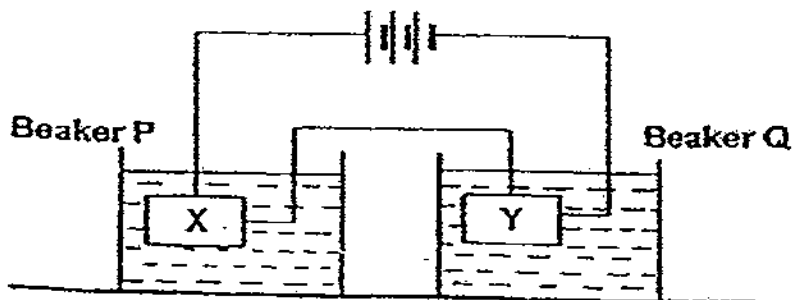

The temperature of water in both beakers is 30°C at the start of the experiment. Two objects, X and Y were placed into the water in beakers, P and Q respectively. Which one of the following show the observation made after 15 minutes?

	Object X	Temperature of water in P (°C)	Object Y	Temperature of water in Q (°C)
(1)	Satay stick	30	Steel rod	50
(2)	Metal spoon	45	Plastic fork	45
(3)	Iron plate	40	Nichrome rod	60
(4)	Wooden chopstick	30	Toothpick	40

19. Study the classification chart below.

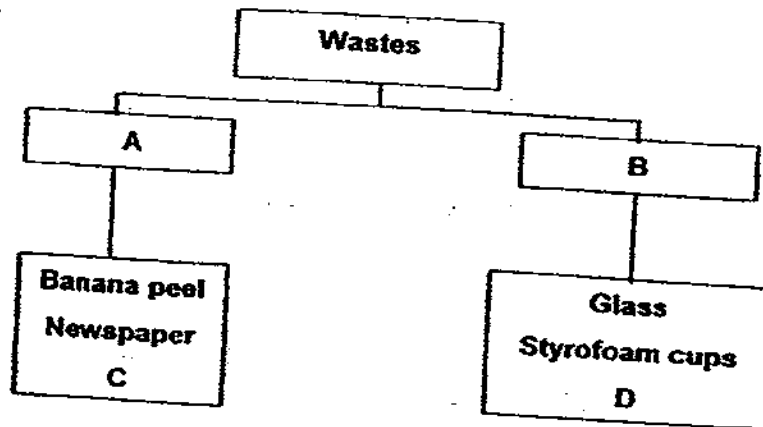

Which of the following is likely to be A, B, C and D?

	A	B	C	D
(1)	Recyclable	Non-recyclable	Chicken bone	Paper Plate
(2)	Non-recyclable	Recyclable	Plastic bottle	Aluminum can
(3)	Biodegradable	Non-biodegradable	Chicken bone	Plastic bottle
(4)	Non-biodegradable	Biodegradable	Aluminum can	Paper plate

20. The following diagram shows three similar sticks, A, B and C, placed at different positions in front of the screen. An even light source was switched on and the shadows of the A, B and C, are cast on the screen.

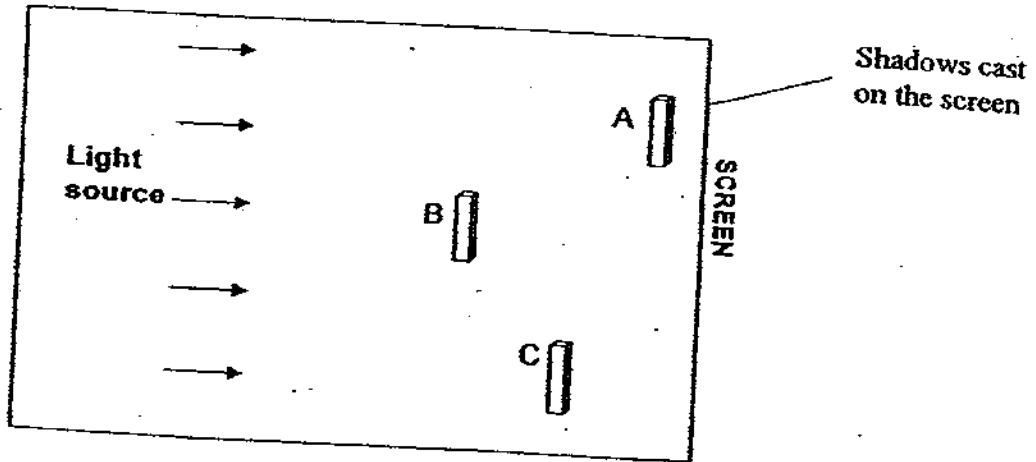

Which one of the following shows the correct shadows of the sticks, A, B and C, cast on the screen?

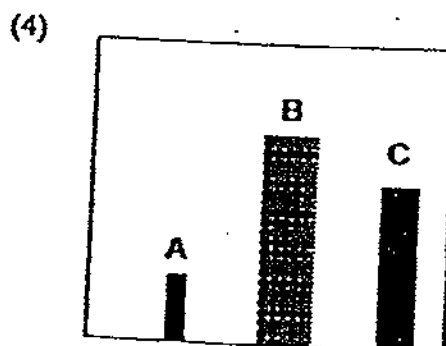
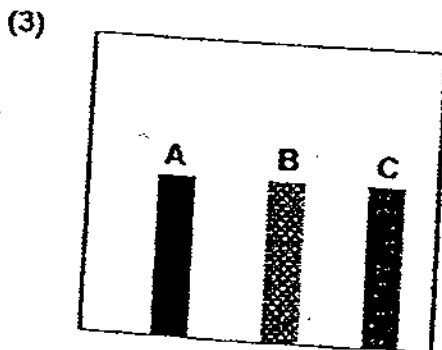
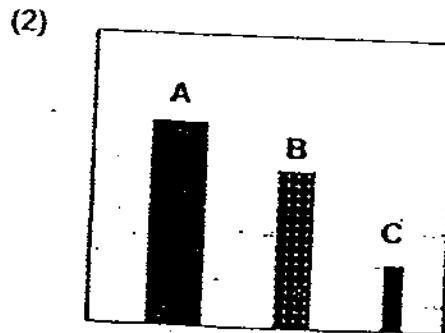
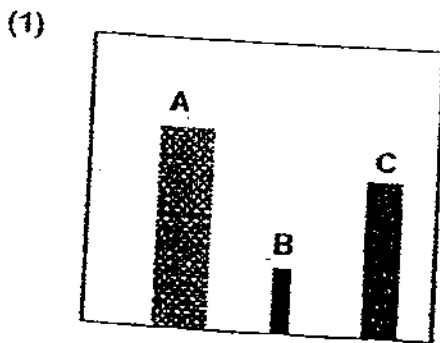

21. Three containers, A, B and C, are set up as shown below. Container A is made of the best conductor of heat while container B is the poorest conductor of heat. All three containers are of the same size and thickness.

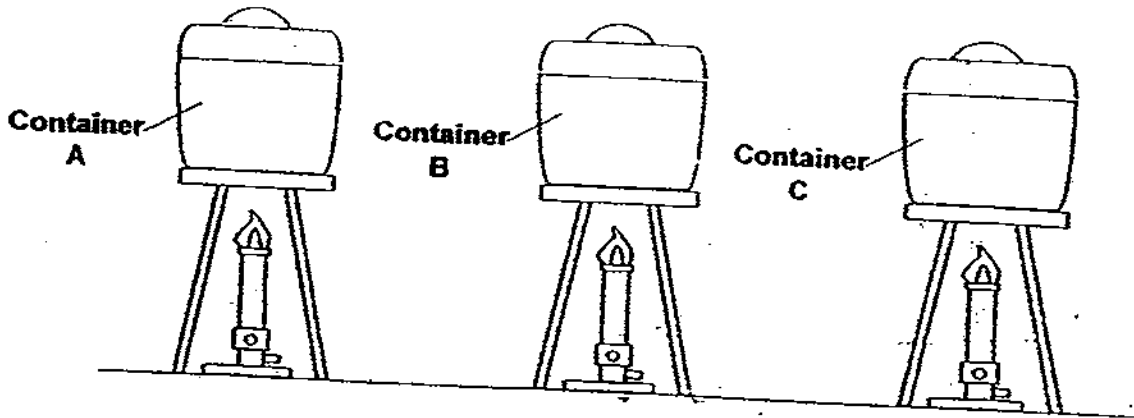

Different amounts of water was poured into each container and heated over three similar flames. The water in them boiled at the same time. What could be the possible amount of water in containers A, B and C at first?

Amount of water (ml)			
	A	B	C
(1)	250	750	500
(2)	250	500	750
(3)	750	500	250
(4)	750	250	500

22. Jeremiah has 4 similar objects, D, E, F and G. He cannot remember the mass of each object but previous records show that their masses are 420g, 350g, 240g and 150g. He uses a balance to compare their masses to help him match the correct mass to each object.

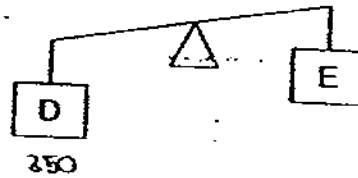
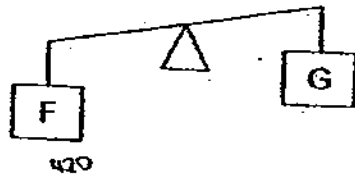
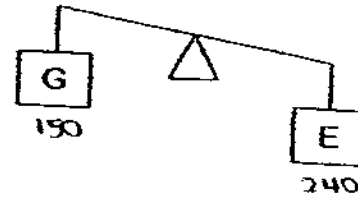
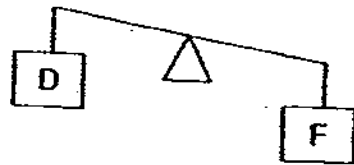

What is the mass of object E?

- (1) 150g
- (2) 240g
- (3) 350g
- (4) 420g

23. Four metal balls, A, B, C and D, are suspended on a string from the ceiling. The four balls are cut and dropped from different heights as shown in the diagram below. Each ball created a depression on a slab of plasticine below them when each was dropped from the height as shown below.

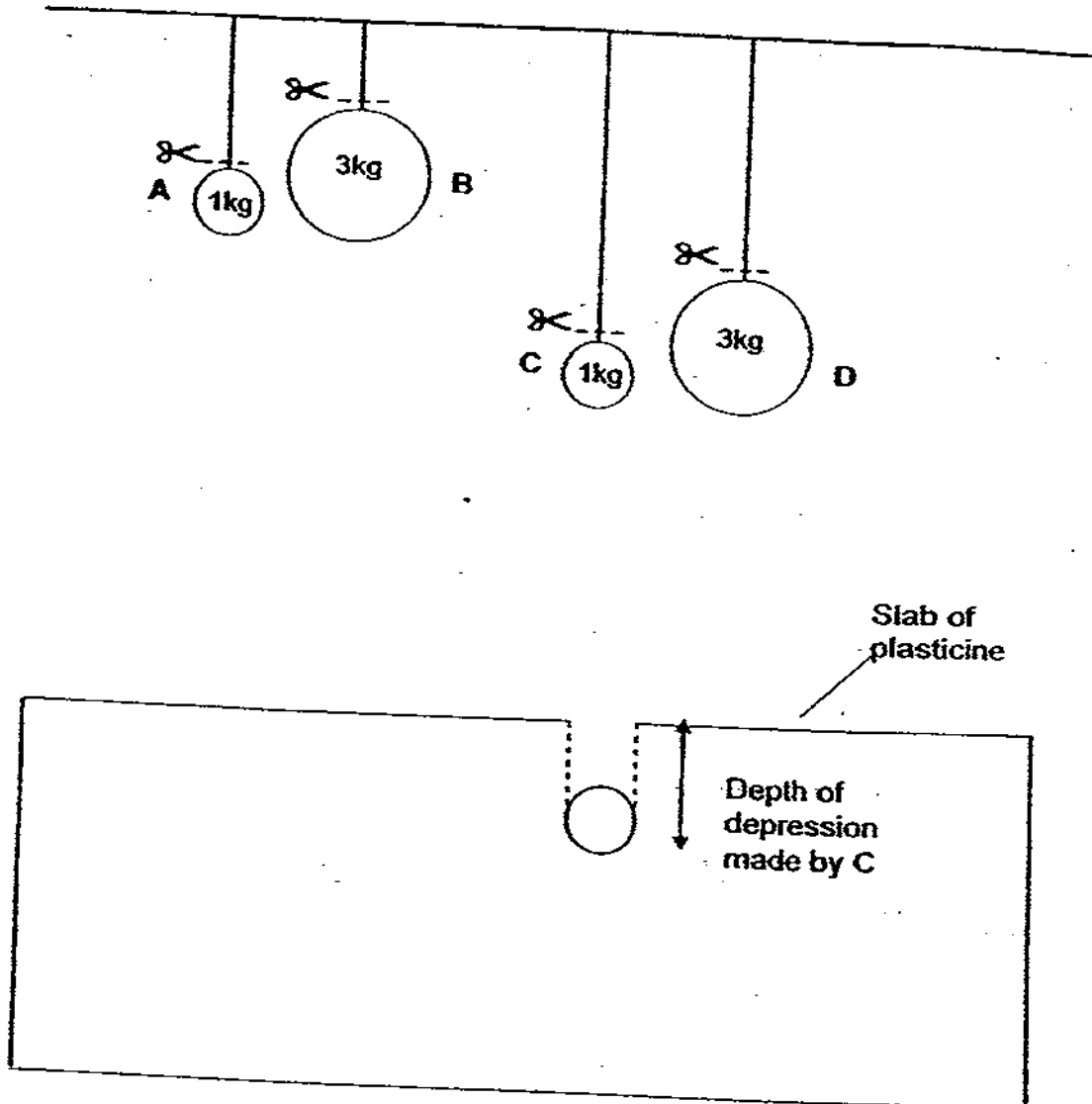

Which of the graphs below shows the most possible depth of the depressions made by the four metal balls A, B, C and D?

(1)

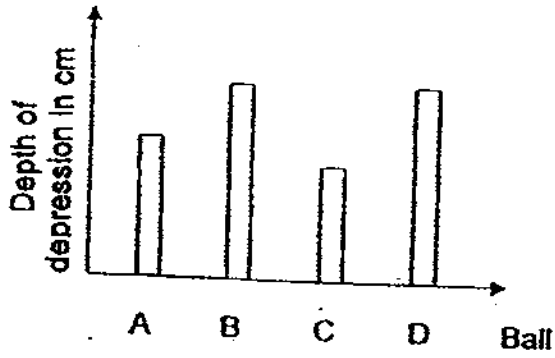

(2)

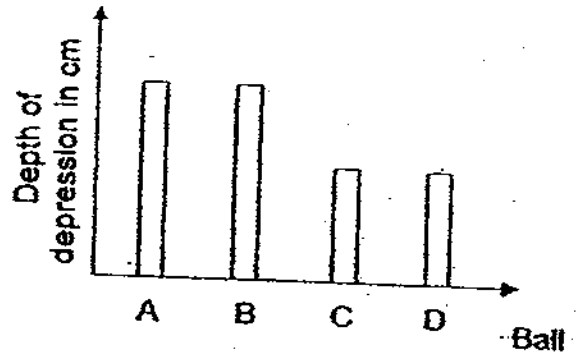

(3)

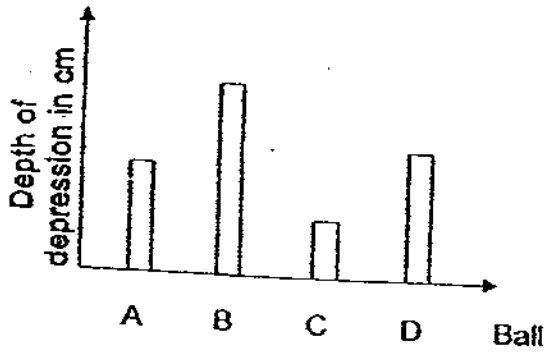

(4)

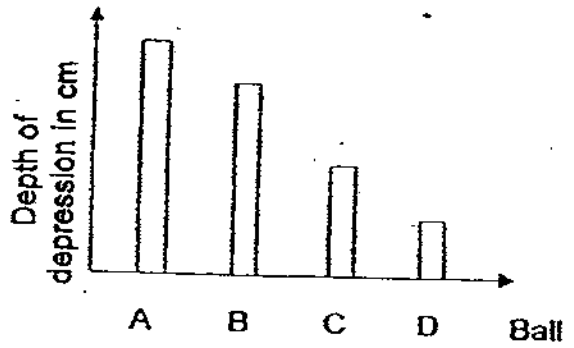

24. Study the classification chart below carefully.

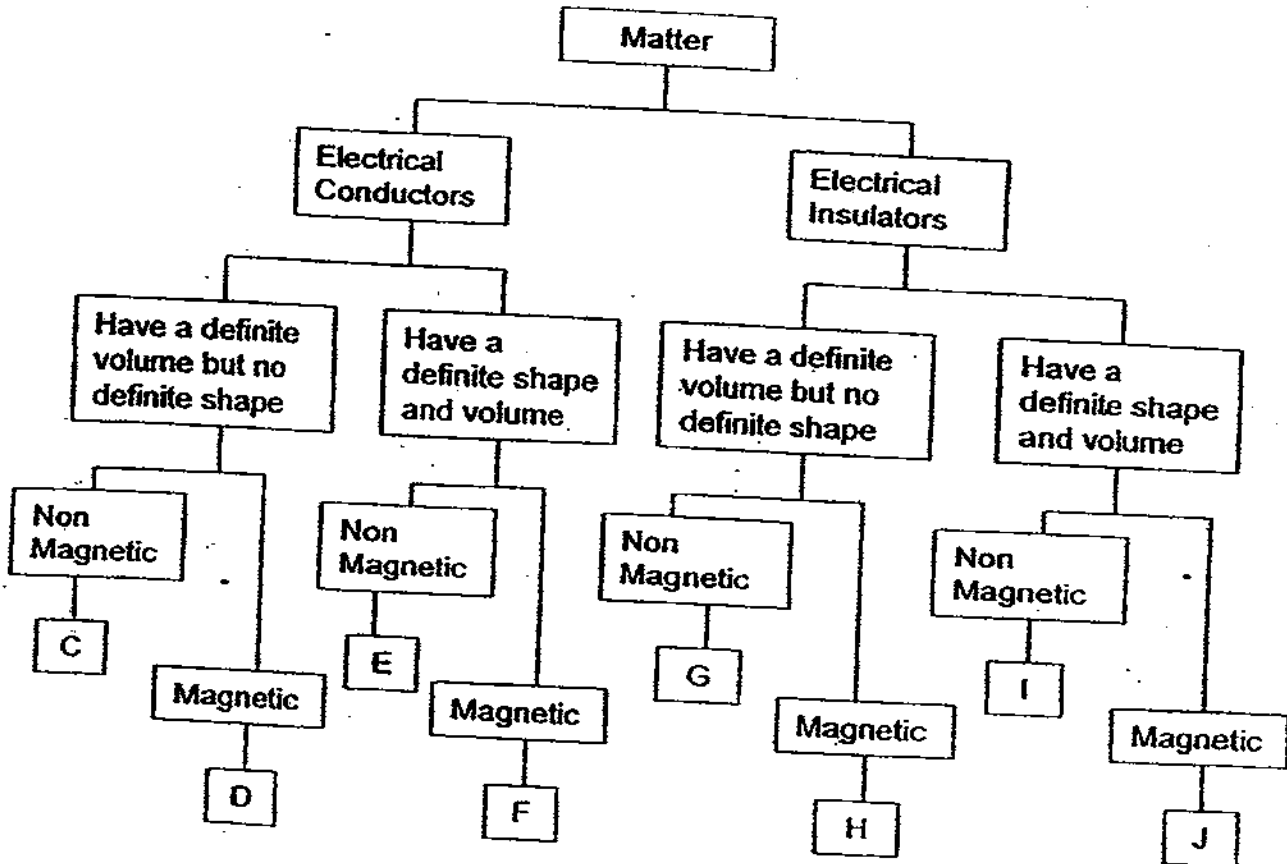

Which of the following correctly identifies the matter-given?

	Oil	Iron Rod	Aluminium Foil	Porcelain Cup
(1)	C	D	E	J
(2)	E	H	J	F
(3)	G	C	I	J
(4)	G	F	E	I

25. Some Primary 6 pupils used each of the four simple machines as shown below to move a load of 20kg.

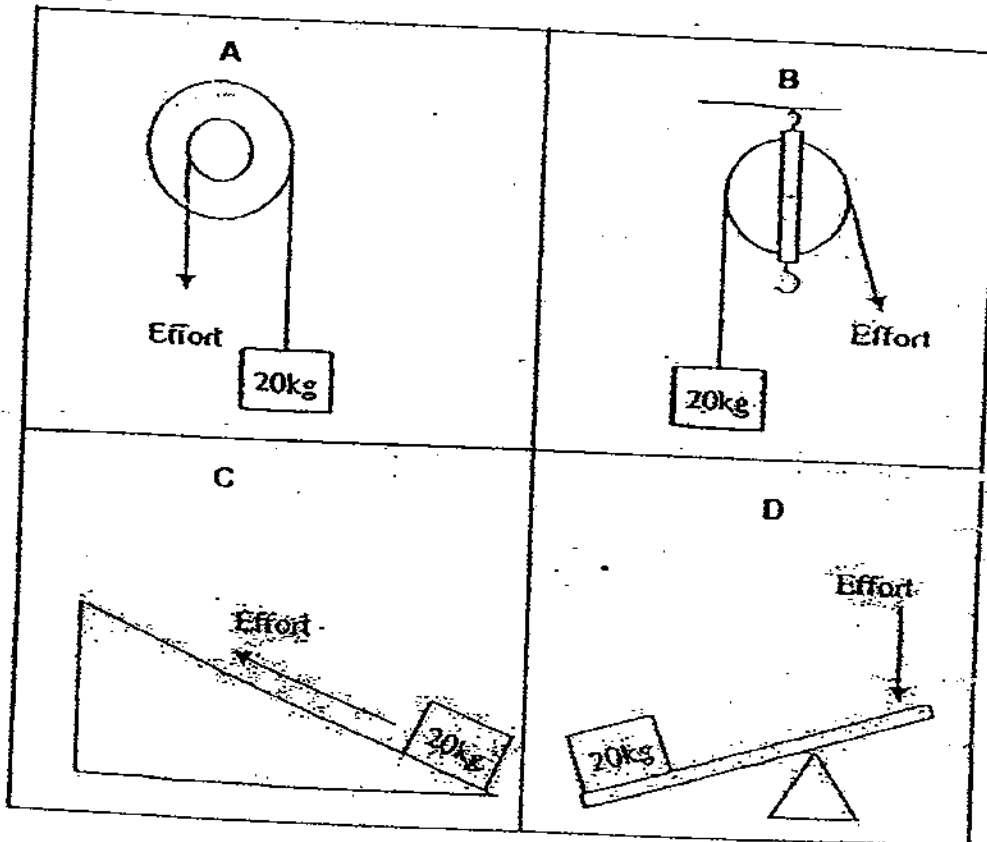

Which of the machines required the pupils to use an effort of at least 20kg?

- (1) A and D only
- (2) C and D only
- (3) A, B and D only
- (4) A, B, C and D

26. Sally is given four new materials, P, Q, R and S. Each of these substances has its own properties shown in the table below.

Material	Melting Point (°C)	Boiling Point (°C)	Breaks easily when hit	Does not break easily when hit
P	0	68		√
Q	10	200		√
R	190	450		√
S	335	655	√	

Sally is making a decision to choose a durable material to make the heating coil in a kettle.

Based on the information given above, which material, P, Q, R and S, should she choose?

- (1) P
- (2) Q
- (3) R
- (4) S

27. A circuit was set up as shown in the diagram below. The bulb did not light up.

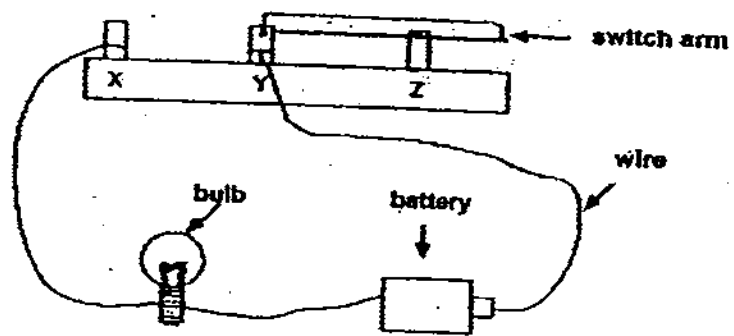

What can be done to light up the bulb?

- A. Move the wire from Y to Z.
- B. Position the switch arm at XY instead of YZ.
- C. Connect one end of the wire to the metal tip of the bulb.

- (1) A only
- (2) A and B only
- (3) B and C only
- (4) A, B and C

28. Nadia had three rods, X, Y and Z, made of different materials. She placed them in positions as shown in the circuit below. All the bulbs, batteries and wires are in working condition.

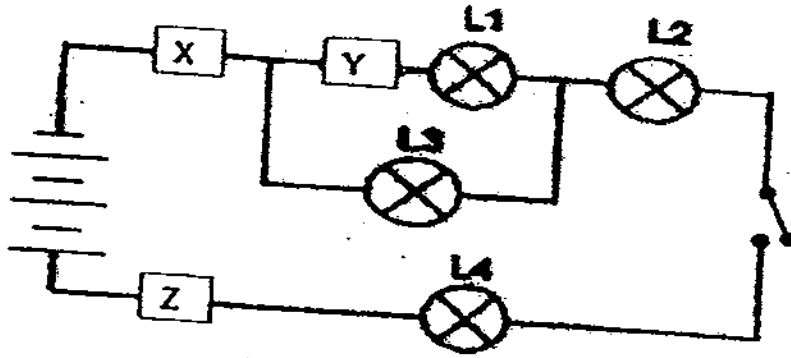

The bulbs, L2, L3 and L4, lit up during the experiment.

Based on the results given, what materials were rods X, Y and Z likely to be made of?

	X	Y	Z
(1)	Copper	Ceramic	Glass
(2)	Aluminium	Glass	Copper
(3)	Rubber	Plastic	Steel
(4)	Copper	Rubber	Ceramic

29. Study the diagram below.

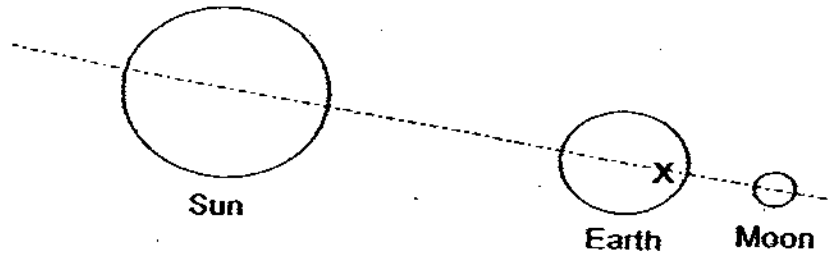

Which of the following shows what the Moon looks like when a person views it from point X?

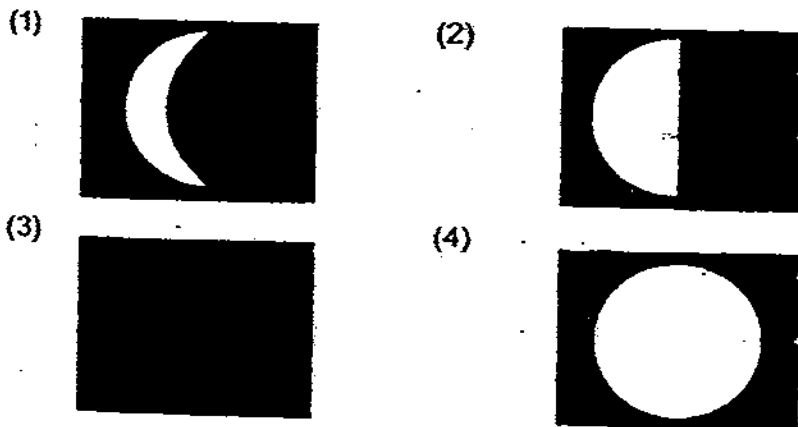

30. In a hydro-electric power station, running water is used to produce electricity. Which of the following statements correctly describes the processes that take place in a hydro-electric power station?

- A: The water behind the dam possesses gravitational potential energy.
- B: Water is being heated to form steam in order to produce electrical energy.
- C: The kinetic energy of running water is converted to electrical energy.
- D: The running water cools the steam to produce more water to turn the turbine.

- (1) A and C only
- (2) B and D only
- (3) A, B and D only
- (4) A, C and D only

PAYA LEBAR METHODIST GIRLS' SCHOOL (PRIMARY)

**PRIMARY SIX
PRELIMINARY EXAMINATION, 2009**

SCIENCE

Booklet B

NAME : _____ ()

CLASS : **P6** _____

DATE : **27 August 2009**

TOTAL TIME FOR BOOKLETS A & B : 1 h 45 min

Total Marks (Section B)	/ 40
--------------------------------	-------------

Parent's Signature: _____

INSTRUCTIONS TO PUPILS

DO NOT OPEN THIS BOOKLET UNTIL YOU ARE TOLD TO DO SO.

Answer all questions.

SECTION B: 40 Marks

For questions 31 to 46, write your answers in the spaces provided. The number of marks available is shown in brackets [] at the end of each question or part question.

31. The diagrams below show specimen cells A and B found in two different parts of plant as seen under the microscope. Observe them carefully and answer the questions that follow.

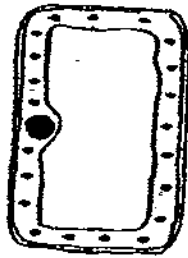

Specimen Cell A



Specimen Cell B

- (a) Based on the diagrams, state the part of the cell that is different between Specimen Cell A and Specimen Cell B. [1]

- (b) Which part of the plant is Specimen A usually found? [1]

32. The flow chart shows how energy to do work is obtained from food.

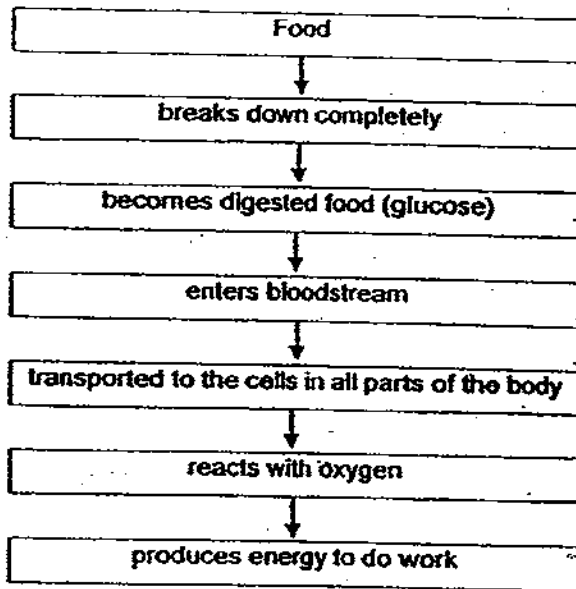

(a) Using the information in the flow chart, identify the systems in our body that work together for energy to be released from food. [1]

Shauna saw a can of energy drink on the shelf of a supermarket. The label on the drink read "Quick Energy". She did not understand how the drink could provide quick energy. She turned to look at the ingredients of the drink.

Ingredients: Water, Glucose, Calcium, Vitamin D.

(b) Identify the ingredient that provides 'Quick Energy'? [1]

(c) Explain how the ingredient is able to provide 'Quick Energy'. [1]

33. Simon was doing a research on the human respiratory system. He discovered that numerous thin blood vessels surrounded the air sacs in the lungs.

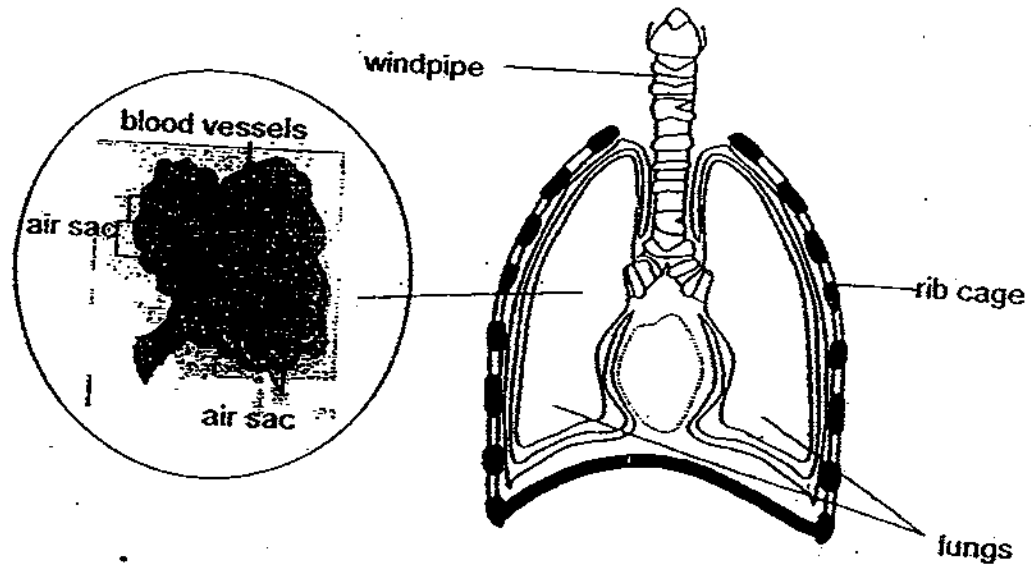

- (a) Why are the walls of the blood vessels around the air sac very thin? [1]

In his study of the topic, '*The Heart- A Muscular Pump*', Simon learnt that the walls of some blood vessels, like arteries, that carry blood to all parts of the body are very thick. He asked his friend who carried out an investigation on three different grades of balloon of different thickness to explain to him the purpose of a thick wall in an artery.

Method:

1. Observe the thickness of the skin of the balloon and record it in a table.
2. Exhale into each of the three balloons five times.
3. Measure the diameter of the balloons and record it.

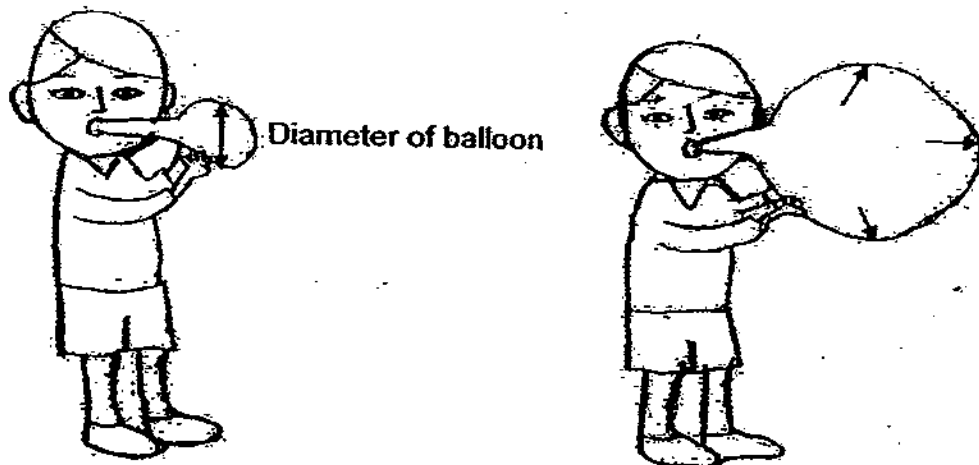

Before

After exhaling

Results:

Grade of Balloon	Thickness of balloon (cm)	Diameter of balloon (cm)
A	0.1cm	Could not record (Bursts)
B	0.3 cm	15 cm
C	0.5cm	7cm

(b) Based on the results, explain why the wall of the artery that carries blood from the heart to the body is thick? [1]

34. Jeryl set-up an experiment as shown below. She left the set-ups in the Science laboratory for 2 hours.

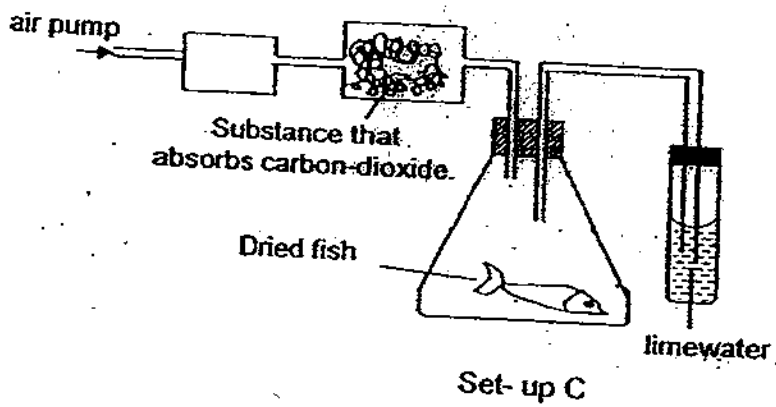
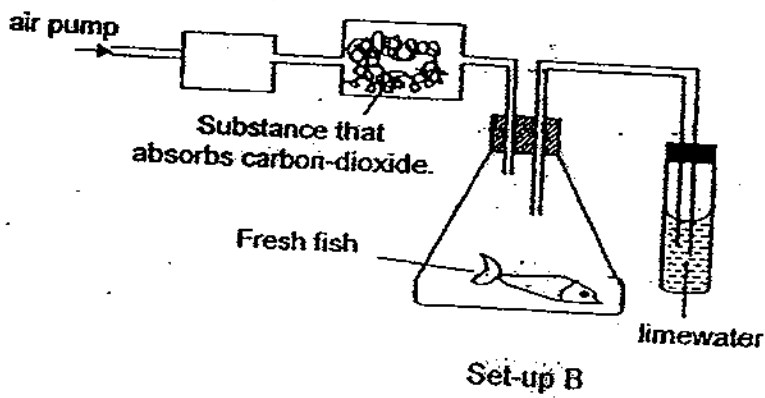
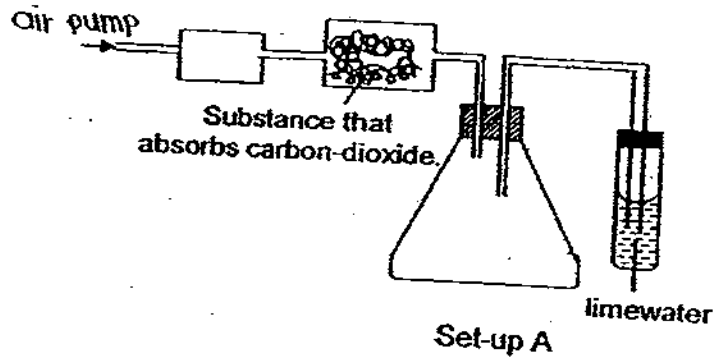

(a) In which Set-up will limewater be most chalky after two hours? Why? [2]

(b) How does the substance that absorbs carbon-dioxide make the experiment an accurate one? [1]

35. Study the food chain below.

maize plant → rat → snake → eagle

(a) The letters A, B, C and D on the pyramid represent the number of living things in the above food chain.

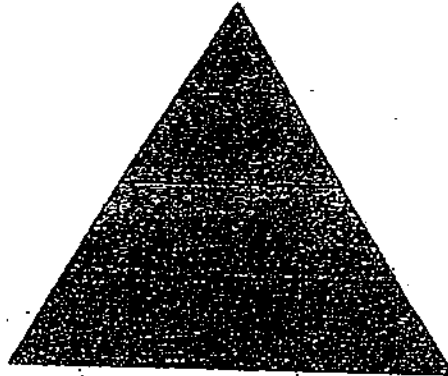

Identify the letters in the pyramid that belong to the respective living things in the food chain above. [2]

Maize Plant	Rat	Snake	Eagle

- (b) The farmer decides to set rat traps to kill the rats in his field as they are destroying his maize plants. The graph below shows the effect of the death of the rats on the other living things in the food chain.

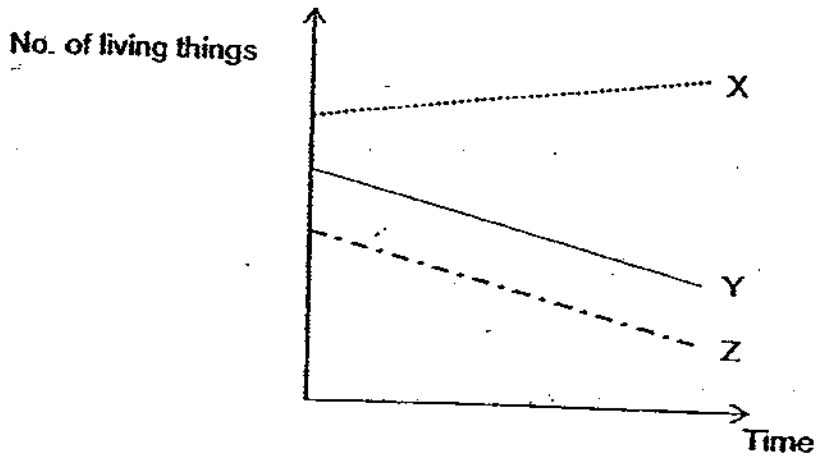

Identify Animals X and Y of the food chain represented in the graph above. [1]

X: _____

Y: _____

- (c) Suggest a way how the farmer could use biotechnology instead of rat traps to help him protect his crops from rats. [1]

36. The diagram below shows bird Q. This bird is found in country R that experiences short summers and long winters. They swim in the water to source for their food. However, it is found in the rich mudflats of Sungei Buloh Nature Reserve in Singapore between September and March when its origin country experiences cold winter.

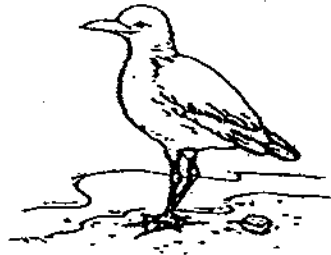

- (a) The diagram below shows three examples of the structure of some birds' feet.

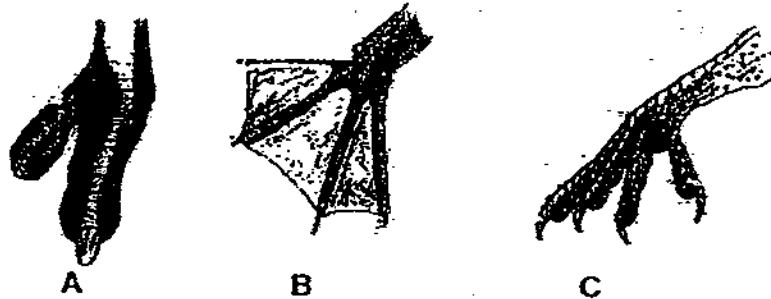

Based on the information given above about bird Q, which one of the above foot structures do you think it most likely has? Why? [1]

- (b) Based on the information above, explain a behavioural adaptation that bird Q adopts. [1]

In a particular year, a serious oil spill took place in the waters of Bird Q's origin country of R. That year, Sungei Buloh, did not have many birds Q visiting it.



(c) Based on the diagram, explain how the oil spill resulted in the low numbers of birds Q in Sungei Buloh. [1]

37. The diagram below shows the water cycle. Processes in the water cycle involve either a heat gain or heat loss. Write down 'heat gain' or 'heat loss' in the boxes where a change in state of water occurs. [1]

(a)

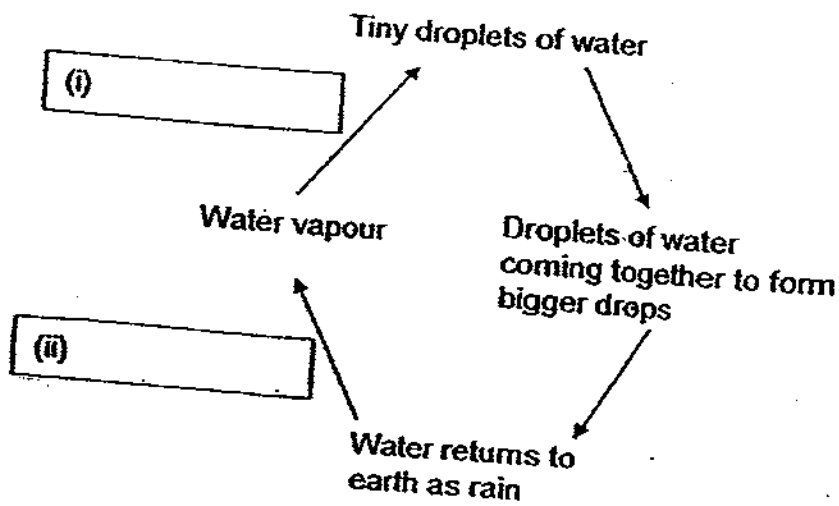

Ravi left the set-up below in a basket ball court to investigate the effect of the presence of plants on the water cycle. A day later, he collected 5ml of water in the cup.

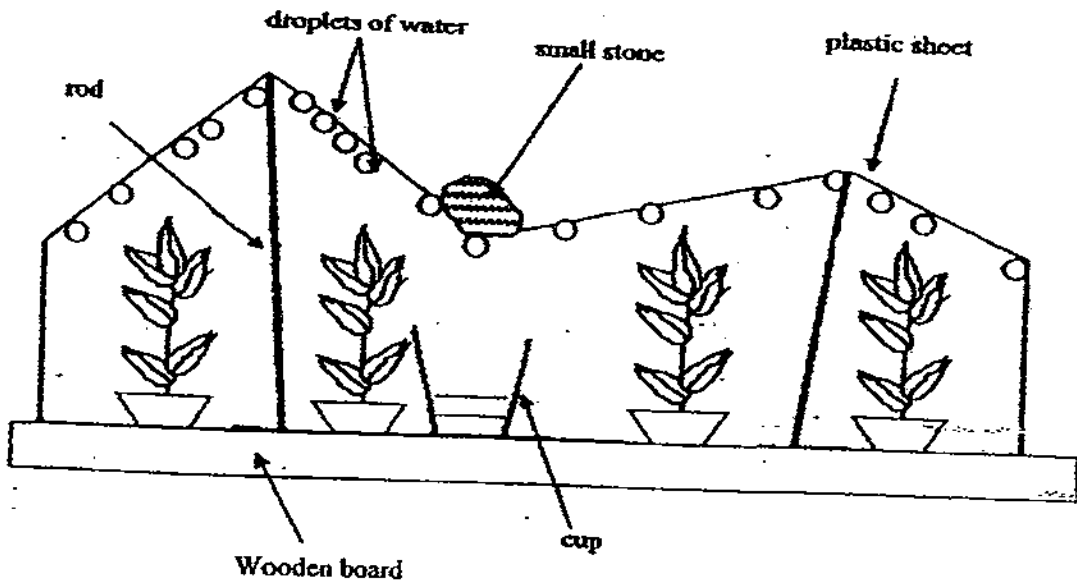

- (b) His friend told him to prepare another similar set-up like the one above, without the potted plants. He then asked him to leave it in the same basket ball court. He told him that the set-up without the potted plants acts as a control. Explain how it acts as a control? [1]

38. Gopal filled Jar A completely with gas X which is brown in colour. An identical jar, Jar B, was separated from Jar A with a cardboard in between. When Gopal removed the cardboard, gas X spread from Jar A to Jar B.

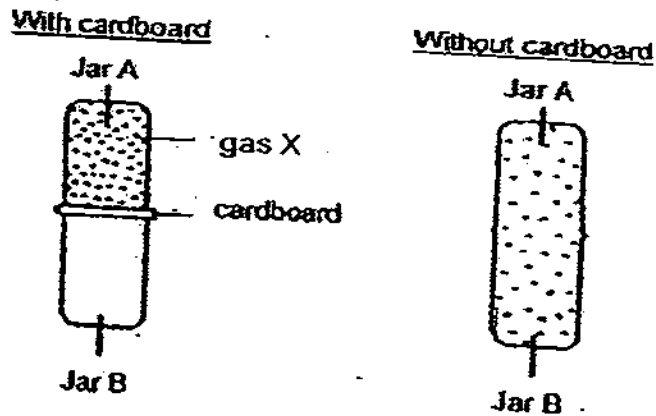

- (a) What does this experiment tell Gopal about the volume and shape of gaseous matter? [1]

- (b) Give a reason why Gopal did NOT choose a colourless gas for this experiment? [1]

39. Complete the diagram below by drawing wires and **two** switches, A and B, so that the following observations can be observed. **Label** the switches (⤵), A and B in the diagram. [2]

Switch	Bulb/s that light/s up when the switch is closed
Close A only	Bulb 1 only
Close B only	Bulb 2 and Bulb 3

Power Supply

Bulb 1



Bulb 2



Bulb 3



40. Winifred wanted to investigate if the thickness of a copper bar would affect the brightness of a bulb in an electrical circuit. She set up 3 circuits as shown below. The thickness of each bar is indicated below each diagram.

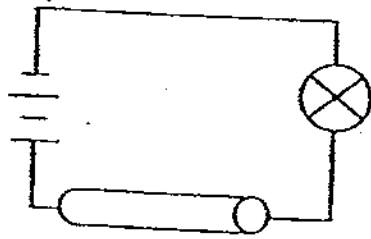

Set-up A
 (length of copper bar: 4 cm)
 (thickness of copper bar: 1 cm)

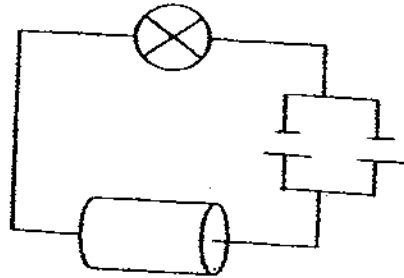

Set-up B
 (length of copper bar: 3 cm)
 (thickness of copper bar: 3 cm)

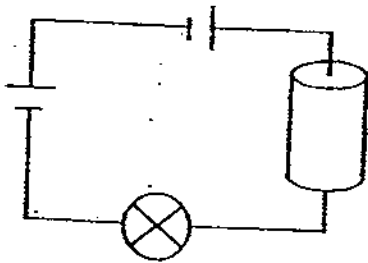

Set-up C
 (length of copper bar: 3 cm)
 (thickness of copper bar: 3 cm)

(a) Osman told Winifred that her experiment would not work as it is not a fair test. What should Winifred do to improve her set-ups? [2]

(b) What can Winifred do to ensure the accuracy of her experiments? [1]

41. Sheila arranged five magnets to form the figure shown below.

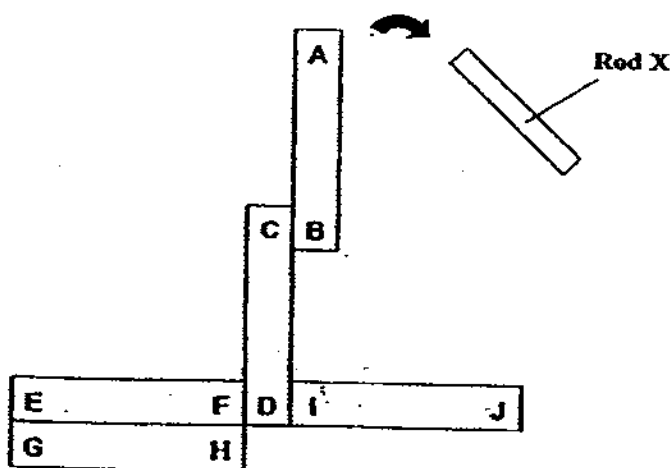

(a) If part A is a North pole, which pole is part G? [1]

(b) The diagram below shows how Sheila tried to move the iron nail from the base of the container to its brim by pulling a bar magnet along the side of the container.

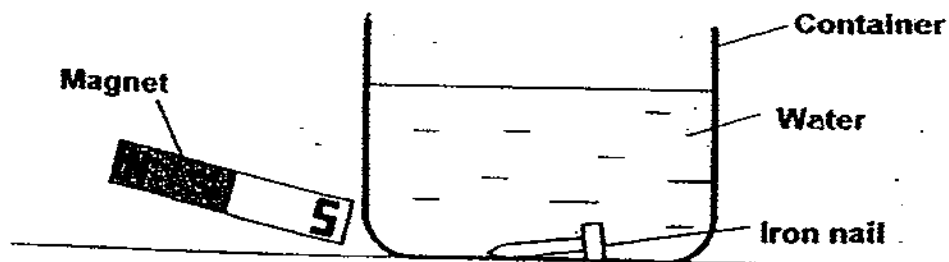

She found that she could not move the iron nail. State two possible reasons why she could not move the iron nail. [2]

Reason 1	
Reason 2	

42. The diagram below shows two similar 3-litre beakers, A and B, holding the same amount of water at first. The water is then allowed to flow out from the hole made in each beaker.

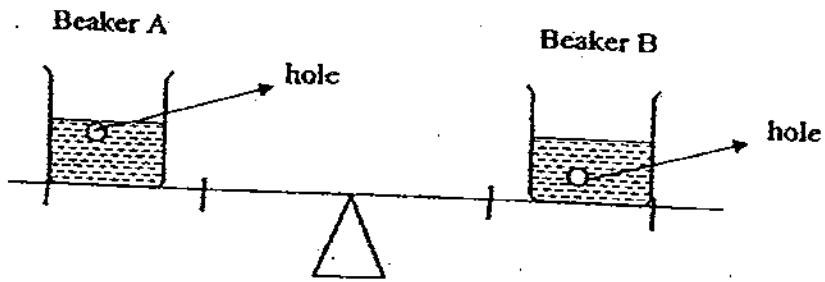

- (a) After some time, it was observed that the beam tilted to one side. Which is the heavier beaker? Explain your answer. [1]

- (b) Study the diagram below.

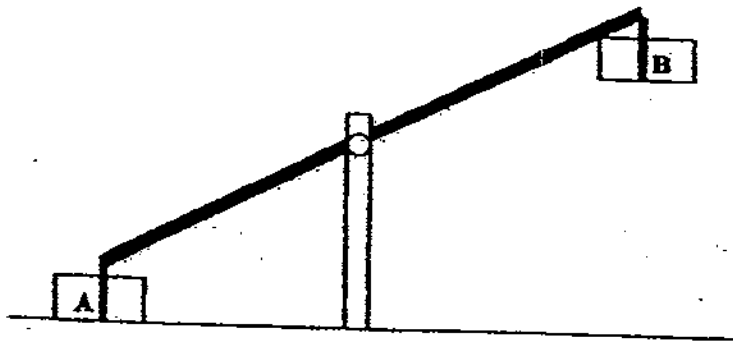

- Without adding or removing anything, what would you do to balance the beam? [1]

43. Sam built a catapult using rubber bands, ice-cream sticks and a plastic spoon as shown in the diagram below.

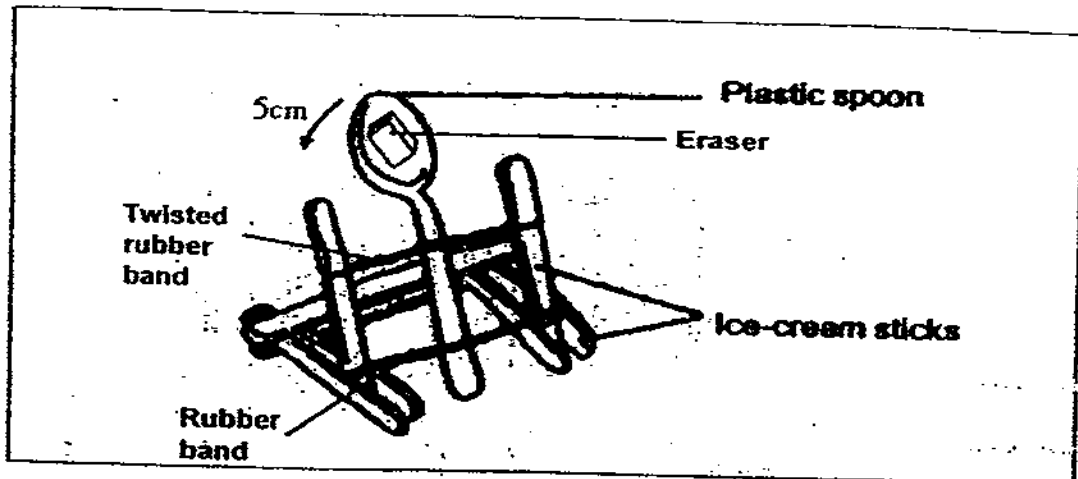

He placed a piece of eraser on the spoon and pushed the spoon 5cm back from its original position indicated by the arrow as shown in the diagram. When he let go of the spoon, the eraser flew forward.

- (a) His friend, Tom, said that one way to shoot the same eraser further without changing the spoon is to push the spoon further back from its original position.

Do you agree with Tom? Give a reason for your answer. [1]

- (b) Suggest another way that Sam can do to the rubber bands so that he can shoot the eraser further without changing the spoon. [1]

44. Man causes most pollution. Deforestation can cause not only air pollution but also water pollution. When trees in a forest are cut down, the soil is blown into the air or washed into the water easily.



- (a) Explain how trees in a forest help to prevent or reduce soil erosion. [1]

- (b) If a lot of loose soil has been washed into a river, what do you think will happen to the aquatic organisms? Explain your answer. [1]

45. Equal amounts of boiling water were poured into two containers, A and B, which were of similar shape and size. The containers were then tightly sealed and left in the field for an hour.

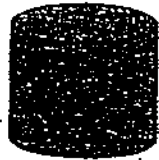

Container A

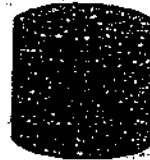

Container B

The table shows the time the water in each container took to cool to room temperature.

Container	Time taken to cool to room temperature (mins)
A	35
B	25

- (a) Suggest why the water in the two containers took different lengths of time to cool to room temperature. [1]

- (b) The experiment was repeated with a copper rod placed only in container A.

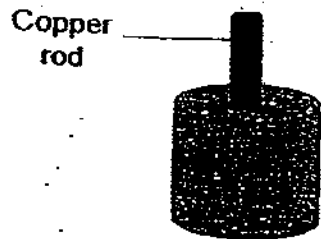

Container A

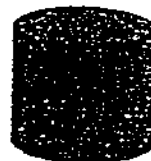

Container B

The table shows the time the water in each container took to cool to room temperature.

Container	Time taken to cool to room temperature (mins)
A	15
B	25

- Explain why there is a difference in the time taken for the water in container A to cool to room temperature. [1]

46. The diagram below shows how a bulb, a piece of wire and a battery are connected to 2 metal plates which are dipped into a liquid in a beaker.

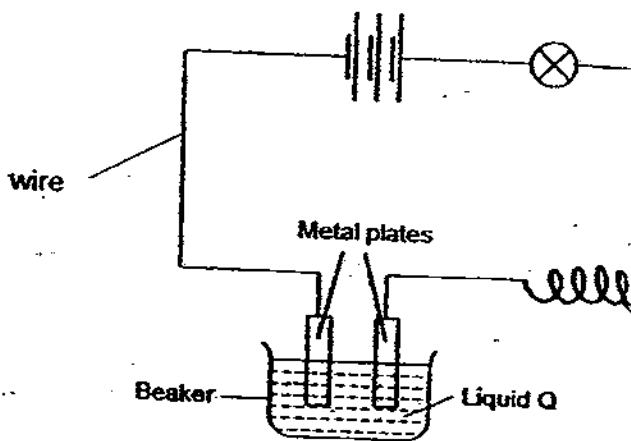

(a) When the switch is closed, the bulb lights up and glows. What does this tell you about liquid Q?

(b) Complete the energy conversions that occur in the circuit that cause the nichrome wire to become hot and glow.

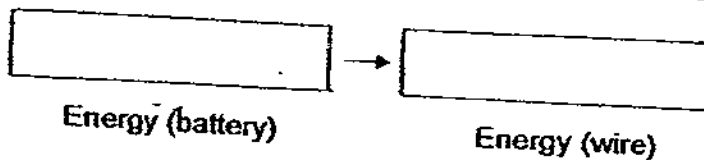

(c) Without removing or adding more bulbs, what could you do to increase the amount of heat produced in the circuit? [1]

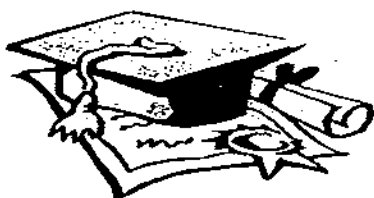

ANSWER SHEET

EXAM PAPER 2009

SCHOOL : MGS PRIMARY
SUBJECT : PRIMARY 6 SCIENCE

TERM : SA2

Q1	Q2	Q3	Q4	Q5	Q6	Q7	Q8	Q9	Q10	Q11	Q12	Q13	Q14	Q15	Q16	Q17
2	1	2	1	2	4	3	3	2	3	4	3	2	2	1	3	4

Q18	Q19	Q20	Q21	Q22	Q23	Q24	Q25	Q26	Q27	Q28	Q29	Q30
3	3	4	4	2	3	4	3	3	3	2	4	1

31) a) Chloroplast. b) leaves.

32) a) Digestive system circulatory system respiratory system.
 b) Glucose.

c) Glucose can be used by the cells during respiration without having to undergo digestion.

33) a) It is to enable blood gases to go to the blood vessels quickly.

b) It is to prevent the blood vessels from bursting due to the force of the blood.

34) a) Set-up B it had decomposed the fastest as it contained the most moisture. The fish produced the most carbon dioxide that reacted with limewater.

b) It confirms that the limewater turns chalky due to the carbon dioxide given off during decomposition and not due to the car.

35) a) D, C, B, A

b) X: Maize plants Y: Snake

c) Use genetic engineering to make the crops rat resistant.

36)a) Structure B. The webbed feet help them to swim and therefore when their country experiences winter, the water turns into ice as a result, they will come to Singapore.

b) It migrates to a warmer place to avoid cold.

c) The oil spill had damaged the feathers of the bird, hence it is unable to fly to Sungei Buloh to escape cold winter.

37)a) i) heat loss ii) heat gain.

b) It is to confirm that the water droplets on the plastic sheet due to the presence of the plants.

38)a) Gas has no definite shape and no definite volume.

b) Gopal would not be able to see if the gas would spread from Jar A to B if he uses a colour less gas.

39)

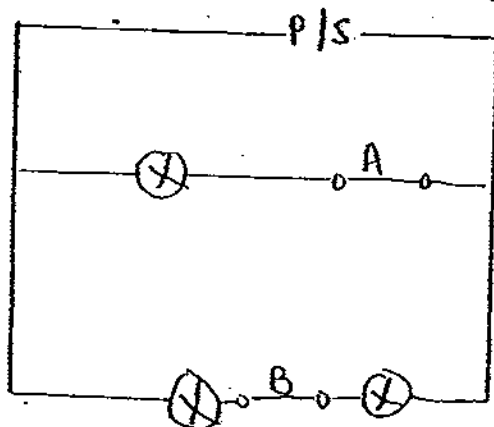

40)a) In set-up A, the length of the copper bar should be the one as the ones in set-up B and C. In set-up B, the batteries should be arranged in series instead of parallel.

b) Repeat the experiment survival times.

41)a) North pole.

b) 1) The magnet might be too weak to attract the iron nail.

2) The container might be a magnetic material and magnetism could not pass through.

42)a) The hole in A is higher than that the hole in beaker B therefore less water is lost in beaker A therefore it has more water than beaker B thus, A is heavier.

b) Move A closer to the center.

43)a)Yes. The rubber bands are stretched further. There will be more potential energy which will be converted to more kinetic energy.

b)Twist the rubber and more.

44)a)The roots of the trees hold the soil together.

b)The soil blocks out light that enters the water for the water plants to photosynthesize. As a result, less oxygen is produced. The aquatic organisms may suffocate and die.

45)a)The containers are made of different materials and container B is a better conductor of heat than A.

b)The copper rod helps the water in container A to cool faster as it is a good conductor of heat therefore it loses heat easily.

46)a)Liquid Q is a good conductor of electricity.

b)Chemical potential \rightarrow Electrical \rightarrow Heat + Light

c)Add more batteries.

