

SA1



RAFFLES GIRLS' PRIMARY SCHOOL

MID-YEAR EXAMINATION
2021

Section A	56
Section B	44
Your score out of 100%	
Parent's signature	

Name : _____

Index No _____

Class: P6

4 May 2021

SCIENCE

Duration: 1 h 45 min

SECTION A (28 x 2 marks)

For each question from 1 to 28, four options are given. One of them is the correct answer. Make your choice (1, 2, 3 or 4). Shade the correct oval (1, 2, 3 or 4) on the Optical Answer Sheet (OAS) provided.

1. Peter placed a piece of bread on a table. After a few days, he noticed that the bread turned mouldy. Which of the following conditions are needed for the bread to turn mouldy?

- A light
- B water
- C oxygen
- D carbon dioxide

- (1) A and C only
- (2) A and D only
- (3) B and C only
- (4) B and D only

2. The characteristics of four plants, P, Q, R and S, were recorded in the table below. A tick (✓) indicates the presence of the characteristics.

Plants	Characteristics of plants		
	Has fruits	Has spores	Lives in water
P	✓		
Q	✓		✓
R		✓	✓
S	✓	✓	✓

Which one of the following plant has its characteristics recorded incorrectly?

- (1) P
 (2) Q
 (3) R
 (4) S
3. Adam conducted a study on animals X, Y and Z. He recorded his observations in the table below. A tick (✓) shows the presence of the observation.

Observation	X	Y	Z
Adult has six legs.		✓	✓
Eggs are laid in water.	✓	✓	
The young looks like the adult.			✓
There are 4 stages in the life cycle.		✓	

Which one of the following represents X, Y and Z?

- | | X | Y | Z |
|-----|-----------|-----------|-----------|
| (1) | cockroach | frog | mosquito |
| (2) | frog | mosquito | cockroach |
| (3) | cockroach | mosquito | frog |
| (4) | frog | cockroach | mosquito |

4. The diagrams below show some seeds placed in four identical containers, W, X, Y and Z.

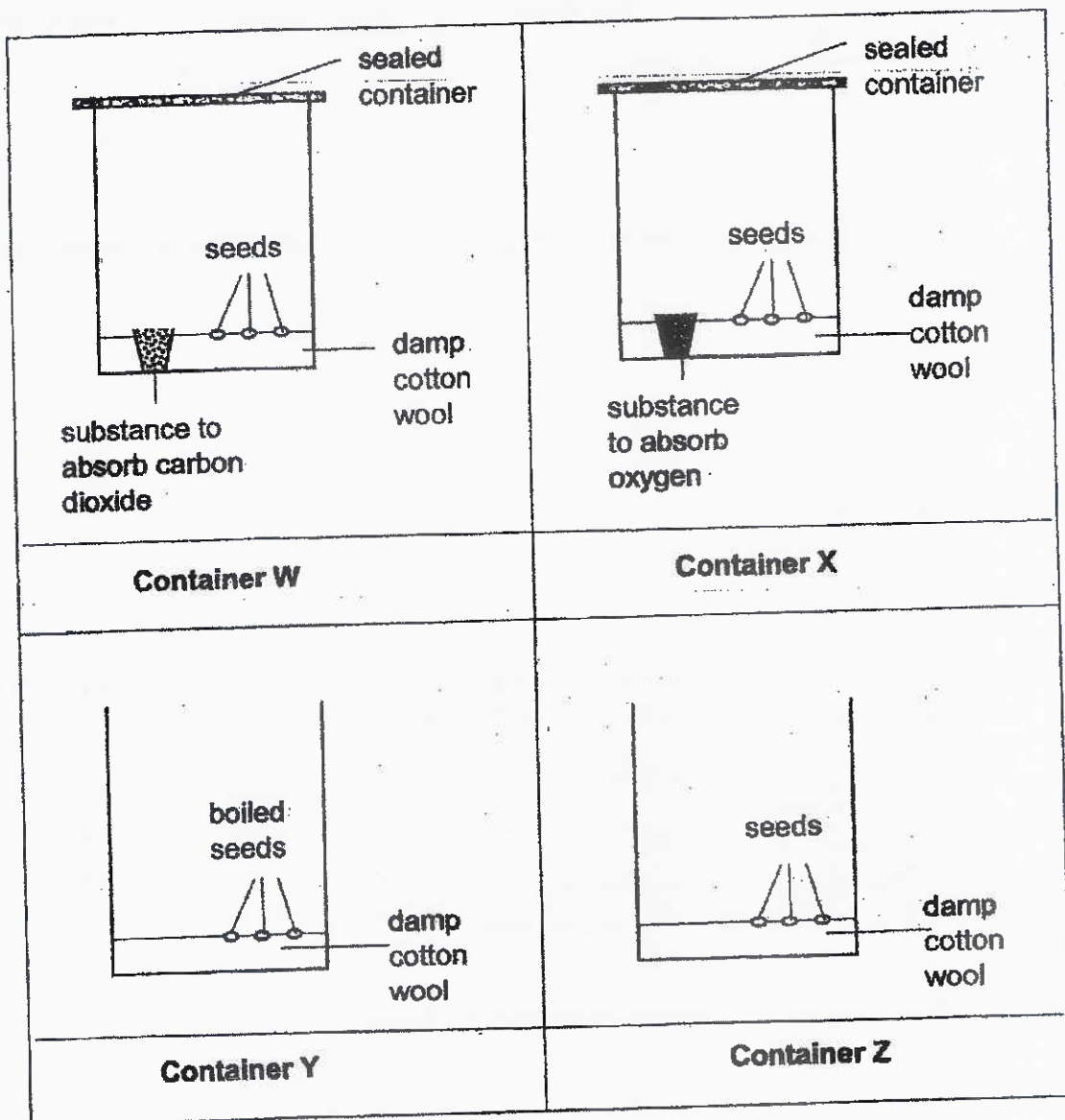

In which of the containers, W, X, Y and Z, would the seeds most likely germinate?

- (1) Y and Z only
- (2) W and Z only
- (3) X and Y only
- (4) W, X and Z only

5. The diagram below shows a female reproductive system.

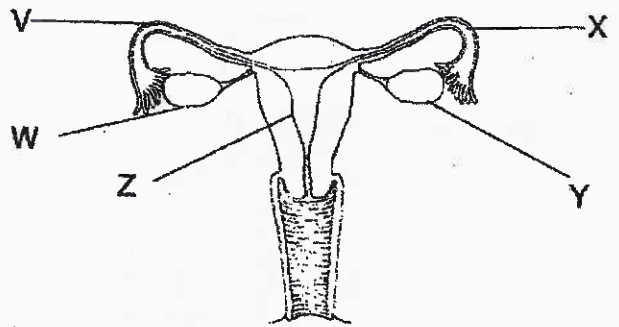

Based on the diagram above, which one of the following statements is correct?

- (1) Fertilisation takes place at Z.
 - (2) The fertilised egg develops in Z.
 - (3) The sperm can only travel along X but not V.
 - (4) When only Y is removed, no eggs can be produced.
6. The diagram below shows a fruit containing two seeds.

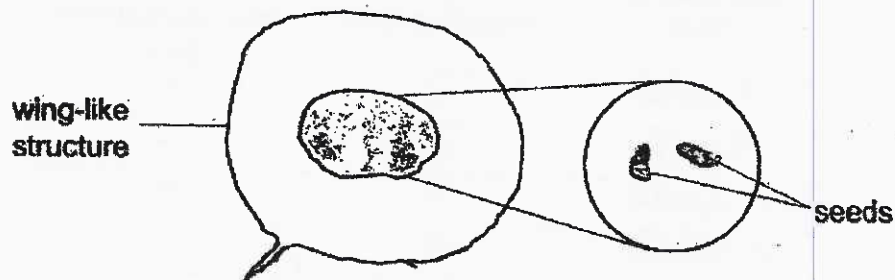

Based on the diagram above, which of the following statements are correct?

- A Pollination and fertilisation had taken place.
 - B There were more than one ovules in the ovary.
 - C The fruit would be dispersed by water as it has small seeds.
 - D The fruit was developed from the anther while the seeds developed from the ovary.
- (1) A and B only
 - (2) A and C only
 - (3) B, C and D only
 - (4) A, B, C and D

7. The diagram below shows the human digestive system.

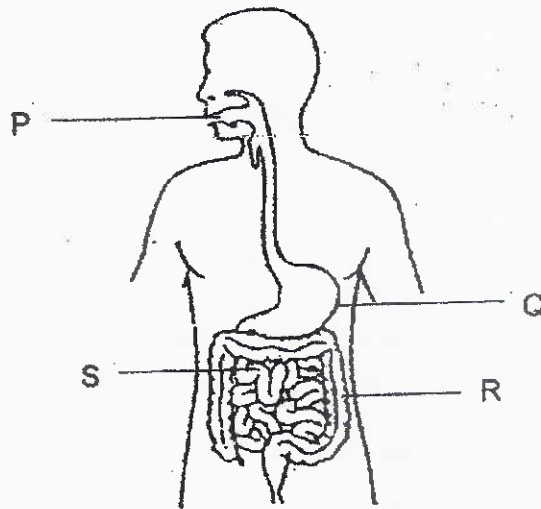

Based on the above diagram, which of the following is correct?

Function of organs		
digestion of food	absorption of digested food	removes water from undigested food
(1) P and Q	Q	R
(2) R and S	R	Q
(3) P, Q and S	S	R
(4) P, Q and R	P	S

8. Farah conducted an experiment to find out if the presence of roots would affect the volume of water taken in by the plant. The diagrams below show four set-ups.

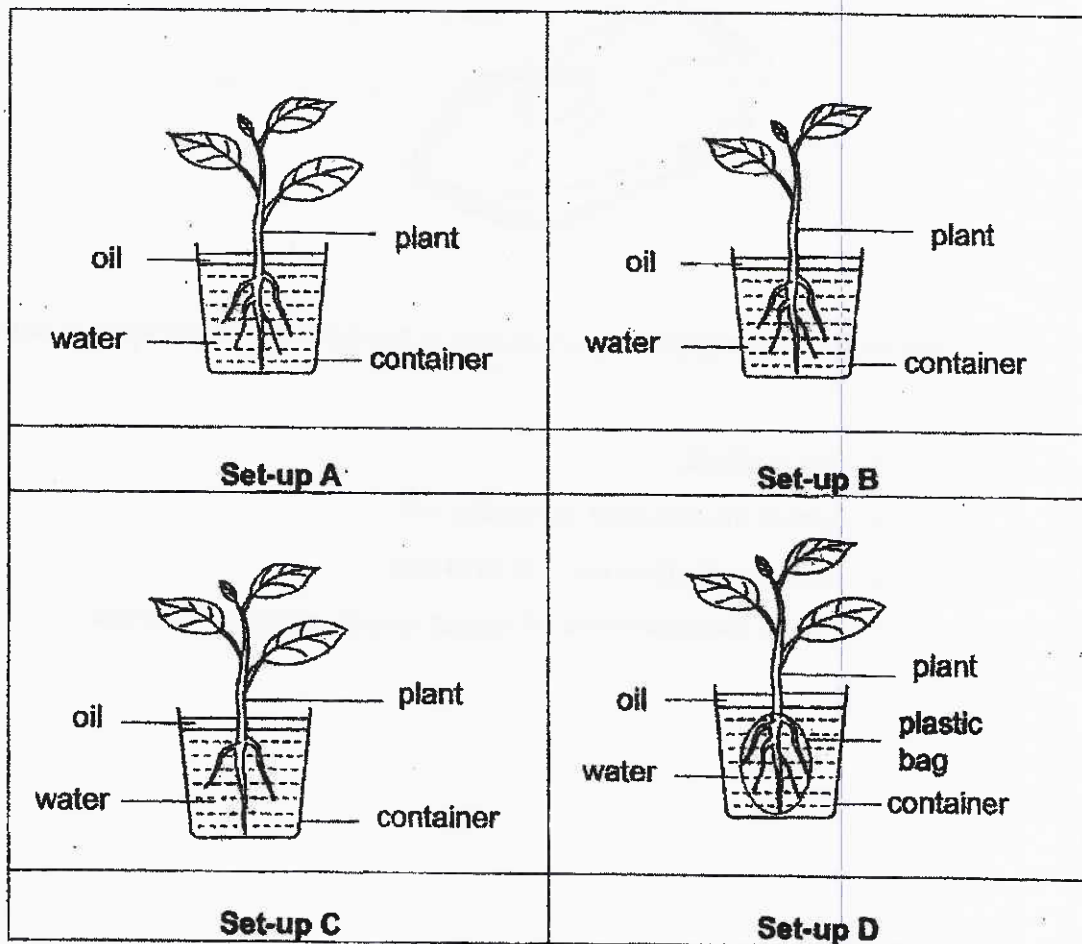

Which of the following set-ups should she use to conduct a fair test?

- (1) A and C only
- (2) A and D only
- (3) B and C only
- (4) B and D only

9. The diagram below shows a cell.

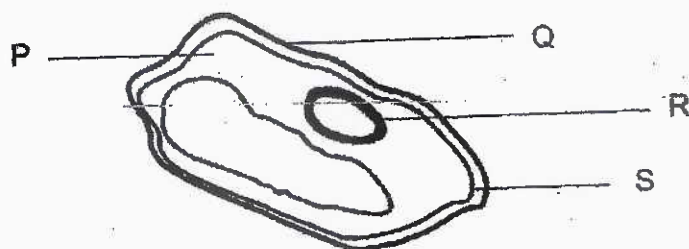

Based on the diagram above, which one of the following statements is correct?

- (1) R traps sunlight.
- (2) S controls the activities within the cell.
- (3) Q protects and gives the cell its shape.
- (4) P controls the movement of substances in and out of the cell.

10. The diagram below shows different parts of a plant namely leaves, roots, X and Y.

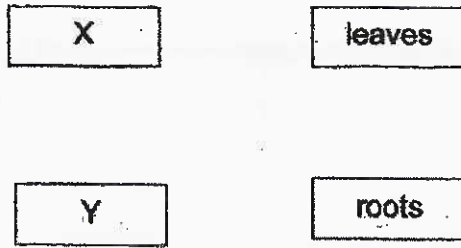

Which one of the following shows how food is transported in a plant as indicated by the arrows?

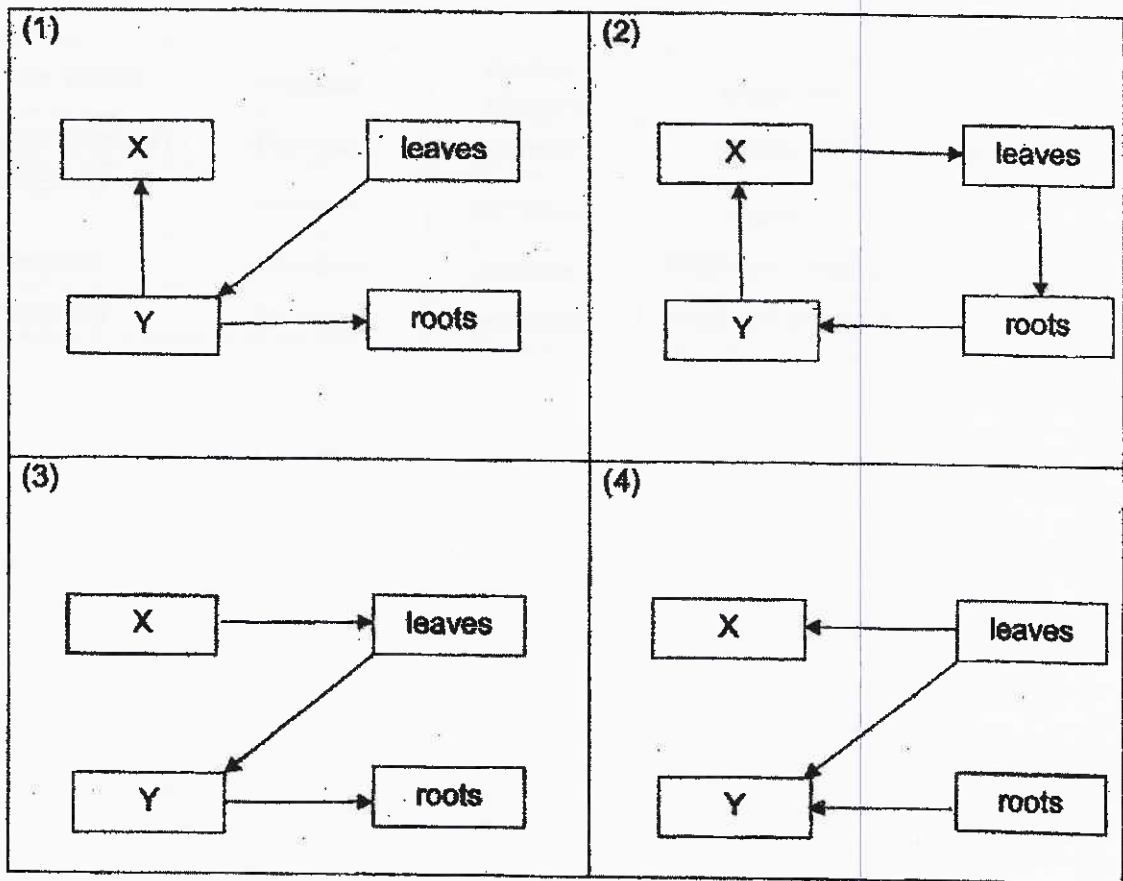

11. Kate placed two tortoises into a sealed container and left it on a table for one hour.

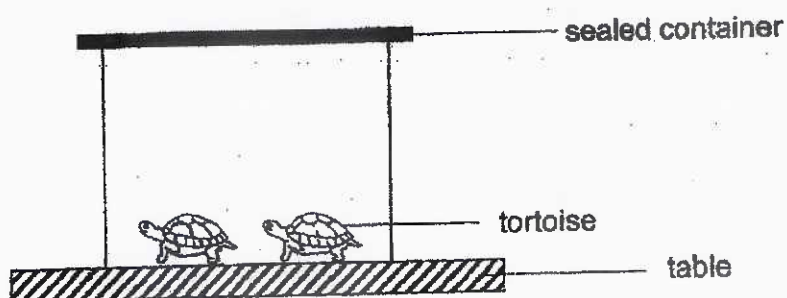

Which one of the following shows the change in the amount of gases after one hour?

	Nitrogen	Carbon dioxide	Oxygen	Water vapour
(1)	decrease	increase	decrease	remains the same
(2)	increase	decrease	increase	Increase
(3)	remains the same	increase	decrease	increase
(4)	remains the same	decrease	increase	decrease

12. The information below describes the environmental conditions of habitats, S and T, throughout the day.

Habitat	Environmental Conditions			
	Amount of light	Temperature	Humidity	Air movement
S	changes	changes	low	changes depending on the presence of wind
T	remains fairly low	fairly constant	high	little air movement at certain part even if there is wind

Based only on the information above, which locations most likely represent habitats, S and T?

	Habitat S	Habitat T
(1)	pond	open field
(2)	rotting log	pond
(3)	open field	leaf litter
(4)	leaf litter	rotting log

13. The graph below shows how the population of organisms Q and R are affected by the temperature of the environment which they live in.

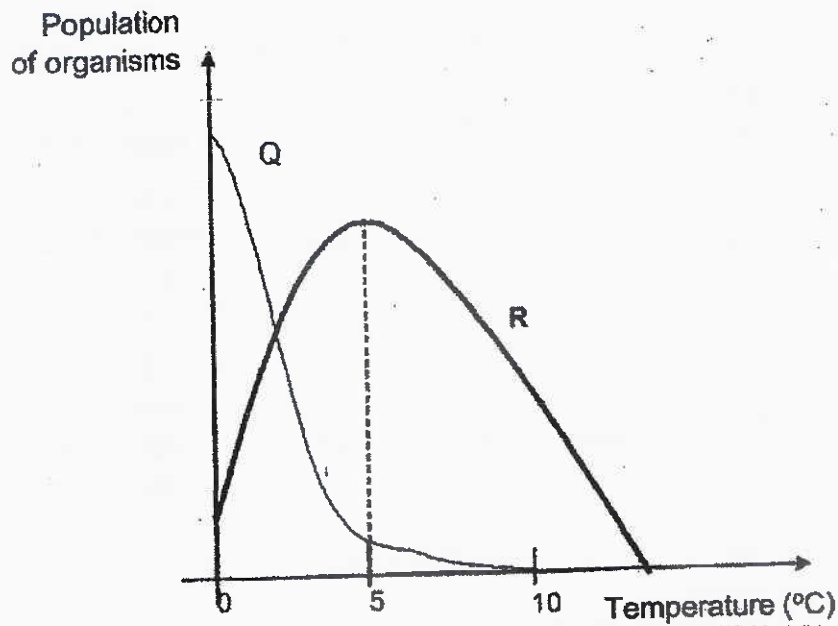

Based on the graphs above, which one of the following is correct?

- (1) Q survives better at a higher temperature than R.
- (2) Population of Q and R increase as temperature increases.
- (3) Population of R increases as temperature increases but not Q.
- (4) Population of Q decreases but population of R increases between 0 °C and 5 °C.

14. Study the food web below carefully.

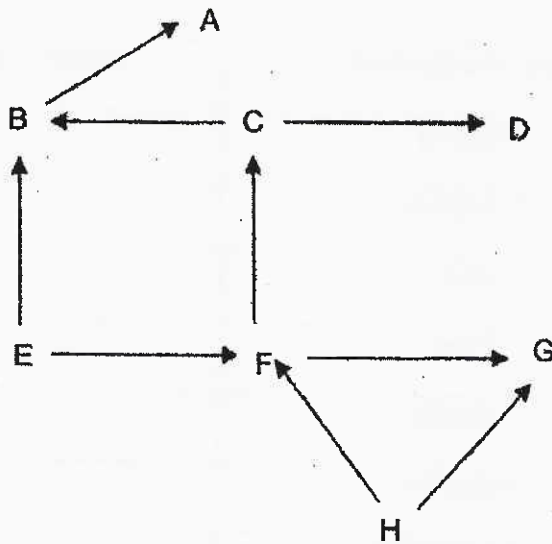

Based on the information above, which of the following statement(s) is/are correct?

- A There is only one herbivore.
 B There is only one food producer.
 C There are at least four predators.
- (1) B only
 (2) A and B only
 (3) A and C only
 (4) B and C only

15. Nicole counted the number of organisms in a garden. She recorded her observations in the table below.

Type of organism	Number of organism
Butterfly	2
Caterpillar	4
Fish	2
Frog	2
Tadpole	5
Water lily	3
Water hyacinth	3

Based on the table above, which of the following statement(s) is/are correct?

- A There are two types of frogs.
B There are five populations of animals.
C There are at least five populations of organisms.
- (1) B only
(2) C only
(3) A and B only
(4) A, B and C

16. An experiment was conducted on a plant that has variegated leaves with different colours on it as shown below.

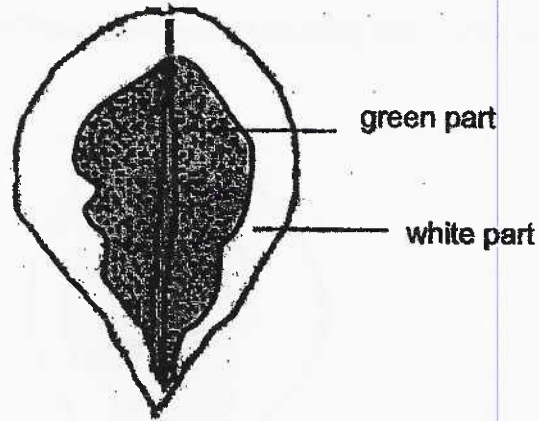

Variegated leaf

Before the experiment was carried out, the plant was kept in the dark for forty-eight hours. A part of a leaf was then covered with black paper and the plant was left in the sun as shown below.

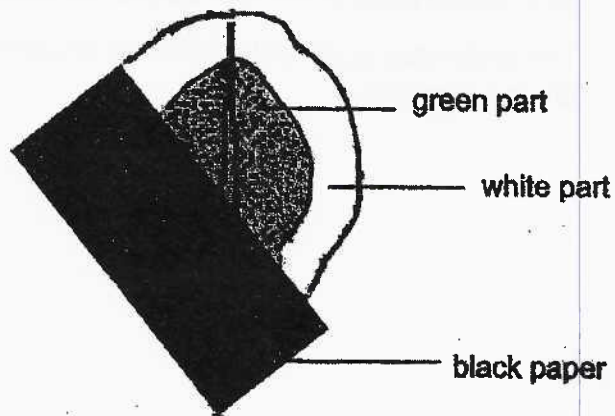

Continue on the next page

Continued from the previous page

After six hours in the sun, the leaf was removed from the plant and tested for starch using iodine solution. The parts of the leaf shaded showed the iodine turned dark blue.

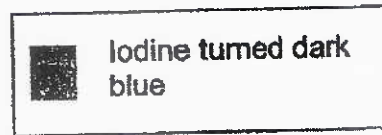
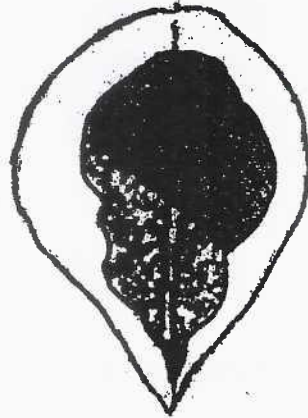

Based on the above observation, which of the following statement(s) is/are true?

- A The white part of the leaf does not contain chlorophyll
- B All exposed parts of the leaf carried out photosynthesis.
- C The green part covered by the black paper was not able to photosynthesise.

- (1) A only
- (2) B only
- (3) A and C only
- (4) A, B and C

17. Mrs Lee wanted to buy a pair of gloves that was easy to wear so that she could push the trolley and to avoid contact with wet surfaces when buying groceries in the supermarket during Covid-19 period.

Which of the following are important properties for the gloves to serve its purpose stated above?

- A flexibility
- B strength
- C waterproof

- (1) A and B only
 - (2) A and C only
 - (3) B and C only
 - (4) A, B and C
18. Ken moulded some plasticine into a hollow cylinder. Then he remoulded the same piece of plasticine into a solid ball as shown in the diagrams below.

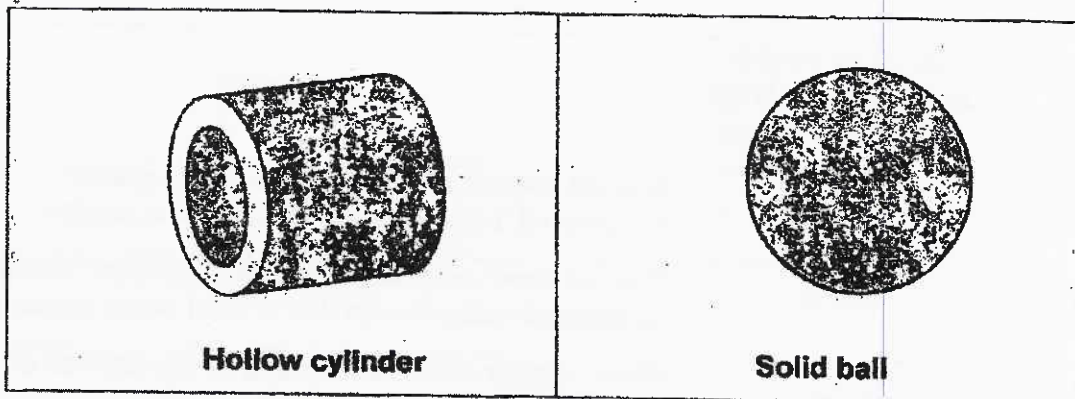

In what ways are the cylinder and ball similar to each other?

Both the cylinder and the ball have the same _____.

- A mass
 - B weight
 - C volume
- (1) A only
 - (2) C only
 - (3) A and B only
 - (4) B and C only

19. Rubin placed a beaker of hot water at $80\text{ }^{\circ}\text{C}$ on an electronic scale in a classroom. She noted the reading on the electronic scale at the start of the experiment as shown in the diagram below.

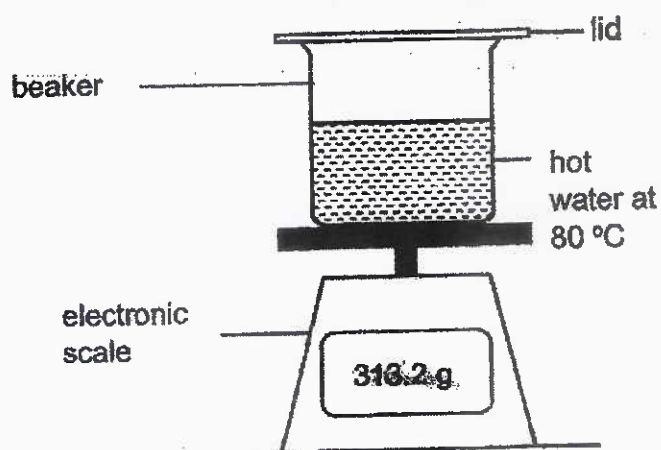

Which one of the following shows the reading on the electronic scale after ten minutes and the correct explanation?

	Reading on the electronic scale (g) after ten minutes	Explanation
(1)	312.2	A small amount of the hot water in the beaker evaporated. Less water remained in the beaker.
(2)	314.0	The hot water evaporated and the hot water vapour condensed within the beaker to form water droplets.
(3)	313.5	Water vapour in the surrounding air condensed on the outer surface of the beaker.
(4)	313.2	The water evaporated and the water vapour that condensed remained within the beaker.

20. Simon set up three different circuits with four different materials, P, Q, R and S, as shown below.

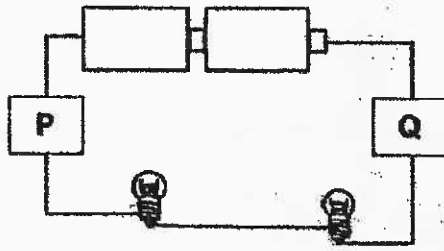

bulbs did not light up

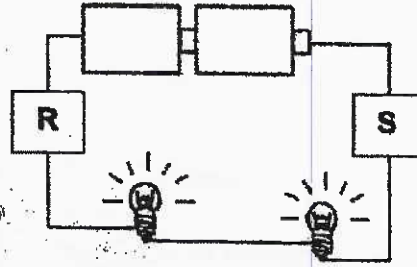

bulbs light up

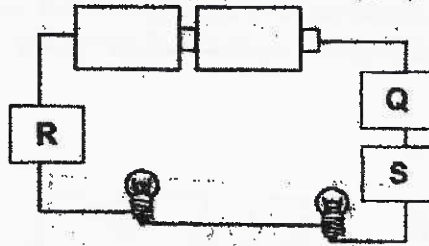

bulbs did not light up

Based on the above information, which of the following statement(s) is/are definitely true?

- A P is a conductor of electricity.
 - B Q is an insulator of electricity.
 - C R is a conductor of electricity.
 - D S is an insulator of electricity.
- (1) C only
- (2) A and C only
- (3) B and C only
- (4) B and D only

21. Kaylea bought a battery operated musical spinning toy as shown below.

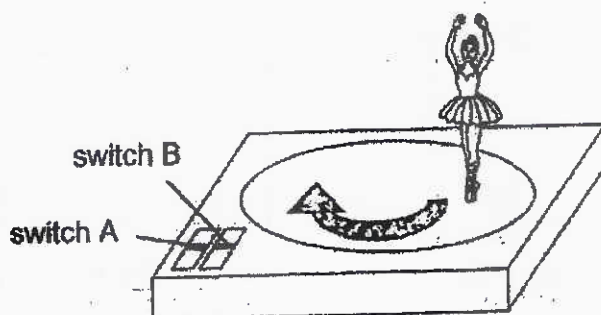

When she turned on the switches, the toy did not work properly. She opened the toy up and found the following electrical circuit in the toy.

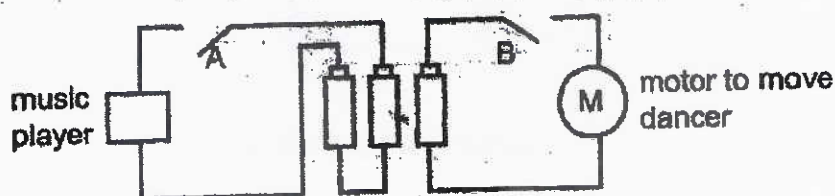

Based on the circuit above, which of the following would Kaylea observe?

	Switch(es) that is / are closed	Observation
(1)	A only	Dancer did not move. There was music.
(2)	B only	Dancer did not move. There was no music.
(3)	Both A and B	Dancer moved in a circle with music.
(4)	Both A and B	Dancer moved in a circle without music.

22. The diagrams below show three set-ups with different pairs of magnets W, X, Y and Z. The magnets have the same mass.

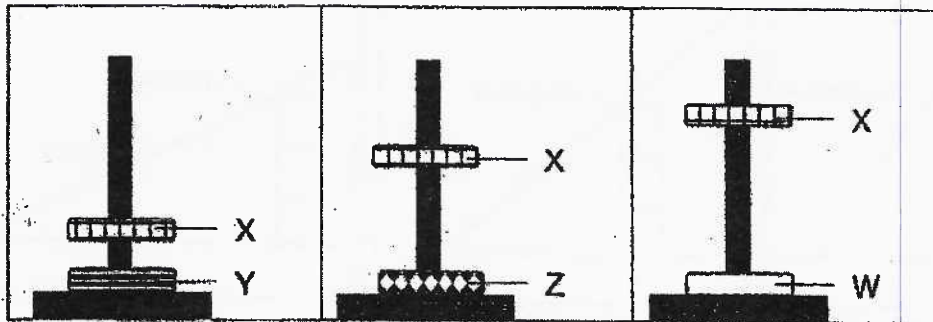

Which of the following statement(s) is/are correct?

- A Magnet W is stronger than Y and Z
- B Magnet Y is stronger than W and Z.
- C Magnet Z is stronger than W but weaker than Y.

- (1) A only
- (2) B only
- (3) B and C only
- (4) A, B and C

23. Samy carried out an investigation with three ramps as shown below.

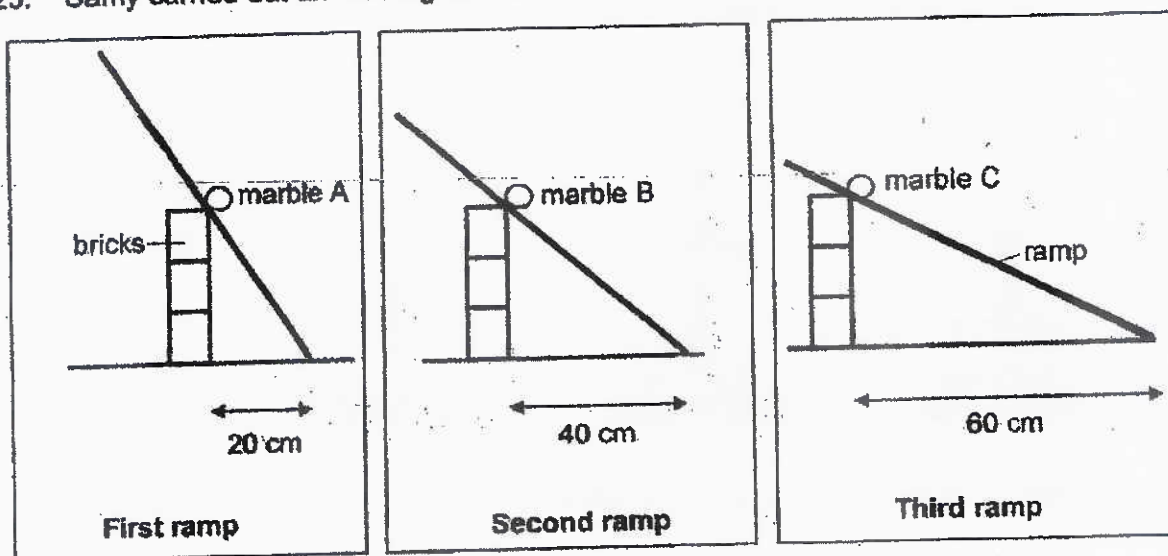

He used identical ramps. The bricks that support the ramps were of the same size and mass for the three set-ups. Marbles A, B and C were of the same size and mass.

Which one of the following statements is true of the marbles when they were placed at the same height above the ground?

- (1) Marble A had the most gravitational force and frictional force acting on it.
- (2) Marble C had the least gravitational force and frictional force acting on it.
- (3) All three marbles had the same amount of gravitational force acting on them. ³
- (4) Only marbles B and C had the same amount of gravitational force acting on them.

24. Mr Tan dragged cart A and cart B over a distance of 20 m along the same surface. He found it harder to drag cart A than cart B.

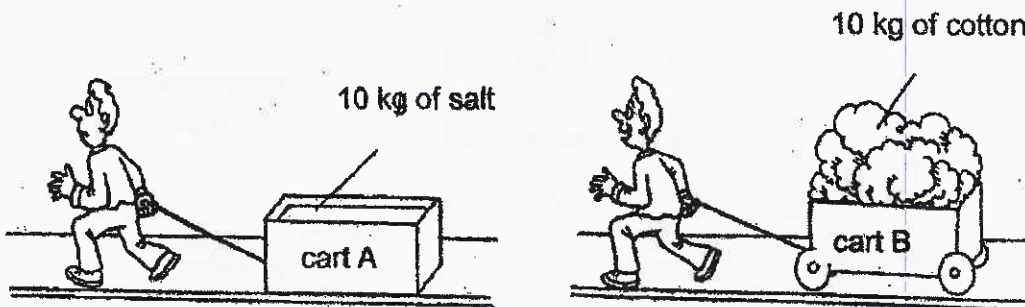

Which of the following statement(s) best explain(s) his observation?

- A The salt was heavier.
 - B There was no friction between the cart B and the floor surface.
 - C There was more friction between the cart A and the floor surface.
- (1) C only
- (2) A and B only
- (3) A and C only
- (4) A, B and C

25. The diagram below shows a glass lid, with a hole, which is used to cover a wooden container.

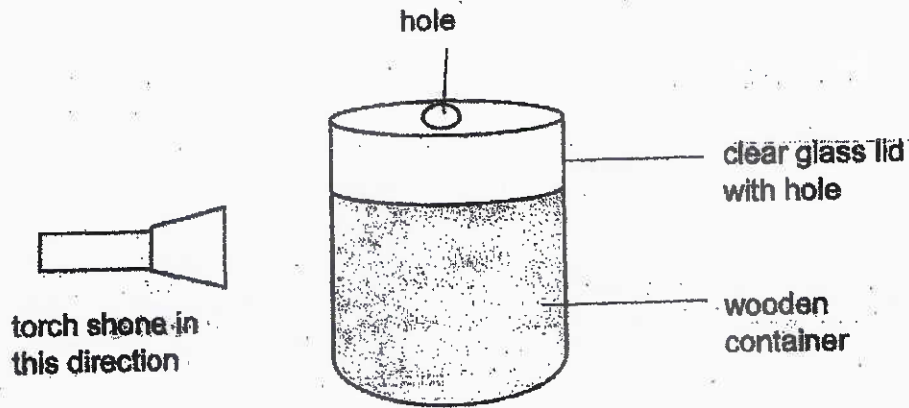

Which of the following is a possible shadow cast by the object when a torch shone on it in the direction as shown above?

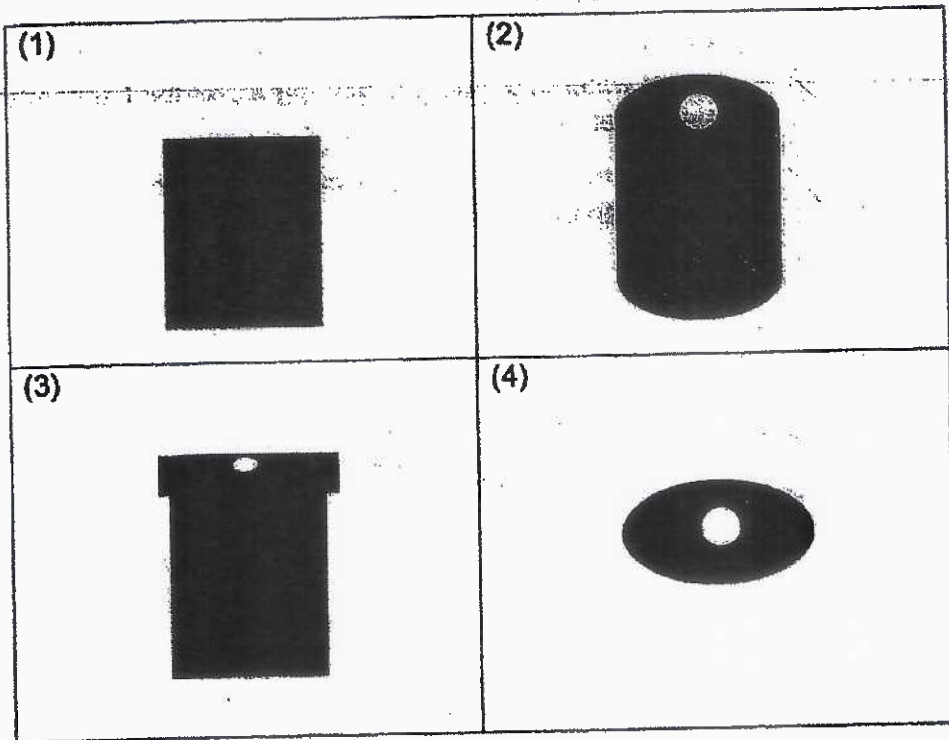

26. John prepared two similar set-ups as shown below.

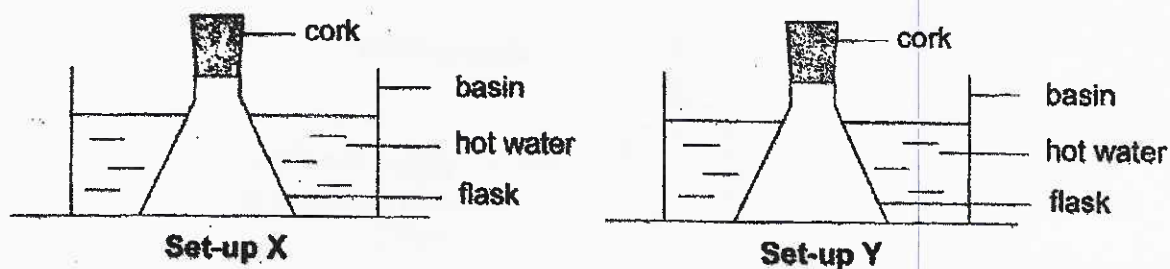

The cork in the set-up X shot out of the flask after some time.

Which of the following statement(s) is/are correct?

- A The flask lost heat to the hot water in set-up X more quickly than that in set-up Y.
- B The hot water in set-up X is at a higher temperature than the hot water in set-up Y.
- C The air in the flask in set-up X gains heat from the hot water more quickly than that in set-up Y.

- (1) A only
- (2) C only
- (3) A and B only
- (4) B and C only

27. Julia wanted to find out if the presence of container M helps to keep water hot for a longer time. She placed a paper cup filled with hot water into container M as shown below.

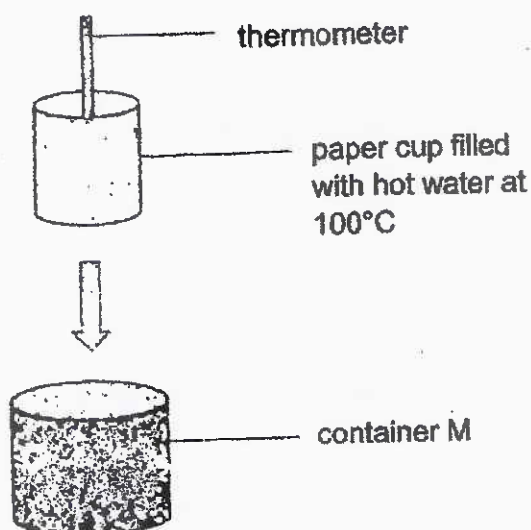

Her teacher told her to include a control set-up in her experiment. Which of the following should Julia include in the control set-up?

- A thermometer
 - B paper cup filled with tap water
 - C paper cup filled with hot water at 100°C
 - D container similar to container M but made of a different material
- (1) A and B only
(2) A and C only
(3) B and D only
(4) C and D only

28. Jason drives a crane as shown below. An iron ball is attached to his crane. The iron ball would swing into the old buildings to knock them down.

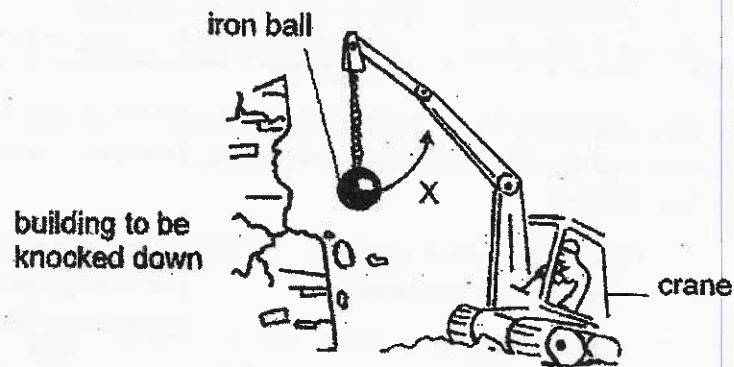

What does Jason have to do if he wants to knock down the building more quickly?

- A Use an iron ball with a smaller mass
- B Use an iron ball with a greater mass
- C Decrease the distance indicated by X
- D Increase the distance indicated by X

- (1) A and C only
- (2) A and D only
- (3) B and C only
- (4) B and D only

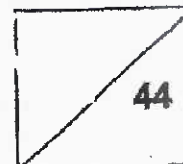

Name: _____ Index No: _____ Class: P6

SECTION B (44 marks)

For questions 29 to 41, write your answers clearly in the spaces provided.

The number of marks is shown in brackets [] at the end of each question or part question.

29. Helen conducted an experiment by recording her pulse rate when she was at rest and immediately after she had exercised for twenty minutes. The table below shows her pulse rate for her first attempt.

Attempt	Pulse rate when at rest (beats per minute)	Pulse rate after exercising for twenty minutes (beats per minute)
1 st	80	100

- (a) Why did Helen's pulse rate increase after she has exercised for twenty minutes? [1]

After her first attempt, she decided to repeat her experiment. Between each attempt, she rested for five minutes. The table below shows her pulse rate for the second and third attempt.

Attempts	Pulse rate between attempts after resting for five minutes (beats per minute)	Pulse rate immediately after exercising for twenty minutes (beats per minute)
2 nd	98	110
3 rd	105	110

- (b) Her friend, Rebecca, commented that her pulse rates between attempts were incorrect. Explain why Rebecca said so and what Helen should have done differently in order to conduct a fair test. [2]

Score	3
-------	---

30. Paul wanted to find out if temperature and light have an effect on the germination of spores of Fern A. He prepared set-ups 1 and 2, as shown in the diagrams below. Both set-ups contained the same number of spores. He placed both set-ups in a brightly lit room.

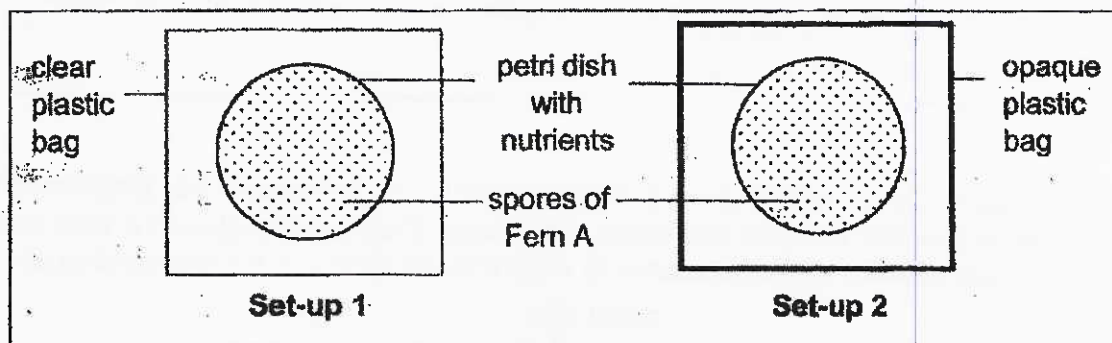

He placed the set-ups in rooms with different temperatures namely 15 °C, 20 °C, 25 °C, 30 °C and 35 °C. He recorded his results in the graph below.

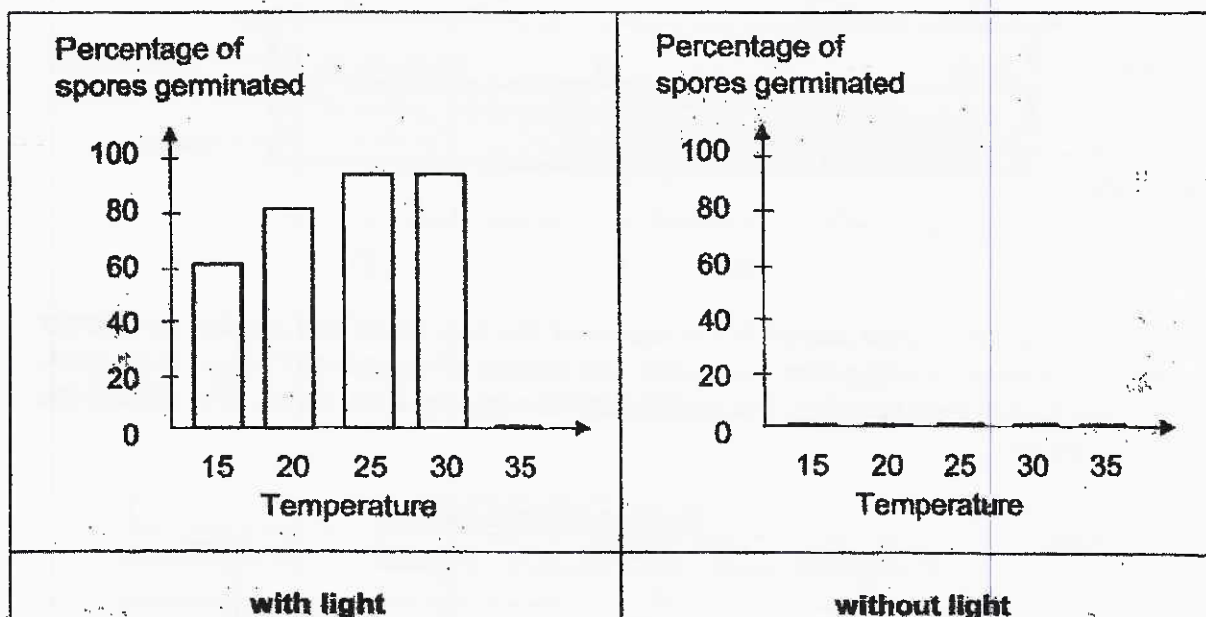

Based on the results above, answer the following questions.

- (a) Based on the information for the condition with light, what is the relationship between temperature and the percentage of spores germinated? [2]

Continue on the next page

Score	2
-------	---

Continued from previous page

- (b) Identify the conditions most suitable for the spores of Fern A to germinate. [1]

31. The diagram below shows an experimental set-up to investigate the responses of organisms Z to four different conditions. Organisms Z were supported on a wire mesh above a tray of water and a substance to absorb water vapour in the surrounding air.

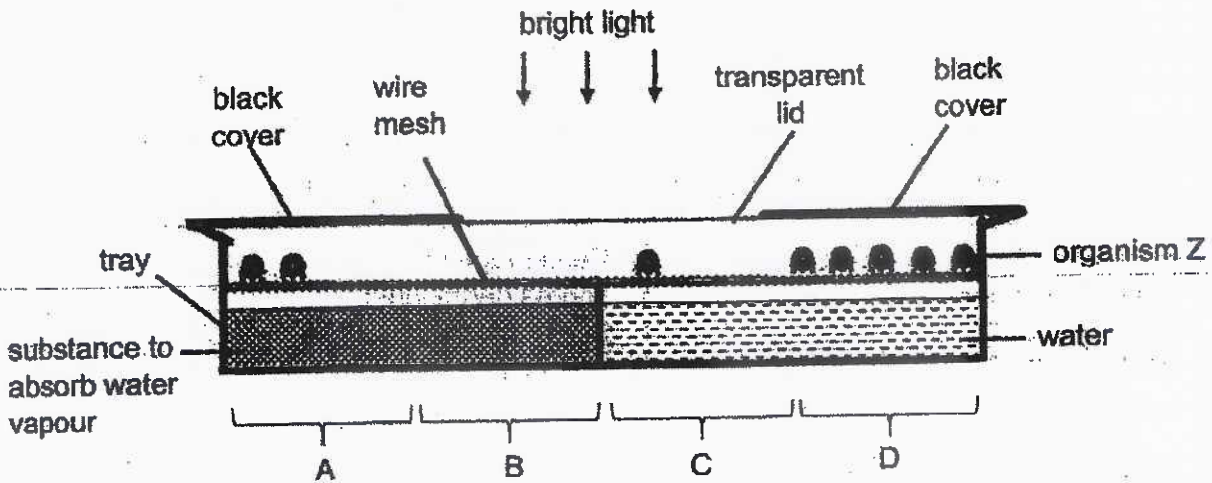

Thirty organisms Z were placed in the centre of the wire mesh and allowed to interact with the exposed conditions for two hours. The number of organisms Z found in areas A, B, C and D was then counted. The experiment was repeated two times. The results are shown below.

Area	Number of organisms			Average
	1 st attempt	2 nd attempt	3 rd attempt	
A	3	2	2	2
B	0	0	1	1
C	5	6	5	5
D	22	22	22	22

- (a) Describe the physical conditions in which the fewest organisms Z were found. [1]

Continue on next page

Score	2
-------	---

Continued from previous page

- (b) Give a reason why organisms Z were left in the set-up for two hours before being counted. [1]

- (c) Suggest a most likely natural habitat for organism Z. Give a reason. [2]

32. Helen wanted to investigate the relationships among animals A, B and C. She placed animals A and B into set-up P and animals A and C into set-up Q. Equal amounts of water plants, X, were added in each set-up. Only one of the animals, A, B or C, was a plant-eater.

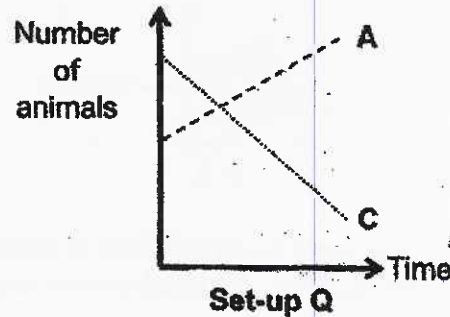
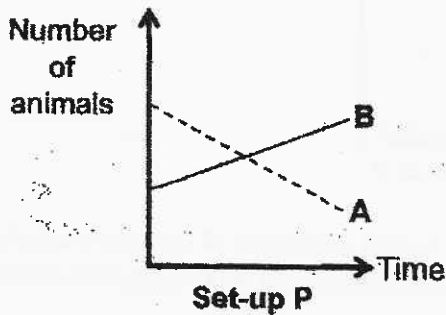

The graphs above show the change in the number of animals over three weeks.

- (a) Based on the graphs above, write down the food chain that shows the relationship among the organisms. [1]

- (b) Based on the information above, which animal(s), A, B or C, is/are both a prey and predator only? [1]

Continue on next page

Score	5
-------	---

Continued from previous page

- (c) Describe the change in population C when there is a greater amount of light. Explain your answer. [2]

33. Weikang wanted to find out if carbon dioxide was taken in by hydrilla during photosynthesis. He set up an experiment as shown in the diagram below.

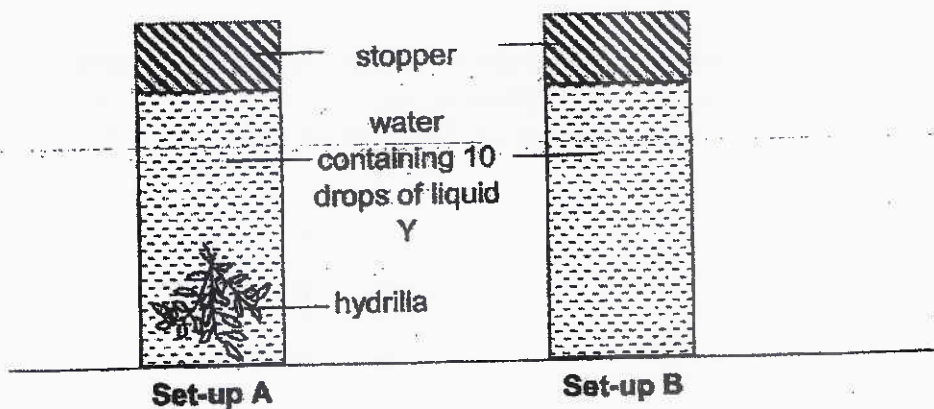

Liquid Y is used as an indicator of carbon dioxide. In the presence of carbon dioxide, the indicator is yellow. It turns from red to purple in the absence of carbon dioxide as shown below.

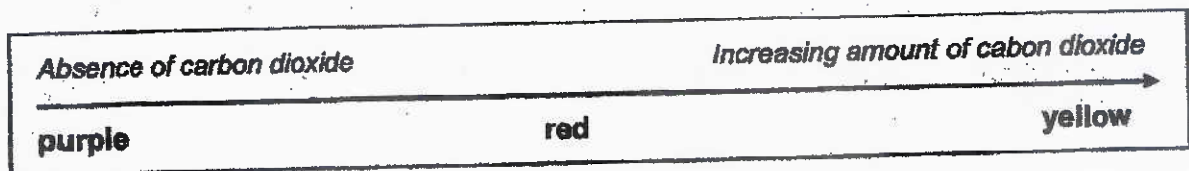

The indicator was red in both set-ups A and B at the start of the experiment.

- (a) Explain why the two set-ups were exposed to bright light throughout the duration of the experiment. [1]

Continue on next page

Score	3
-------	---

Continued from previous page

- (b) State the colour of liquid Y in the two set-ups after six hours below. [1]

Set-up A: _____

Set-up B: _____

- (c) What is the purpose of set-up B? [1]

- (d) Explain why the colour of liquid Y in set-up A was yellow after twelve hours without light. [1]

Score	
-------	---------------------------------------------------------------------------------------

34. Kar Meng wanted to find out if the presence of substance K would affect the rate at which ice melts. He used the set-ups below for his experiment. He then measured the volume of water collected in each measuring cylinder at one-minute intervals for twenty minutes.

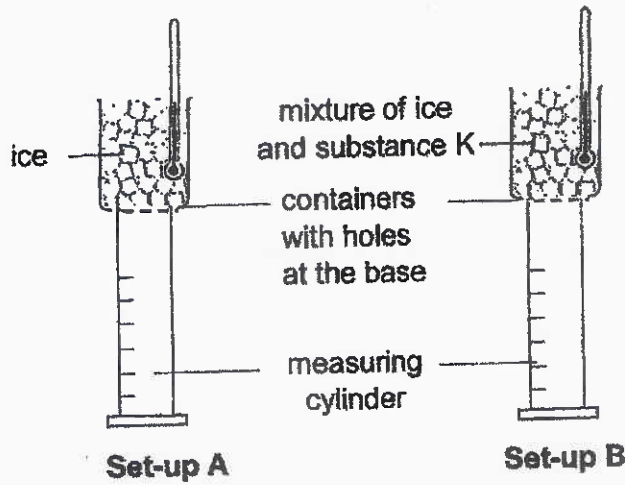

The graph below shows Kar Meng's results.

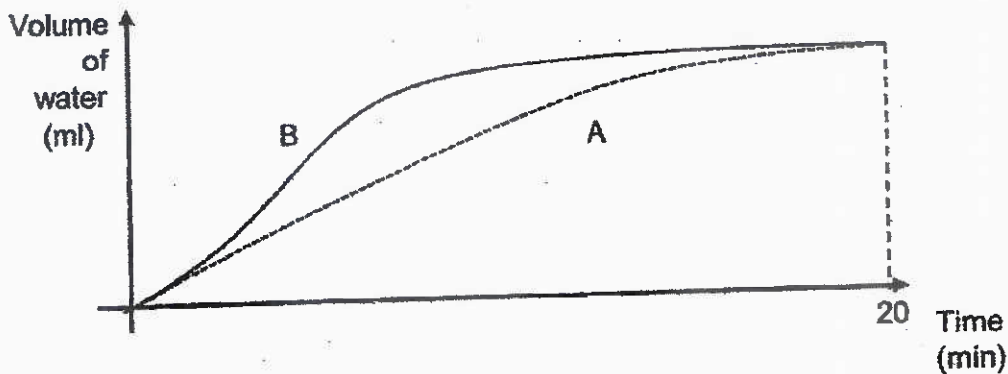

- (a) Based on the graph, what effect did substance K have on the rate at which ice melts? [1]

Score	1
-------	---

Continue on the next page

Continued from previous page

- (b) Explain why the volume of water in both measuring cylinders stopped increasing after twenty minutes. [1]

- (c) Kar Meng carried out the experiment in a room with a constant temperature of 25 °C, explain how this would ensure a fair test. [1]

Kar Meng removed the measuring cylinder from set-up A and placed it on a table in a room with a constant temperature at 25 °C as shown below.

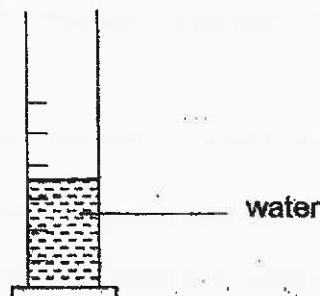

- (d) The water level in the measuring cylinder only decreased slightly after six hours. Without removing the measuring cylinder from the table, suggest how Kar Meng can increase the rate of evaporation of the water. [1]

Score	3
-------	---

35. John wanted to find out how the number of identical bulbs connected in a circuit would affect the brightness of each bulb. He used a light sensor to measure the amount of light given out by each of the bulbs. His first electrical circuit is shown below.

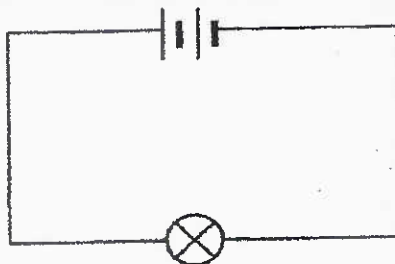

He set up two other electrical circuits using two and three bulbs respectively and the results of his experiment are shown in the table below.

Number of bulbs	Average brightness of each bulb (lux)
1	700
2	700
3	700

- (a) State two variables John must keep constant in his experiment to ensure a fair test. [1]
- (i) _____
- (ii) _____
- (b) Based on John's results, draw a circuit diagram to show how he had arranged the bulbs in his circuit, using three bulbs and two batteries. [2]

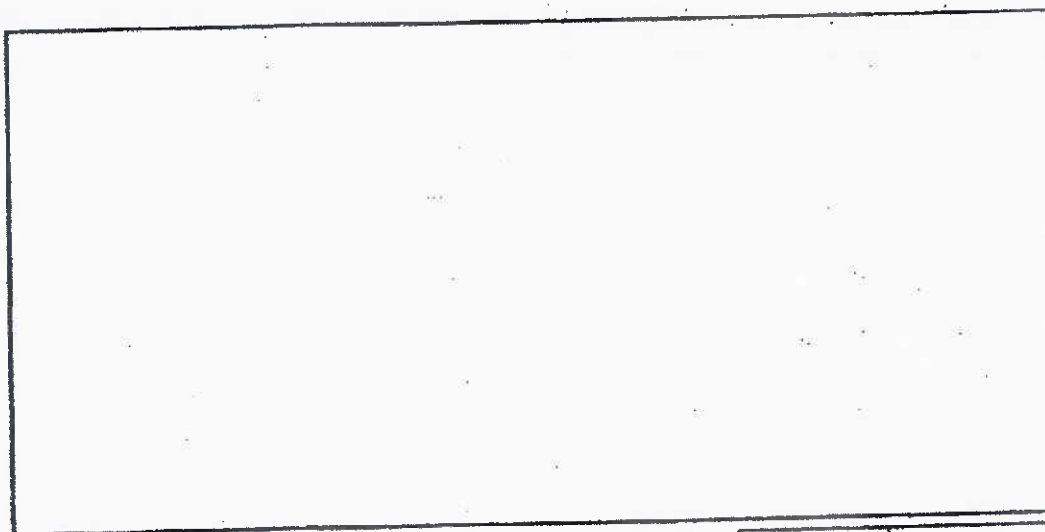

Score	3
-------	---

36. The diagram below shows a set-up with two circuits using two switches namely, S1 and S2. It also contains a moveable iron arm which can swing about the fixed point X as indicated by the arrows.

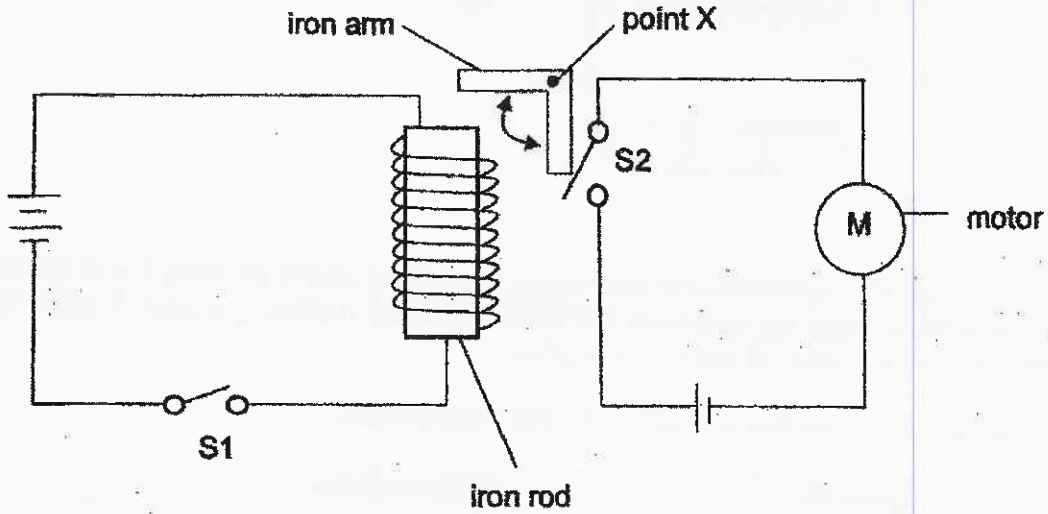

- (a) When S1 is closed, the motor will spin. Describe how this happens. [2]

- (b) If the iron arm is wrapped with an aluminium foil, would the set-up above still work? Give a reason for your answer. [1]

Score	3
-------	---

2021 P6 Science MYE

37. Timothy set up the following circuit as shown below.

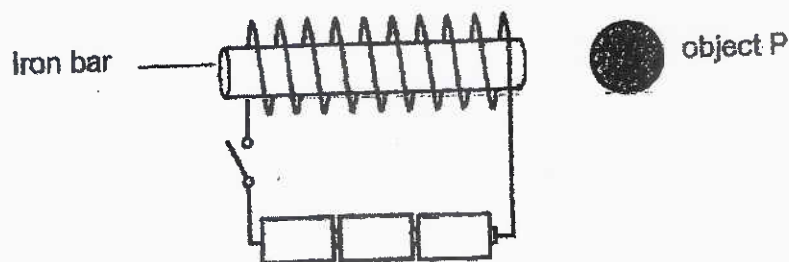

He placed object P near to the iron bar shown above. He closed the switch and recorded his observation. Then he repeated the experiment by replacing object P with Q, of identical shape and size, at the same position.

The table below shows the results of Timothy's experiment.

Objects	Observation
P	moved towards the iron bar
Q	did not move at all

(a) Explain Timothy's observations as shown in the above table. [2]

(b) State two variables that must be kept constant in the experiment to ensure a fair test. [1]

Score	3
-------	---

38. Cindy was cycling at a speed of 30 km/h on a dry road. She applied the brakes on her bicycle when she spotted a stationary car in front. The bicycle only came to a complete stop after travelling a short distance. This distance is called the "braking distance".

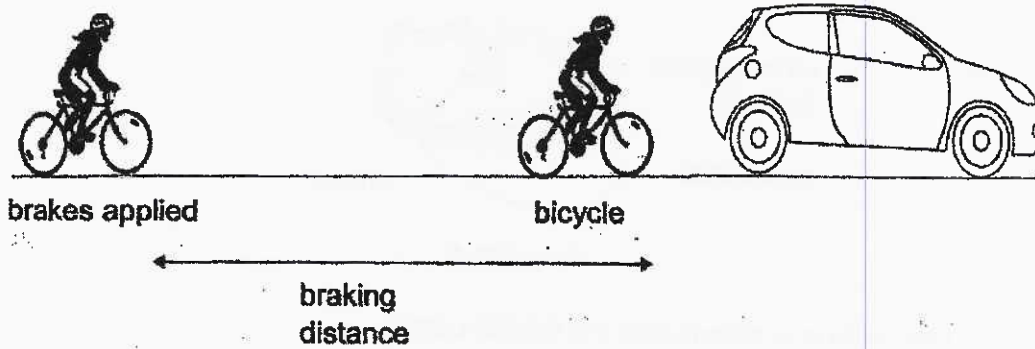

- (a) Name two forces acting on Cindy when she was cycling. [1]

- (b) What would happen to the braking distance if Cindy was cycling on the same bicycle at the same speed on a rainy day? Explain your answer. [2]

Score	3
-------	---

39. Wilson lighted a candle in a paper lantern as shown in Diagram 1 below.

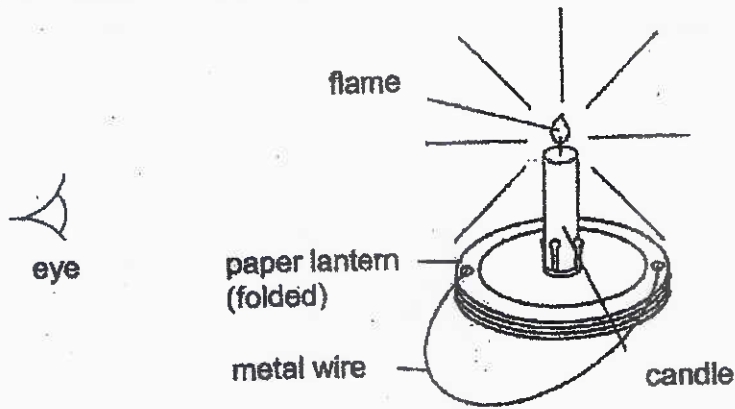

Diagram 1

(a) Explain how Wilson is able to see the lighted candle. [2]

He unfolded the paper lantern by pulling it upwards as shown in the diagram 2 below.

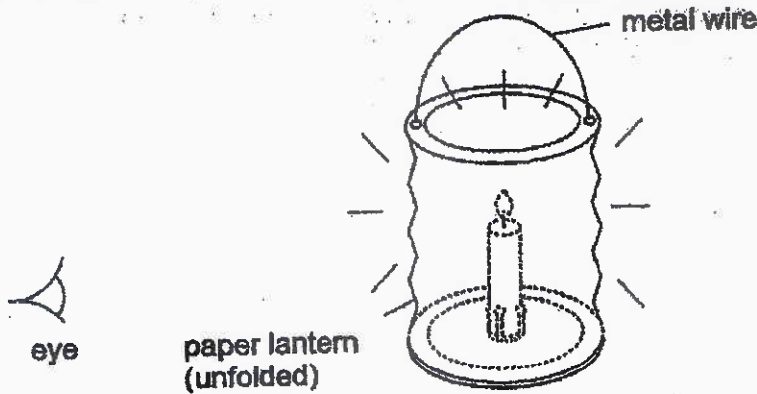
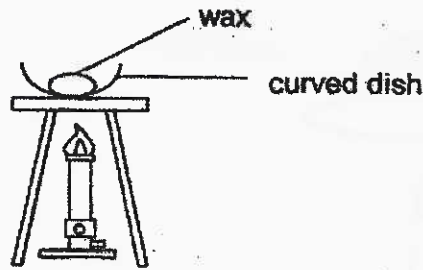

Diagram 2

(b) State a reason why the flame in diagram 2 looked less bright to Wilson than in diagram 1. [1]

Score	3
-------	---

40. Sonia heated four pieces of wax of the same mass in curved dishes P, Q, R and S. The four dishes are made of different materials but of the same thickness.



Sonia removed any unmelted wax and weighed them. The graph below shows the mass of the unmelted wax in the different dishes used.

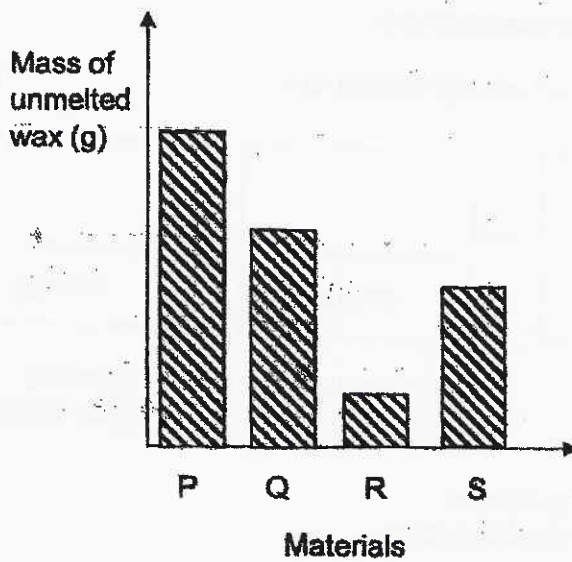

- (a) Based on the above results, what can Sonia conclude about the four materials of the dishes? [1]

- (b) Which material, P, Q, R or S, should Sonia use to make into a box to keep drinks cold for the longest time? Explain your answer. [2]

Score	3
-------	---

41. William prepared a set-up as shown below.

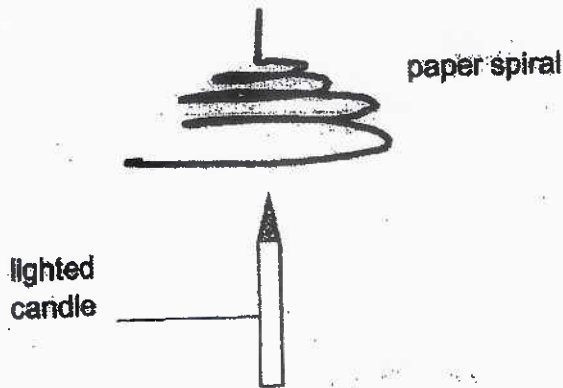

William observed that the paper spiral was spinning.

(a) Fill in the boxes below to show the main energy conversion. [2]

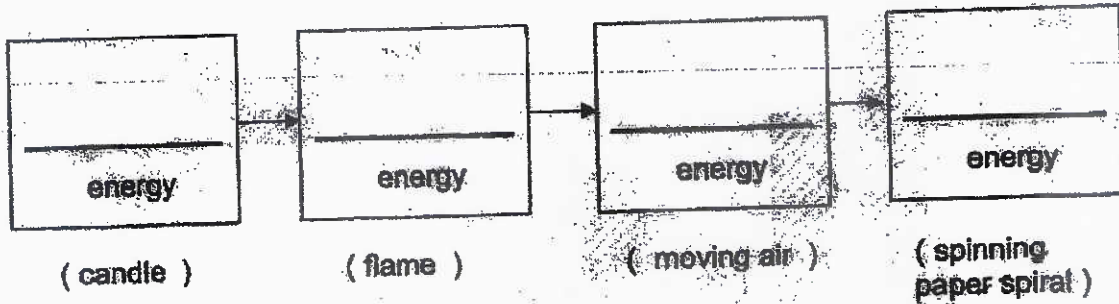

(b) William added another candle in the container. Describe and explain the change in his observation. [2]

END OF PAPER

Score	4
-------	---

2021 P6 Science MYE

ANSWER KEY

YEAR : 2021
LEVEL : PRIMARY 6
SCHOOL : RGPS
SUBJECT : SCIENCE
TERM : MID-YEAR EXAM

SECTION A

Q1	3	Q2	4	Q3	2	Q4	2	Q5	2
Q6	1	Q7	3	Q8	2	Q9	3	Q10	1
Q11	3	Q12	3	Q13	4	Q14	3	Q15	2
Q16	3	Q17	2	Q18	3	Q19	4	Q20	3
Q21	4	Q22	1	Q23	3	Q24	1	Q25	1
Q26	4	Q27	2	Q28	4				

SECTION B

Q29	<p>a) Her heat pumped blood containing oxygen, digested food and water faster to all parts of her body for the cells to release more energy for respiration so that she can exercise.</p> <p>b) Helen's pulse rate was higher than the pulse rate when she was fully at rest. She should have rested for a longer time.</p>
Q30	<p>a) As the temperature increased from 15°C to 30°C for the condition with light, the percentage of spores germinated increased. As the temperature increased from 30°C to 35°C for the condition with light, the percentage of spores germinated decreased.</p> <p>b) Surrounding temperature from 25°C to 30°C with light.</p>
Q31	<p>a) No water with bright light.</p> <p>b) Z is a living thing. The two hours is for Z to respond to the changes in its surrounding for more accurate results. To interact and respond to the changes in the environment.</p> <p>c) Mangrove tree habitat. It is dark and damp which are the most favourable conditions for Z to live in.</p>
Q32	<p>a) $X \rightarrow C \rightarrow A \rightarrow B$</p> <p>b) A</p>

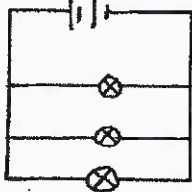
	<p>c) C will increase. X will receive more light, photosynthesize more and grow more. C feeds on X. There will be more X for C to feed on, so the population of C will increase.</p>
Q33	<p>a) Light is needed for the hydrilla to carry out photosynthesis. b) Set up A: Purple Set up B: Red c) B is the control set up. It is to compare and confirm that the absence of carbon dioxide is due to the hydrilla carrying out photosynthesis. d) The hydrilla did not receive light and could not photosynthesize, thus it took in oxygen and gave out carbon dioxide for respiration, so Y is yellow in the increased amount of carbon dioxide.</p>
Q34	<p>a) K increases the rate at which ice melts. b) All the ice had gained heat from the surroundings and melted and dripped into the measuring cylinder. c) This ensures that the rate at which the ice gains heat and melts is due to the presence of K and not the temperature of the surroundings. d) Put a fan blowing at the measuring cylinder.</p>
Q35	<p>a) i) number of batteries ii) voltage of batteries b)</p> 
Q36	<p>a) When S1 is closed, it is a closed circuit and electricity can flow through. The iron rod will be electro-magnetised and attract the iron arm. The iron arm will close S2 and it is a closed circuit so electricity can flow through. Thus, the motor will spin. b) Yes. Can pass through aluminium foil which is a non-magnetic material.</p>
Q37	<p>a) When he closed the switch, it is a closed circuit and electricity can flow through. The iron bar will be electro-magnetised and attract P as it is made of a magnetic material, but the electro-magnet will not attract Q as Q is made of a non-magnetic</p>

	<p>material. Thus, P will move towards the iron bar while Q will not.</p> <p>b) Material of the bar. The arrangement of the batteries.</p>
Q38	<p>a) Gravitational force and air resistance</p> <p>b) The braking distance will increase on a rainy day. The rainwater acts as a lubricant and decreases the amount of friction between the wheels of the bicycle and the road.</p>
Q39	<p>a) The lighted candle gives off light from the lighted candle enters Wilson's eyes.</p> <p>b) The paper lantern only allows some light given off by the lighted candle to pass through it and less light enters into his eyes. Thus, the flame looks less bright.</p>
Q40	<p>a) R is the best conductor of heat followed by S, Q, and P.</p> <p>b) D. The mass of unmelted wax was for P was the greatest as P is the poorest conductor of heat. The drinks will gain the least amount of heat from the surroundings and keep cold for the longest time.</p>
Q41	<p>a) Chemical potential energy \rightarrow heat energy \rightarrow kinetic energy \rightarrow kinetic energy</p> <p>b) The spiral spins faster more chemical potential energy from the candle is converted onto more heat energy, result in more kinetic energy of the moving air, converted into more kinetic energy of the spiral.</p>

3
END.