



RAFFLES GIRLS' PRIMARY SCHOOL

PRELIMINARY EXAMINATION 2014

Name : _____ Index No: _____ Class: P 6 _____

21 Aug 2014

SCIENCE

Attn: 1h 45min

Section A	60
Section B	40
Your score out of 100 marks	
Parent's signature	

SECTION A (30 X 2 marks)

For each question from 1 to 30, four options are given. One of them is the correct answer. Make your choice (1, 2, 3 or 4). Shade the correct oval on the Optical Answer Sheet.

1. The table below shows how some living things are classified into groups P and Q.

Group P	Group Q
Hibiscus plant Bird's nest fern	Bread mould Bracket fungus

Which one of the following correctly describes groups P and Q?

	Group P	Group Q
(1)	Flowering plants	Non-flowering plants
(2)	Reproduce from seeds	Reproduce from spores
(3)	Do not have chlorophyll	Have chlorophyll
(4)	Able to make their own food	Unable to make their own food

2. Rachel wanted to find out if the type of soil affects the growth of seedlings. She prepared five pots of seedlings of the same type, as shown in the table below.

	Pot P	Pot Q	Pot R	Pot S	Pot T
Number of seedlings planted	10	10	10	20	20
Type of soil	Clayey	Clayey	Garden	Garden	Clayey
Amount of water given to seedlings daily (ml)	20	10	20	10	20
Average height of seedlings at beginning of experiment (cm)	20	15	20	20	15

Which of the following setups should she use to ensure a fair test?

- (1) P and R
 - (2) Q and R
 - (3) Q and S
 - (4) S and T
3. The diagrams below show the life cycles of two animals.

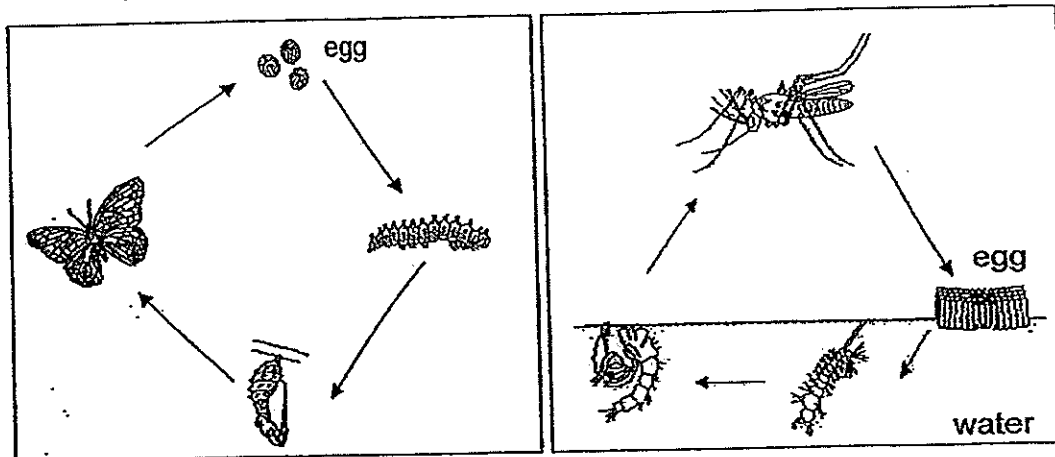

Based on the diagrams above, in what way(s) is/are the life cycles of the two animals similar?

- A Each life cycle has an egg stage.
- B The young does not resemble the adult.
- C The animal spends at least one stage of its life cycle in water.

- (1) A only
- (2) A and B only
- (3) B and C only
- (4) A, B and C

4. Jill set up an experiment as shown in the diagrams below. In setup A, she placed three seeds from plant X in the beaker. In setup B, she placed three seedlings with young leaves from plant X in the beaker.

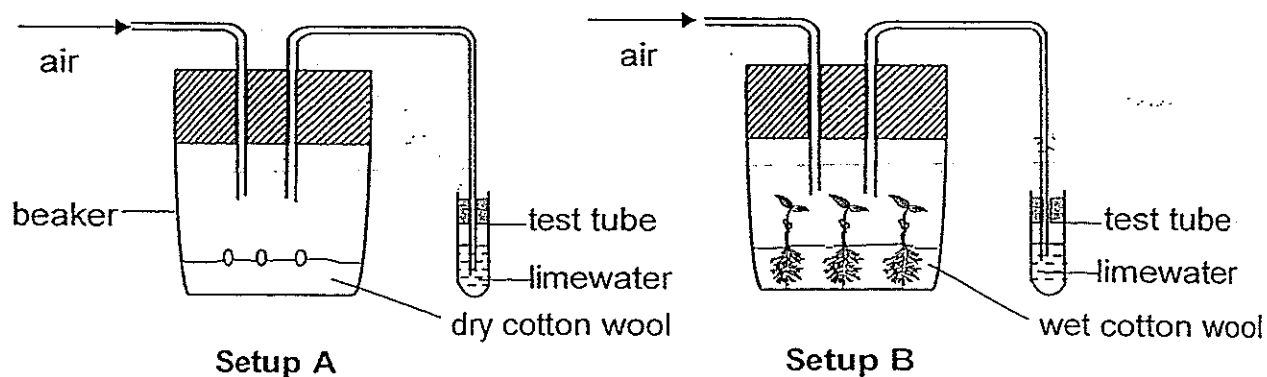

Both setups were placed in a dark cupboard for two hours. Limewater will turn chalky in the presence of carbon dioxide.

What will Jill most likely observe after ^{two} ~~five~~ hours?

- (1) The seedlings in setup B will wither and die.
 - (2) Only the limewater in setup B will turn chalky.
 - (3) The limewater in both setups, A and B, will remain clear.
 - (4) The seeds in setup A will germinate and young leaves will appear.
5. The diagrams below show the cross-sections of flowers A, B and C. Flowers A and B are of the same species. Part X and part Y carry out the same function.

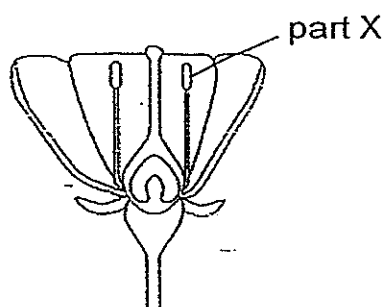

Flower A

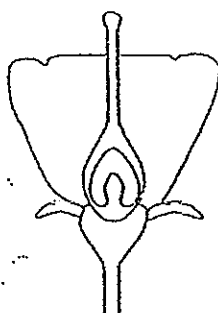

Flower B

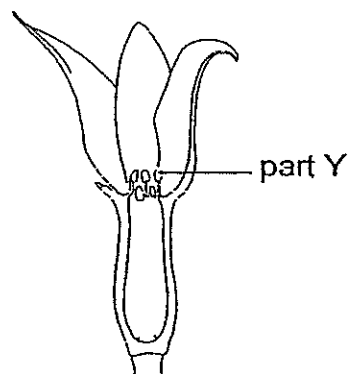

Flower C

Which one of the following statements is correct?

- (1) Flower C can be fertilised.
- (2) Only flower B can develop into fruit.
- (3) Pollen grain can be transferred from flower A to flower B.
- (4) Each fruit developed from flowers A and B will have many seeds.

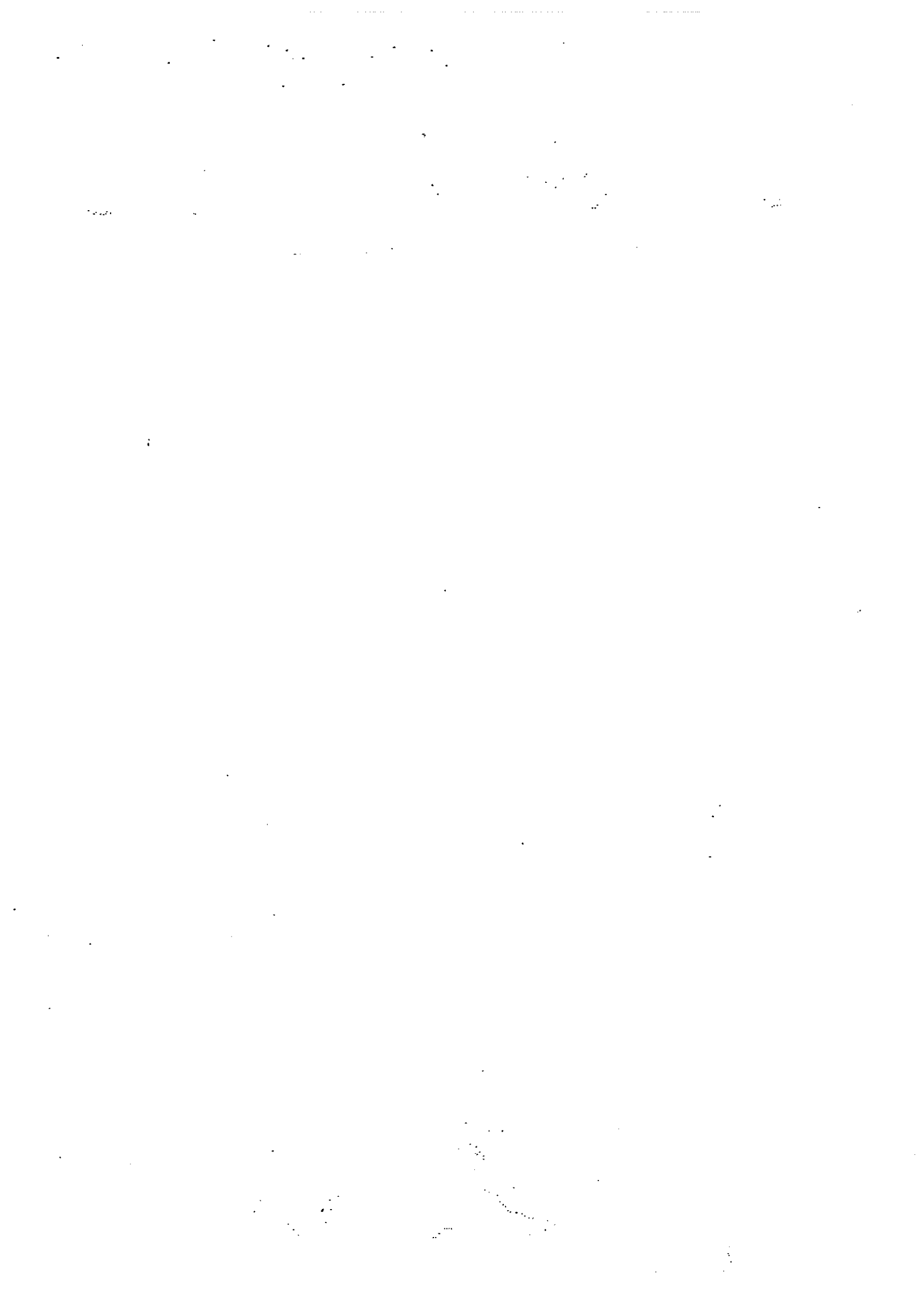

6. Elsa has four different types of fruits, P, Q, R and S. She dropped them at the same time from 5th storey of her school building.

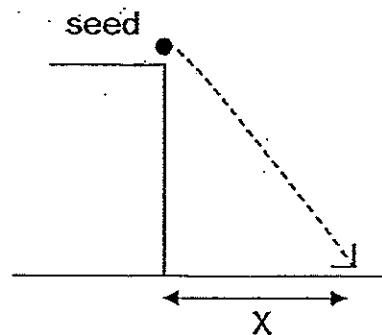

Elsa recorded the distance, X , that each seed travelled in the air before reaching the ground in the table below.

Type of seed	P	Q	R	S
X (cm)	50	250	60	700

Which one of the following statements is definitely true?

- (1) Fruits P and R must be dispersed by water.
- (2) Fruit P will travel further than fruit S in a more windy condition.
- (3) Fruit Q stayed in the air for a shorter period of time than fruit R.
- (4) Fruit S stayed in the air for the longest period of time before reaching the ground.

7. Study the diagram below.

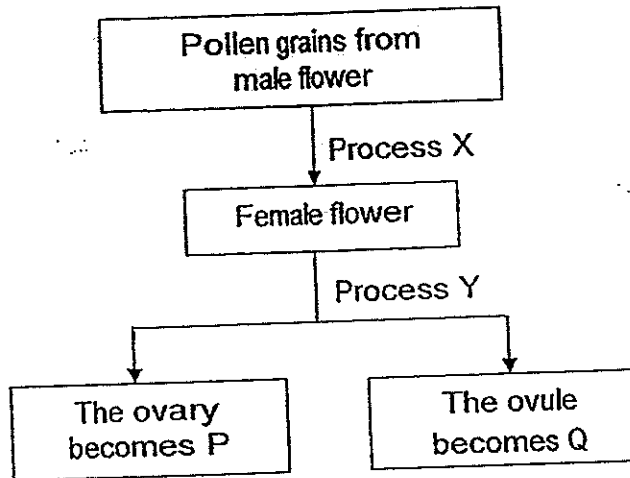

Which one of the following correctly identifies X, Y, P and Q?

	Processes		Parts of the plant	
	X	Y	P	Q
(1)	fertilisation	pollination	seed	fruit
(2)	pollination	fertilisation.	fruit	seed
(3)	pollination	fertilisation	seed	fruit
(4)	fertilisation	pollination	fruit	seed

8. The diagram below shows some blood vessels in a human circulatory system. Blood samples were taken from different blood vessels A, B, C and D. The direction of blood flow is represented by the arrows in the diagram.

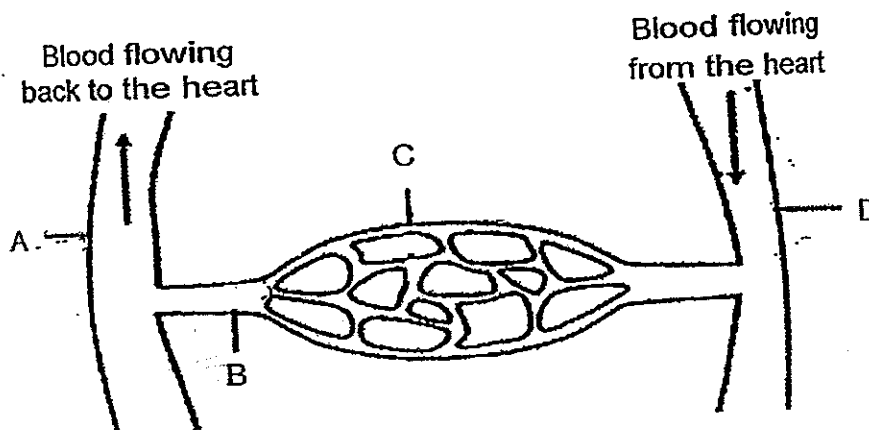

Which one of the following comparisons is correct?

- (1) Blood sample in A has more oxygen than that in C.
- (2) Blood sample in D has more oxygen than that in B.
- (3) Blood sample in C has more carbon dioxide than that in B.
- (4) Blood sample in D has the greatest amount of carbon dioxide.

9. The diagram below shows the human digestive system.

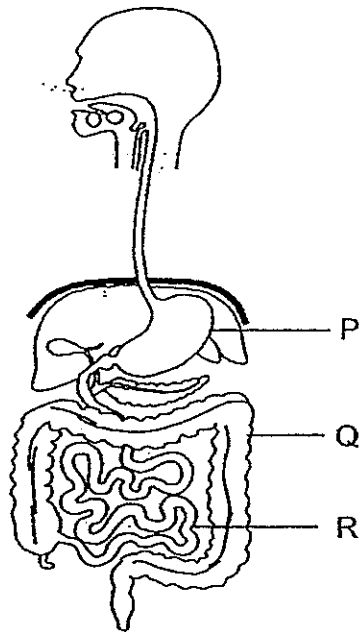

Which one of the following correctly indicates the change in the amount of undigested food in parts P, Q and R, of the above digestive system?

	P	Q	R
(1)	Increases	Increases	No change
(2)	Decreases	Decreases	No change
(3)	Increases	No change	Increases
(4)	Decreases	No change	Decreases

10. Ahmad used a knife to cut away the outer ring of the stem at part X and part Y of a plant as shown below.

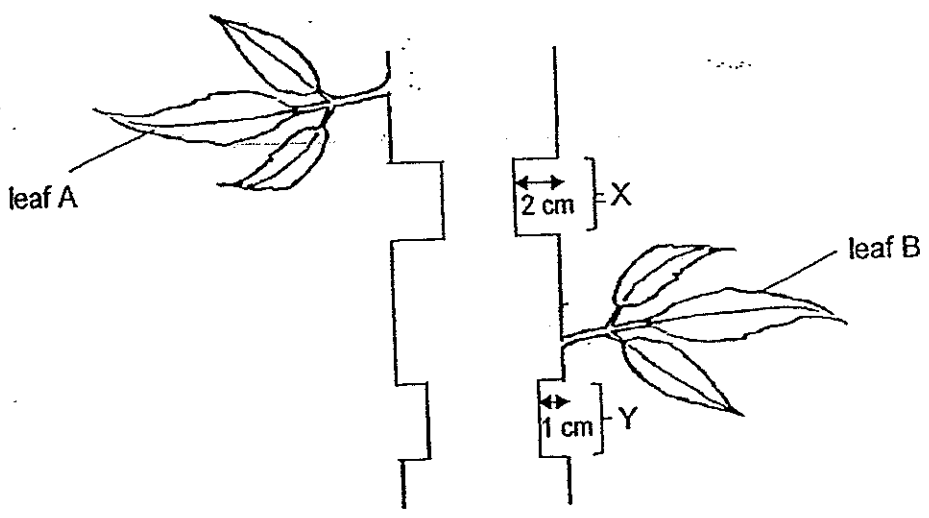

After 5 days, Ahmad noticed that leaf A withered while leaf B survived.

Which of the following statements is/are correct?

- A The water-carrying tubes at Y were removed.
- B The water-carrying tubes at X were removed.
- C The food-carrying tubes at both X and Y were still present.

- (1) B only
- (2) A and B only
- (3) B and C only
- (4) A, B and C

11. Aisha observed two cells under a microscope. She recorded the cell parts that are present in each cell in the table below. A tick (✓) indicates the presence of the cell part.

Cell Parts	Cell P	Cell Q
Cell wall	✓	
Cell membrane	✓	✓
Chloroplast		
Cytoplasm	✓	✓
Nucleus	✓	✓

Which one of the following statements is correct?

- (1) Cell Q could be a root cell.
 (2) Cell P could be a cheek cell.
 (3) Only cell P can carry out photosynthesis.
 (4) Cell P is a plant cell while cell Q is an animal cell.
12. The graph below shows the change in the area covered by plant A in a garden. Animal B was introduced into the garden community at point X.

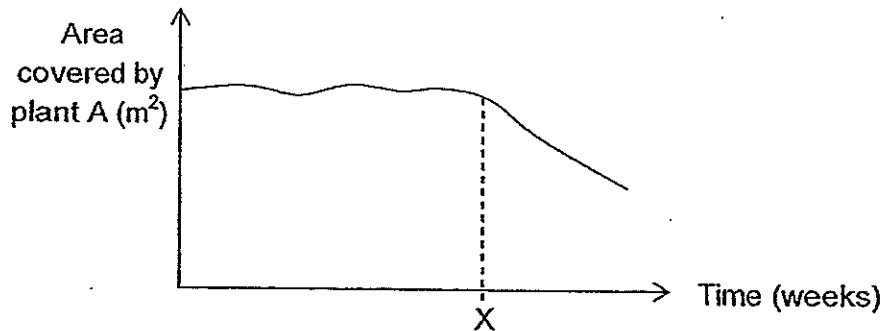

Which one of the following best explains the change in the area covered by plant A?

- (1) Animal B feeds on plant A.
 (2) Plant A provides shelter for animal B.
 (3) Plant A and animal B compete with each other for food.
 (4) The waste matter of animal B helps plant A to grow better.

13. The graphs below show how light intensity changes with depth of the pond and how the population of plant Z changes with light intensity. Plant Z is a submerged plant found in the pond.

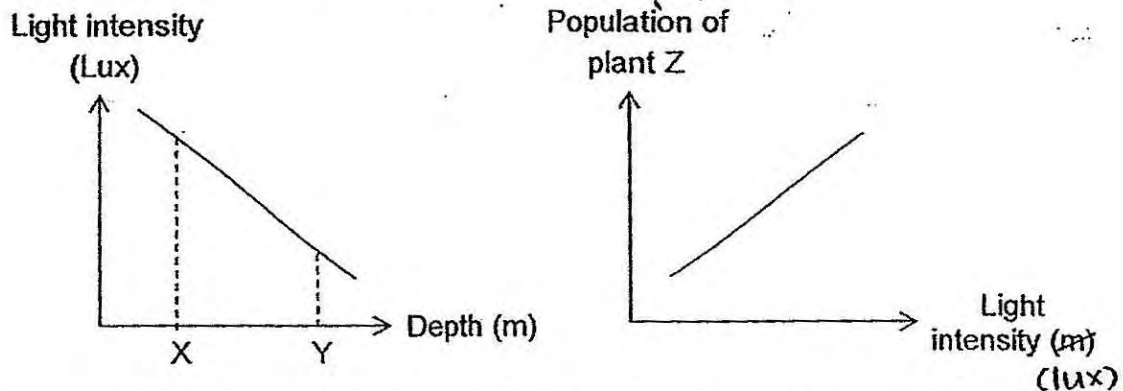

Based on the information above, which of the following statement(s) is/are most likely true?

- A The depth of the pond does not affect the intensity of light.
- B More plant Z will be found in part X than in part Y of the pond.
- C Part X of the pond will receive more light than part Y of the pond.

- (1) B only
- (2) A and B only
- (3) B and C only
- (4) A, B and C

14. The diagram below shows a food web involving organisms A, B, C and D in a certain habitat.

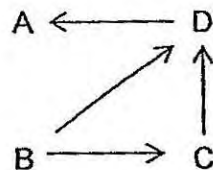

Which one of the following correctly represents A, B, C and D in this community?

	A	B	C	D
(1)	carnivore	producer	herbivore	omnivore
(2)	herbivore	producer	carnivore	omnivore
(3)	producer	carnivore	herbivore	carnivore
(4)	producer	omnivore	carnivore	herbivore

15. The diagram below shows a food chain.



Which of the following would cause a decrease in population of organism Y?

- A Hunters kill most of organisms Z.
- B Disease outbreak which kills all organisms X.
- C Introduction of new organisms which organisms Y feed on.

- (1) A only
- (2) B only
- (3) A and C only
- (4) B and C only

16. The diagram below shows bird Q and flower A.

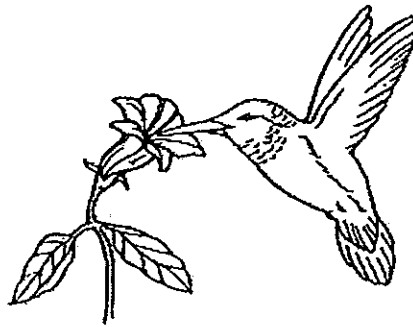

Bird Q has several adaptations to enhance its survival. It depends on flower A and some insects for food. During cold weather, its body temperature drops. During non-breeding months, its reproductive organs shrink.

Which one of the following explanations of the adaptations of bird Q is most likely to be incorrect?

- (1) It has a long and narrow beak to reach for nectar deep in the flowers.
- (2) It feeds on more than one type of food source to ensure sufficient food supply.
- (3) Its reproductive organs shrink during non-breeding months to decrease its body mass for flight.
- (4) Its body temperature drops during cold weather to reduce heat gain by its body from the surrounding.

17. Reforestation is the planting of trees on lands where there used to be forests.

Which of the following are most likely benefits resulting from reforestation?

- A More soil would be eroded.
- B More oxygen would be released into the air.
- C More carbon dioxide would be absorbed from the air.
- D More food and shelter would be available for animals.

- (1) A and C only
- (2) B and C only
- (3) A, B and D only
- (4) B, C and D only

18. The diagram below shows three organisms, A, B and C in a pond at the beginning of February. Organism C feeds on organisms A and B.

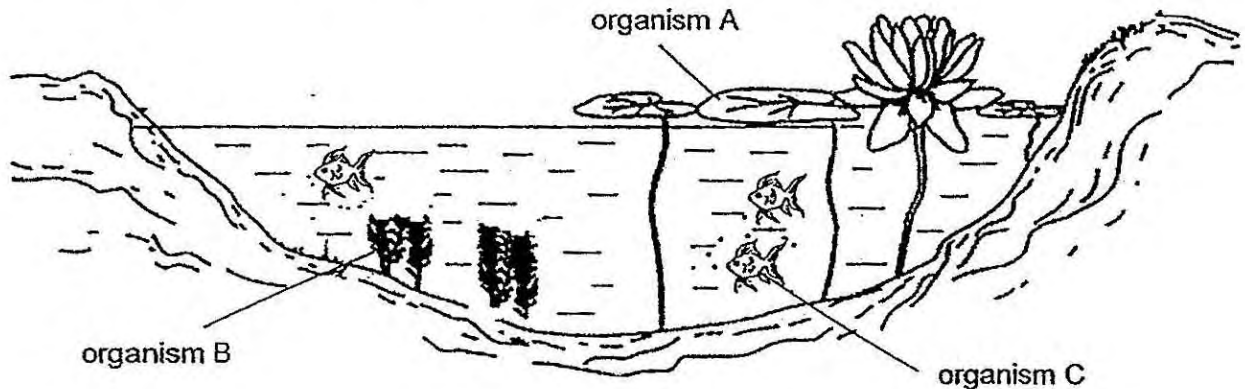

By the end of April, the population of organisms A and C had increased rapidly. However, the population of organism B decreased and eventually died out.

Based on the information above, which of the following statement(s) is/are true?

- A Organism C gets its energy from organisms A and B.
- B There is a transfer of energy from organism B to organisms A and C, causing it to die.
- C When organism B eventually died out, there will be no transfer of energy among the other organisms in the pond.

- (1) A only
- (2) C only
- (3) A and B only
- (4) B and C only

19. The table below shows some information on the properties of materials J, K, L, and M.

A tick (✓) indicates the presence of the property.

Material	Flexible	Waterproof	Does not break easily	Does not allow light to pass through
J		✓	✓	✓
K		✓		
L	✓			✓
M		✓	✓	

The helmet shown below is used by motorcycle riders to protect their heads from impact. Part X is the outer-casing of the helmet and Part Y is the clear face shield.

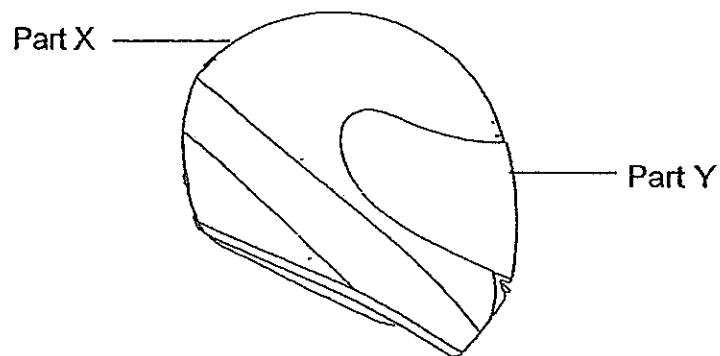

Which one of the following shows the most suitable materials for making parts X and Y of the helmet?

	Part X	Part Y
(1)	J	M
(2)	M	J
(3)	L	K
(4)	K	L

20. The flow chart below shows how some substances are classified.

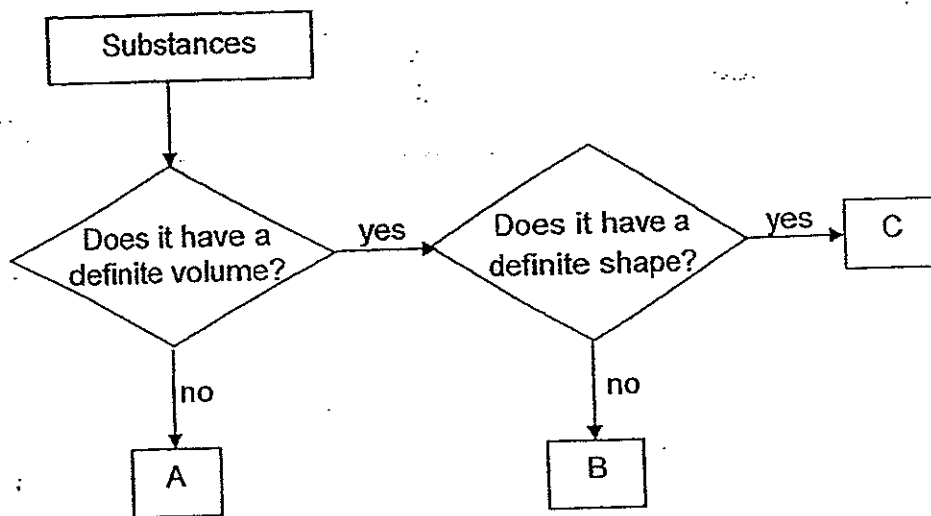

Which one of the following correctly represents A, B and C?

	A	B	C
(1)	oxygen	eraser	oil
(2)	nitrogen	glass	oxygen
(3)	cloud	milk	ruler
(4)	steam	water	eraser

21. Matthew found four objects, P, Q, R and S, of identical shape and volume but each made of a different material. He compared the masses of the objects as shown in the diagrams below.

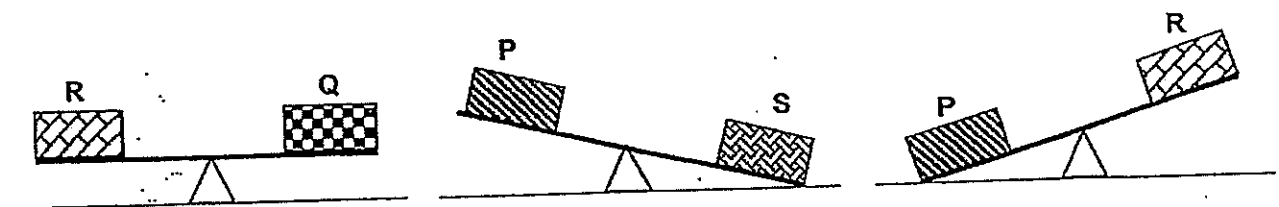

Which one of the following observations made by Matthew is definitely true?

- (1) Object R is the lightest.
- (2) Object S is the heaviest.
- (3) Object Q is lighter than object R.
- (4) Object Q is heavier than object P.

22. The circuit below consists of four identical batteries, four identical switches, S1, S2, S3 and S4, and three identical bulbs, B1, B2 and B3.

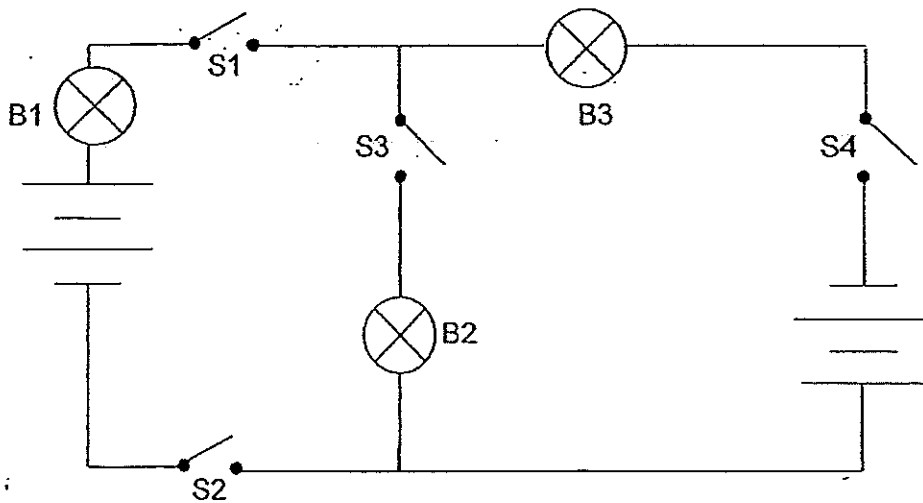

Which of the switches should be open or close such that only bulbs B1 and B3 light up?

	S1	S2	S3	S4
(1)	close	open	close	close
(2)	close	close	open	close
(3)	open	close	close	open
(4)	open	open	close	close

23. Paul constructed a circuit using wires, two identical batteries, three identical switches, S1, S2 and S3, and four objects, E, F, G and H, as shown in the diagram below. One of the objects is a light bulb.

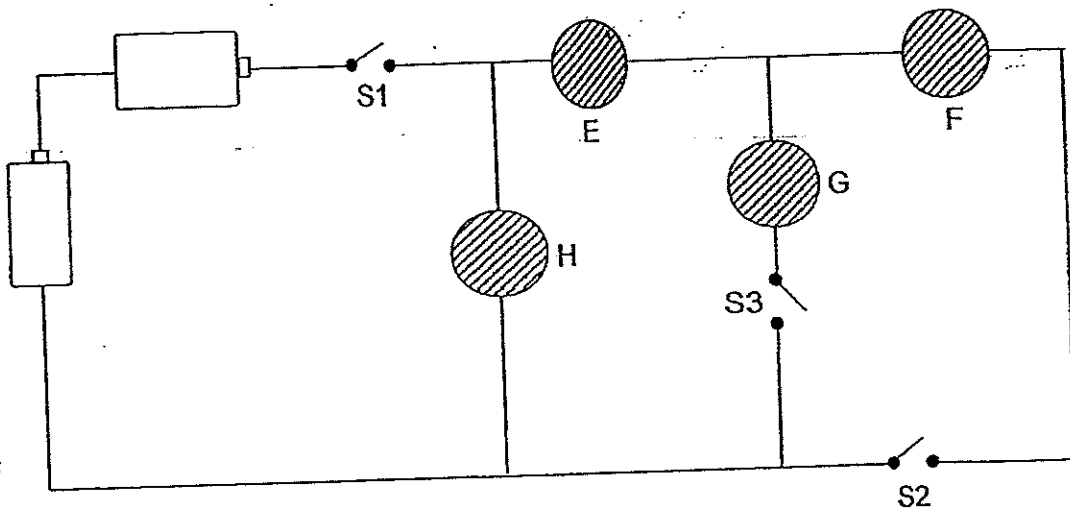

Paul made the following observations when he closed certain switches.

Switches that are closed	Observations
S1 and S3	Bulb lighted up
S1 and S2	Bulb did not light up

Which one of the following correctly represents objects, E, F, G and H?

	E	F	G	H
(1)	iron ball	glass marble	bulb	rubber ball
(2)	bulb	rubber ball	iron ball	glass marble
(3)	glass marble	iron ball	rubber ball	bulb
(4)	rubber ball	iron ball	bulb	glass marble

24. In the setup below, P, Q and R are three metal rings which pass through a smooth plastic rod.

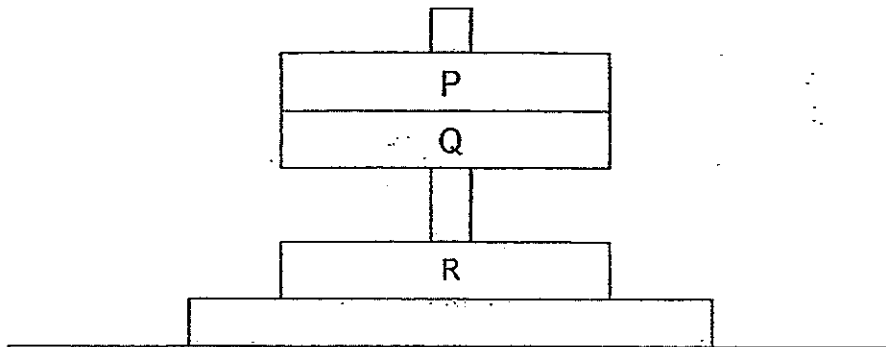

Based on the above observation, three pupils made the following conclusions:

- Sandra : Rings Q and R are definitely magnets.
Andrea : Unlike poles of rings Q and R are facing each other.
Mary : Rings P, Q and R are definitely made of magnetic materials.

Which of these pupils has/have made the correct conclusion(s)?

- (1) Sandra only
(2) Andrea and Mary only
(3) Andrea and Sandra only
(4) Sandra and Mary only
25. Mrs Wong wanted to remove the ring which was stuck on her finger of her left hand.

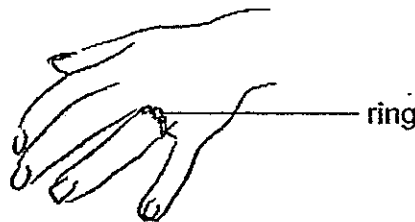

Which of the following methods will allow Mrs Wong to use her right hand to remove the ring from her finger easily?

- A Immerse the left hand into a basin of cold water to allow the ring to contract.
B Pour some oil onto the finger with the ring to increase friction between the finger and the ring.
C Pour some liquid soap onto the finger with the ring to reduce friction between the finger and the ring.

- (1) B only
(2) C only
(3) A and B only
(4) A and C only

26. Nathan used a slingshot to hit the cans as shown in the diagram below.

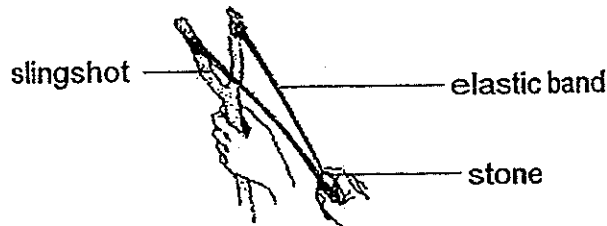
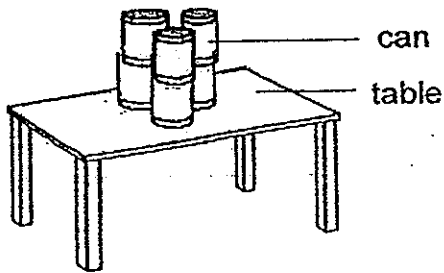

When Nathan pulled back the elastic band and then released the stone, the stone flew forward but it dropped to the ground before it could hit the cans.

Which of the following is/are possible explanation(s) for his observation?

- A Gravity pulled the stone down to the ground.
- B The elastic band was not stretched far enough.
- C Friction between the stone and the elastic band prevented the stone from reaching the cans.

- (1) A only
- (2) A and B only
- (3) B and C only
- (4) A, B and C

27. Sally constructed a setup shown in the diagram below. The setup consists of a connection of pipes with openings at A, B, C, D and E. Four identical objects X are placed inside the pipes. Both sides of each object X are smooth and reflects light well.

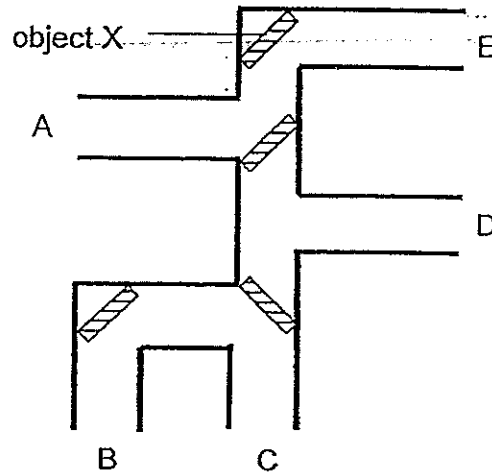

If Sally wanted to see another object Y through the pipes, which one of the following shows the positions of object Y and her eye that would enable her to see the object Y?

	Position of object Y	Position of eye
(1)	A	E
(2)	B	E
(3)	C	D
(4)	C	A

28. A can of beverage, at room temperature, is placed into a basin of water as shown in the diagram below.

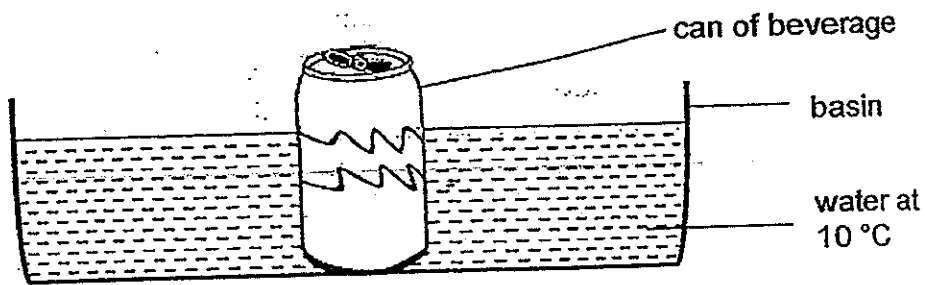

Which of the following graph represents the changes in the temperatures of the water in the basin and the beverage in the can respectively?

<u>Key</u>	
—	water
- - -	beverage

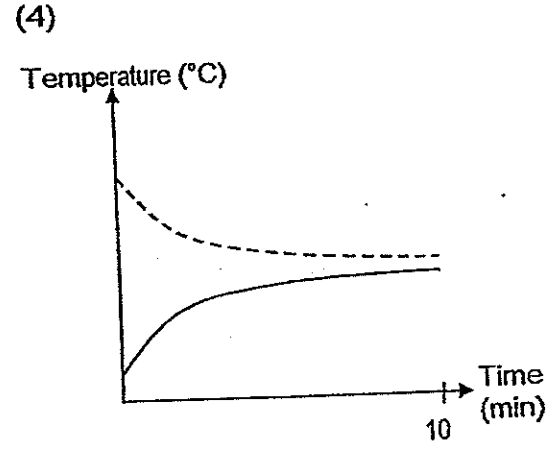
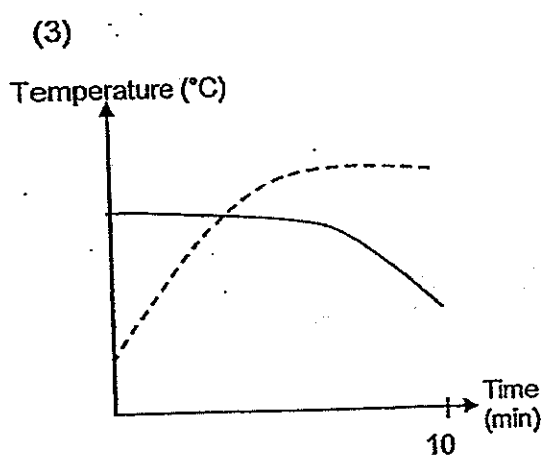
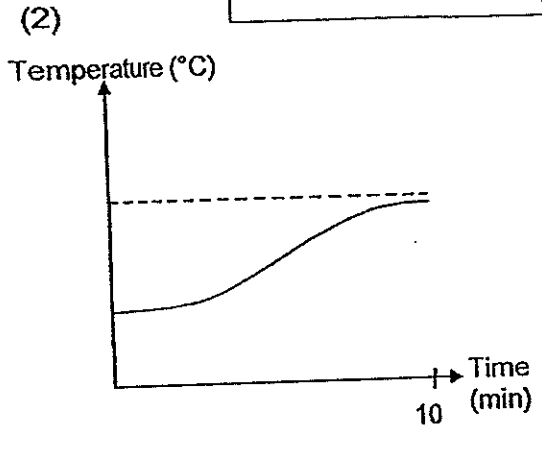
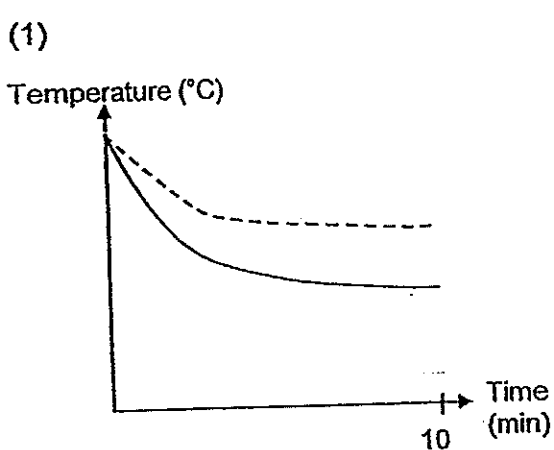

29. David set up an experiment using three identical flasks. He filled each flask with coloured water and fitted them with a narrow glass tube. The flasks were then placed in basins that had been filled with water of different temperatures at the same time. His observations on the liquid levels in the glass tubes after 5 minutes were shown below.

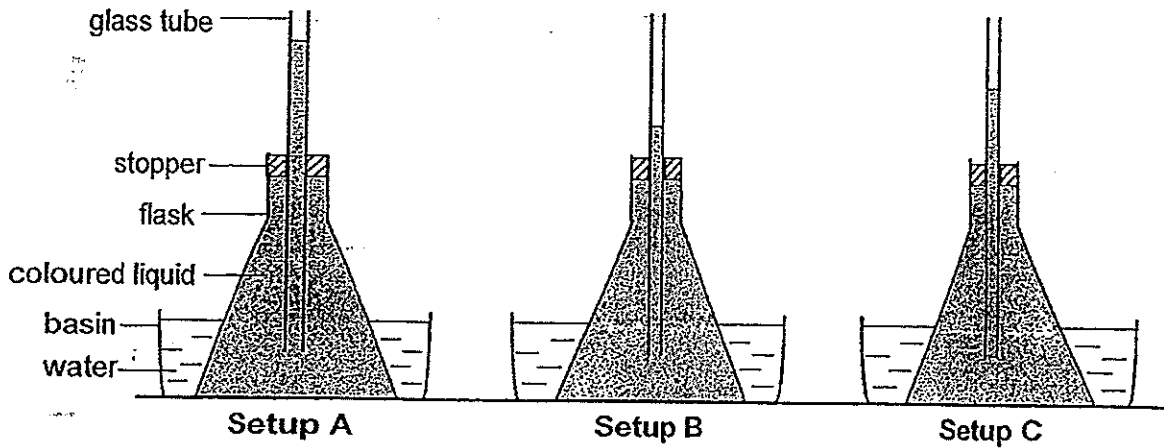

Which of the following shows the correct arrangement of the three basins of water, A, B and C, starting from the one with the highest temperature of water in the basin?

- (1) A, B, C
- (2) A, C, B
- (3) C, A, B
- (4) C, B, A

30. The diagram below shows four identical 300-g iron balls, A, B, C and D, hung from a metal pole.

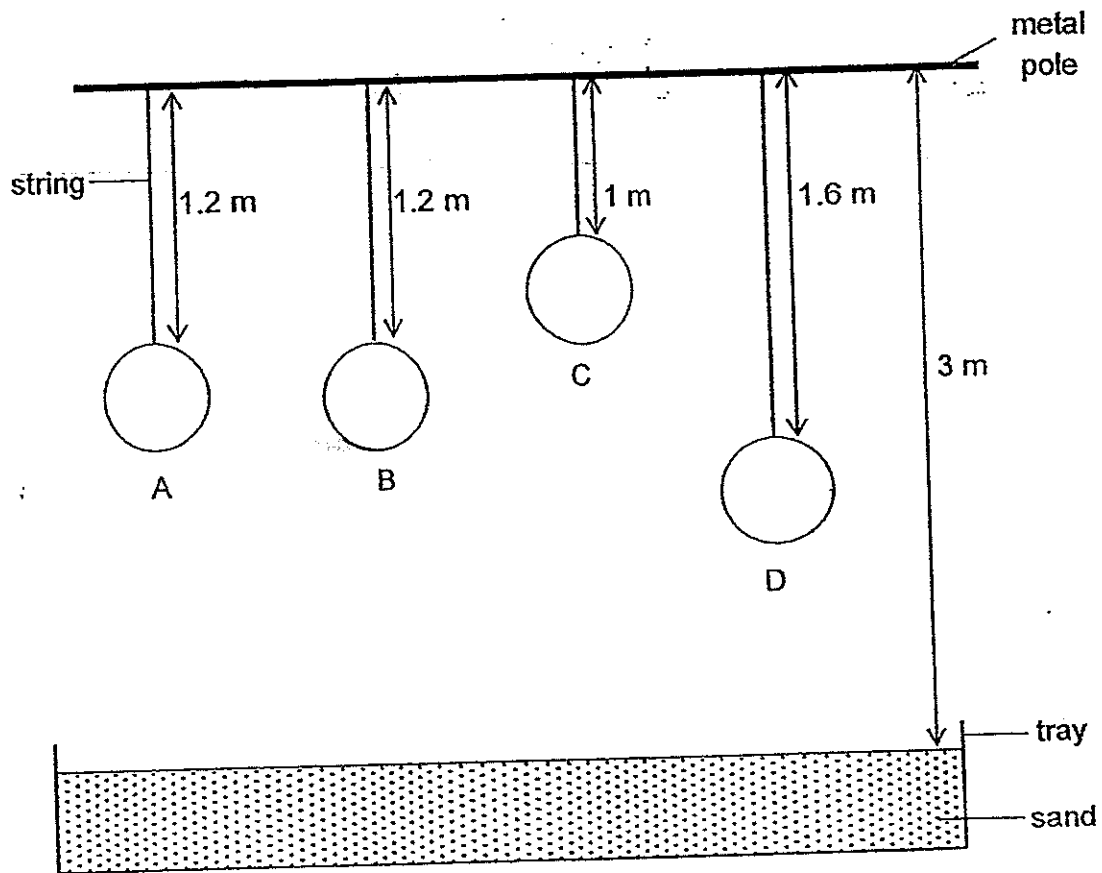

When the strings were cut, each ball created a dent in the sand.

Which of the following statement(s) is/are correct?

- A Ball C will create the deepest dent in the sand.
- B Ball D has the least amount of gravitational potential energy.
- C Balls A and B have the same amount of gravitational potential energy.

- (1) B only
- (2) A and C only
- (3) B and C only
- (4) A, B and C

SECTION B (40 marks)

For questions 31 to 44, write your answers clearly in the spaces provided.

The number of marks available is shown in the brackets [] at the end of each question or part question.

31. The chart below shows how organisms are being classified into groups P, Q, R and S.

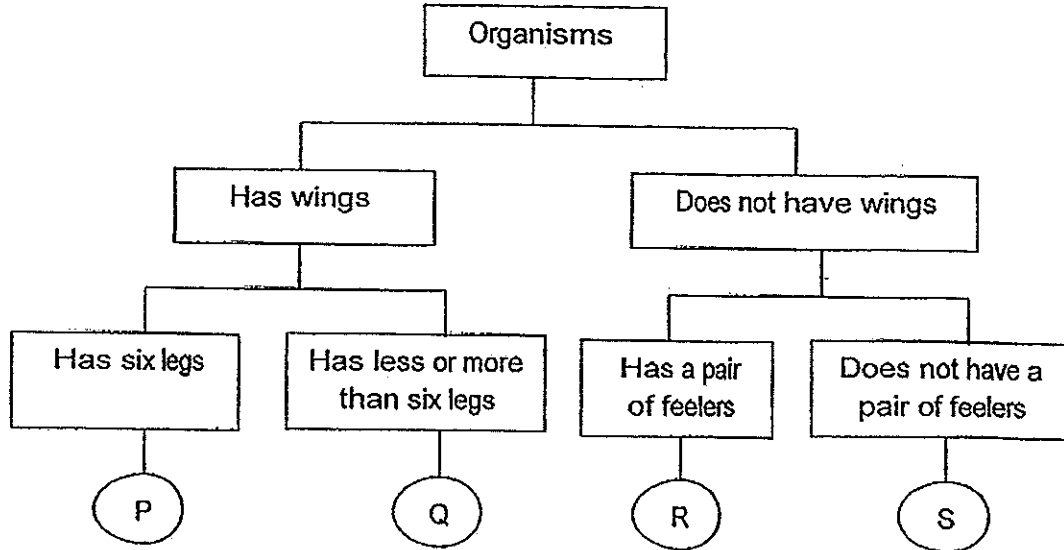

- (a) Based on the information above, describe the difference(s) between organisms P and R. [1]

- (b) Identify the group, P, Q, R or S, where the following organisms should be placed. [2]

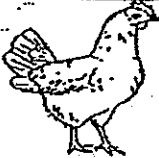
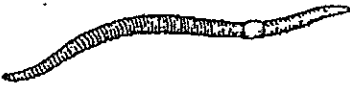
	Organism	Group
(i)		
(ii)		

32. Susan drew a female human reproductive system as shown below. However, one part of it has been removed.

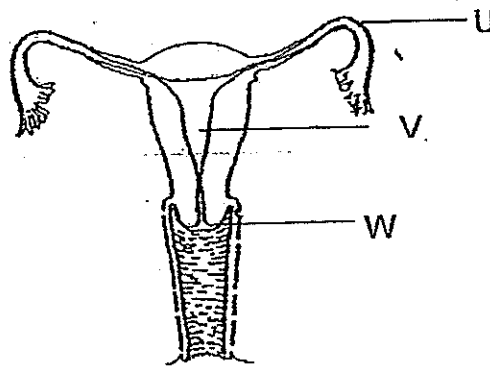

- (a) : At which part, U, V or W, would the normal development of the foetus take place if fertilisation has occurred? [1]

- (b) Susan's friend told her that fertilisation will not be able to take place in the above reproductive system naturally even in the presence of sperms. Explain why. [1]

Score	2
-------	---

33. Organism C lives in large colonies. It is commonly found in the sea and wet part of the beach during low tide, as shown in the diagram below. A variety of other types of organisms are also found on the wet beach, including the predators of organism C.

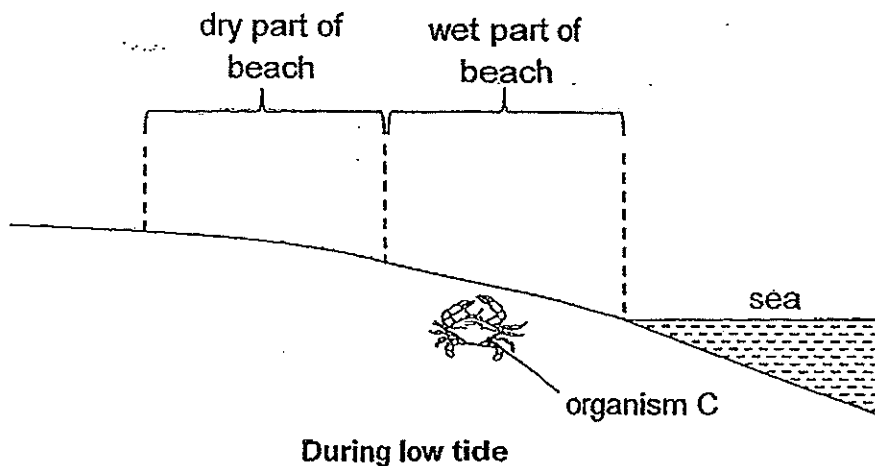

When on land, organism C will often bury itself underneath the wet part of the beach. Organism C breathes through gills that have to be kept moist at all times. It is able to breathe on land without the need to go back into the sea for a short period of time.

Based on the information above, identify and explain one behavioral adaptation of organism C that helps to enhance the chance of its survival on land. [2]

Adaptation : _____

Explanation : _____

Score	2
-------	---

34. Becky filled bag A with starch solution and immersed it in iodine solution as shown below.

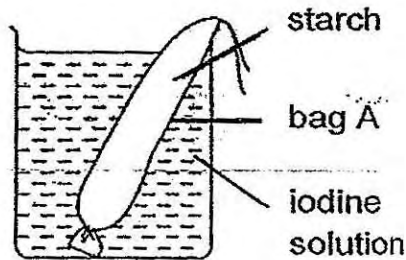

When the iodine solution comes into contact with starch, the iodine solution would change from brown to dark blue.

After one day, she observed that the content in bag A turned dark blue while the content in the beaker remained brown.

- (a) Explain her observations. [1]

The diagrams below show two cells, P and Q, which were taken from different organisms.

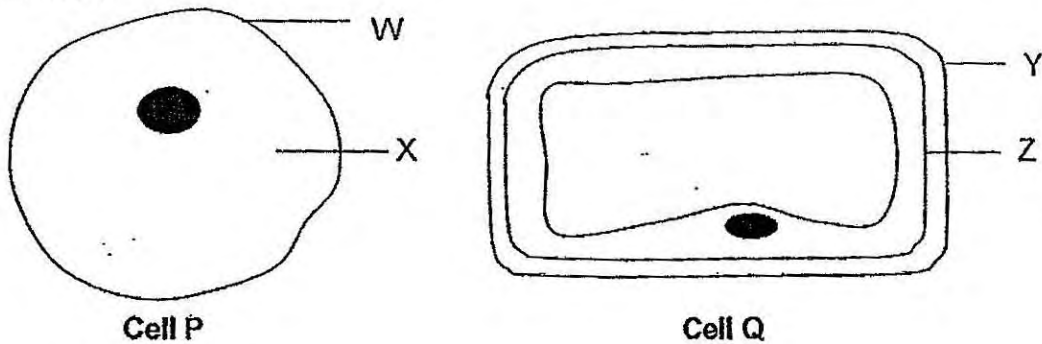

- (b) Which part(s), W, X, Y or/and Z is/are similar in function to bag A? [1]

- (c) Becky placed cells P and Q in a dish of water. After some time, one of them burst. Which cell, P or Q, will remain intact? Give a reason for your answer. [1]

Score	3
-------	---

35. Diana wanted to investigate the effect of dead leaves on liquid X. She wrapped 20 fallen leaves in a bag with tiny holes and then hung it in a beaker as shown below. Liquid X is red in colour. It turns yellow when the amount of carbon dioxide increases.

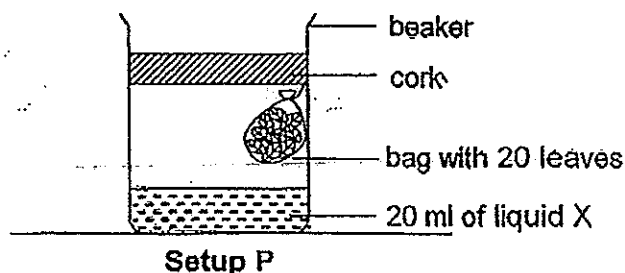

- (a) Diana's teacher commented that she needed a control setup for her experiment. Draw and label the control setup for Diana's experiment below. The beaker has been drawn for you. [1]

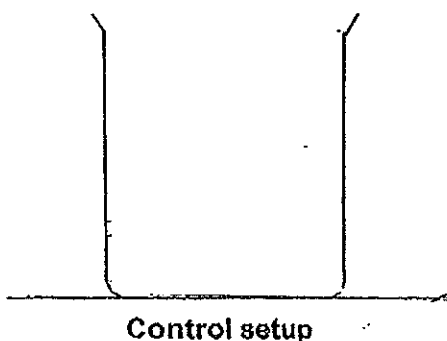

Diana left both setup P and the control setup in a room with a temperature of 25°C for 5 days. She observed that liquid X in setup P turned yellow on day 5 but not in the control setup.

- (b) Explain why there was a change in the colour of liquid X in setup P. [1]

- (c) Diana prepared another two setups, Q and R, which were similar to setup P, except that :
- Setup Q was placed in a room of temperature 35°C
 - Setup R has 10 leaves wrapped in the bag with tiny holes

Would liquid X take 'less than 5 days' or 'more than 5 days' to turn yellow for each setup? [2]

(i) Setup Q : _____

(ii) Setup R : _____

Score	4
-------	---

36. Winnie carried out an experiment on two different gas mixtures A and B in a dark room as shown below. Gas mixtures A and B contain the same type of gases. However, one of the gas mixtures has a greater amount of carbon dioxide.

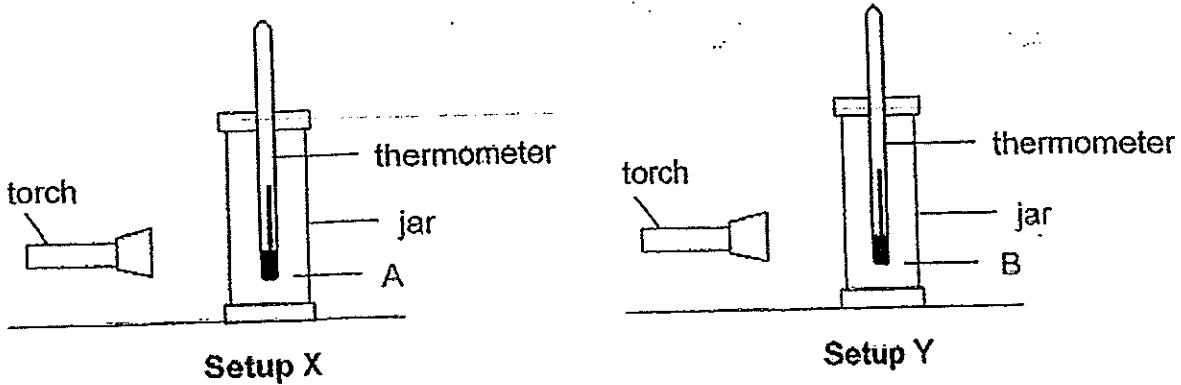

Winnie switched on the torch and recorded the temperature in each jar over a period of time. Her results are shown below.

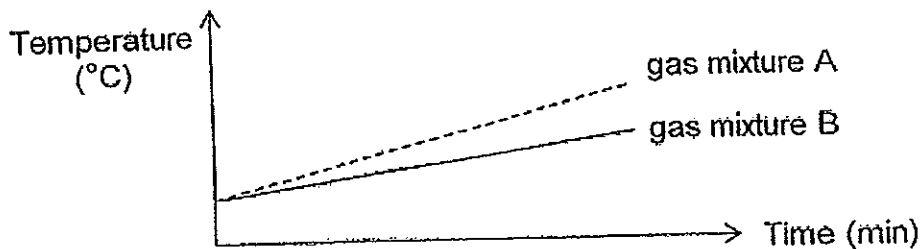

- (a) Which gas mixture, A or B, contains more carbon dioxide? Explain your answer. [2]

- (b) Explain how does the burning of large amount of fossil fuels lead to an increase in the Earth's temperature. [1]

Score	3
-------	---

37. Ryan filled up two identical cylinders with same amount of substance X and Y respectively. He placed a 500 g load on the piston of each setup.

The diagrams below show setups A and B, before and after a 500 g load was placed on the piston.

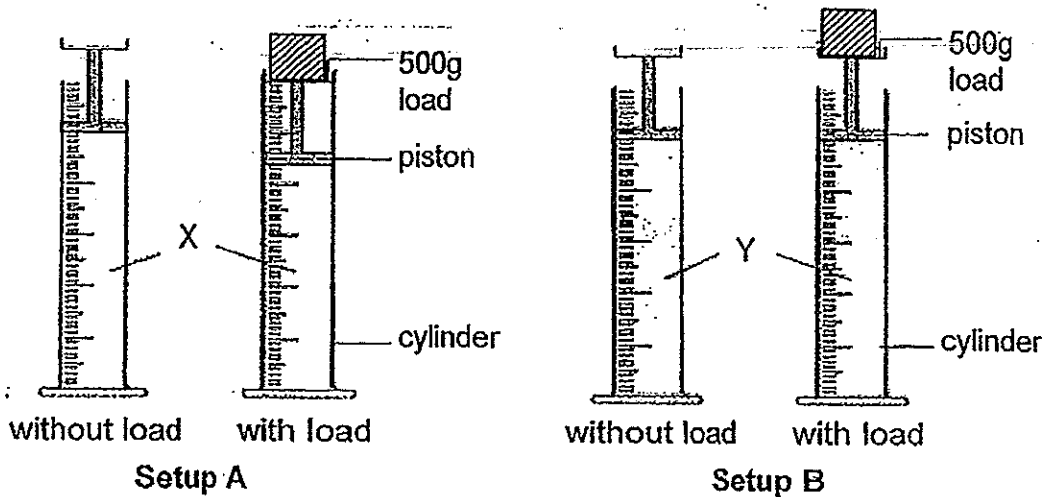

Based on the above observations, state one similarity and one difference between substances X and Y. [2]

Similarity :

Difference :

Score	2
-------	---

38. Steven used the setup below to find out if liquid R is a conductor of electricity.

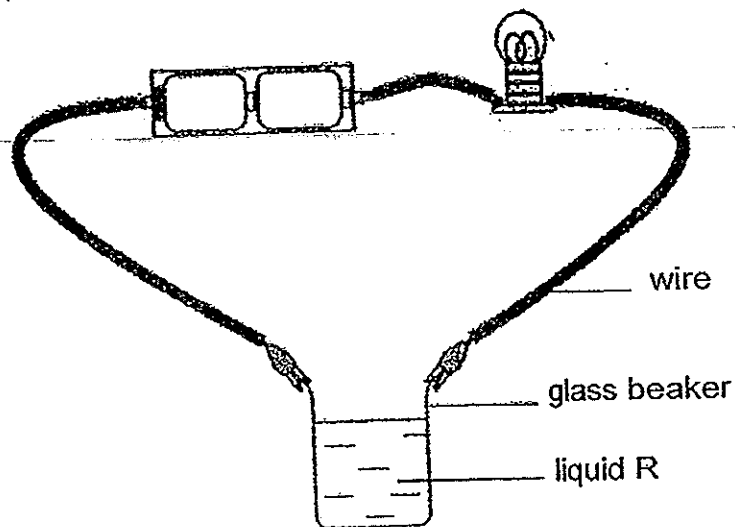

- (a) Steven observed that the bulb did not light up in the circuit. He concluded that liquid R is not a conductor of electricity. Do you agree with him? Explain your answer. [1]

Score	1
-------	---

In another experiment, Steven constructed a circuit card with six metal paper clips, A, B, C, D, E and F, which were connected on the underside of the card by wires. He used the circuit tester below to find out how the clips on the circuit card were connected.

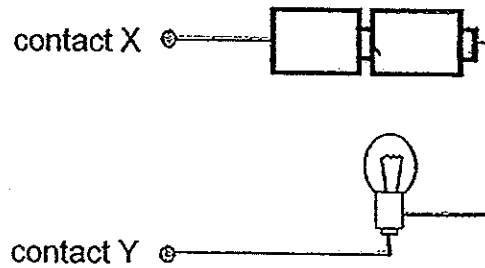

Circuit Tester

Steven connected different pairs of the metal paper clips to contacts X and Y and recorded the results in the table below.

Paper clips that are connected to contacts X and Y	Did the bulb light up?
A and E	yes
B and C	yes
B and D	no
F and C	no
E and D	yes

(b) Based on Steven's results, draw two different ways of connecting the wires in the circuit cards below. You can only use 3 wires for each way.

[2]

(i)

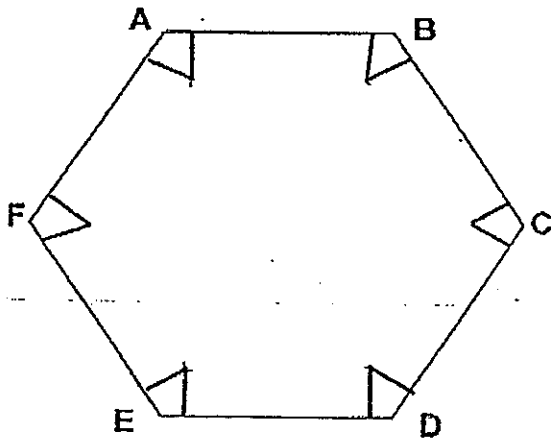

(ii)

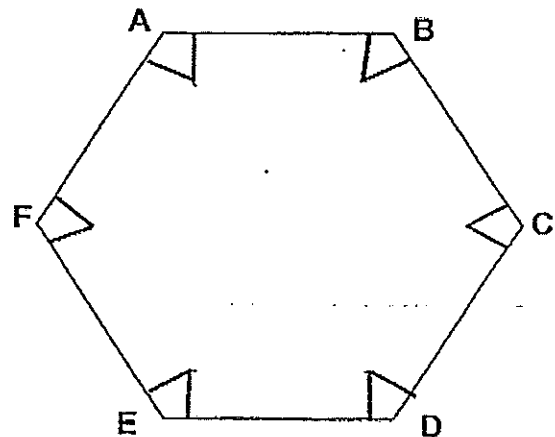

Score	2
-------	---

39. Joshua set up the experiment shown below. The iron nail was suspended at an equal distance from the two iron rods. The number of turns of wires around each iron rod is the same.

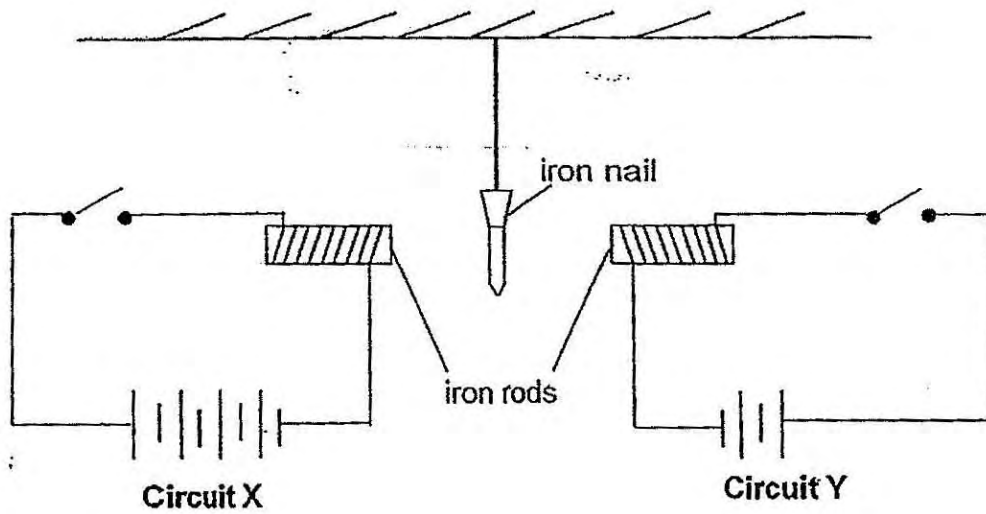

- (a) What will happen to the iron nail when both switches in circuits X and Y are closed at the same time? Explain your answer. [2]

- (b) What will Joshua observe if he replaced the iron rod with an aluminium rod in both circuits? Explain your answer. [2]

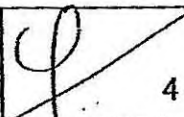
Score	
	4

40. Sam constructed a toy by inserting a rubber band through a hole in the spool. The rubber band was held in place by two sticks. He turned the longer stick several times to twist the rubber band, as shown in the diagram below.

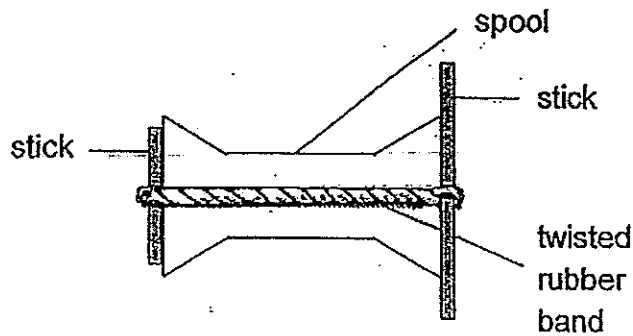

Cross section of toy

When Sam released the toy at point A on the floor, the rubber band unwound and the toy moved across the floor from point A to point B eventually came to a stop at point C, as shown in the diagram below.

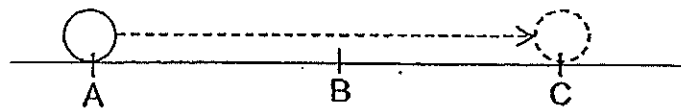

- (1) Fill in the boxes to show the energy change that took place when the toy was released on the floor at point A and moved to point B. [1]

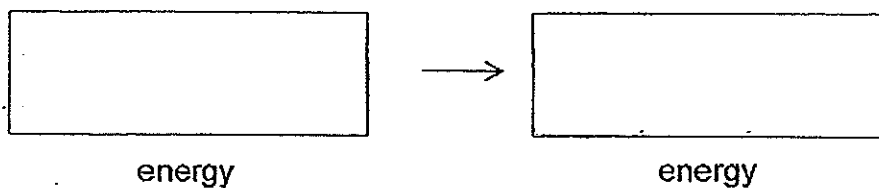

- (2) Name one force acting on the toy at point B. [1]
- (b) _____

Score	2
-------	---

41. Nicholas used the setup below to investigate the number of iron weights needed to move the box across three different surfaces, X, Y and Z.

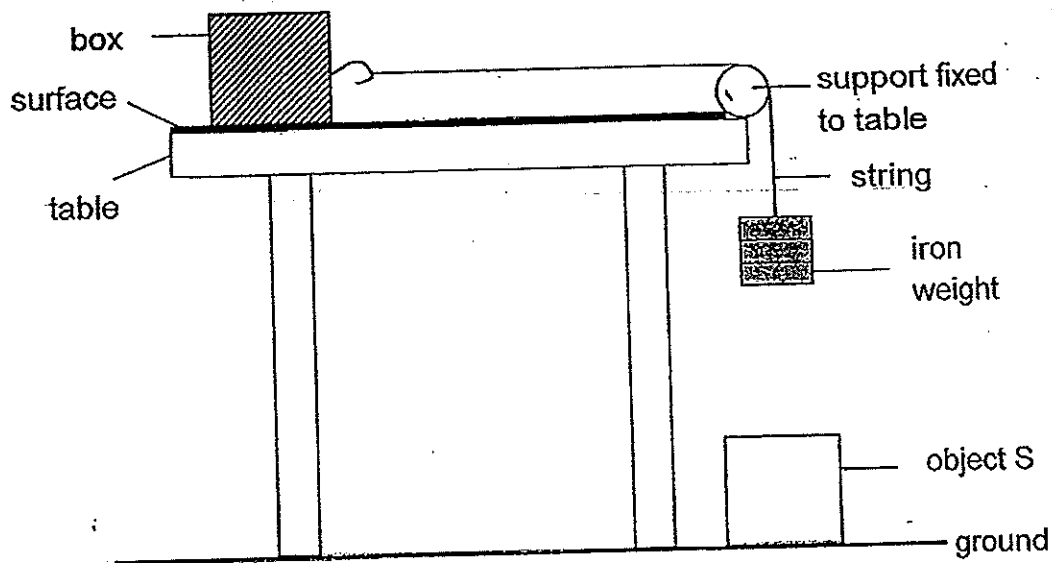

Nicholas recorded his results in the table below.

Surface	Number of iron weights
X	8
Y	5
Z	3

- (a) Explain why the number of iron weights used were the least to move the box across surface Z. [1]

- (b) Without lifting the box, suggest one way to move the box across each surface using less iron weights than the number of weights recorded in the above table. [1]

- (c) When Nicholas removed object S from the setup, he noticed that the box moved more slowly across the surface. What could object S be? Give a reason for your answer. [1]

42. Justin has three materials, A, B and C, of the same thickness. She placed materials A and B in the setup shown below and recorded the amount of light detected by the light sensor.

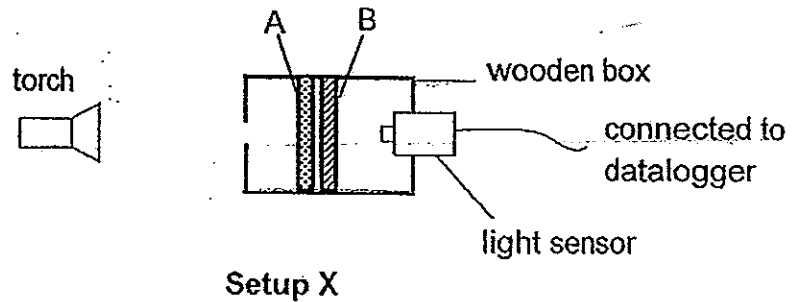

Justin repeated the experiment with different pairs of materials and recorded the amount of light detected by the light sensor in the table below.

Setup	Materials placed in the box	Amount of light detected (units)
X	A and B	200
Y	B and C	60
Z	A and C	30

- (a) Without replacing any parts of setup X, suggest one way to increase the amount of light detected by the light sensor in setup X. [1]

- (b) Justin wants to use one of the materials to make a shadow puppet such that it will cast the darkest shadow on the screen when light is shone on it. Which material, A, B or C, should she use for the shadow puppet? Explain your answer. [1]

43. Siti heated the same number of identical pebbles to the same temperature and placed them in three containers of equal size and thickness. The three containers are made from different materials, A, B and C.

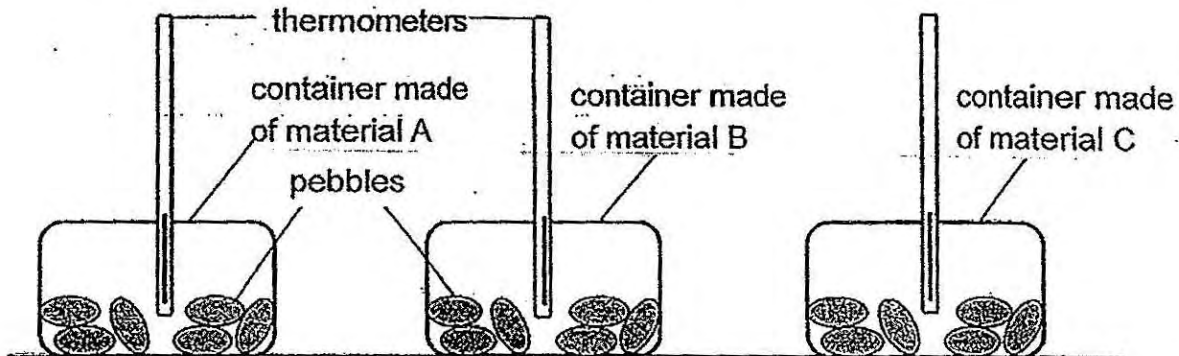

Siti recorded the temperature of the air in each container over 30 minutes. She plotted the results in the graph below. The room temperature was 25°C .

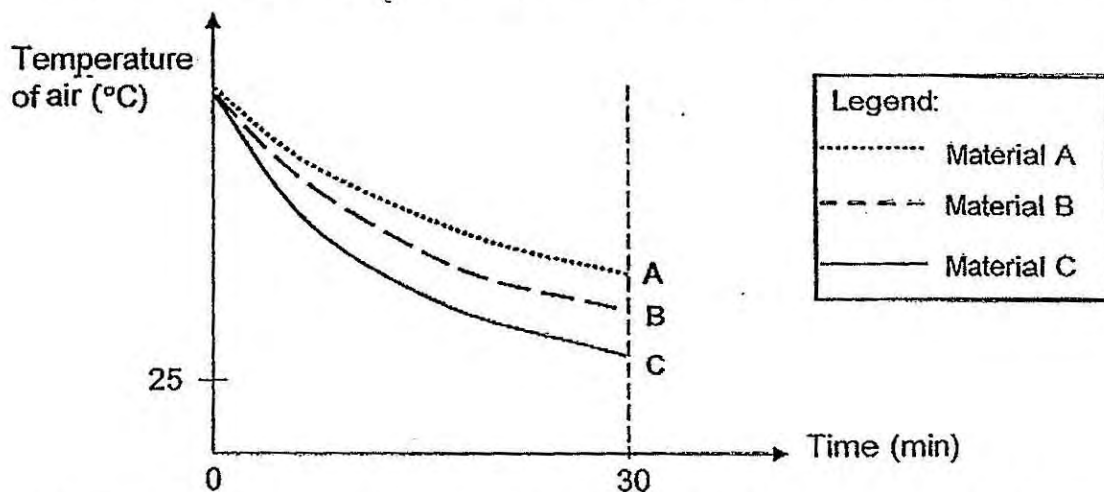

- (a) Based on the graph above, which one of the materials, A, B or C, would be most suitable to be used for making the base of a cooking pot such that food can be cooked in the shortest period of time? Give a reason for your answer. [2]

- (b) Siti left the setups in the room for another one hour. She observed that the temperature of the air in all the containers stopped decreasing after some time. Explain her observation. [1]

Score	3
-------	---

44. Alan hung a metal ball to a support using a piece of string as shown in the diagram below. When the metal ball was released from point S, it swung to point T and then to point U.

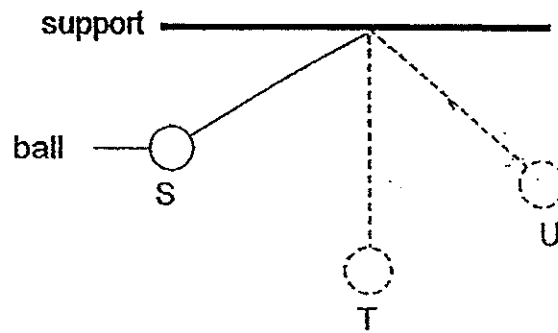

The graph below shows how the amount of energy changes as the ball swing from S to U.

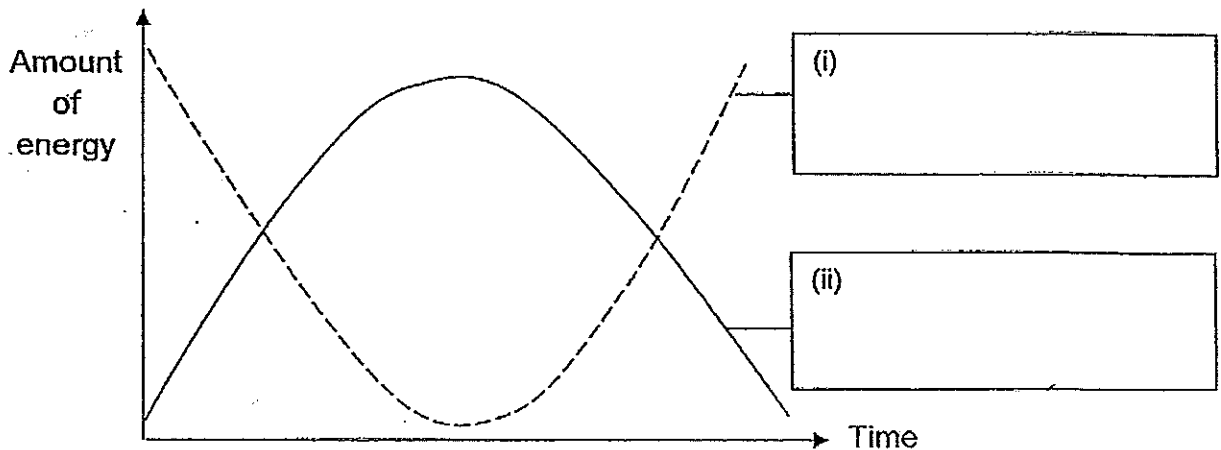

- (a) Label in the above graph the form of energy represented by each curve. [1]

- (b) When Alan released the ball at a position higher than point S, he observed that the ball swung to a position higher than point U. Explain his observation. [2]

- (c) Alan observed that the metal ball swung to and fro a few times and eventually came to a stop. Why did the metal ball eventually come to a stop? [1]

- END OF PAPER -

Setters : Ms Lim Siow Hoon, Ms Lee Suan Khim & Mdm Lim Sok Yen

Score	4
-------	---

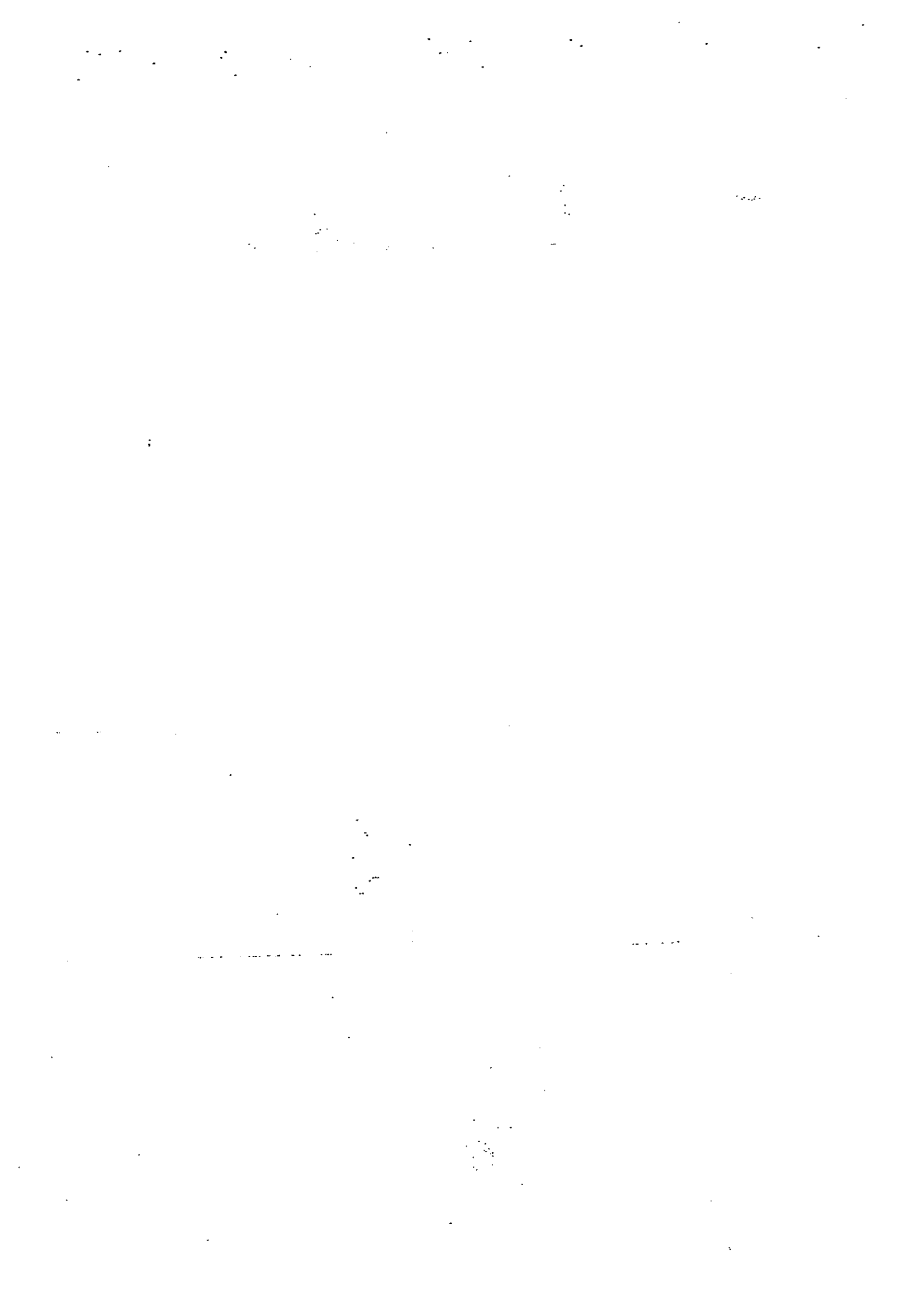

ANSWER SHEET

EXAM PAPER 2014

SCHOOL : RAFFLES GIRLS'

PRIMARY : P6

SUBJECT : SCIENCE

TERM : SA2

Q1	Q2	Q3	Q4	Q5	Q6	Q7	Q8	Q9	Q10	Q11	Q12	Q13	Q14	Q15	Q16	Q17
4	1	2	2	3	4	2	2	4	1	4	1	3	1	2	4	4

Q18	Q19	Q20	Q21	Q22	Q23	Q24	Q25	Q26	Q27	Q28	Q29	Q30
1	1	4	2	2	1	1	2	2	1	4	2	4

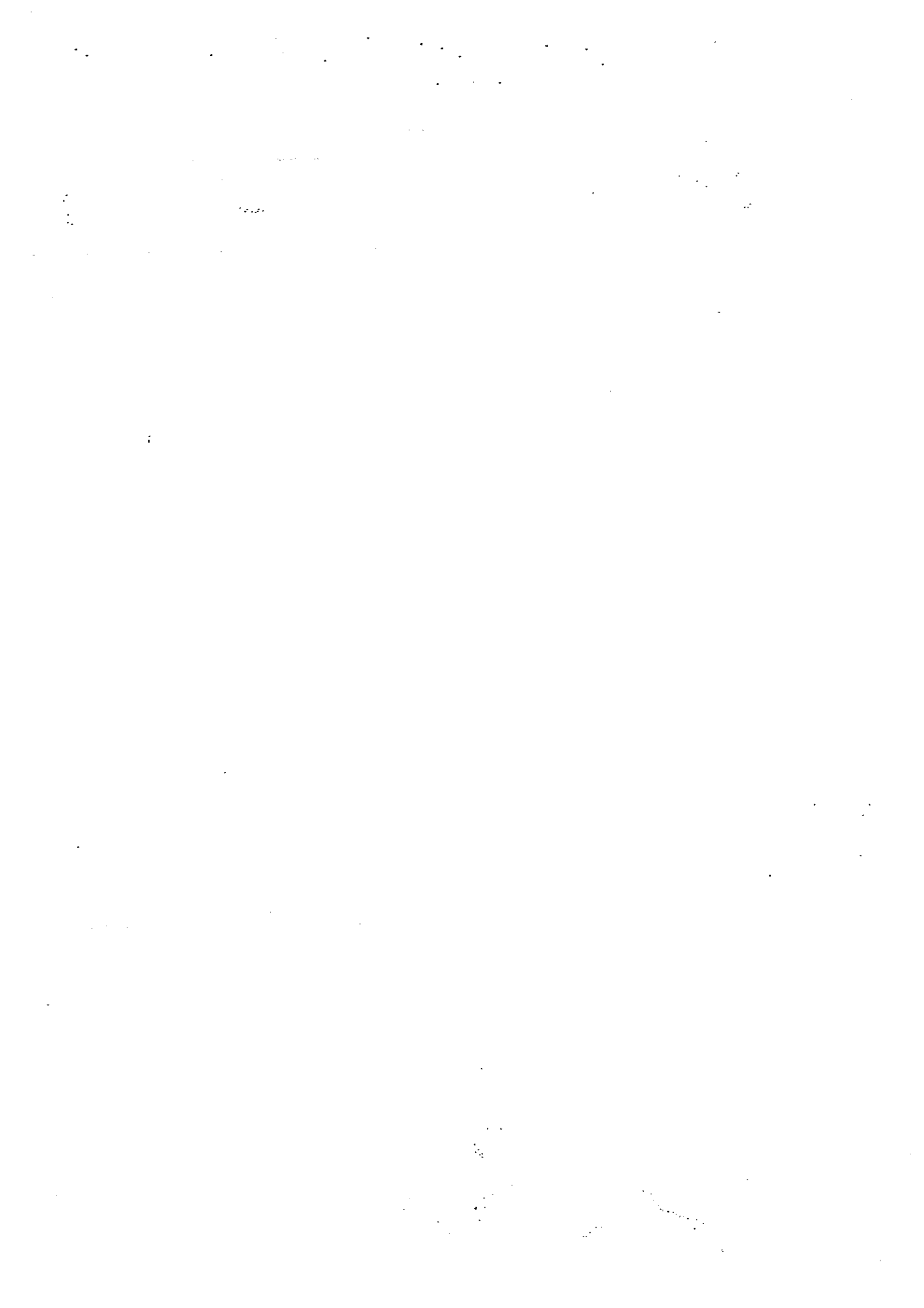

SECTION B (40 marks)

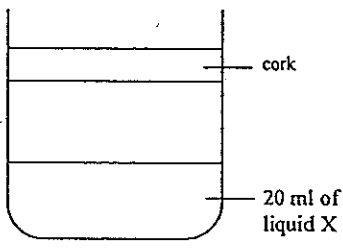
No		Suggested answers
31	a	P has wings but R does not have wings.
	b	i) Q ii) S
32	a	V
	b	There is no ovary so no egg can be released and fertilization cannot take place.
33		Adaptation: Burying itself in wet part of the beach. Explanation: To avoid detection by predators.
34	a	Bag A allows iodine solution to pass through to react with starch but it does not allow starch to pass through.
	b	W and Z
	c	Cell Q. It has cell wall to prevent it from bursting.
35	a	 <p style="text-align: center;">Control set-up</p>
	b	Decomposition of the dead leaves release carbon dioxide which turned liquid Y yellow.
	c	i) Less than 5 days ii) More than 5 days
36	a	A, more carbon dioxide will trap more heat in the jar, which results in a greater increase in temperature.
	b	Burning of large amount of fossil fuels release more carbon dioxide into the atmosphere, which traps more heat and lead to an increase in the Earth's temperature.
37		Similarity: Substance X and Y in each set-up occupies space. Difference: Substance X can be compressed while substance Y cannot be compressed.
38	a	No, I disagree. The crocodile clip was not in contact with liquid R, hence electricity cannot be conducted to R.

	b	
39	a	The iron nail will move towards the iron rod in set-up X. In set-up X, there are more batteries, the magnetic force of attraction is stronger compared to set-up Y.
	b	The iron nail will remain stationary. Aluminium is a non-magnetic material. Hence, the aluminium rod will not become an electromagnet.
40	a	Elastic potential energy \rightarrow kinetic energy
	b	Gravity
41	a	There is least friction between surface Z and the base of the box compared to surface X and Y.
	b	Apply lubricants on each surface.
	c	Object S is a strong magnet. It attracted the iron weights which in turn pulled the box faster across the surface.
42	a	Move the torch nearer to the box.
	b	Material C. Most amount of light will be blocked by C, allowing it to cast the darkest shadow.
43	a	Material C. The temperature of the air in the container, made of material C decreased the fastest. C is the best conductor of heat, allowing the food to gain heat the fastest.
	b	The temperature of the air in the containers reached the same temperature as the room after some time.
44	a	(i) gravitational potential energy (ii) kinetic energy
	b	The metal ball possesses more gravitational potential energy which can be converted to more kinetic energy.
	c	All the kinetic energy has been converted to heat and sound energy.