

NANYANG PRIMARY SCHOOL

PRIMARY 6 SCIENCE

SEMESTRAL ASSESSMENT 1  
2014

**BOOKLET A**

Date : 8 May 2014

Duration : 1 h 45 min

Name : \_\_\_\_\_ (     )

Class: Primary 6 (     )

**DO NOT OPEN THIS BOOKLET UNTIL YOU ARE TOLD TO DO SO.  
FOLLOW ALL INSTRUCTIONS CAREFULLY.**

**Booklet A consists of 19 printed pages including this cover page.**

**Section A (30 x 2 marks = 60 marks)**

For each question from 1 to 30, four options are given. One of them is the correct answer. Make your choice (1, 2, 3 or 4). Shade the correct oval (1, 2, 3 or 4) on the Optical Answer Sheet provided.

1. The graph below shows the average size of the opening of stomata found on the leaves of green plants over a period of 12 hours.

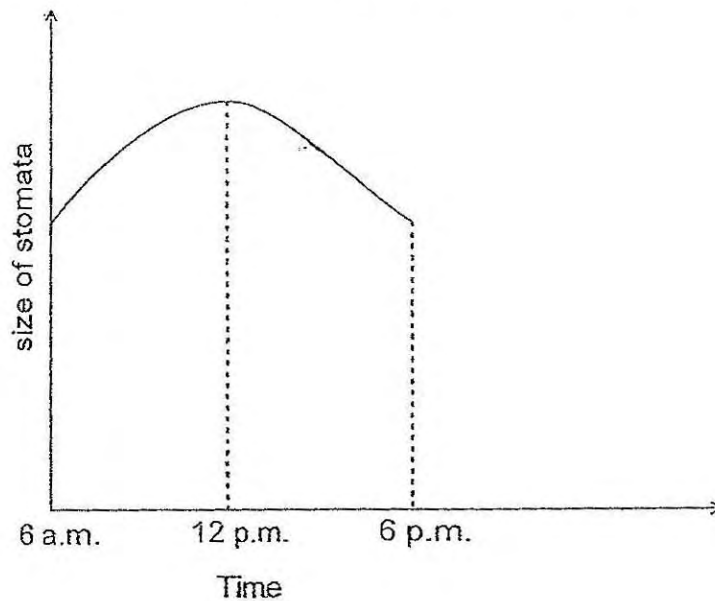

Which of the following is the main reason for the change in the size of the opening between 6 a.m. and 6 p.m.?

- (1) To allow the leaves to take in more oxygen.
- (2) To allow the leaves to take in more sunlight.
- (3) To allow the leaves to take in more carbon dioxide.
- (4) To allow the leaves to release excess water in the form of water vapour.

2. The graph below shows the rate of photosynthesis for trees A, B and C, which had been grown at an open space in the same habitat and exposed to similar conditions.

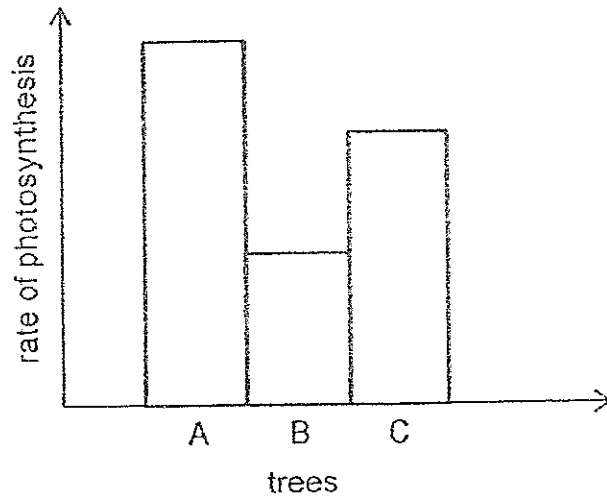

The diagram below shows the size and position of each of the trees within their habitat.

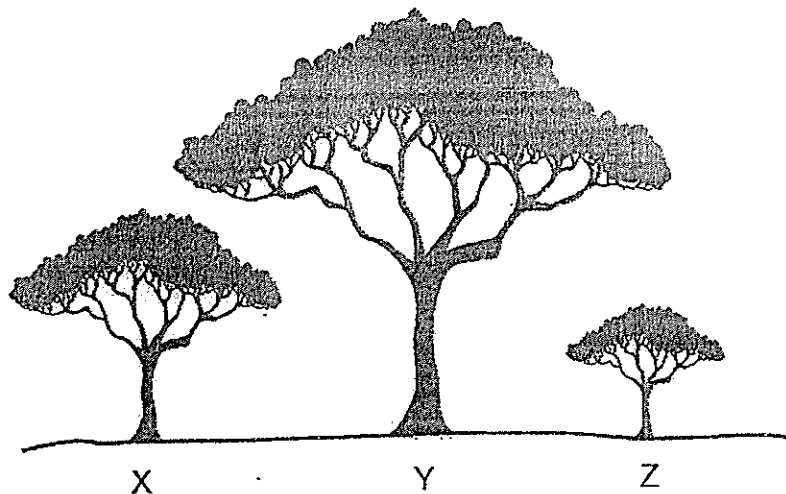

Which of the following correctly matches the trees X, Y and Z to the rate of photosynthesis shown in the graph above?

	A	B	C
(1)	Z	X	Y
(2)	X	Z	Y
(3)	Y	Z	X
(4)	X	Y	Z

3. Michael covered different parts of a leaf with different materials as shown in the diagram below. The plant was left in the open for two days before Michael tested the leaf for the presence of starch using some iodine solution.

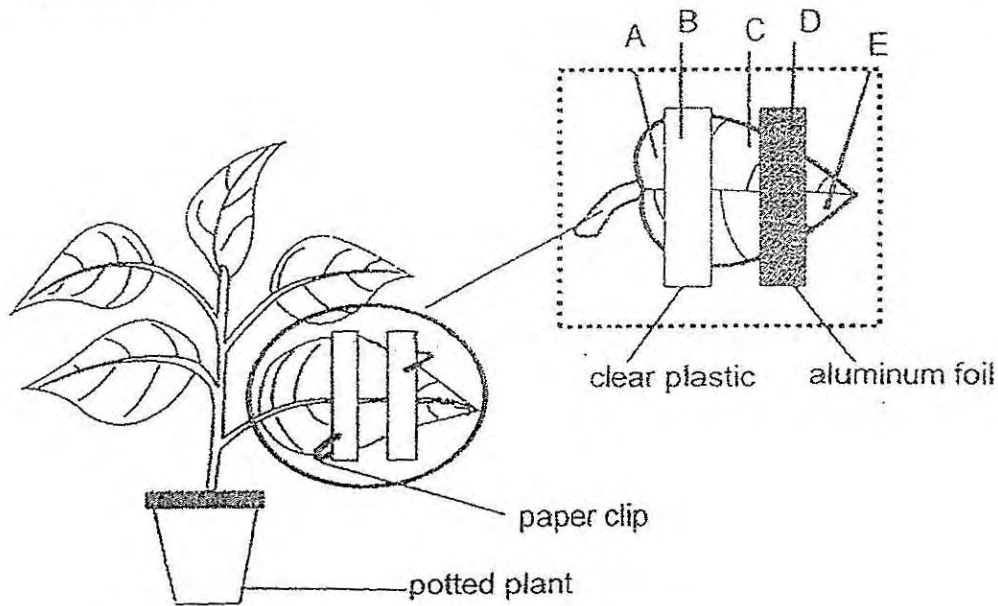

Which of the following correctly shows the most likely colour of iodine solution on the leaf?

	A	B	C	D	E
(1)	turned dark blue	remained yellowish brown	turned dark blue	remained yellowish brown	turned dark blue
(2)	remained yellowish brown	remained yellowish brown	turned dark blue	turned dark blue	remained yellowish brown
(3)	turned dark blue	turned dark blue	turned dark blue	remained yellowish brown	turned dark blue
(4)	remained yellowish brown	turned dark blue	remained yellowish brown	remained yellowish brown	turned dark blue

4. Which of the following habitats are suitable for earthworms to live in?

- A leaf litter
- B garden
- C desert

- (1) A only
- (2) A and B only
- (3) A and C only
- (4) B and C only

5. The diagram below shows a food web in a grassland community.

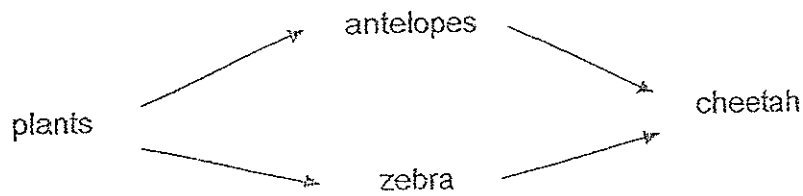

The following graph shows a change in the population size of antelopes in the community.

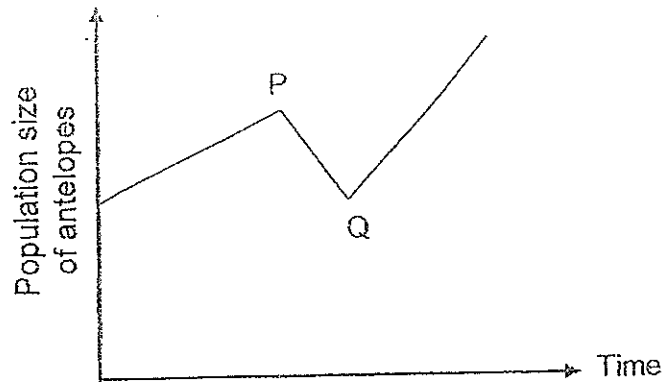

Which two of the following events could have caused the change between points P and Q?

- A There was a decrease in the amount of rain.
- B There was a decrease in the population of zebras.
- C There was an increase in the population of plants.
- D There was an increase in the population of cheetahs.

- (1) A and B
- (2) A and D
- (3) B and C
- (4) C and D

6. Which of the following statements about a pond habitat and a single tree habitat are true?

- A The plants in both habitats need sunlight to survive.
- B An organism taken from the single tree can live inside the pond
- C The organisms in the pond need more water than those in the single tree.
- D There is more oxygen available in the pond as compared to the single tree.

- (1) A and C only
- (2) B and C only
- (3) B and D only
- (4) A and D only

7. Study the food chain below



Based on the food chain, which one of the following organisms correctly represents organism A, B, C and D?

	A	B	C	D
(1)	eagle	snake	rabbit	grass
(2)	grass	rabbit	snake	eagle
(3)	grass	snake	rabbit	eagle
(4)	snake	grass	eagle	rabbit

8. The following statements on food chains were made by some pupils. Which pupil had made an **incorrect** statement?

Peter: A food chain consists only of food consumers

Ailing: A food chain shows predator-prey relationship.

Rizar: A food chain must always end with the last consumer

Devi: A food chain must always begin with a food producer

(1) Peter

(2) Ailing

(3) Rizar

(4) Devi

9. Study the food web below.

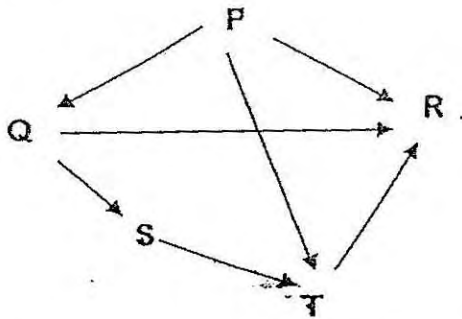

Which one of the following statements can be concluded based on the food web?

(1) R is a carnivore.

(2) T is a herbivore.

(3) P and Q are food producers.

(4) S is a prey of T but a predator of Q.

10. Serène placed a slice of moist bread inside a transparent plastic bag as shown below.

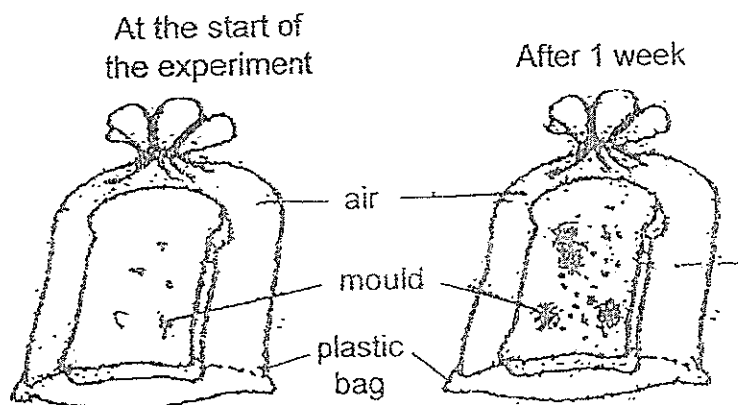

After 1 week, she made the following observations:

- The bread had shrunk in size.
- The bread had become very soggy.
- The bread was covered with green mould.

Which one of the following can be concluded based on her observations?

- (1) Bread mould gets water from the bread it grows on.
- (2) Bread mould makes food for the bread it grows on.
- (3) Bread mould breaks the bread into smaller pieces.
- (4) Bread mould breaks down the bread and releases water.

11. Jonathan had a discussion with his classmates on ways to conserve water. The following suggestions were made:

- A Fixing a leaking pipe.
- B Turning off the shower when soaping.
- C Using a basin of water to wash kitchen utensils.
- D Decreasing the time between one car wash session to the next car wash session.

Which of the above suggestions would help to conserve water?

- (1) A and B only
- (2) B and D only
- (3) A, B and C only
- (4) A, B, C and D

12. Two identical towels soaked with an equal amount of water were spread out on identical trays. They were exposed to different conditions as shown below.

	Towel A	Towel B
Temperature of surrounding	32°C	25°C
Wind	Present	Not present

If the conditions of the surrounding remain constant, which of the following graphs correctly shows the rate of evaporation of water for each towel over a period of two hours?

(1)

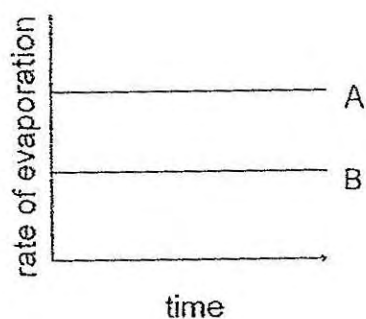

(2)

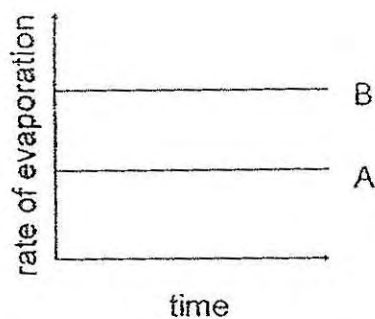

(3)

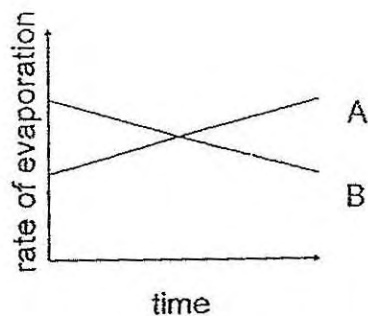

(4)

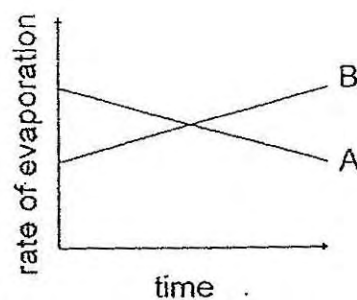



13. The diagram below shows the stages of growth of a flowering plant.

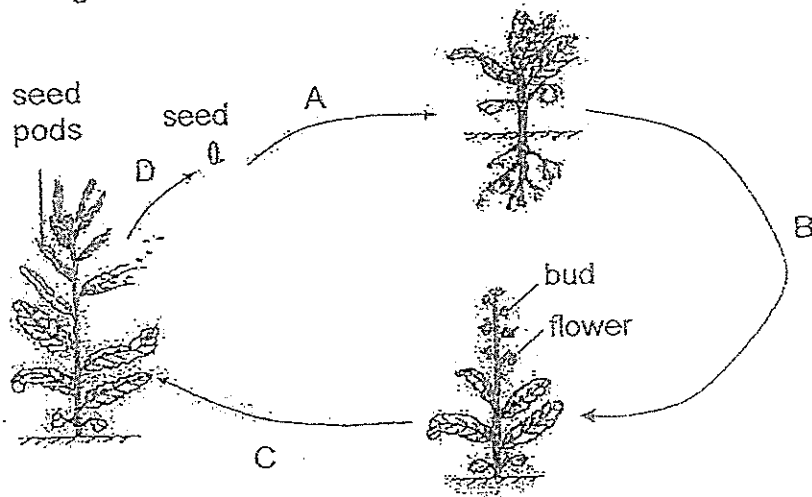

Which one of the following correctly identifies processes A, B, C and D?

	Seed dispersal	Germination	Becoming an adult plant	Pollination and fertilisation
(1)	D	B	A	C
(2)	B	D	C	A
(3)	D	A	B	C
(4)	C	A	D	B

14. Mei Mei conducted an experiment with flower P on a plant. She removed some parts of the flower. Then, she transferred pollen to the remaining parts of flower P. The flower no longer becomes a fruit after that.

Mei Mei then conducted another experiment with flower Q on the same plant. She removed some parts of flower Q. Then, she transferred pollen to the remaining parts of flower Q. After some time, flower Q formed a fruit.

Which one of the following correctly shows the parts that had most likely been removed from flowers P and Q?

	Flower P	Flower Q
(1)	stigma	anther
(2)	anther	stigma
(3)	anther	ovary
(4)	ovary	stigma

15. Ahmad had to classify the seeds of three different flowering plants.



coconut

love grass

balsam

He classified them with the help of the chart below.

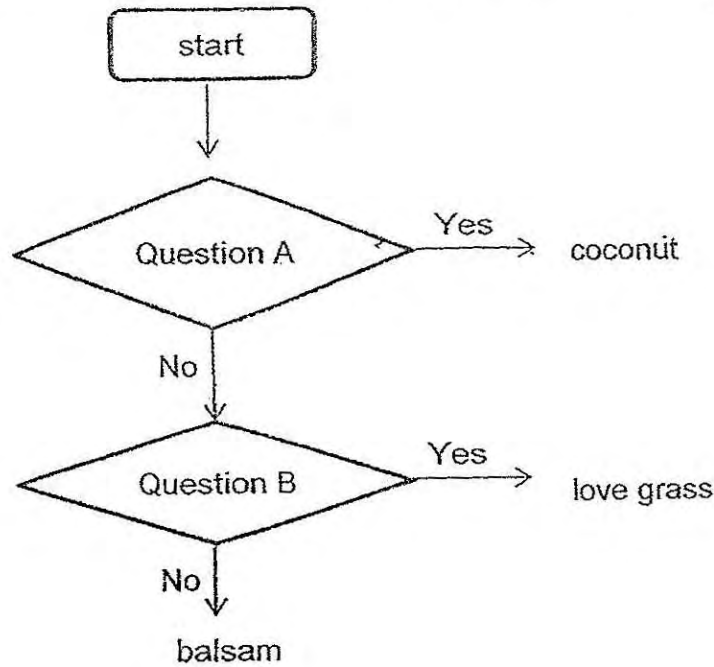

Which of the following correctly represent questions A and B?

	Question A	Question B
(1)	Are wing-like structures present?	Is a fibrous husk present?
(2)	Is a fibrous husk present?	Are wing-like structures present?
(3)	Are hooks present?	Is a fibrous husk present?
(4)	Is a fibrous husk present?	Are hooks present?

16. The diagram below shows the air sacs of the lungs of a smoker and a non-smoker. Cigarettes contain a substance known as tar which blocks the walls of the air sacs and prevents substances from passing through it.

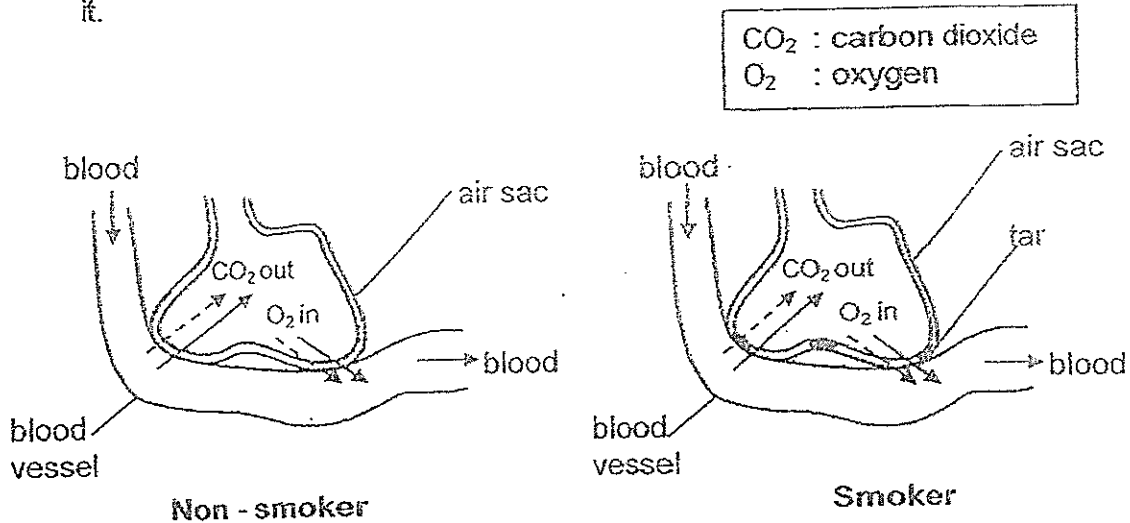

Based on the information above, which of the following statements are true?

- A The air sacs of smokers will allow less oxygen to enter the bloodstream.
  - B The oxygen that enters the bloodstream of smokers will be mixed with tar.
  - C Blood flowing in the blood vessels of a smoker is mixed with tar.
  - D To get the same amount of oxygen as a non-smoker, the smoker will have to breathe faster.
- (1) A and D only  
 (2) B and D only  
 (3) A, B and C only  
 (4) B, C and D only
17. A few passengers were trapped in a lift. The fan in the lift was not working and the lift was tightly shut.

Which one of the following correctly shows the change in the amount of air, oxygen and carbon dioxide in the lift when the passengers were trapped for 2 hours?

	amount of air	amount of carbon dioxide	amount of oxygen
(1)	decreased	decreased	increased
(2)	decreased	increased	decreased
(3)	unchanged	decreased	increased
(4)	unchanged	increased	decreased

18. The diagram below shows a cactus plant. This desert plant has white, needle-like leaves to help it reduce water loss.

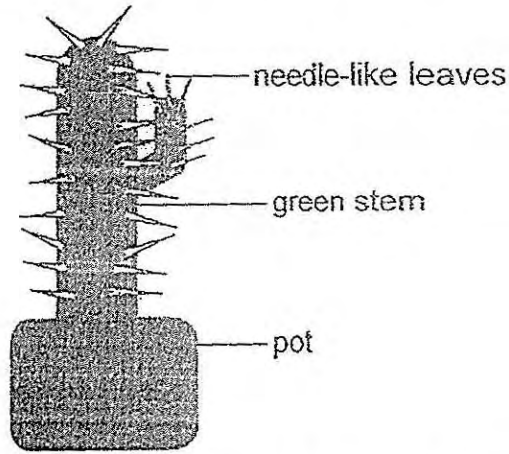

Which of the following is not found in the leaf cells of the cactus plant?

- (1) cell wall
- (2) nucleus
- (3) chloroplast
- (4) cell membrane

19. Study the diagram below which shows parts of the digestive system.

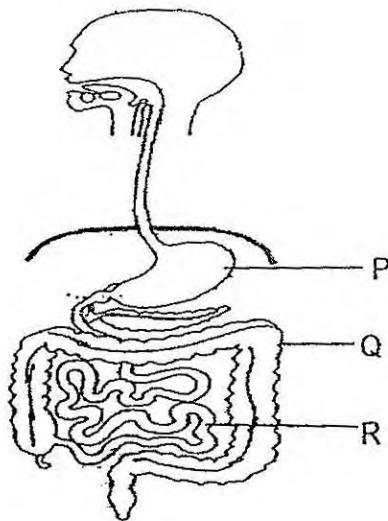

Which one of the following has been correctly matched to its function?

	absorption of digested food	absorption of water
(1)	P	Q
(2)	R	P
(3)	Q	R
(4)	R	Q

20. Study the chart below.

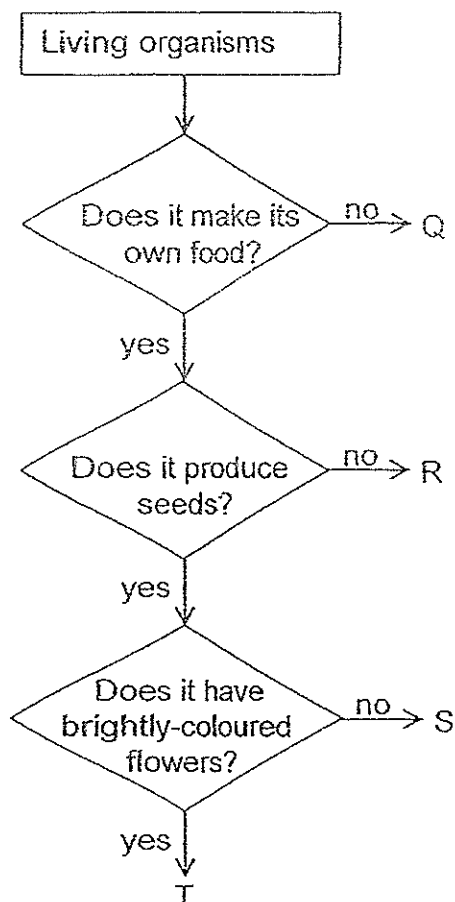

Which one of the following correctly identifies Q, R, S and T?

	Q	R	S	T
(1)	toadstool	fern	spider lily	sunflower
(2)	mushroom	moss	hibiscus	rose
(3)	fern	toadstool	spider lily	hibiscus
(4)	moss	mushroom	sunflower	spider lily

21. Which one of the following shows the correct energy conversion when a television is switched on?

(1)	Electrical Energy	→	Sound Energy	+	Heat Energy	+	Kinetic Energy
(2)	Chemical Potential Energy	→	Kinetic Energy	+	Heat Energy	+	Light Energy
(3)	Electrical Energy	→	Sound Energy	+	Light Energy	+	Heat Energy
(4)	Chemical Potential Energy	→	Kinetic Energy	+	Heat Energy	+	Sound Energy

22. Sam was playing badminton with his brother. They hit the shuttlecock between each other.

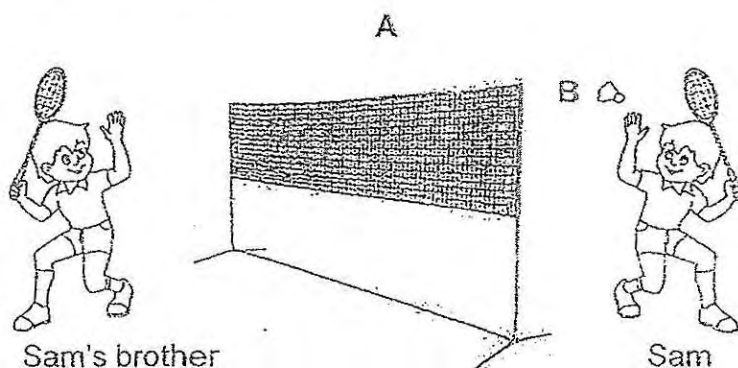

Which of the following is true when the shuttlecock moved from point B to point A?

- (1) The amount of gravitational potential energy of the shuttlecock is less at point A than at point B.
  - (2) The amount of gravitational potential energy of the shuttlecock is more at point A than at point B.
  - (3) The amount of gravitational potential energy of the shuttlecock is zero at both point A and point B.
  - (4) The amount of gravitational potential energy of the shuttlecock is the same at both points A and B.
23. A fruit dropped from a tall tree with a loud "thud" and then rolled away on the ground.

Which of the following statements correctly states the energy changes that had taken place?

- (1) Some of the kinetic energy in the fruit had been converted into heat energy.
- (2) Some of the kinetic energy in the fruit had been converted into sound energy and kinetic energy.
- (3) Some of the gravitational potential energy in the fruit had been converted into sound energy and kinetic energy.
- (4) Some of the gravitational potential energy in the fruit had been converted into heat energy and light energy.

24. The diagram below shows different energy conversions.

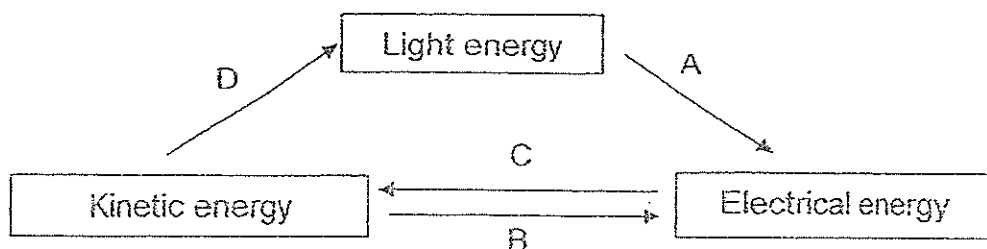

Which one of the following devices shows both energy conversions A and C when it is in use?

- |                               |                                |
|-------------------------------|--------------------------------|
| (1) a torchlight              | (2) a solar-powered calculator |
| (3) a battery-powered toy car | (4) a solar-powered toy car    |

25. Marcus conducted an experiment as shown in the diagram below. The wooden block is not attached to the spring.

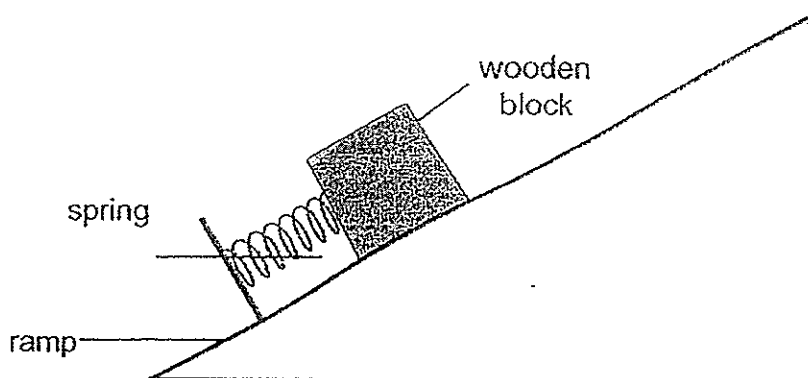

Marcus pushed the wooden block against the spring until it is fully compressed before releasing the wooden block. He then measured the distance travelled by the wooden block along the ramp. He repeated the experiment several times and found that the wooden block could only travel a maximum distance of 13 cm away from the spring.

Which of the following changes would enable the wooden block to travel a longer distance?

- A Use a longer spring of the same elasticity.
- B Apply lubricant to the surface of the ramp.
- C Use a spring that is more easily compressed.

- (1) A only
- (2) A and B only
- (3) B and C only
- (4) A, B and C

26. The diagram below shows a toy known as "spring rainbow". By pulling one end of the spring towards position 1, the toy would start moving downwards continuously on its own until it reaches position 5.

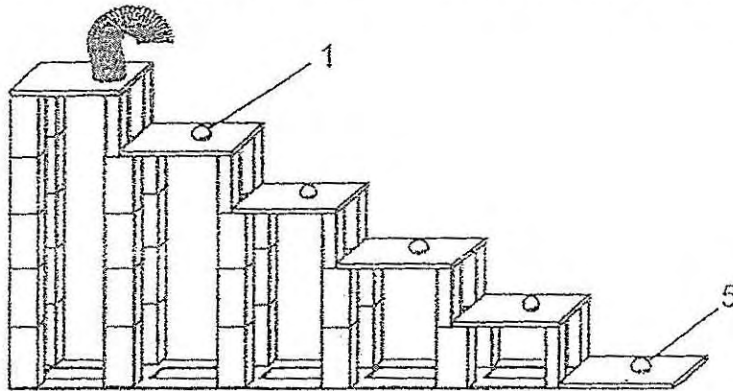

Which of the following forces are acting on the toy as it moves towards position 5?

- A Frictional force
- B Magnetic force
- C Gravitational force
- D Elastic spring force

- (1) A and C only
- (2) B and D only
- (3) A, C and D only
- (4) B, C and D only



27. Sining shone a laser pointer at a mirror as shown in the diagrams below. Which diagram correctly shows the path of a ray of light from the laser pointer? (2)

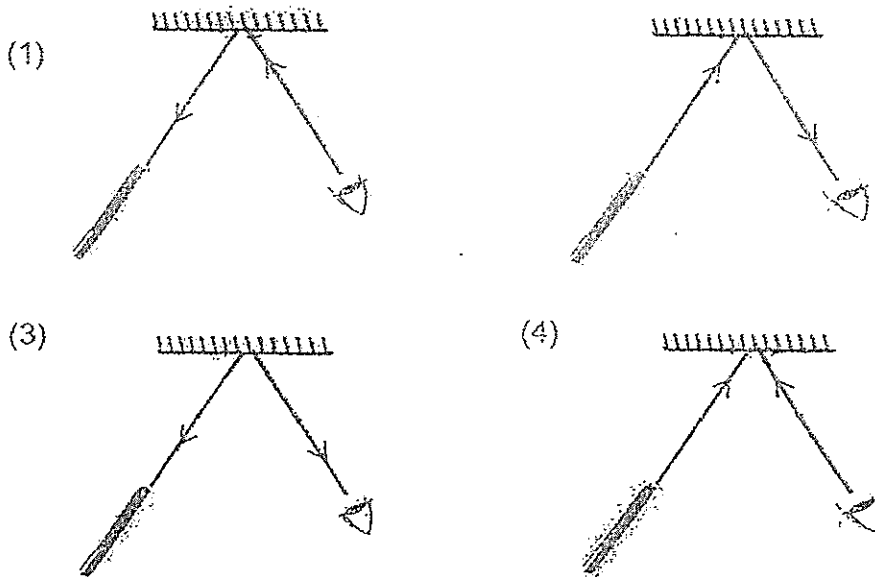

28. Zachary wanted to investigate which material was best at reflecting light. He set up his experiment in a dark room as shown below.

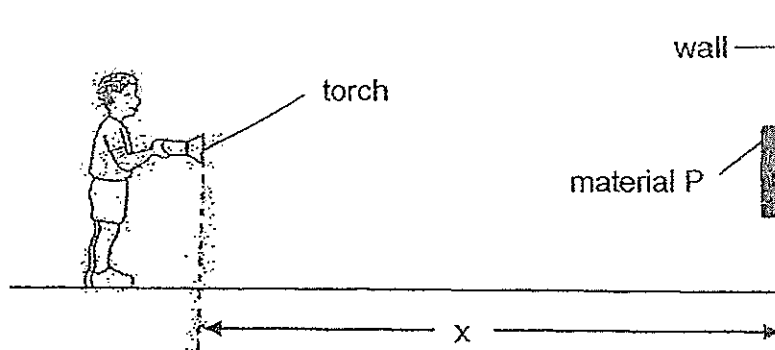

Zachary shone a lighted torch onto the wall and walked towards it. When he could clearly see material P hung on the wall, he stopped and measured the distance  $x$ . He repeated the experiment with materials Q, R and S each time. His results were shown below.

Material	P	Q	R	S
$x$ (cm)	190	330	250	280

Based on Zachary's results, which is the best material to be used to make a safety vest for cyclists to wear at night?

- (1) P  
 (2) Q  
 (3) R  
 (4) S

29. Liam set up the experiment as shown below.

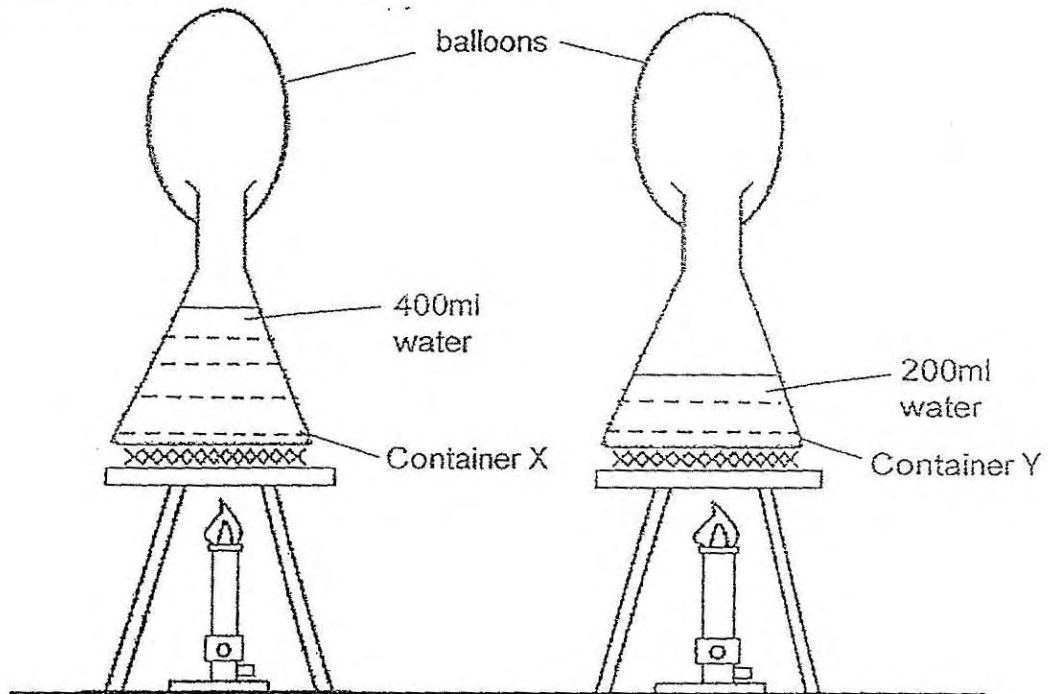

He noticed that the balloons on both set-ups took the same amount of time to be inflated to the same size.

Which of the following are possible reasons for Liam's observation?

- A Water in Container X is cooler than Container Y.
- B Container X conducts heat better than Container Y.
- C Container X is heated by a stronger flame than container Y.

- (1) C only
- (2) A and C only
- (3) B and C only
- (4) A, B and C

30. The diagram below shows a lamp placed at the same distance from two identical glass containers A and B. Container A is covered with a piece of woollen material while container B is covered with a clear plastic sheet.

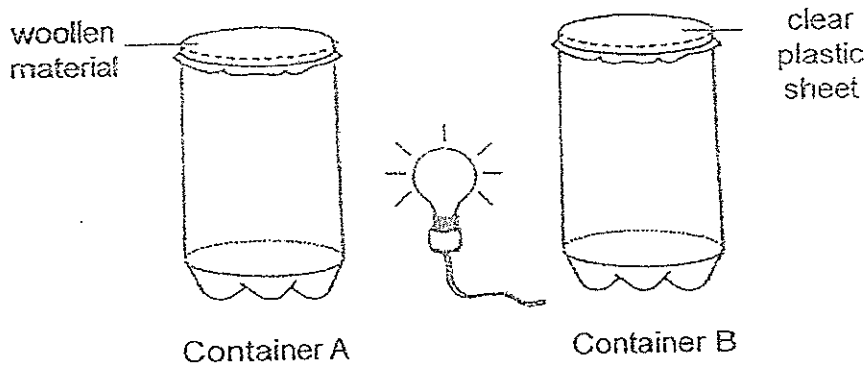

The temperature measured in both containers are recorded as shown in graphs ~~A and B~~ below.

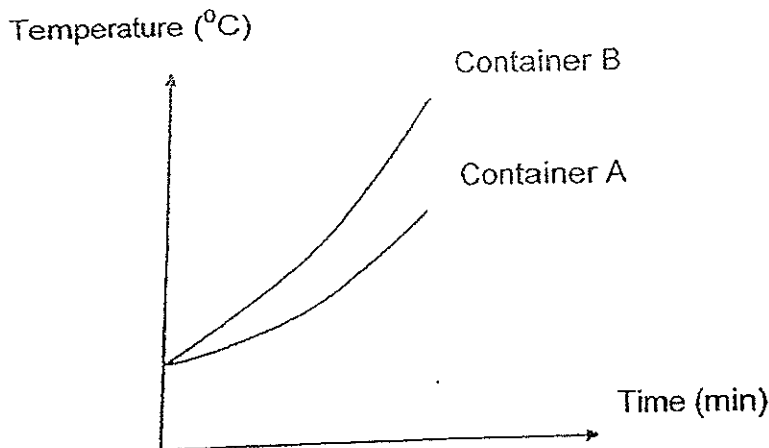

Which one of the following statements correctly explains the results as shown in the graph?

- (1) More heat is trapped in container B as plastic is a poorer conductor of heat than wool.
- (2) More heat is trapped in container A as wool is a poorer conductor of heat than plastic.
- (3) Less heat is trapped in container B as plastic is a better conductor of heat than wool.
- (4) Less heat is trapped in container A as wool is a better conductor of heat than plastic.



NANYANG PRIMARY SCHOOL

PRIMARY 6 SCIENCE

SEMESTRAL ASSESSMENT 1  
2014

**BOOKLET B**

Date : 8 May 2014

Duration : 1 h 45 min

Name : \_\_\_\_\_ (    )

Class: Primary 6 (    )

Marks Scored:

Booklet A:		60
Booklet B :		40
Total :		100

Any query on marks awarded should be raised by 20<sup>th</sup> May 2014. We seek your understanding in this matter as any delay in the confirmation of marks will lead to delays in the generation of results.

Parent's signature: .....

**DO NOT OPEN THIS BOOKLET UNTIL YOU ARE TOLD TO DO SO.  
FOLLOW ALL INSTRUCTIONS CAREFULLY.**

**Booklet B consists of 15 printed pages including this cover page.**

**Section B (40 marks)**

Write your answers to questions 31 to 44 in the spaces provided.

31. Michelle was asked by her teacher to carry out the following experiment using two of the set-ups as the one shown below.

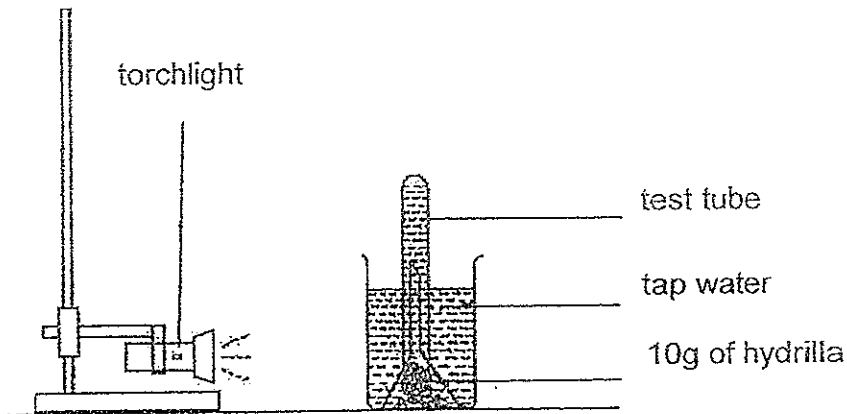

She carried out the following steps to conduct her experiment.

Step 1	Place a torchlight 30 cm away from each set-up
Step 2	Shine a torchlight that gives out red light at one of the set-ups. Measure the height of the gas column in the test-tube after two hours.
Step 3	Shine a torchlight that gives out blue light at the other set-up. Measure the height of the gas column in the test-tube after two hours.

- (a) State the aim of Michelle's experiment. [1]

---



---

- (b) Explain why Michelle should conduct her experiment in a darkened room. [1]

---



---

32. The pie charts below show the percentage of animals in two seashore communities.

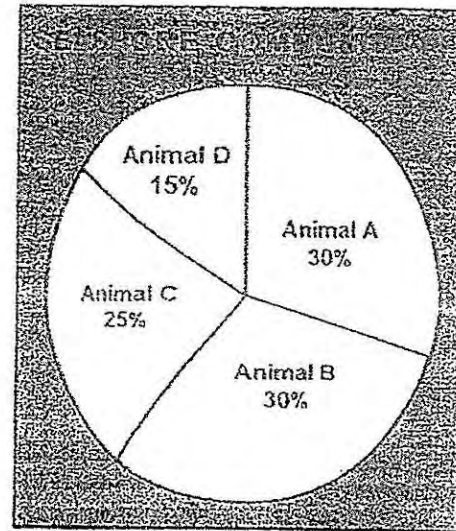
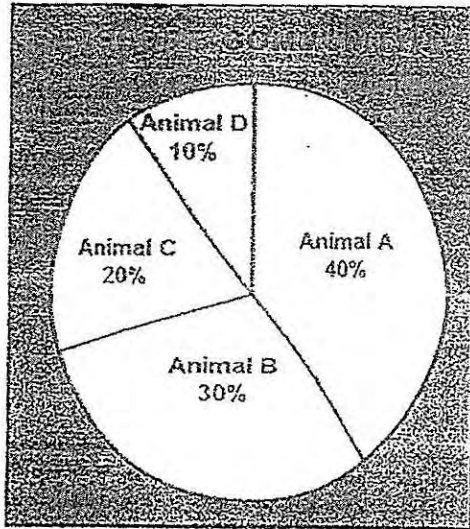

Study the statements in the table below carefully and use a tick (✓) to indicate whether they are "True", "False" or "Not possible to tell". [1]

(a)

Statements	True	False	Not possible to tell
(i) There is a higher percentage of Animal C in community Y than in community X.			
(ii) The number of animals in community X is the same as in community Y.			

(b) The following observations are made of the animals in these communities:

- Animal A is eaten by animals B and C.
- Animal C is the prey of animal D and a predator of animal B.
- Animal D eats animal B.

Based on the information above, draw arrows to complete the food web in the box below. [2]

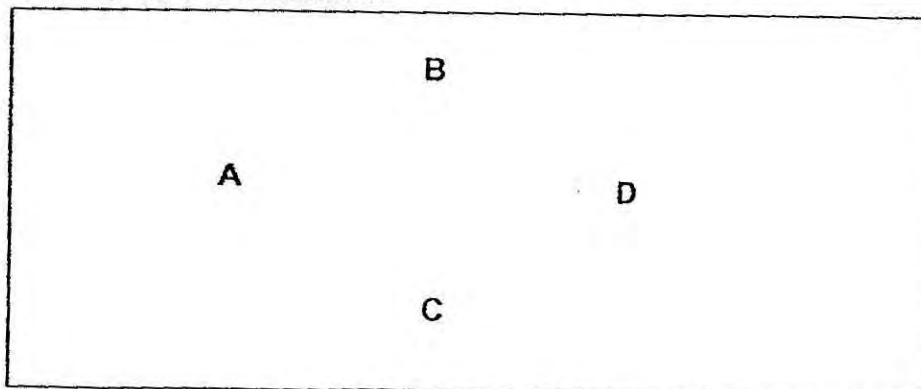

33. Study the food web below

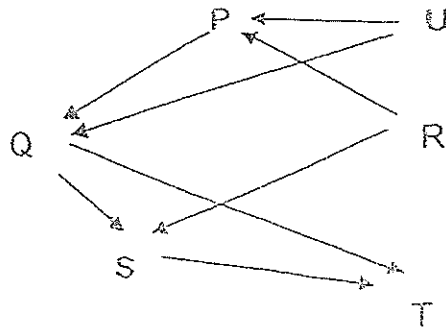

(a) Identify the food producer(s) in this community. [1]

---

(b) Which organism(s) is/are both a prey and a predator? [1]

---

(c) Explain the food relationship between organisms Q, R, S and T. [1]

---



---

(d) State what happens initially when population of organism S is removed from the food web.

---



---

34. The machine shown below is able to produce water from the air that passes through it.

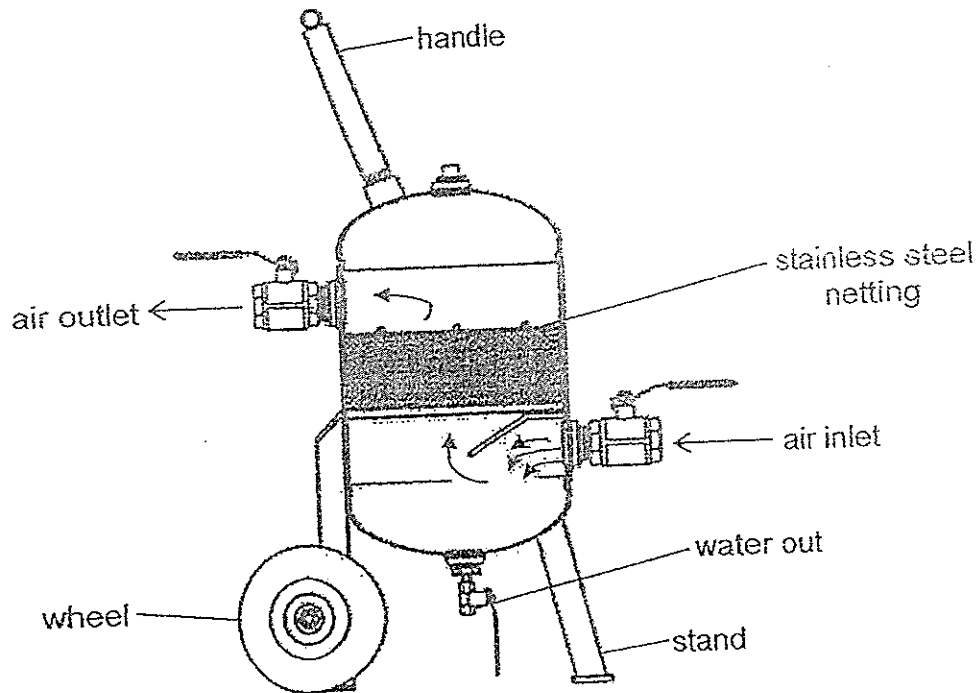

Air enters through the inlet and passes through a sheet of cold stainless steel netting before leaving through the outlet. This netting is cooled by a special liquid. When the machine is switched on, the temperature of the netting is kept at  $10^{\circ}\text{C}$ .

- (a) Explain how this machine is able to produce water from the air that passes through it. [2]

---

---

---

---

- (b) One way to collect more water using this machine is to pass more air through the inlet. Suggest **two other changes** to the machine that would enable it to collect more water over a fixed period of time. [2]

(i) \_\_\_\_\_

(ii) \_\_\_\_\_



35. Diana wanted to find out the size of flowers which most butterflies prefer. She made some model flowers using cards of different sizes. She put 10 drops of sweetened water in the centre of each flower. The model flowers were then left in an open field.

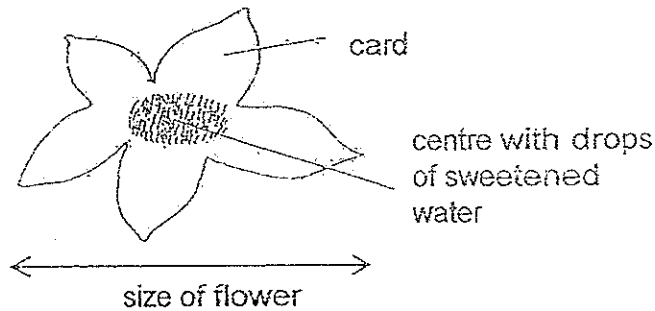

Diana then counted the number of butterflies that visited the model flowers over 1 hour. The results were recorded in the table below.

Size of flower	Number of butterflies
5 cm	7
10 cm	14
15 cm	20

- (a) Based on Diana's result, what is the relationship between the size of the flowers and the number of the butterflies visiting them? [1]

---



---

- (b) Ming Hui wanted to find out the relationship between the colour of the flowers and the number of butterflies visiting the flowers. She decided to use a few 10-cm flowers from Diana's experiment to carry out her own experiment.

In the table below, put a (✓) to indicate the variable(s) that she has to keep the same to ensure a fair test. [1]

	The colour of the flowers
	The duration of the experiment
	The number of drops of sweetened water

36. Ding Li wanted to find out the rate of germination of some seeds. He planted 25 dried seeds on a piece of cotton wool and watered them daily. He recorded the following information over a period of 6 days.

Day	Number of seeds germinated
1	0
2	1
3	3
4	6
5	7
6	8

- (a) Suggest a possible reason why no seeds germinated on the first day. [1]

---



---

Ding Li wanted to find out whether seeds need warmth to germinate. She used two opaque jars, P and Q, and filled them with equal amount of moist garden soil. She placed six seeds in each jar.

- (b) State a suitable location where Ding Li should place each container. [1]

Container	Location
P	<hr/>
Q	<hr/>

- (c) Based on your answer in (b), what observation would enable her to conclude that seeds need warmth to germinate? [1]

---



---

37. The diagram below shows a man with an artificial heart. This artificial heart is connected to an electronic monitor which is strapped around his waist. This electronic monitor indicates his heart rate.

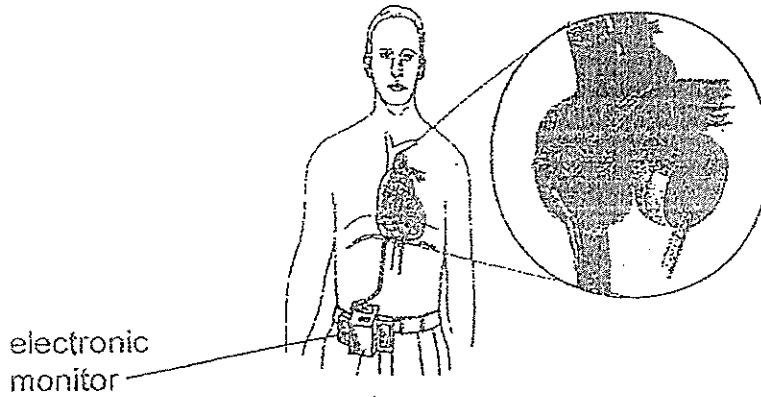

The table below shows the measurement indicated in the electronic monitor when the man carries out different activities.

	Reading	Jogging
Heart rate (beats per min)	70	110

(a) Explain what this information indicates about his heart rate when he jogs and the reason that causes this change in his heart rate. [2]

---



---



---



---

(b) Label and complete the line graph below to show the breathing rate of the man when he jogs for 20 minutes at constant speed before cooling down for 10 minutes. [1]

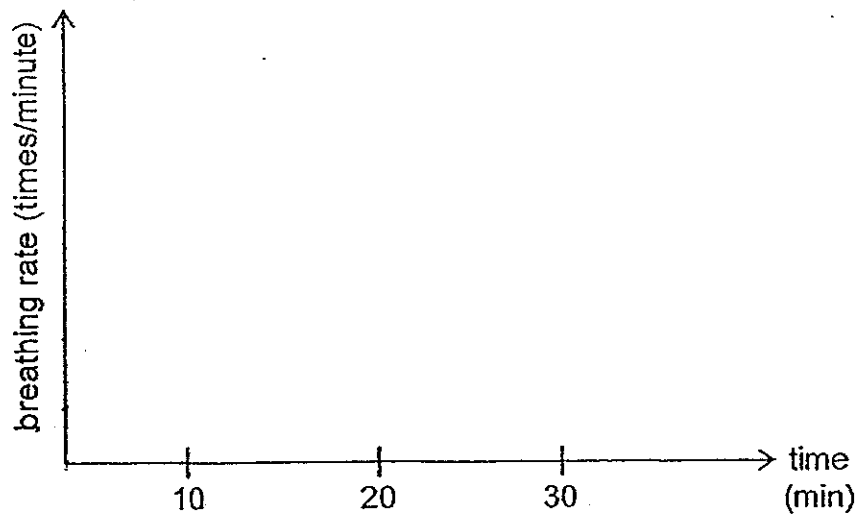

38. Study the diagram of a tree below.

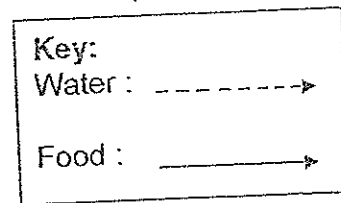
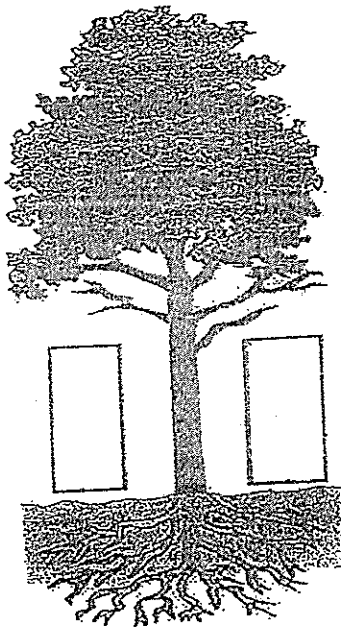

(a) In the empty boxes above, draw and label arrows to show the direction of the flow of water and food using the key provided. [1]

(b) Explain how the tree loses water. [1]

---



---

39. The diagram below shows a plant cell.

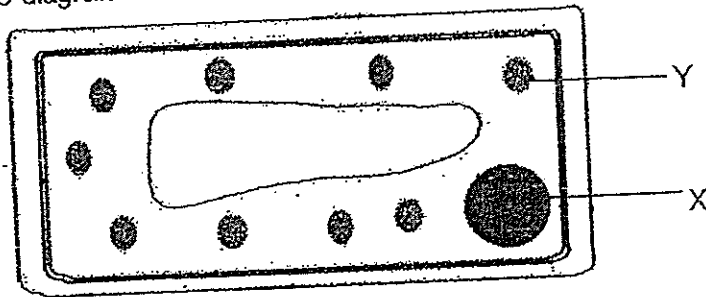

(a) Identify and state the function of Part X. [1]

---



---

(b) What happens to the plant when all of parts Y are removed? [1]

---



---

40. The diagram below shows parts of the human digestive system.

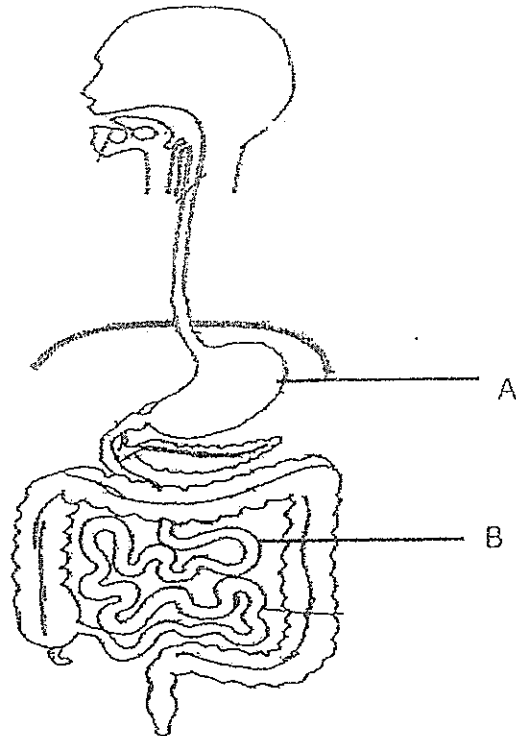

- (a) Mark and label parts, X and Y, clearly on the diagram to show where each of the following processes takes place: [1]
- i) X, where digestion starts
  - ii) Y, where digestion ends
- (b) A liquid is present in the organs labelled A and B above. Explain how this liquid helps in the digestion of food. [1]

---

---

41. The diagram below shows a manual compost mixer. It is used by farmers to mix soil and compost together before he uses it in his farm

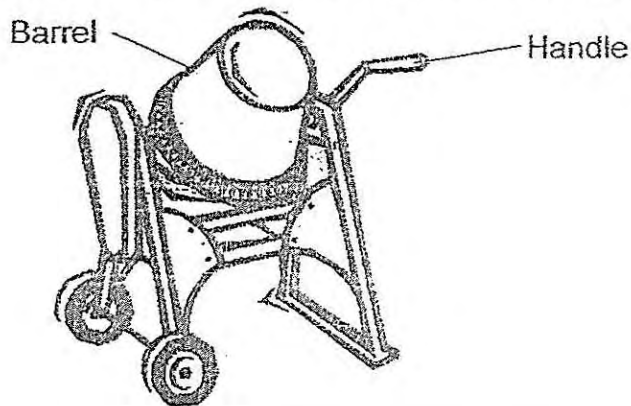

The farmer will pour the soil and compost into the barrel and turn the handle to mix them together.

- (a) What energy does the farmer possess before he turns the handle? [1]

---

- (b) State the correct energy conversion that takes place when the farmer turns the handle. [2]

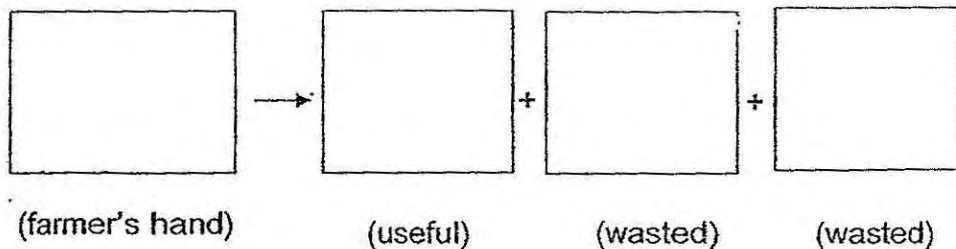

The compost contains decomposers and dead organisms. The farmer accidentally dropped a lighted match on a pile of compost. The compost then **burst** into flame.

- (c) Based on his observation, what form of energy does the compost possess before it was lit up? [1]

---

42. The diagram below shows a toy. It is made up of a C-shaped section with a globe floating in the middle.

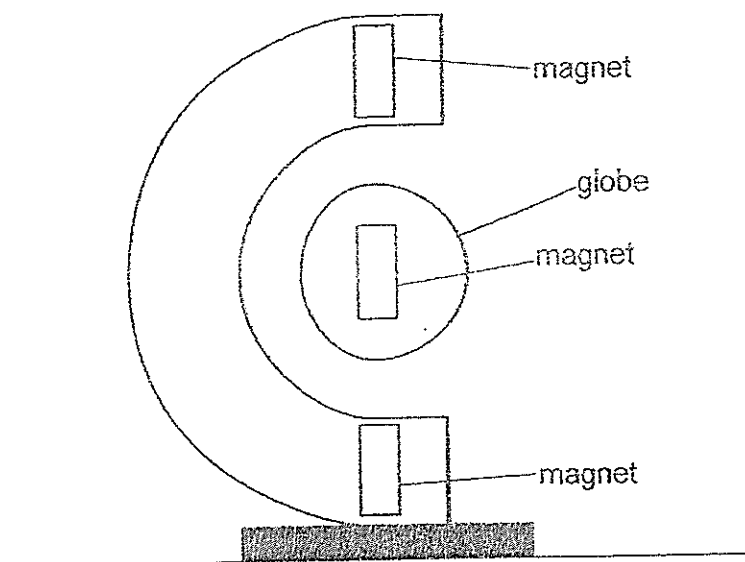

The globe is able to float between the C-shaped section.

- (a) Name the two forces which are acting on the globe. [1]

---

---

- (b) In the diagram above, label the poles of the magnets which enable the globe to float. [1]

- (c) Describe what would likely happen if a heavier globe is used. [1]

---

---

43. Emily set up an experiment in a dark room as shown below using similar rods made of different materials.

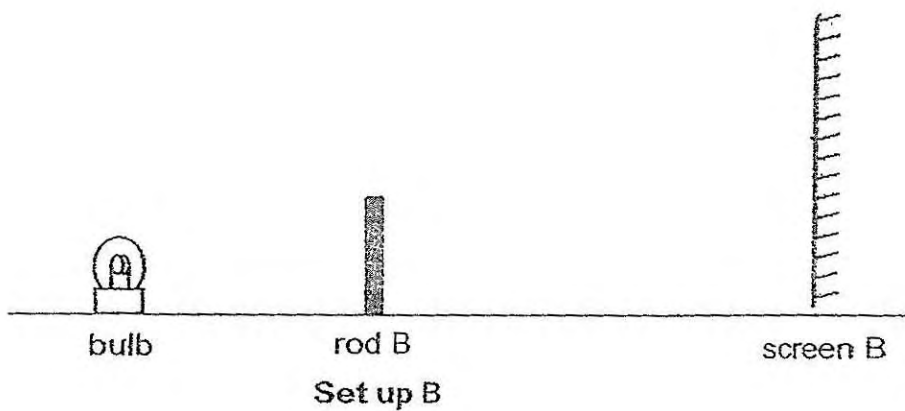
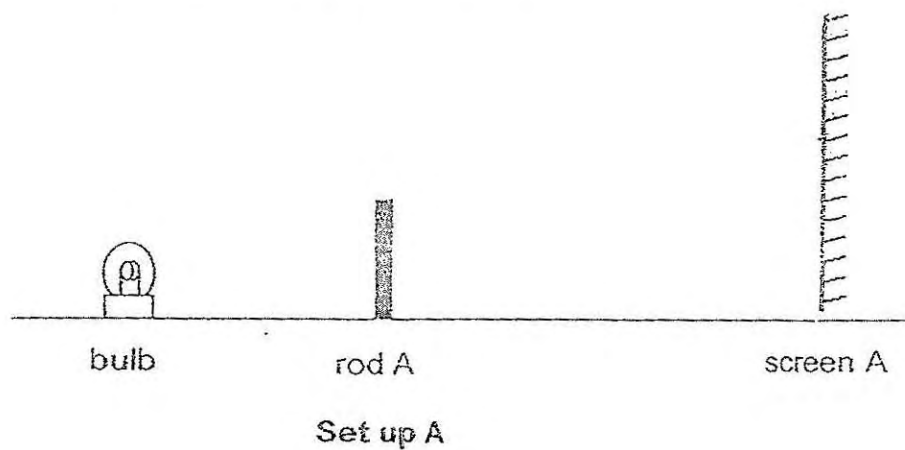

A dark shadow was observed on screen B but a very faint shadow was observed on screen A.

- (a) Give an explanation to the above observation. [2]

---

---

---

---



Emily then used a wooden rod and set up another experiment as shown below. She switched on the light and placed the rod at position P. She then measured the length of the shadow formed.

- (b) In the diagram below, mark the position of the shadow on the ground with an 'X'. [1]

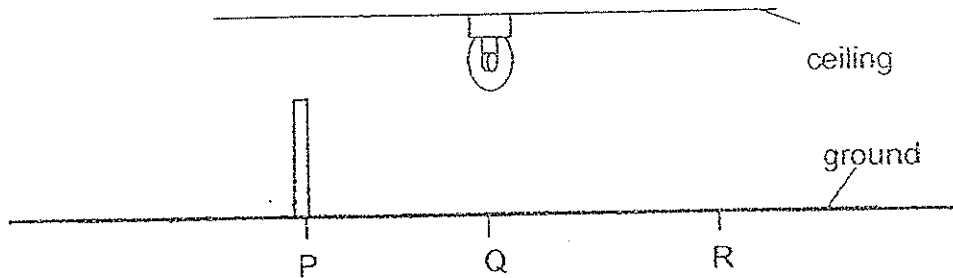

The graph below shows how the length of the shadow of the wooden rod changed when Emily placed it at the three different positions.

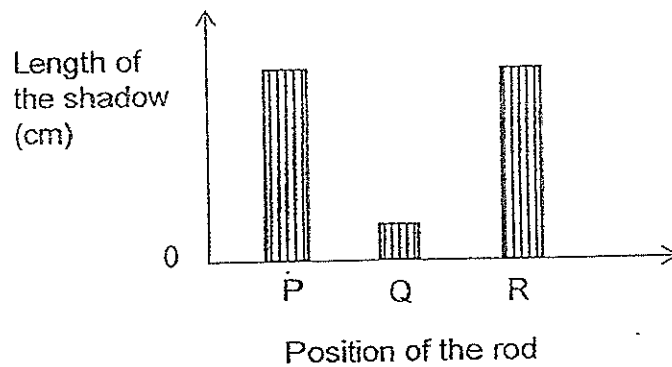

- (c) Based on the graph above, describe the change in the length of the shadow of the wooden rod when it was placed at the different positions. [1]

---



---

44. An electric iron is used to remove creases in a shirt as shown below.

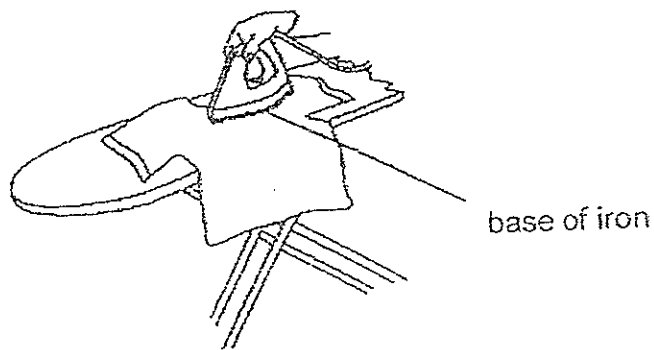

The base of the electric iron is made of a strong and hard metal.

- (a) State another property of a metal that makes it suitable for use as the base of an electric iron. [1]

---

---

Keith used two identical irons made of metal plates of the same material but with different surfaces as shown below.

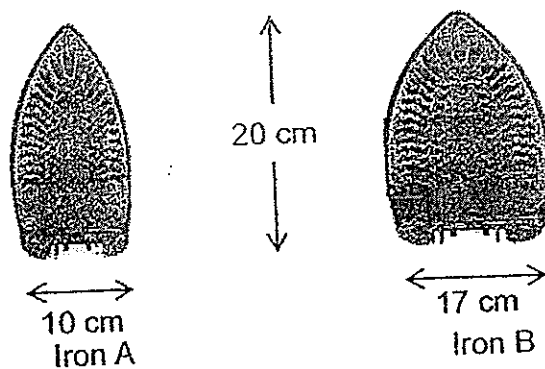

- (b) Which iron, A or B, would allow Keith to iron his clothes in a shorter time? Give a reason for your answer. [1]

---

---

~ End of Paper ~

# ANSWER SHEET

**EXAM PAPER 2014**  
**SCHOOL : NANYANG**  
**PRIMARY : P6**  
**SUBJECT : SCIENCE**  
**TERM : SA1**

Q1	Q2	Q3	Q4	Q5	Q6	Q7	Q8	Q9	Q10	Q11	Q12	Q13	Q14	Q15	Q16	Q17
3	3	3	2	2	1	2	1	4	4	3	1	3	1	4	3	4

Q18	Q19	Q20	Q21	Q22	Q23	Q24	Q25	Q26	Q27	Q28	Q29	Q30
3	4	1	3	2	3	4	2	3	2	2	3	1

31)a) To find out how the rate of photosynthesis of hydrilla is affected by red or blue light.

b) To ensure that the results of the experiment is caused only by the coloured lights.

32)a) i) T ii) Not

b)

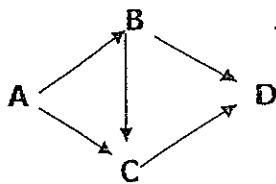

33)a) V and R

b) S and Q

c) R is eaten by S and Q is also eaten by S. T eats both S and Q.

d) U, R and Q will increase in population while T and P decrease in population.

34)a)The water vapour in the air touches the cooler steel netting and condenses to form tiny droplets of water.

- b)i)Increase the surface area of the netting.
- ii)Make the netting colder.

35)a)The bigger the size of the flowers the more the number of butterflies.

- b)The duration of the experiment
- The number of drops of sweetened water

36)a)The seeds need time to absorb water.

- b)P: Under the sun.
- Q: fridge
- c)More seeds will germinate in P than Q.

37)a)The heart rate increases to supply more oxygen and digested food to all parts of the body and remove more carbon dioxide from all parts of the body.

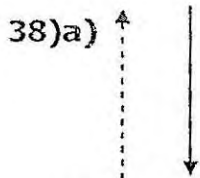
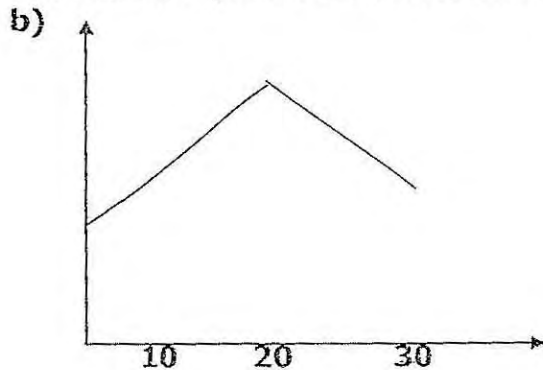

- b)It loses water through the stomata.

39)a)Nucleus. It controls all the activities in the cell.

- b)The plant will not be able to photosynthesise and cannot make food hence the plant will die.

40)a)i)ii)

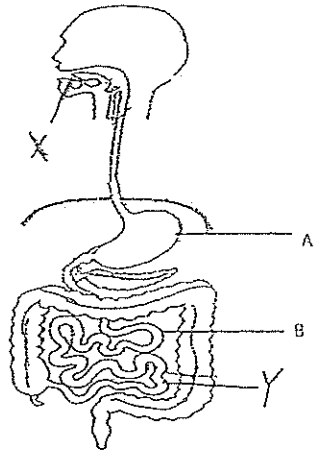

b)The liquid breaker down the food into simpler substances.

41)a)Chemical potential energy.

b)Kinetic energy → Kinetic energy + Heat energy + Sound energy

c)Chemical potential energy.

42)a)Magnetic force and gravitational force.

b)

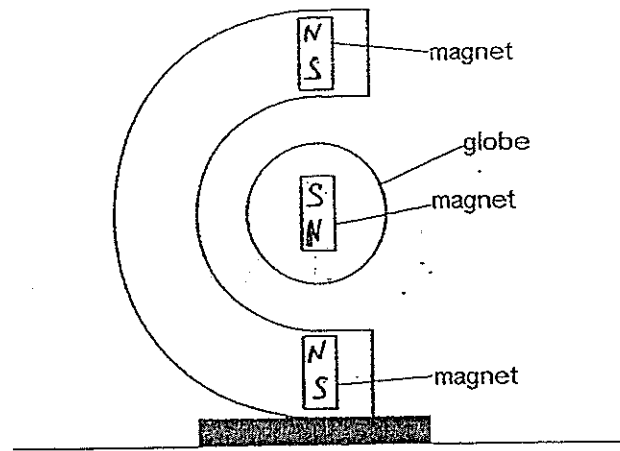

c)It will not be floating any more.

43)a) Rod A is a translucent object and Rod B is an opaque object.

b)b)



c)The length of the shadow at P and R is the same while it is shorter at Q.

44)a)Metal is a good conductor of heat.

b)Iron B. As its surface area is bigger, so it can iron his clothes faster.