



Anglo-Chinese School (Primary)

MID-YEAR EXAMINATION 2014
SCIENCE
PRIMARY SIX
BOOKLET A

Name: _____ ()

Class: Primary 6 _____

Date: 8 May 2014

Duration of paper: 1 h 45 min

Parent's/Guardian's Signature

INSTRUCTIONS TO CANDIDATES

1. This questions paper consists of 20 printed pages including this cover page.
2. Do not turn over this page until you are told to do so.
3. Follow all instructions carefully.
4. Answer all questions.
5. Shade your answer on the Optical Answer Sheet (OAS) Provided.

For each question from 1 to 30, four options are given. One of them is the correct answer. Make your choice and shade the correct oval (1, 2, 3 or 4) on the Optical Answer Sheet. (60 marks)

- 1 The classification chart below shows how four insects A, B, C and D are classified.

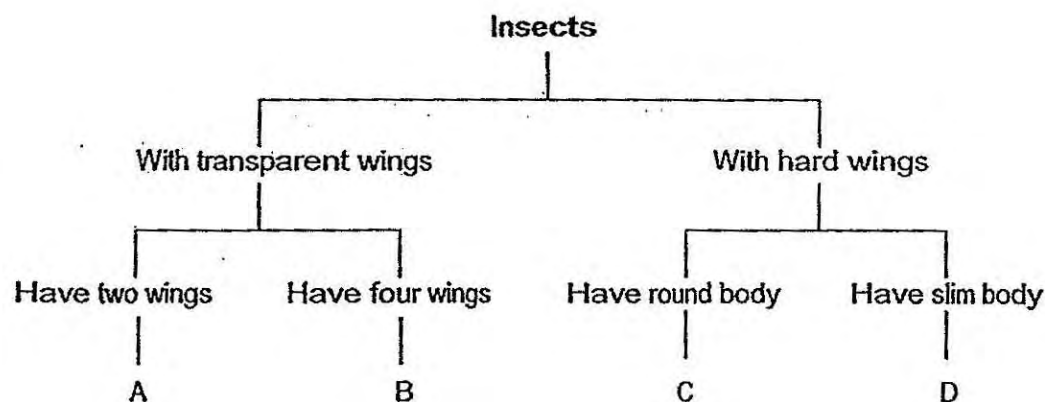

Insects A, B, C and D are not classified according to the _____.

- (1) Body shape
 - (2) Way they fly
 - (3) Type of wings
 - (4) Number of wings
- 2 Tom wanted to test the strength of four different strings, W, X, Y and Z. He hung weights at the end of each string until the string broke. The table below shows the result.

String	Mass at which the string broke (g)
W	500
X	450
Y	420
Z	510

Which variable must he keep the same in order to conduct a fair test?

- (1) Length of each string
- (2) Strength of each string
- (3) Mass at which each string broke
- (4) Number of weights hung on each string

- 3 The picture below shows the human digestive system.

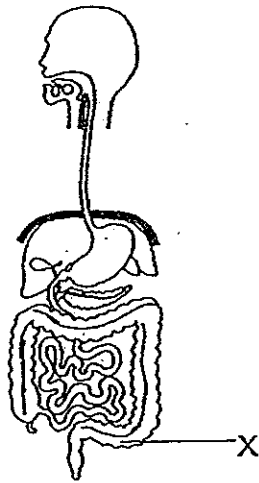

What substance is mostly found at part X?

- (1) Water
 - (2) Digested food
 - (3) Digestive juices
 - (4) Undigested food
- 4 The picture below shows the human respiratory system.

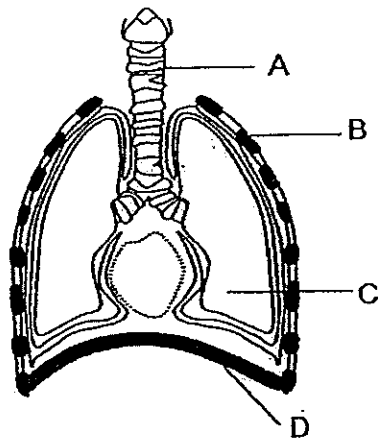

Which part(s) of the system when contract(s) cause(s) air to be pushed out of the system?

- (1) A only
- (2) D only
- (3) A and B only
- (4) B, C and D only

- 5 Study the diagram of a flower as shown below.

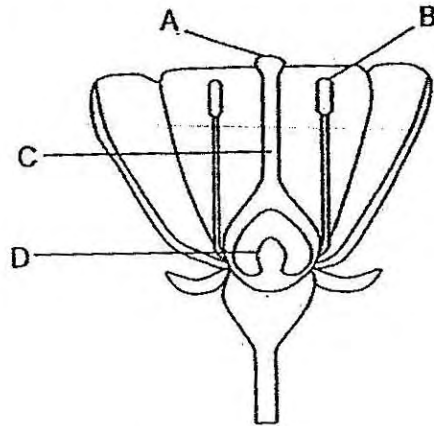

In which part, A, B, C or D, does fertilization take place?

- (1) A
 (2) B
 (3) C
 (4) D
- 6 Danny counted the number of certain animals found in a pond. He recorded the information in the table below.

Number of				
A		B		C
Larvae	Adults	Eggs	Adults	Adults
20	7	50	18	5

Based on the table, which one of the following statements is most probably correct?

- (1) The number of animal C is increasing.
 (2) The number of adults of animal C is the least.
 (3) The population size of animal A is more than B.
 (4) The community is made up of only animals A and B.

- 7 A metal bar was hung freely by a string. A magnet was then placed near the metal bar which caused the metal bar to swing as shown below.

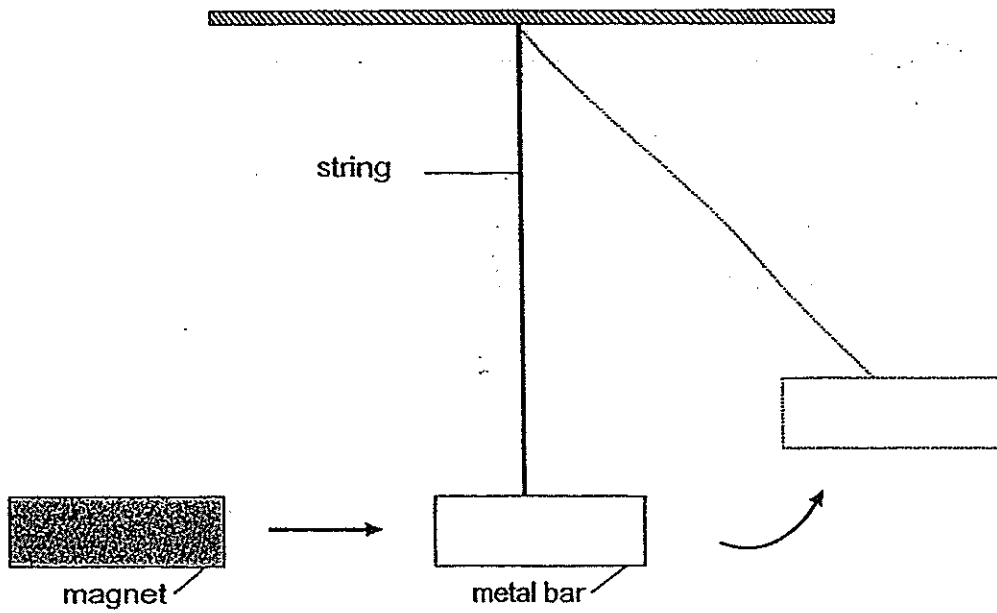

Based on the observation, which one of the following is changed by the magnetic force?

- (1) The size of an object
- (2) The mass of an object
- (3) The shape of an object
- (4) The position of an object

- 8 A toy car was allowed to roll down a ramp and hit an object A at the end of the ramp. The distance that object A moved was measured as shown below.

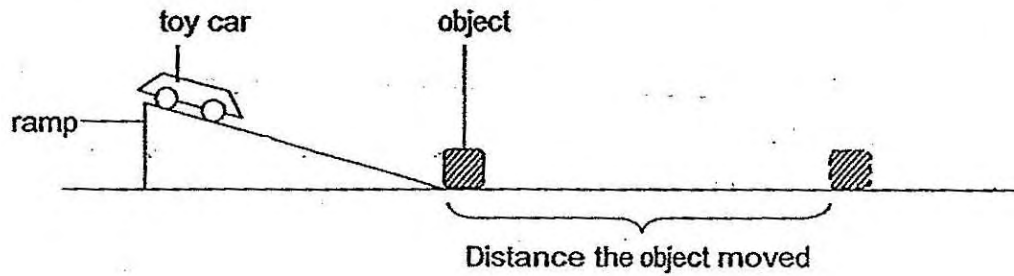

The experiment was repeated using three other objects B, C and D. The results were recorded in the graph below.

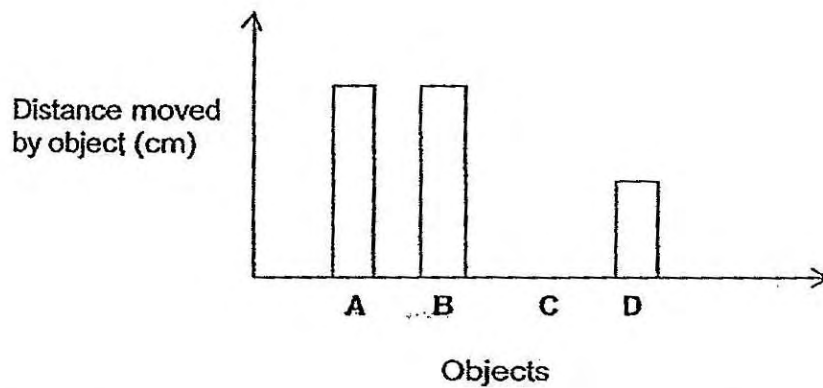

Which object(s) exerted a force equal and opposite to the force that the toy car exerted?

- (1) C only
- (2) D only
- (3) A and B only
- (4) A, B, C and D

- 9 The classification chart below shows how forces can exist between objects.

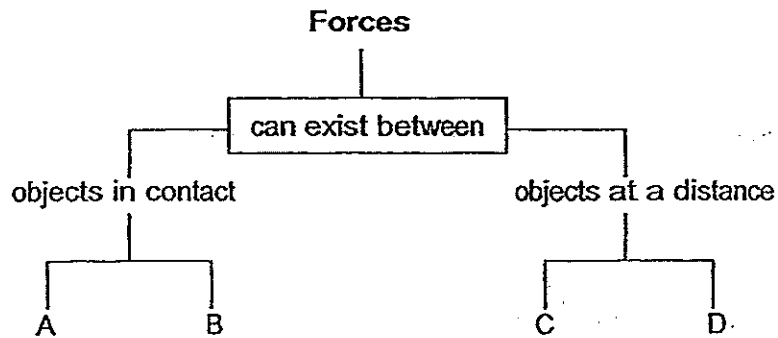

Which of the following correctly identify the types of forces represented by A, B, C and D?

	A	B	C	D
(1)	Magnetic	Gravitational	Frictional	Elastic spring
(2)	Magnetic	Frictional	Gravitational	Elastic spring
(3)	Gravitational	Elastic spring	Magnetic	Frictional
(4)	Frictional	Elastic spring	Magnetic	Gravitational

- 10 The diagram below shows an electromagnet.

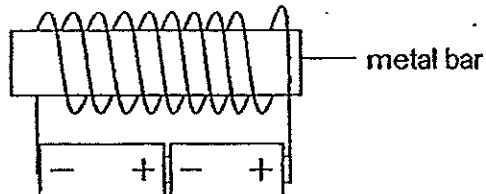

Which action will enable the electromagnet to attract a magnetic object from a greater distance?

- (1) Heat the electromagnet
- (2) Change the wire to a thinner wire
- (3) Decrease the number of batteries
- (4) Increase the number of coils round the metal bar

- 11 A load was hung from a spring A as shown below and the increase in length was measured and recorded. The experiment was repeated using the same load but different springs, B, C and D.

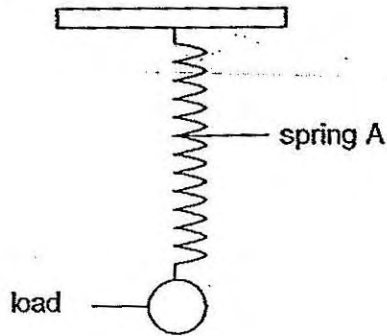

The graphs below show the results of the experiment.

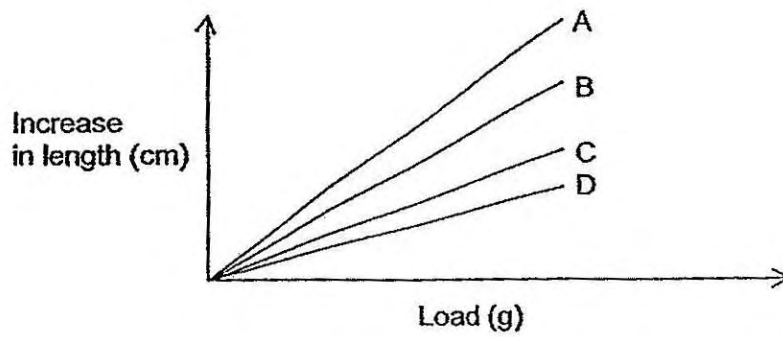

Which spring, A, B, C or D stretched most easily?

- (1) A
- (2) B
- (3) C
- (4) D

12. Ben kicked a ball as shown and the ball flew to a height of five metres.



He kicked the ball again but this time the ball flew to a height of three metres.

Which one of the following could explain why the ball did not fly as high as the first time?

- (1) The ball lost some weight.
 - (2) The amount of friction increased.
 - (3) The kinetic energy of the ball was less than before.
 - (4) The kinetic energy of the ball was not converted to potential energy.
- 13 An arrow was shot and it flew along the path as shown below.

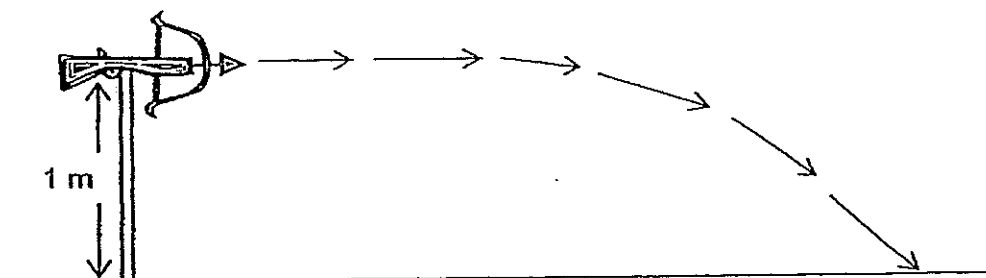

Which one of the following statements about the arrow moving along the path is true?

- (1) Gravity is constant throughout the path.
- (2) Gravity is the least when the arrow landed.
- (3) The speed of the arrow is the fastest when it landed.
- (4) The speed of the arrow is constant throughout the path.

- 14 A magnet was placed on a slope with a rubber surface and it remained stationary as shown below.



Which force caused the magnet to remain stationary on the slope?

- (1) Frictional force
 - (2) Magnetic force
 - (3) Gravitational force
 - (4) Elastic spring force
- 15 Weiyi wanted to test the flexibility of some fishing rods. He hung a load from rod, A, B, C and D as shown below. The strings used were similar and of equal lengths.

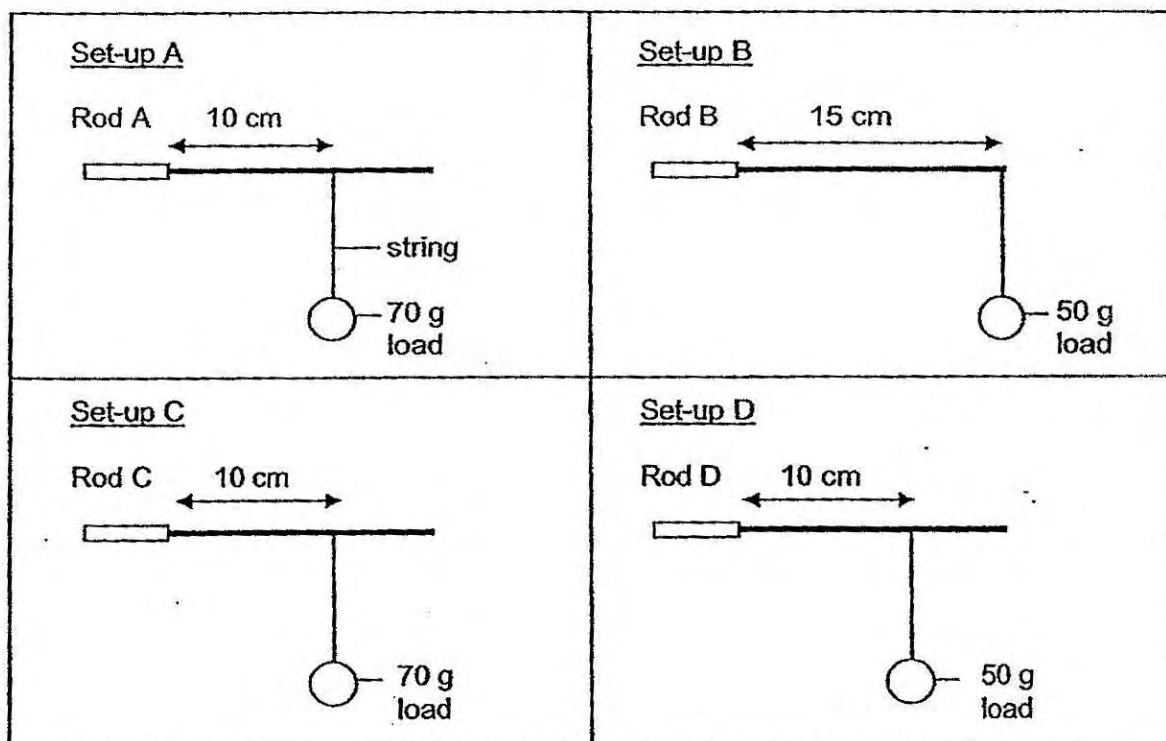

Which two set-ups should he use in order for the test to be fair?

- (1) A and B
- (2) A and C
- (3) B and C
- (4) C and D

- 16 Study the diagrams below. Which one of the following would result in the greatest attraction between the two magnets?

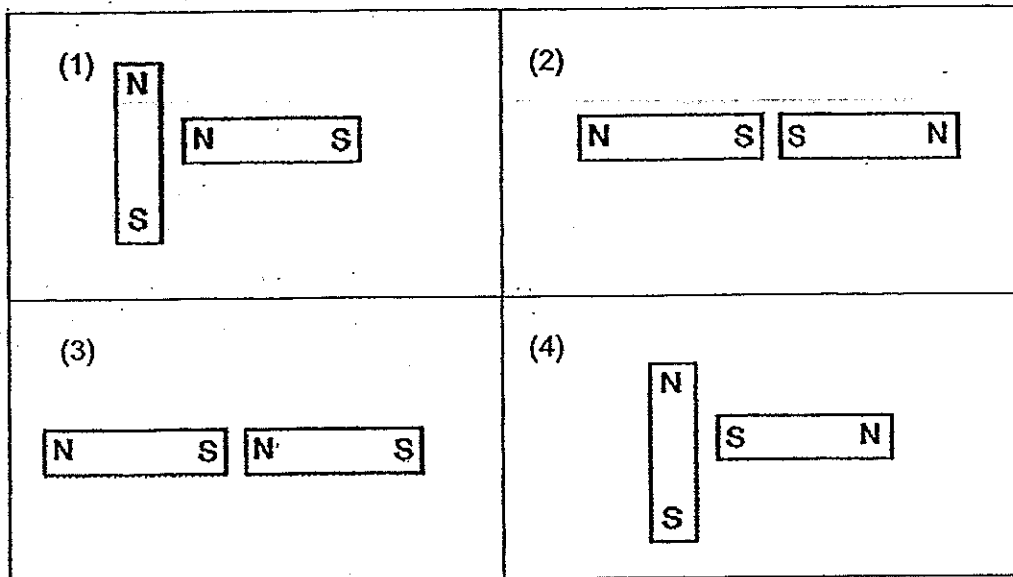

- 17 The picture below shows a battery-powered torch.



Which sequence of energy conversions occurs when the torch is switched on?

- (1) electrical energy \rightarrow light energy \rightarrow chemical potential energy
- (2) electrical energy \rightarrow chemical potential energy \rightarrow light energy
- (3) chemical potential energy \rightarrow light energy \rightarrow electrical energy
- (4) chemical potential energy \rightarrow electrical energy \rightarrow light energy

- 18 A calorie is a unit of energy used to represent the amount of energy in the food that we consume. The graph below shows the average number of calories needed each day by young people.

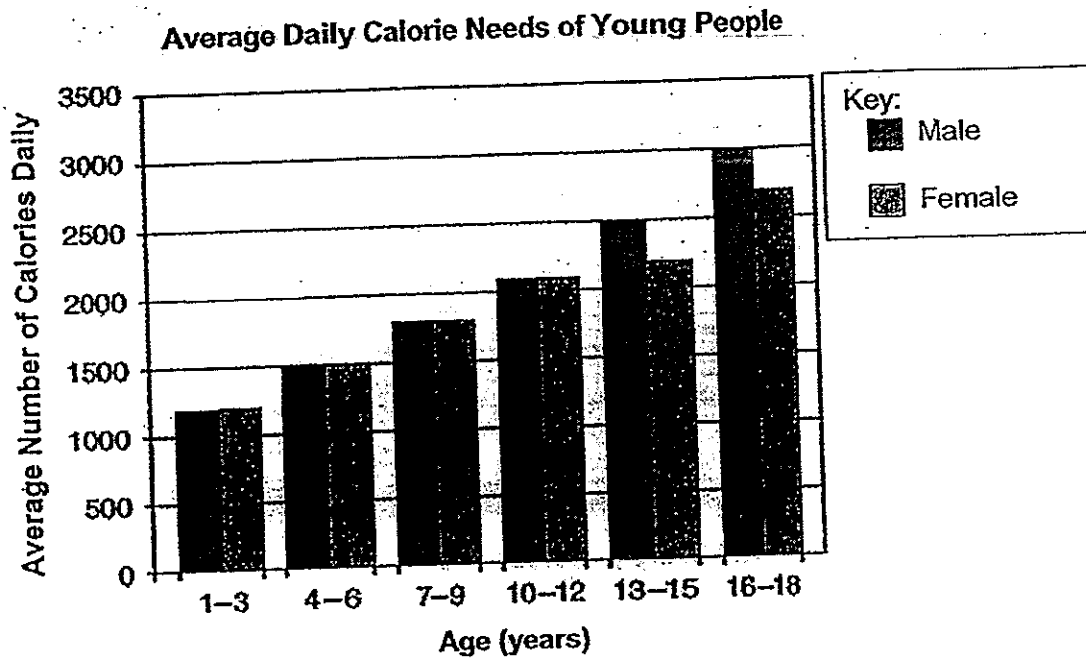

Which one of the following statements is supported by the information from the graph?

- (1) At age 16, a female needs the same amount of calories as a male.
- (2) At age 13, a male needs the same amount of calories as a female.
- (3) An 8-year-old female needs fewer calories than a 5-year-old male.
- (4) An 18-year-old female needs more calories than a 14-year-old female.

- 19 The diagram below shows a rock being suspended above a container filled with water up to the spout.

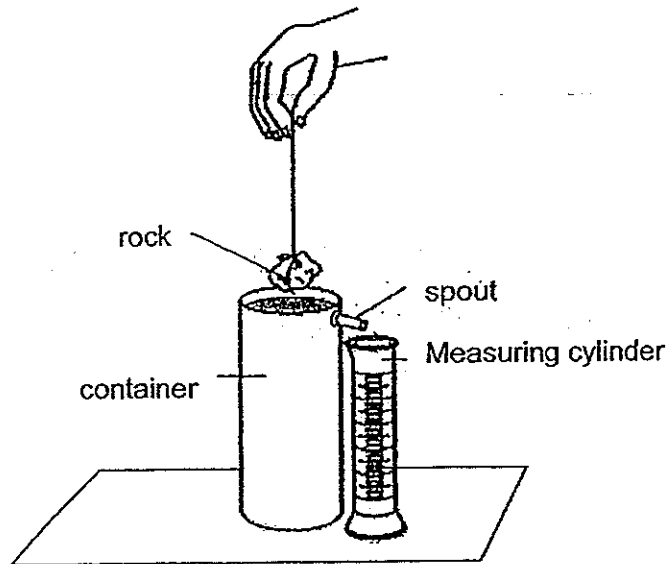

When the rock was lowered gently into the container filled with water, water came out of the spout and was collected by the measuring cylinder. Which property of the rock was determined when it was placed completely in the container?

- (1) Mass
- (2) Volume
- (3) Strength
- (4) Hardness

- 20 The diagram below shows a cyclist travelling down a slope.

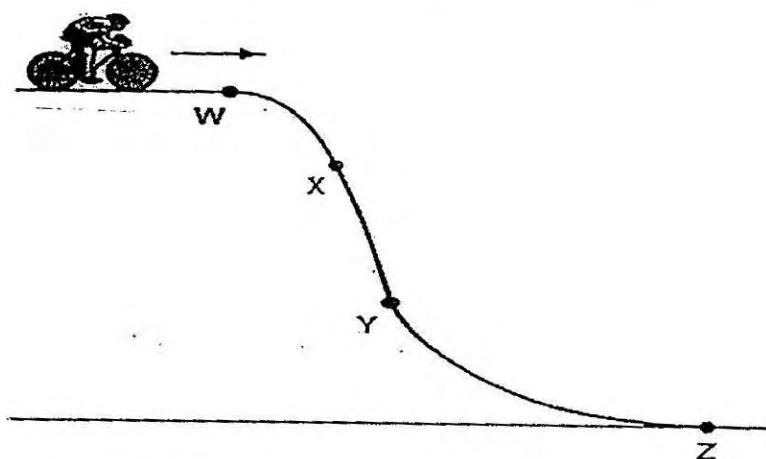

At which position, W, X, Y or Z, does the cyclist have the greatest amount of kinetic energy?

- (1) W
 - (2) X
 - (3) Y
 - (4) Z
- 21 Study the diagram below. Four balls E, F, G and H, each of a different mass, were dropped from the same height into a tray of fine sand.

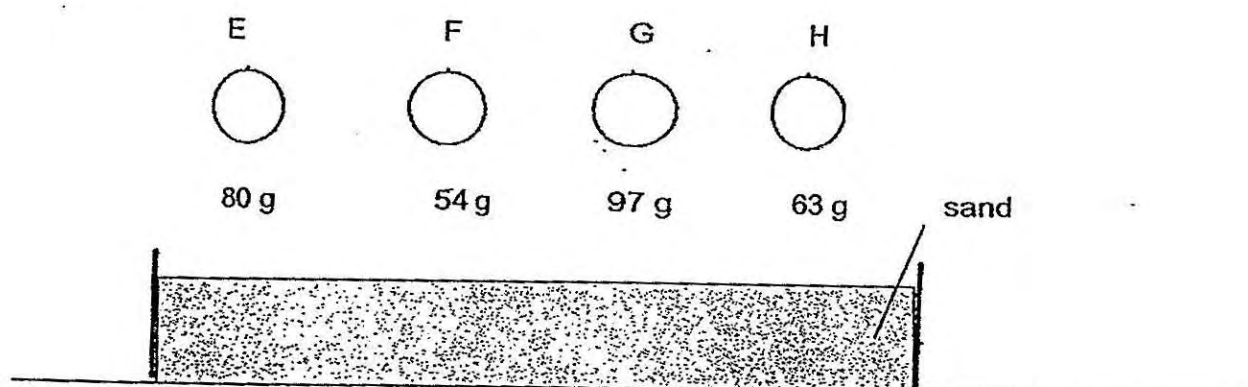

Which ball created the greatest depression when it landed in the sand?

- (1) E
- (2) F
- (3) G
- (4) H

(Go on to the next page)

- 22 Sam placed a ball on a ramp as shown in the diagram below. He gave the ball a push and it rolled down the ramp.

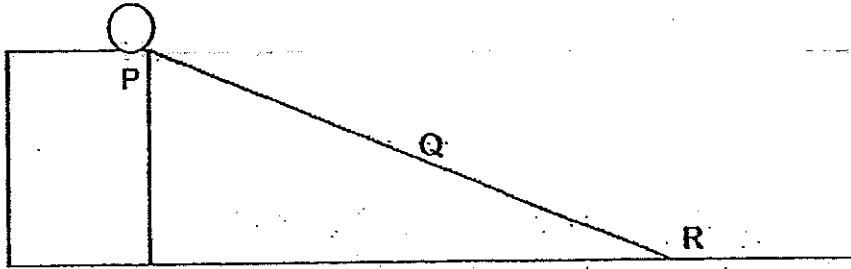

Which one of the graphs below illustrates the change in the amount of kinetic and potential energy of the ball as it rolled down the ramp?

Key:
 _____ Potential energy
 _____ Kinetic energy

<p>(1)</p> <p>Amount of energy (units)</p> <p>Position</p>	<p>(2)</p> <p>Amount of energy (units)</p> <p>Position</p>
<p>(3)</p> <p>Amount of energy (units)</p> <p>Position</p>	<p>(4)</p> <p>Amount of energy (units)</p> <p>Position</p>

- 23 John carried out an experiment to find out whether the colour of light affects the rate of photosynthesis.

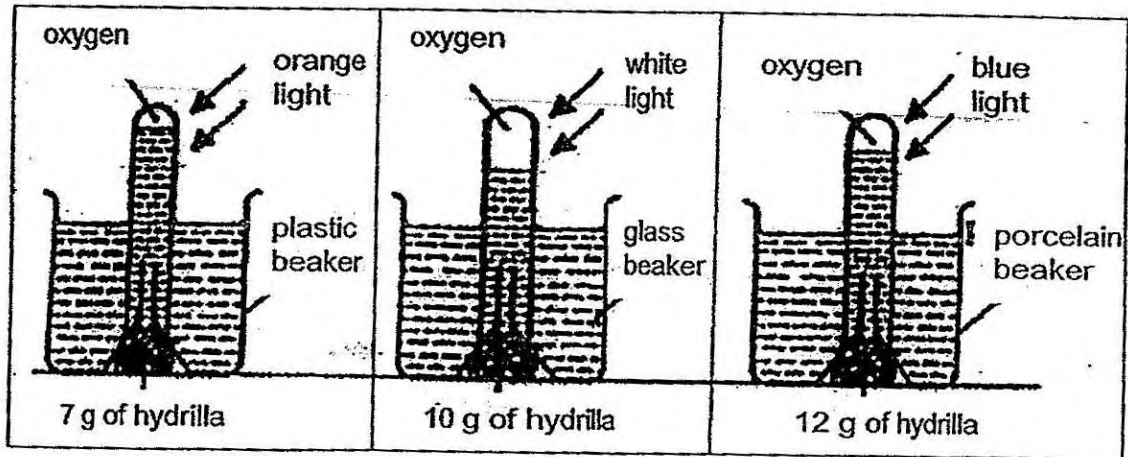

The experiment that he had conducted was not a fair test because

- _____
- A different colours of lights were used
 - B different types of beakers were used
 - C different amount of hydrilla was used
 - D different amount of oxygen was collected
- (1) A and B only
- (2) A and D only
- (3) B and C only
- (4) C and D only

(Go on to the next page)

- 24 Alan is holding a catapult as shown in the picture below. Which form of energy does the catapult possess after it is pulled back?

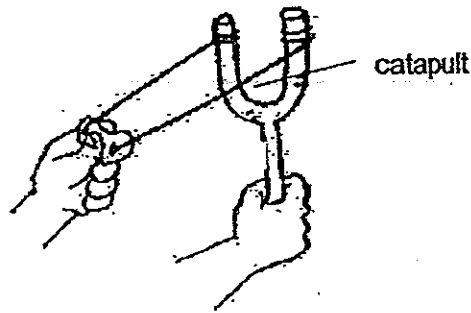

- (1) Light energy
 (2) Kinetic energy
 (3) Elastic potential energy
 (4) Gravitational potential energy
- 25 Alex shone his torch at a tennis ball as shown in the diagram below.

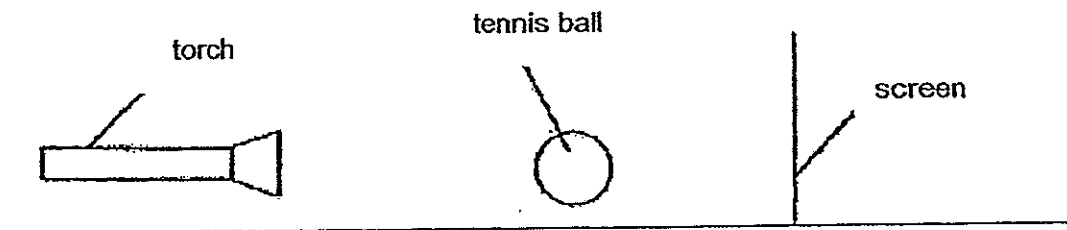

What can he do to get a smaller shadow of the ball on the screen?

- A Rotate the ball.
 B Move the ball closer to the screen.
 C Move the torch further away from the ball.
 D Move the screen further away from the ball.
- (1) A and B only
 (2) B and C only
 (3) B and D only
 (4) C and D only

26 Which one of the following groups of items below consists of only renewable sources of energy?

- (1) Sun and wind
- (2) Wind and petrol
- (3) Coal and waterfall
- (4) Waves and natural gas

27 The diagram below shows how electricity is produced at a power station.

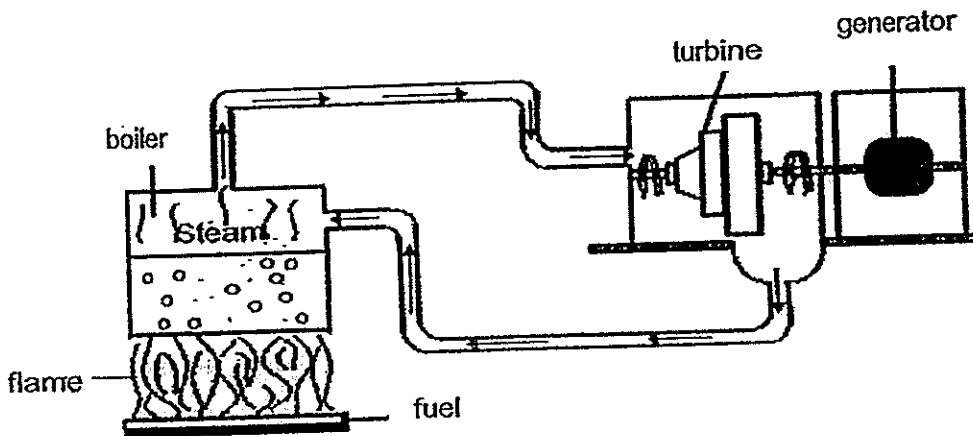

At which part of the power station is the correct form of energy conversion shown?

	Part	Energy Conversion
(1)	Boiler	heat energy \rightarrow electrical energy
(2)	Generator	electrical energy \rightarrow kinetic energy
(3)	Fuel	chemical potential energy \rightarrow heat energy
(4)	Turbine	kinetic energy \rightarrow chemical potential energy

- 28 Rafi conducted an experiment as shown in the diagram below. He stretched a rubber band with a stone to position A. When he released the stone, the rubber band and the stone moved forward and the stone hit the wall.

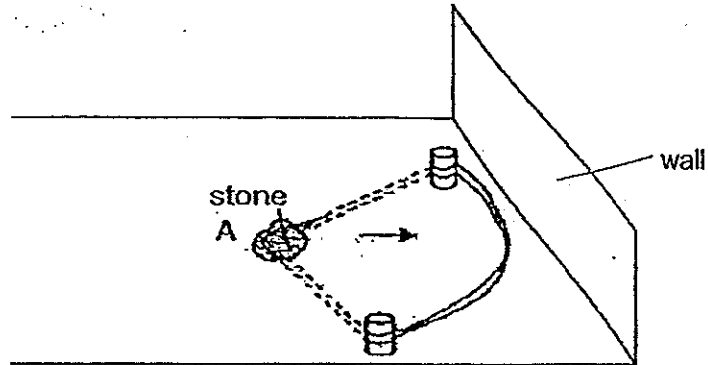

Which one of the following showed the correct energy conversion that took place from the moment Rafi released the rubber band till the stone hit the wall?

- | | |
|-----|--|
| (1) | Kinetic energy \rightarrow heat energy + sound energy |
| (2) | Potential energy \rightarrow heat energy + sound energy |
| (3) | Potential energy \rightarrow kinetic energy \rightarrow heat energy + sound energy |
| (4) | Kinetic energy \rightarrow potential energy \rightarrow heat energy + sound energy |

- 29 The diagram below shows a performance by two gymnasts, P and Q.

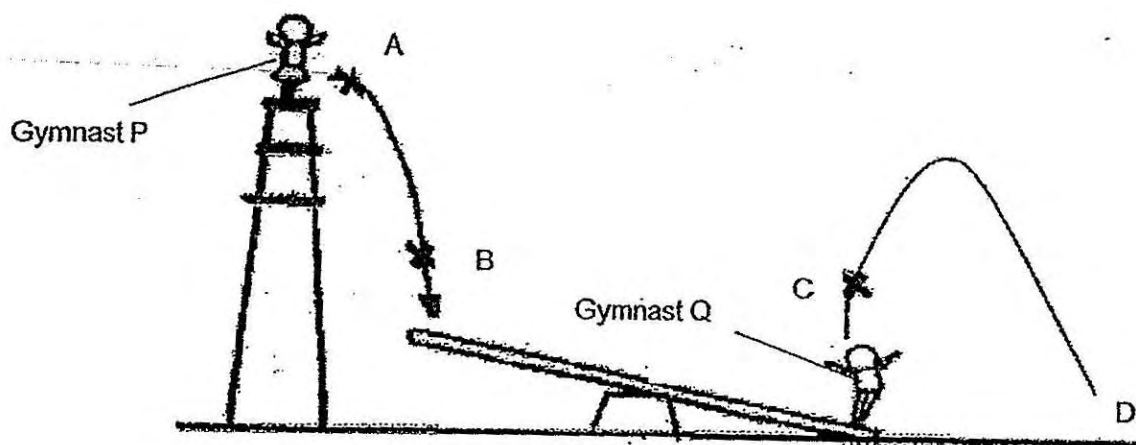

At which positions will the gymnasts possess more kinetic energy than gravitational potential energy?

- (1) A and C only
 - (2) A and D only
 - (3) B and C only
 - (4) B and D only
- 30 What are needed for photosynthesis to take place?
- (1) Oxygen and sugar
 - (2) Oxygen and water
 - (3) Carbon dioxide and sugar
 - (4) Carbon dioxide and water

End of Booklet A

Please go on to Booklet B

(Go on to the next page)



Anglo-Chinese School (Primary)

MID-YEAR EXAMINATION 2014
SCIENCE
PRIMARY SIX
BOOKLET B

Name: _____ ()

Class: Primary 6 _____

Date: 8 May 2014

Duration of paper: 1 h 45 min

Parent's/Guardian's Signature

INSTRUCTIONS TO CANDIDATES

1. This questions paper consists of 15 printed pages including this cover page.
2. Do not turn this page until you are told to do so.
3. Follow all questions.
4. Answer all questions.
5. Write your answer in this booklet.

BOOKLET	MAXIMUM MARKS	MARKS OBTAINED
A	60	
B	40	
Total	100	

For questions 31 to 44, write your answers in the spaces provided in this booklet.

The number of marks available is shown in the brackets [] at the end of each question or part question. (40 marks)

- 31 Ali wanted to find out how the presence of light affects the growth of mould on oranges. The orange in set-up A was left under a lamp in an air-tight glass container as shown in the diagram below. He observed that no mould was growing on the orange after five days.

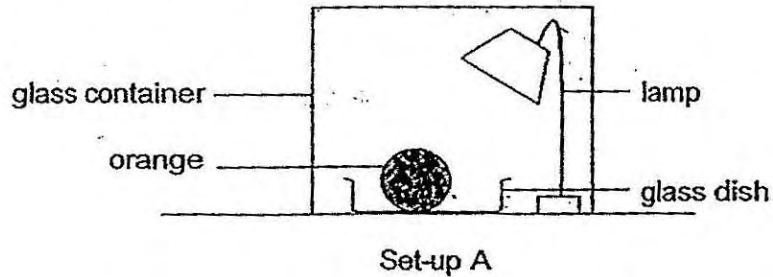

- (a) In the space below, draw and label how Ali should set up a control experiment. [1]

- (b) What is the purpose of having the control experiment? [1]

- (c) What can be done to the oranges in order to observe a change in them? [1]

(Go on to the next page)

Score	3
-------	---

- 32 Ravi put a plant into a beaker of water coloured with some red ink. The next day, he observed that some parts of the plant had turned red.

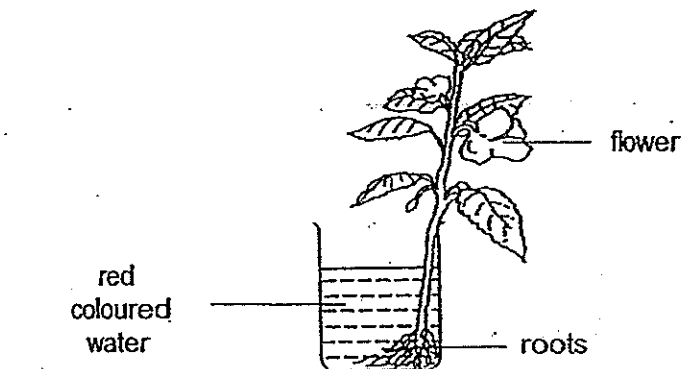

- (a) Which two parts of the plant would have turned red? [1]

- (b) Explain how this happened. [2]

- 33 Study the diagram of a cell as shown below.

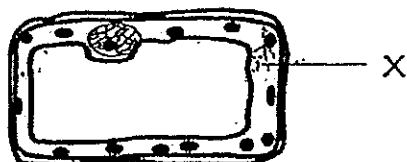

- (a) What is the function of part X of the cell? [1]

- (b) Draw and label all the parts of an animal cell in the space below. [2]

(Go on to the next page)

Score	
	6

- 34 A plank was placed horizontally on two similar springs, A and B, as shown below. Weight X and Weight Y were then placed on either side of the plank.

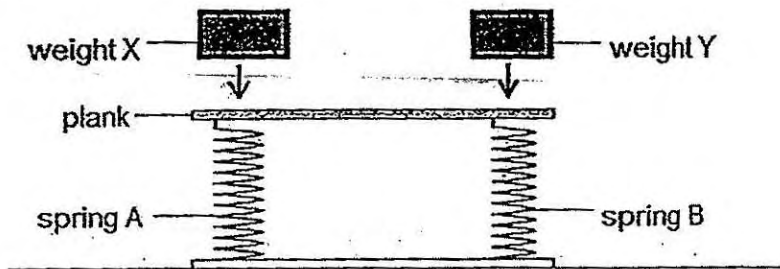

- (a) If Spring A was compressed more than Spring B, what can you infer about Weight X and Weight Y? [1]

- (b) Without removing the weights, how can the plank be returned to a horizontal position? [1]

- (c) How can you tell that both the springs are elastic? [1]

(Go on to the next page)

Score	3
-------	---

- 35 Jenny pulled object A up the inner wall of a container using a spring balance as shown below. At first, she applied lubricant X along the inner wall of the container. She recorded the amount of force needed to move the object over a distance of 20 cm.

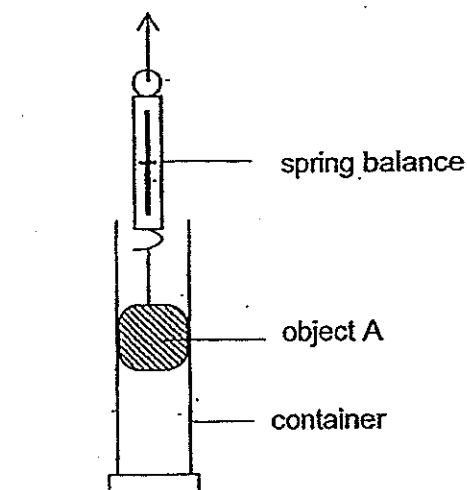

Jenny repeated the experiment using the same set-up and applied another type of lubricant, Y, along the inner wall of the container.

- (a) What was the aim of Jenny's experiment? [1]

- (b) What prevented object A from moving up the inner wall of the container easily? [1]

Jenny replaced object A with object B of the same mass and width as shown below. She repeated the experiment using lubricant X only.

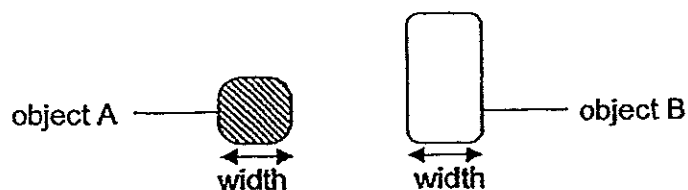

- (c) What did Jenny want to compare by using object A and object B? [1]

(Go on to the next page)

Score	3
-------	---

- 36 Henry wanted to compare how long two different springs, A and B, could stretch. The original lengths of the springs were equal.

Table 1 shows the results when different loads were hung from Spring A.

Table 1

Load (g)	Length of Spring A (cm)
10	4.5
20	9
30	13.5
40	18

- (a) Based on the results in Table 1, what would the length of Spring A most likely be if a load of 35 g was hung from Spring A? [1]

Table 2 shows the results when different loads were hung from Spring B.

Table 2

Load (g)	Length of Spring B (cm)
10	3
20	6
30	9
40	12

- (b) The graph below shows the change in the length of Spring A. Based on the results in Table 2, draw a line graph to show the change in the length of Spring B. Use a ruler and pencil. [1]

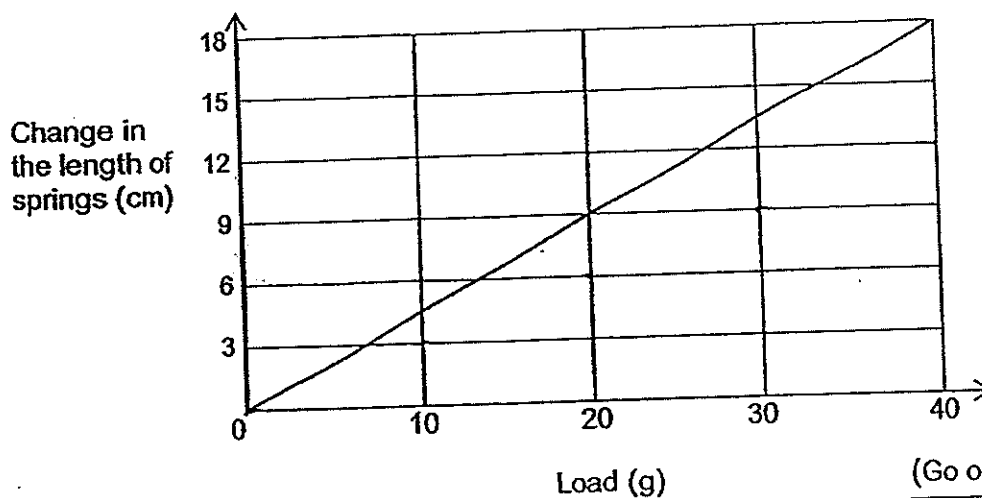

(Go on to the next page)

Score	2
-------	---

37. Ball A and Ball B were released at the same time, from the same height but on the opposite side of the symmetrical slope as shown below. After the balls have rolled down the slope and collided at the bottom of the slope, Ball A rolled to Point X while Ball B rolled to Point Y. The two balls finally came to a rest at the bottom of the slope.

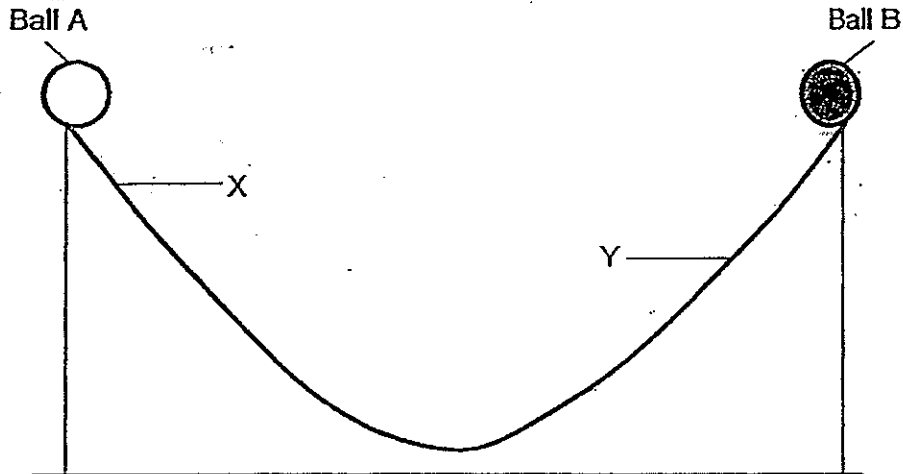

- (a) State the effect of force that was observed during this activity. [1]

- (b) What can you infer about the mass of the balls from the observation? [1]

- (c) Without adding any force, suggest a way so that Ball B is able to roll back to a point which is higher than Point Y after the collision with Ball A. [1]

(Go on to the next page)

Score	3
-------	---

- 38 Susan conducted an experiment as shown in the diagram below. She released a ball from a table and recorded the maximum height reached by the ball when it rebounded at points P and Q. The path taken by the ball was represented by the dotted lines.

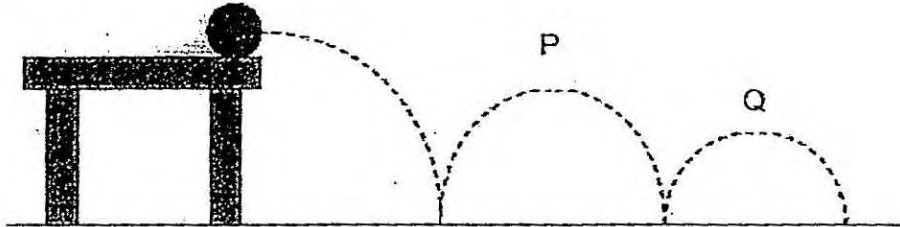

She recorded her results as shown in the table below.

Maximum height (cm) at	
P	Q
67	45

- (a) Why was there a difference in the bouncing heights at points P and Q? [1]

- (b) Suggest two ways in which she can make changes to the experiment such that the height of point P can be greater than 67 cm? [2]

(i) _____

(ii) _____

(Go on to the next page)

Score	3
-------	---

- 39 The diagram below shows a toy shark. Magnet X in the shark and Magnet Y in the plastic base cause the shark to suspend above the plastic base. The pivot attaches the toy shark to the plastic base.

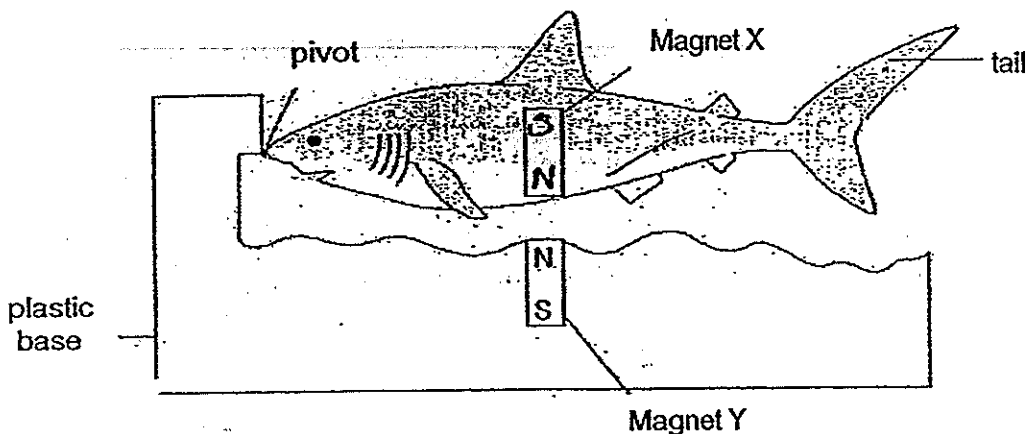

- (a) Write the letters N and S on Magnet X in the diagram above to label the poles of the magnet. [1]
- (b) Janet pressed down on the shark's tail with her finger. What happened to the shark when she removed her finger? Explain your answer. [1]

The diagram below shows four identical magnets that had been dipped into piles of shavings of four different metals: nickel, cobalt, aluminium and copper.

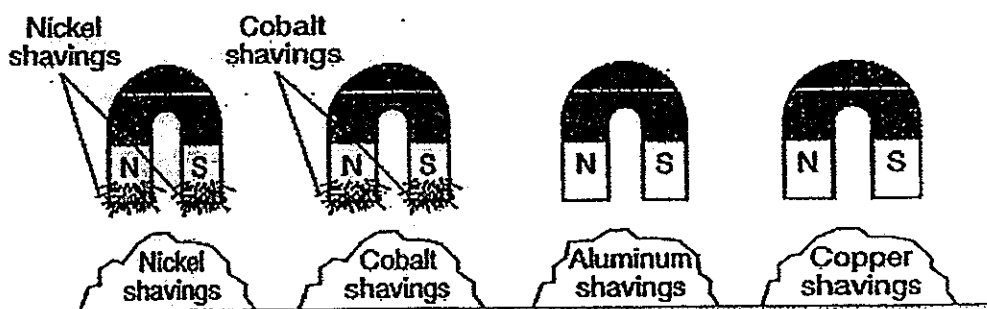

- (c) Based on the diagram above, what can you conclude about a magnet's ability to attract the different metals? [1]

(Go on to the next page)

Score	3
-------	---

40 The diagram shows a dam and an electric power plant built next to a river. The power plant uses the water from the dam to generate electricity.

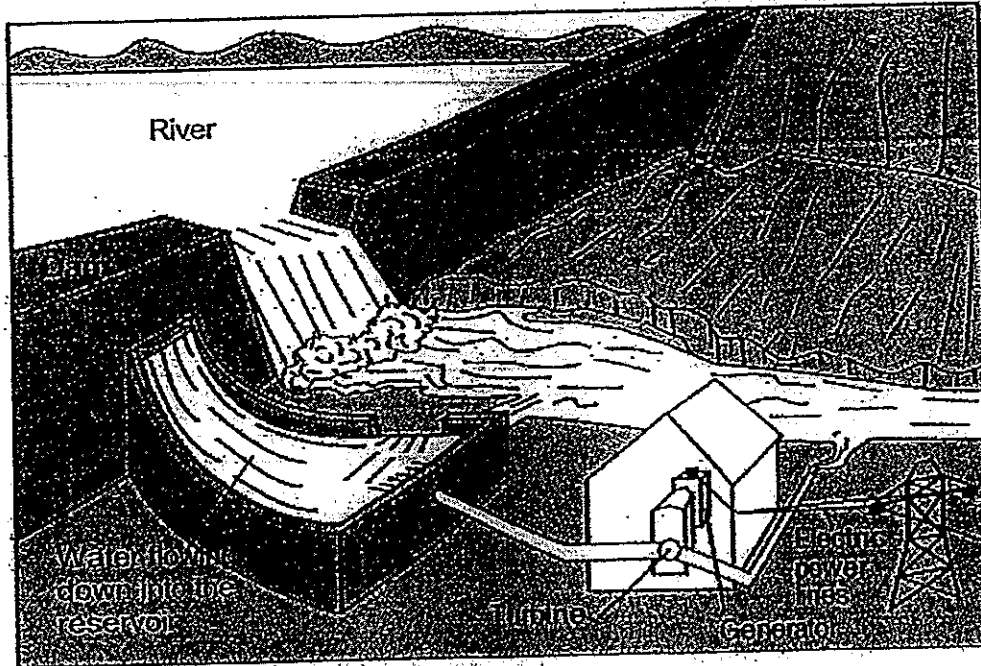

(a) Complete the energy conversion for the different stages in the power plant. [2]

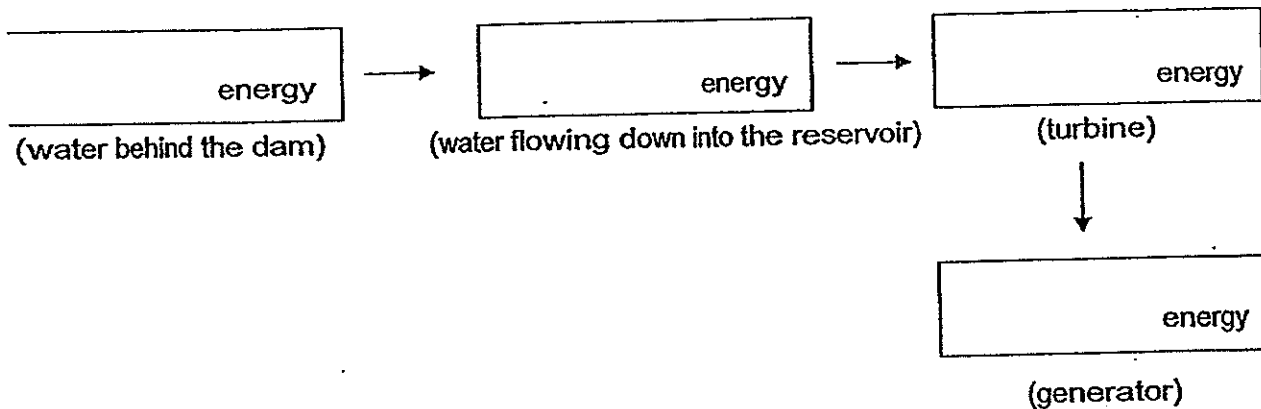

(b) Although the above method can be used to generate electricity without burning any fuels, why is this source of energy not used to provide electricity for homes in Singapore? [1]

(Go on to the next page)

Score	3
-------	---

- 41 The plant below was placed under a direct source of light for three days. Everyday, it was given an equal amount of water. One of the leaves was partially covered with black paper during the three days.

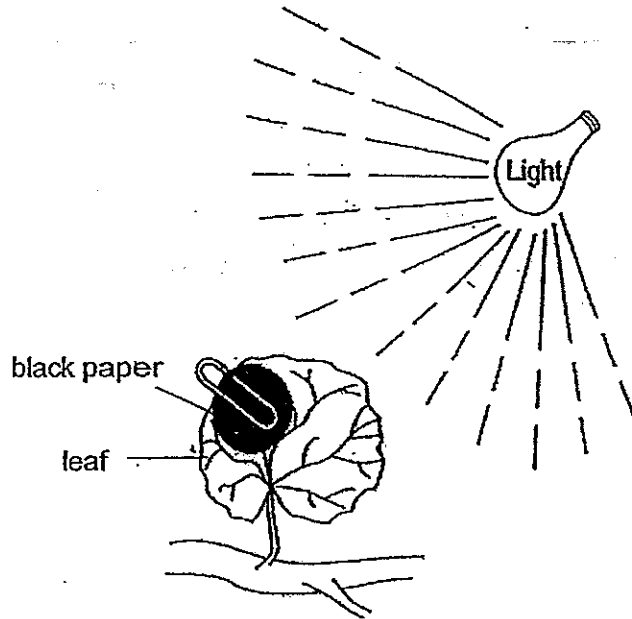

When the black paper was removed, the area that was covered by the black paper had turned pale. The pale area of the leaf did not contain starch and the remaining green area was found to contain starch after a starch test was conducted.

Explain the above observations.

[2]

(Go on to the next page)

Score	2
-------	---

42 The diagrams below show a metal ball and a ring before, during and immediately after heat was applied to the metal ball.

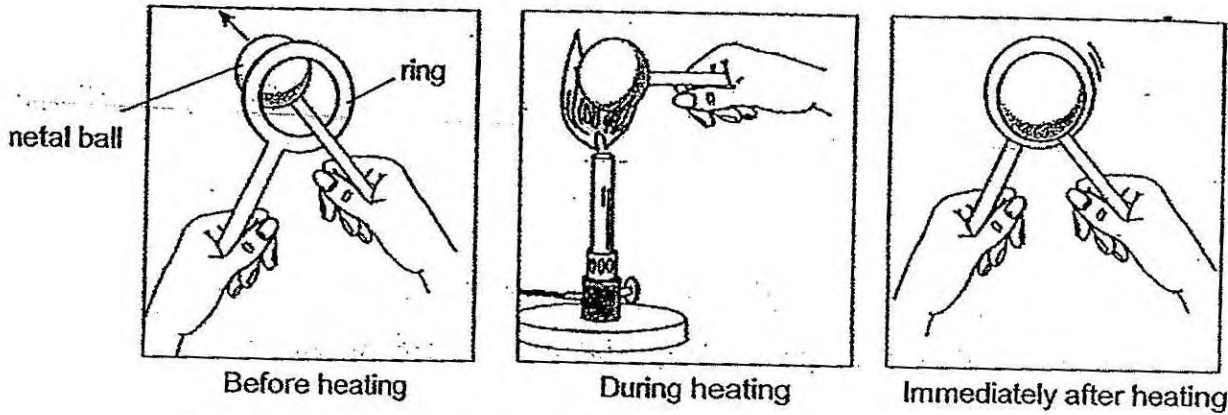

(a) What evidence shows that a change has taken place in the metal ball? [1]

(b) Explain how heating the metal ball had caused this change. [1]

The diagram below shows a railway track with small gaps in between.

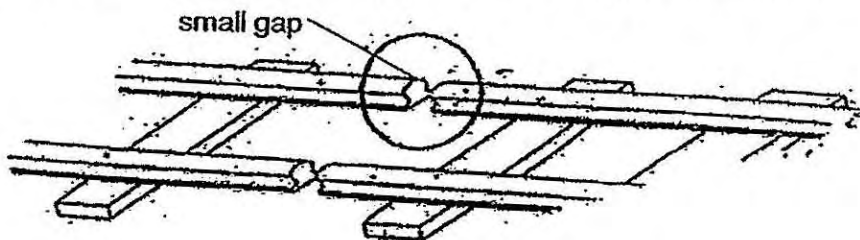

(c) Engineers designing a railway track leave small gaps in between the tracks for a purpose. Explain why the engineers do so. [1]

(Go on to the next page)

Score	3
-------	---

- 43 Dengue fever is an illness caused by infection transmitted by the *Aedes* mosquito. Bala studied the life cycle of the *Aedes* mosquitoes at different temperatures and observed how long each stage of their life cycle took.

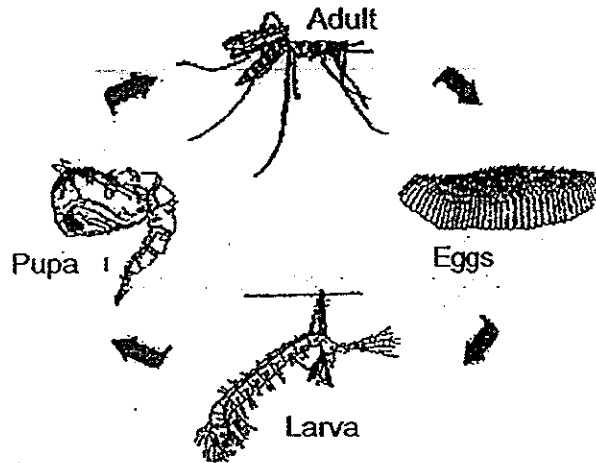

The results are shown in the table below:

	Duration of stage at different temperature (Days)			
	22°C	24°C	26°C	28°C
Egg	2	2	2	2
Larva	9	8	7	6
Pupa	2	2	2	2

- (a) Based on the results in the table above, what is the relationship between the temperature and the length of life cycle of the *Aedes* mosquito? [1]

- (b) Bala commented that as the temperature increases, the number of days that the eggs took to hatch decreases. Based on his results, was he correct? Explain your answer. [1]

(Question 43 continues on page 14)

Score	2
-------	---

The graph below shows how Singapore's average daily temperature has changed over the past 60 years.

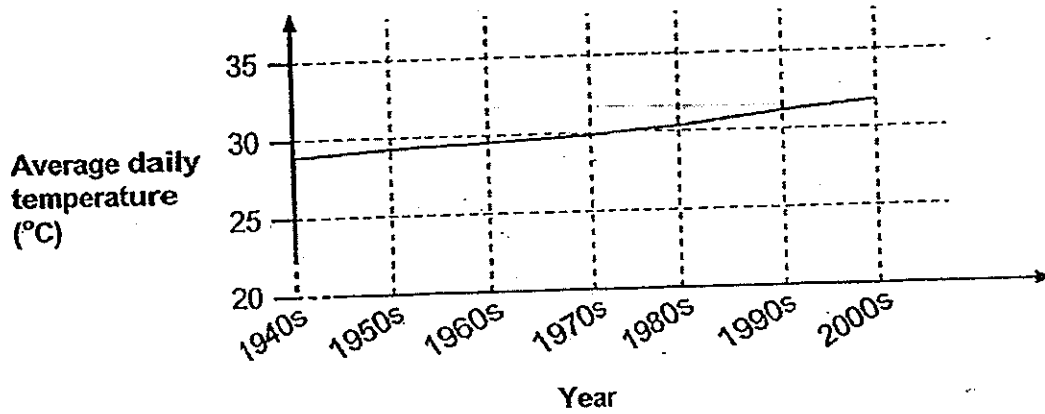

(c) Based on Bala's results and the graph above, how has the change in the average daily temperature affected the *Aedes* mosquito? [1]

(d) From your answer in (c), how will this affect humans? [1]

(Go on to the next page)

Score	2
-------	---

- 44 Carol hung a spiral above a candle. She then lighted the candle and observed that the spiral started to spin after a short while as shown below.

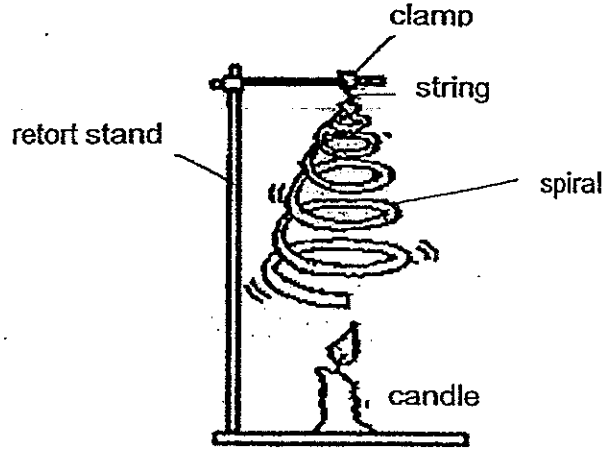

- (a) Write down the energy conversion that took place in the above experiment in the boxes below. (1)

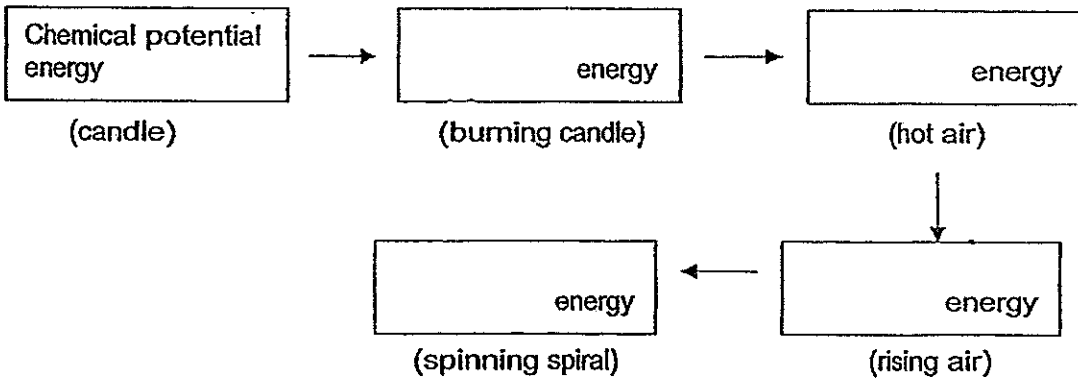

She then counted the number of spins made per minute and recorded her results in the table below.

Number of spins per minute			Average number of spins per minute
Try 1	Try 2	Try 3	
15	17	16	16

- (b) Explain what will happen to the average number of spins per minute if Carol placed three candles below the spiral instead of one. Explain your answer. (1)

End of Booklet B

Please check your answers carefully

Score	2
-------	---

ANSWER SHEET

EXAM PAPER 2014

SCHOOL : ACS

SUBJECT : PRIMARY 6 SCIENCE

TERM : SA1

Q1	Q2	Q3	Q4	Q5	Q6	Q7	Q8	Q9	Q10	Q11	Q12	Q13	Q14	Q15	Q16	Q17
2	1	4	4	4	2	4	1	4	4	1	3	1	1	2	3	4

Q18	Q19	Q20	Q21	Q22	Q23	Q24	Q25	Q26	Q27	Q28	Q29	Q30
4	2	4	3	4	3	3	2	1	3	3	4	4

31)a)

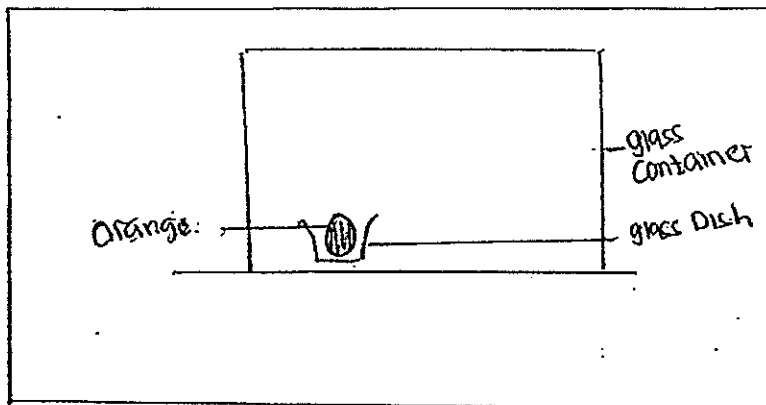

b) To confirm that the presence of light cause or does not cause the growth of mould.

c) Place the oranges in a damp dark place.

32)a) The stem and the flower.

b) The roots absorb the red coloured water, so the water went from roots to the stem to the flowers making it red.

33)a) X controls the movement in the cell.

b)

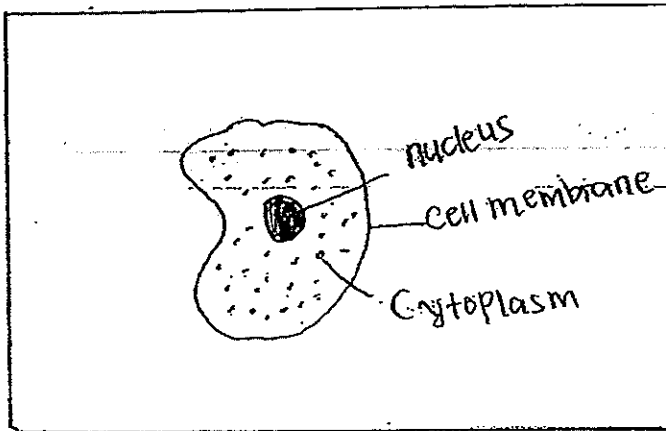

34)a) Weight X would be heavier than Weight Y.

b) Deduct the mass of X and Y, finding out how much heavier is X. Then add the difference to Y.

c) The springs must be able to return to its original length.

35)a) To find if the type of lubricant will affect the amount of force needed to move the object.

b) Frictional force & Gravitational force.

c) To compare the amount of force needed to move up the objects if the surface areas in contact are different.

36)a) 16.5cm

b)

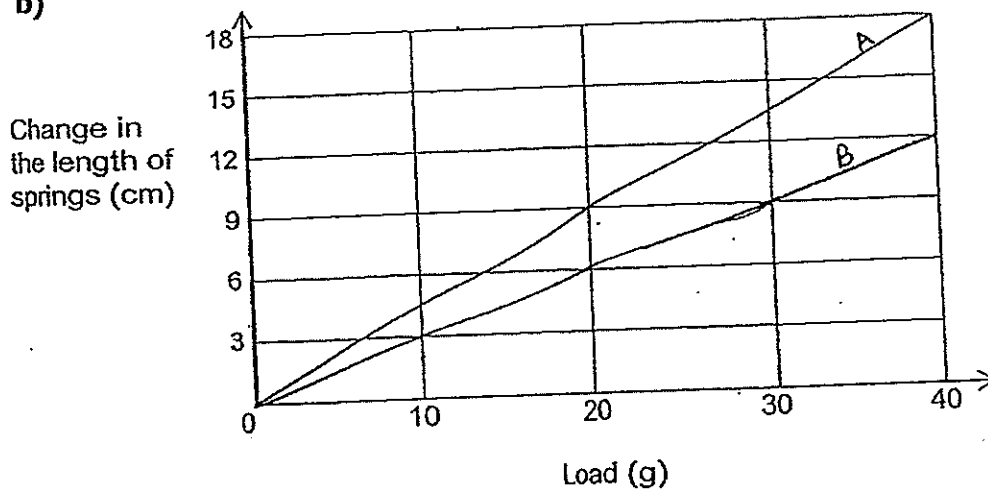

37)a) A force can make a moving object change directions.

b) Ball B is heavier than Ball A.

c) Apply lubricant on side.

38)a)As the ball bounces the kinetic energy in the ball converts into heat and sound energy so the ball lost its bounce over time.

b)i)Change the balls mass greater.

ii)Use a taller table.

39)a)S

N

b)The shark returned to its original position. The magnet continues to be repelled so the shark has to go back to its original position.

c)The magnets can attract Nickel and Cobalt shavings but cannot attract or copper shavings.

40)a)Potential energy → Kinetic energy → Kinetic energy

↓
electrical energy

b)There is not enough land in Singapore to built this.

41)When the paper covers the plant, the plant cannot photosynthesis, then that part of the plant will die, After the part of the plant dies, the part will become pale and the starch is lost,so the remaining sections are exposed to light and can carry out photosynthesis.

42)a)It could go through the ring but after heating it could not.

b)When it was heated the metal ball expanded when it did , it could not go through the ring anymore.

c)During hot weather the sun will heat the metal rails, when it does, the rails will expand when it does will cover up the gaps. If the gaps were not there, the rails would expand and the rails and the rails will be damaged.

43)a)The higher the temperature, the faster the life cycle.

b)No. The amount days it took for the egg to hatch is constant.

c)It allowed the mosquitos to breed faster.

d)It will make humans sick more often.

44)a)Heat energy → Heat energy

↓
Kinetic energy ← Wind energy

b)The number of spin will increase. There is now more heat energy from the flame of the candles, which is converted to more KE of the air rises and then converted to more KE of the spiral.

