

Prelim

Index No.

--	--	--	--	--	--	--	--



NAN HUA PRIMARY SCHOOL
PRELIMINARY EXAMINATION – 2017
PRIMARY 6

MATHEMATICS

Paper 1

Section A: 15 Multiple Choice Questions (20 marks)

Section B: 15 Short Answer Questions (20 marks)

Total Time for Paper 1: 50 minutes

INSTRUCTION TO CANDIDATES

1. Write your name and index number in the space provided.
2. Do not turn over the page until you are told to do so.
3. Follow all instructions carefully.
4. Answer all questions.
5. Shade your answers in the Optical Answer Sheet (OAS) provided for Questions 1-15.
6. You are not allowed to use calculator for Paper 1.

Marks Obtained

Paper 1	Booklet A		/ 40
	Booklet B		
Paper 2			/ 60
Total			/ 100

Name : _____ ()

Class : 6 _____

Date : 23 August 2017

Parent's Signature : _____

Section A (20marks)

Questions 1 to 10 carry 1 mark each.

Questions 11 to 15 carry 2 marks each.

For each question, four options are given. One of them is the correct answer.

Make your choice (1, 2, 3 or 4). Shade the oval (1, 2, 3 or 4) on the Optical Answer Sheet.

1. How many 1000s are there in 2 100 000?

- (1) 21
- (2) 210
- (3) 2100
- (4) 21 000

2. Which one of the following is the most likely mass of a new toilet paper roll?

- (1) 10 g
- (2) 100 g
- (3) 1 kg
- (4) 10 kg

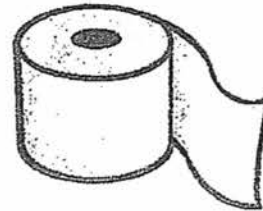

3. Round 586 783 to the nearest thousand.

- (1) 586 000
- (2) 587 000
- (3) 590 000
- (4) 600 000

4. What is the missing number in the box?

$$2 : 3 = \square : 12$$

- (1) 6
 - (2) 7
 - (3) 8
 - (4) 4
5. Which one of the following fractions is smaller than $\frac{1}{2}$?

(1) $\frac{10}{21}$

(2) $\frac{9}{17}$

(3) $\frac{7}{13}$

(4) $\frac{6}{11}$

6. The figure below shows a square-based pyramid.

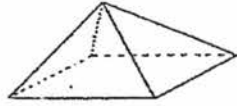

Which one of the following is a possible net of the square-based pyramid?

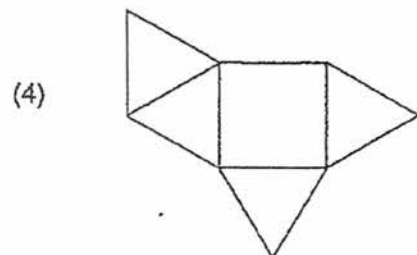
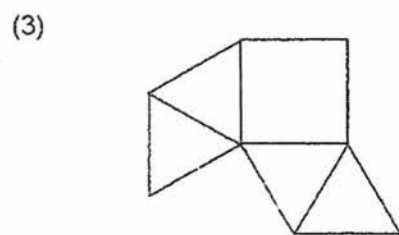
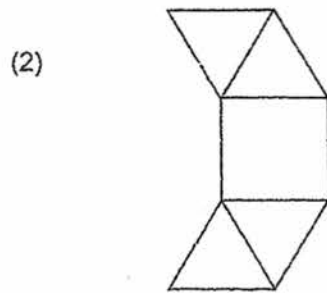
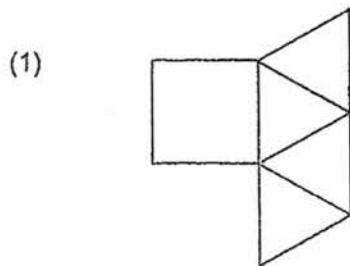

7. A number when rounded to the nearest tenth is 4.0. Which of the following is the original number?

- (1) 3.898
- (2) 3.945
- (3) 4.046
- (4) 4.196

8. Alan took part in a 100 m freestyle swimming race. His performance was shown in the line graph below.

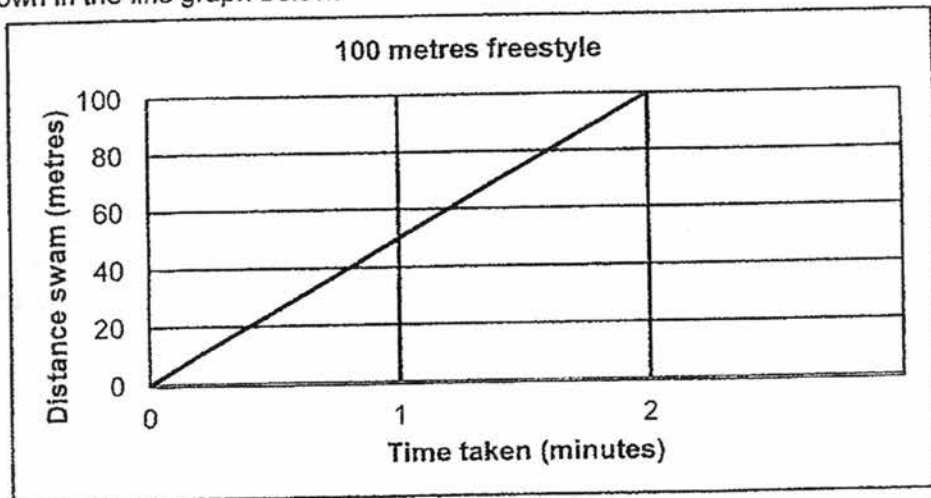

What was his average speed for the whole swimming race?

- (1) 50 m/min
- (2) 75 m/min
- (3) 100 m/min
- (4) 150 m/min

9. The table below shows the test marks obtained by a pupil in Mathematics.

Mathematics	Marks (out of 50)
First test	40
Second test	50

Find the percentage increase in his marks.

- (1) 100%
- (2) 80%
- (3) 25%
- (4) 20%
10. Three triangles are drawn within a grid of 4 identical rectangles. What fraction of the grid is shaded?

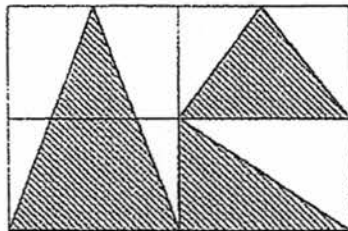

- (1) $\frac{1}{4}$
- (2) $\frac{3}{8}$
- (3) $\frac{1}{2}$
- (4) $\frac{3}{4}$

11. In the figure, ABCD is a rhombus and BEC is an equilateral triangle. Find $\angle BAE$.

- (1) 11°
 (2) 19°
 (3) 22°
 (4) 38°

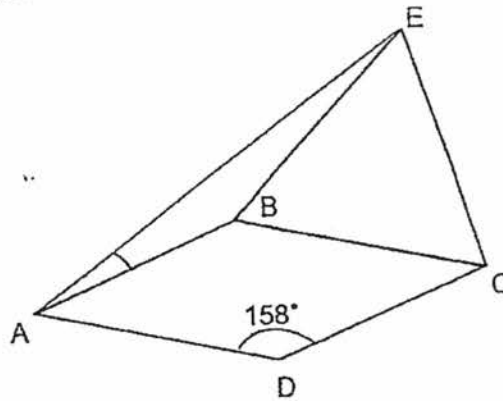

12. Two rectangular tanks are shown below. Tank A contained water to half its height. Half of the water from Tank A was poured into Tank B without spilling.

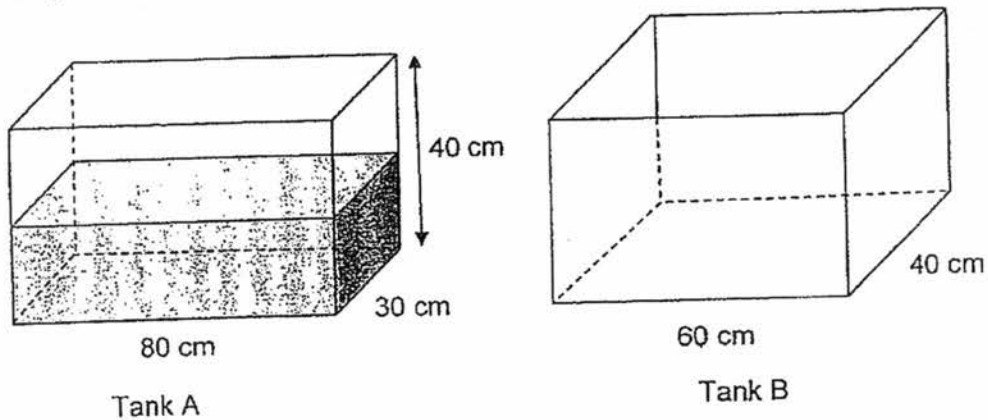

What is the height of the water level in Tank B now?

- (1) 10 cm
 (2) 20 cm
 (3) 40 cm
 (4) 48 cm

13. The pie chart below shows the different types of cupcakes sold at a bakery. The number of chocolate cupcakes sold was $\frac{4}{5}$ of the number of cookies and cream cupcakes sold. What fraction of the cupcakes sold was cookies and cream?

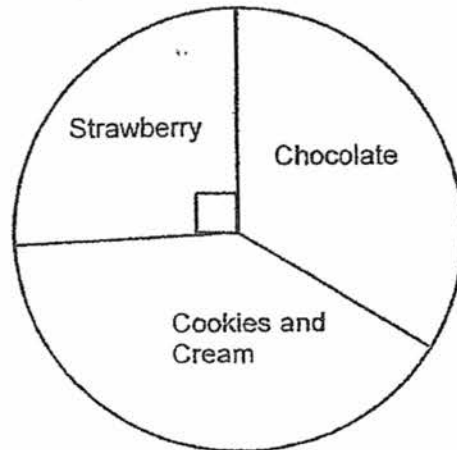

- (1) $\frac{1}{3}$
(2) $\frac{5}{12}$
(3) $\frac{4}{9}$
(4) $\frac{5}{9}$

14. The figure shows a quarter circle in a semicircle. The diameter of the semicircle is 14 cm. Find the area of the unshaded parts. (Take $\pi = \frac{22}{7}$)

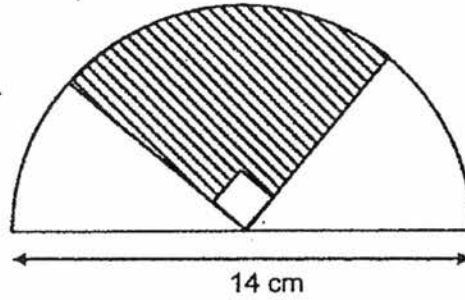

- (1) 38.5 cm^2
(2) 77 cm^2
(3) 154 cm^2
(4) 308 cm^2
15. Nina and Polly had \$372 altogether. Nina spent twice as much money as Polly. The amount of money Polly had left was \$8 more than what she had spent. She had twice as much money left as Nina. How much money did Polly spend?
- (1) \$40
(2) \$80
(3) \$160
(4) \$168

Section B (20 marks)

Questions 16 to 25 carry 1 mark each. Write your answers in the spaces provided.
For questions which require units, give your answers in the units stated.
[10 marks]

16.

4	6	9
---	---	---

Using each digit only once, form the smallest three-digit number which is a multiple of 4.

Ans: _____

17. What is 9045 divided by 45?

Ans: _____

18. Ms Lee has $\frac{1}{6}$ kg flour. She uses $\frac{2}{5}$ of it to make some cupcakes. How much flour does she have left?

Ans: _____ kg

Do not write
in this space

19. Yixian ran at a speed of 15 km/h for 40 min. How far did he run?

Do not write
in this space

Ans: _____ km

20. The total area of the 6 faces of a cube is 150 cm². What is the volume of the cube?

Ans: _____ cm³

21. Germaine is facing the cinema. If she turns 225° anticlockwise, where will she be facing?

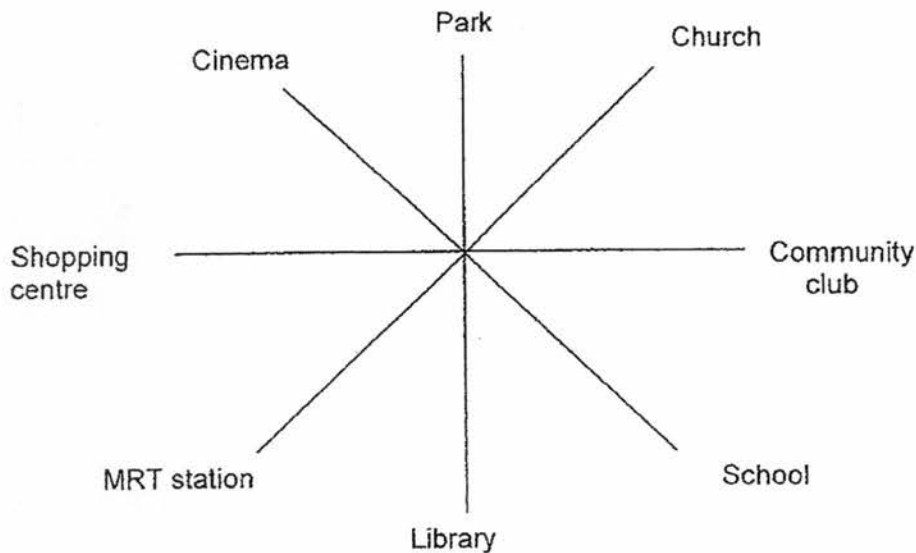

Ans: _____

22. The figure below is made up of 10 identical squares. Draw a line of symmetry in the figure below.

Do not write in this space

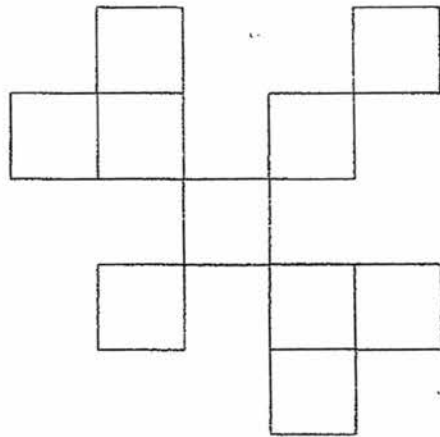

-
23. Simplify $14q - 3 - 6q + 6$.

Ans: _____

24. The figure below is made up of 2 identical smaller semicircles and a bigger semicircle. O is the centre of the bigger semicircle of radius 7 cm. Find the perimeter of the whole figure. (Take $\pi = \frac{22}{7}$)

Do not write
in this space

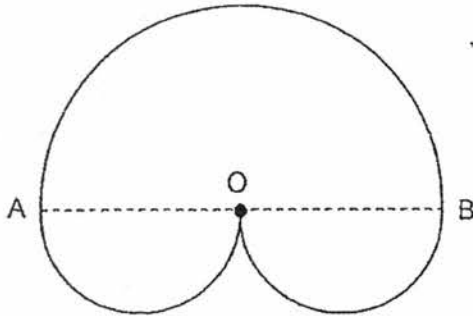

Ans: _____ cm

25. The pie chart below shows the different hobbies that a group of pupils have. Each pupil has only 1 hobby. 4 more pupils like reading than playing chess. How many pupils are there altogether?



Ans: _____

Questions 26 to 30 carry 2 marks each. Show your working clearly in the space provided for each question and write your answers in the spaces provided. For each questions which require units, give your answers in the units stated. [10 marks]

26. The shaded figure below is formed by a semicircle and a quadrant. The radius of the quadrant is 35 cm. Find the perimeter of the shaded part. (Take $\pi = \frac{22}{7}$)

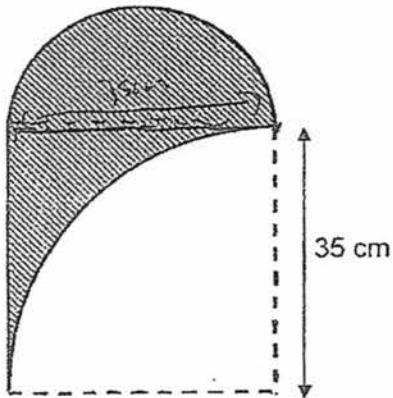

Ans: _____ cm



27. There are 2 triangles, A and B in the figure below. What is the ratio of the area of triangle A to the area of triangle B? (Leave your answer in the simplest form)

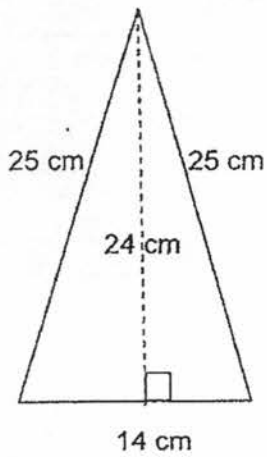

Triangle A

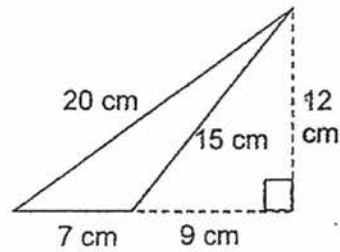

Triangle B

Ans : _____

Do not write
in this space

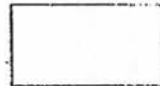

28. PQRS and VWRS are parallelograms and UVST is a square. Given that TW is a straight line, find $\angle VPQ$.

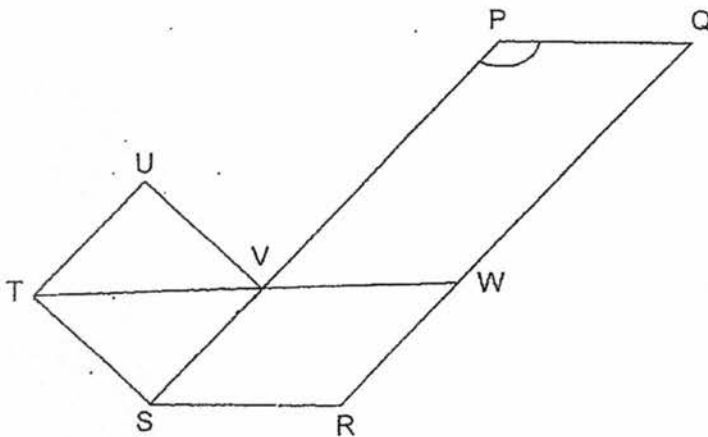

Ans : _____

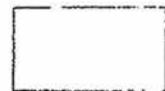

29. Jay folds a piece of rectangular paper along its diagonal AB as shown in the diagram below.

Do not write
in this space

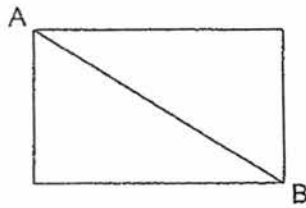

Figure 1

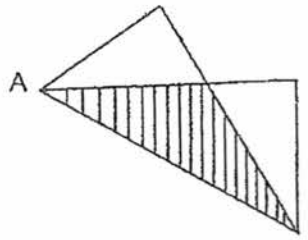

Figure 2

The ratio of the area of Figure 2 to the area of Figure 1 is 4 : 7. If the area of the shaded part is 24 cm^2 , find the area of the piece of rectangular paper in Figure 1.

Ans : _____ cm^2



30. The figure below is formed by a square BDEF and a quadrant. Given that $DF = 14$ cm, find the total area of the shaded parts. (Take $\pi = \frac{22}{7}$)

Do not write
in this space

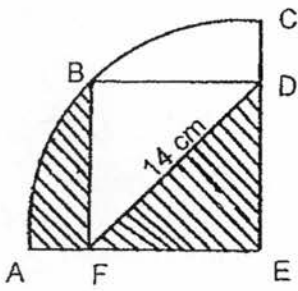

Ans: _____ cm²

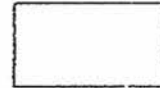

END OF PAPER

Index No.

--	--	--	--	--	--



NAN HUA PRIMARY SCHOOL
PRELIMINARY EXAMINATION – 2017
PRIMARY 6

MATHEMATICS

Paper 2

Total Time for Paper 2: 1 hour 40 minutes

5 Short Answer Questions (10 marks)

13 Structured / Long Answer Questions (50 marks)

INSTRUCTION TO CANDIDATES

1. Write your name and index number in the space provided.
2. Do not turn over the page until you are told to do so.
3. Follow all instructions carefully
4. Answer all questions and show your workings clearly.
5. You are allowed to use a calculator.

Marks Obtained

Total		/ 60
-------	--	------

Name : _____ ()

Class : 6 _____

Date : 23 August 2017

Parent's Signature : _____

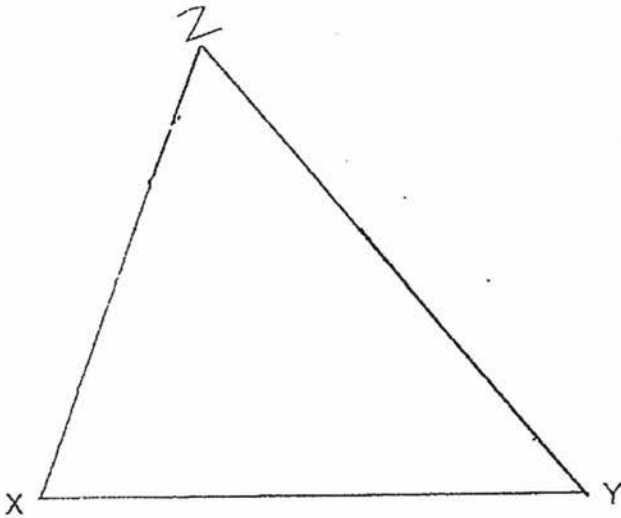
<p>3.</p>	<p>A pen cost \$2.80 and a file cost \$3.60. Tony bought an equal number of such pens and files. If he spent \$13.60 more on the files than the pens, how many pens did he buy?</p> <p style="text-align: right;">Ans: _____ pens</p>	<p>Do not write in this space</p> <div style="border: 1px solid black; width: 80px; height: 20px; margin: 0 auto;"></div>
<p>4.</p>	<p>Using the line XY, construct a triangle XYZ in the space below, such that $\angle XYZ = 50^\circ$ and $XZ = 7$ cm. Label your triangle clearly.</p> <div style="text-align: center; margin: 20px 0;">  </div>	<div style="border: 1px solid black; width: 80px; height: 20px; margin: 0 auto;"></div>

5. The figure below shows a picture (shaded part) surrounded by a 5 cm border. The outer border measures 33 cm by 20 cm. What is the area of the picture?

Do not write in this space

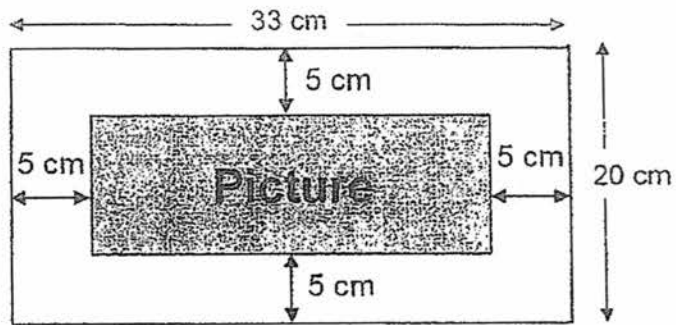

Ans: _____ cm²

8. The figure below shows the net of a box. Three of its faces had areas 6 cm^2 , 12 cm^2 and 18 cm^2 as shown.
- a) Write down the length (L), breadth (B) and height (H) of the box after the net was folded.
- b) Find the volume of the box after the net was folded.

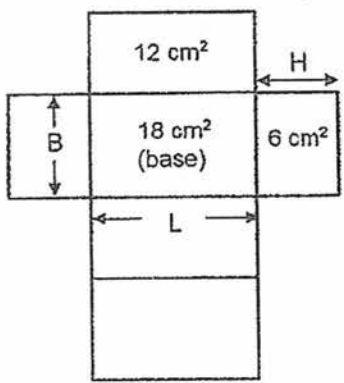

Ans: a) Length: _____, Breadth: _____, Height : _____ [1]

b) _____ [2]

9. Sally and Ken drove from Town A to Town B at constant speeds. Ken started his journey 2 hours after Sally. Ken travelled faster than Sally by 40 km/h and overtook her in 3 hours. Find Sally's speed.

Ans: _____ [3]

10. Two identical isosceles triangles, ABC and ADE, overlapped as shown in the figure below. Given that $BA = BC$, $DA = DE$ and $\angle COD = 54^\circ$, find $\angle CAE$.

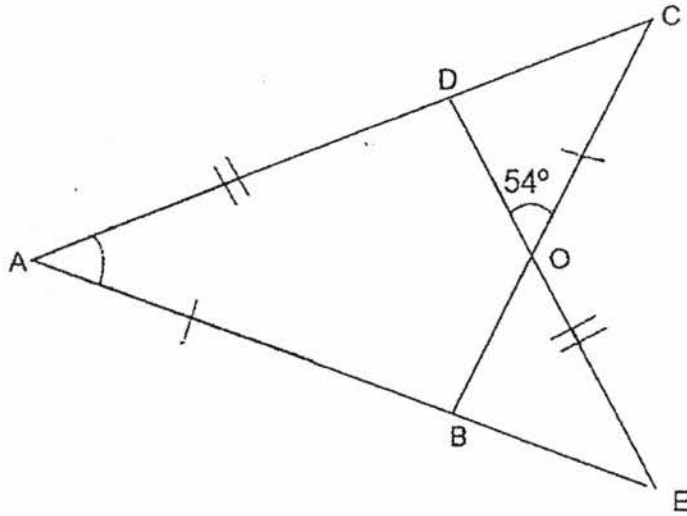

Ans:

[3]

11. Rongcai had \$1053 more than Caris. After Rongcai gave $\frac{2}{9}$ of his money to Caris, they each had the same amount of money.
How much money did Caris have at first?

Ans: _____ [3]

12. In Country X, the height of six 10-cent coins is the same as that of five 20-cent coins as shown in diagram 1. Diagram 2 shows an unknown number of such 10-cent coins stacked to the same height as another stack of such 20-cent coins.

- If the total value of the 2 stacks of coins in diagram 2 is \$88,
 a) find the number of 10-cent coins used in diagram 2.
 b) find the value of all the 20-cent coins used in diagram 2.

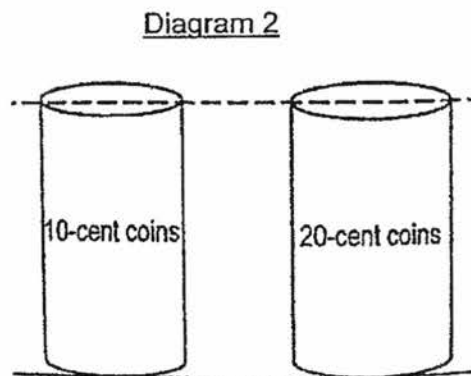
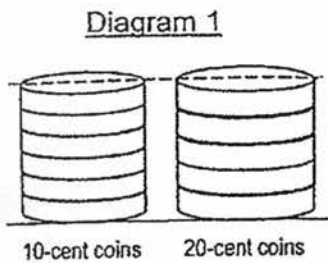

Ans: a) _____ [2]

b) _____ [2]

13. The figure below shows 3 identical circles drawn within a rectangle. The two slanted lines are the diagonals of the rectangle and OM is a straight line. If the length of the rectangle is 294 cm, what is the total area of the unshaded parts? (Take $\pi = \frac{22}{7}$).

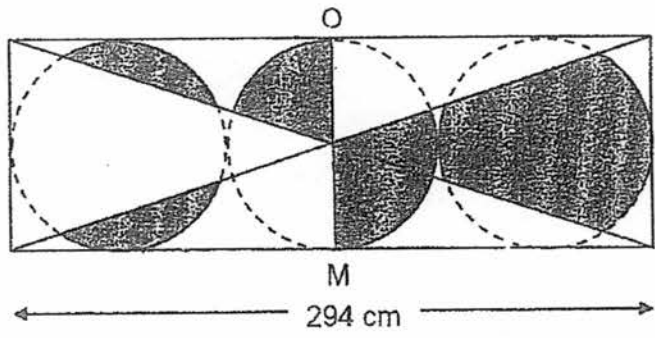

Ans: _____ [5]

14. There were some adults and children at a party. 190 more boys then joined in, while 65 adults left. As a result, the percentage of girls in the party decreased from 36% to 24%.

- a) Find the percentage increase in the total number of people at the party.
- b) Find the number of girls at the party.

Ans: a) _____ [2]

b) _____ [2]

15. Danny and Petsy each borrowed an identical book from a library. On the first day, Danny read $\frac{1}{3}$ of the book plus 28 pages. On the second day, he read $\frac{2}{5}$ of the remaining book and had 42 pages of the book left. If Petsy read at most 20 pages of the book daily, what is the least number of days Petsy would take to finish reading the book?

Ans: _____ [5]

16. A sealed L-shaped container, partially filled with oil (shaded part), was toppled clockwise into another position as shown. The air space in diagram 1 was 3360 cm^3 . Using the dimensions given below, find the volume of oil in the container.

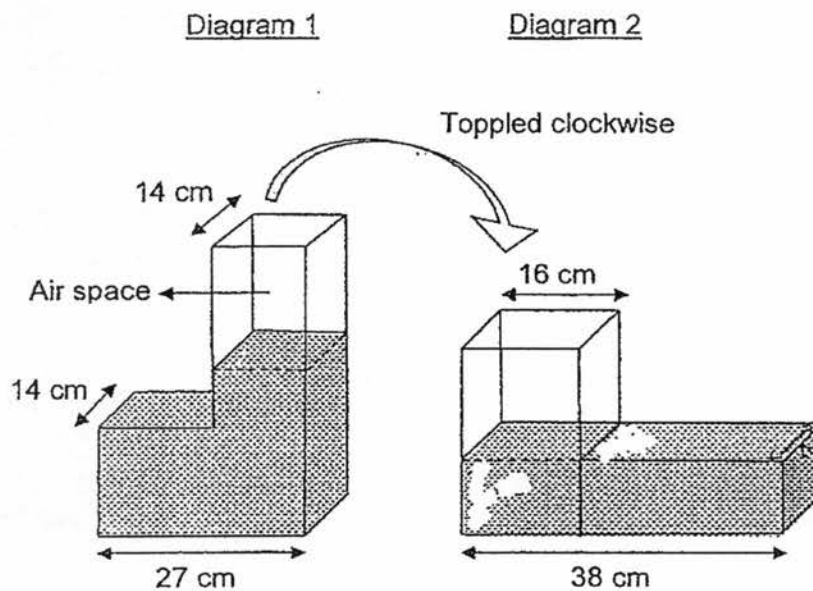

Ans: _____ [5]

17. At a fruit stall, the ratio of the number of avocados to that of the peaches to that of the lemons was 2 : 9 : 8 at first. The stall owner then sold 52 avocados, 12 peaches and 60 lemons. As a result, the ratio of the number of peaches to that of the lemons became 6 : 5. What was the total number of avocados, peaches and lemons left in the stall at the end?

Ans: _____ [5]

18. Hatta formed some figures that followed a pattern using squares and circles as shown below.

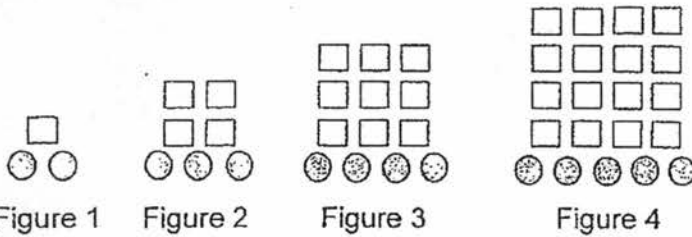

The table shows the number of squares and circles for the first four figures.

Figure number	1	2	3	4
Number of squares	1	4	9	16
Number of circles	2	3	4	5
Number of squares divided by	0 R1	1 R1	2 R1	3 R1
Number of circles	Note: "R" denotes remainder in the above columns.			

- a) A Figure number has 3481 squares. Find the answer when its number of squares is divided by its number of circles.
- b) In a certain Figure number, 99 R1 is obtained when its number of squares is divided by its number of circles. Find the total number of squares and circles in that Figure number.

Ans: a) _____ [2]

b) _____ [2]

– End of Paper 2 –

YEAR : 2017
LEVEL : PRIMARY 6
SCHOOL : NAN HUA PRIMARY
SUBJECT : MATHEMATICS
TERM : PRELIMINARY EXAMINATION

Paper 1

Q1	3	Q4	3	Q7	3	Q10	3	Q13	2
Q2	2	Q5	1	Q8	1	Q11	2	Q14	1
Q3	2	Q6	4	Q9	3	Q12	1	Q15	2

Q16 496

Q17 201

Q18 $\frac{1}{10}$ kg

Q19 10 km

Q20 125 cm³

Q21 community club

Q22



Q23 $8q + 3$

Q24 44 cm

Q25 70 pupils

Q26 145 cm

Q27 4 : 1

Q28 135 °

Q29 56 cm²

Q30 77 cm²

Paper 2

Q1 $10 + 2 = 12$
 $12 \div 2 = 6$
 $6 - 2 = 4 \Rightarrow$ 4y stamps

Q2 $6 + 4 = 10$
 $15 - 10 = 5$
 $20 \div 5 = 4$
 $4 \times 15 \Rightarrow$ \$60

Q3 $3.60 - 2.80 = 0.80$
 $13.60 \div 0.80 \Rightarrow$ 17 pens

Q4

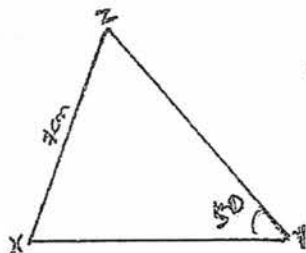

Q5 Length $\rightarrow 33 - 5 - 5 = 23$
Breadth $\rightarrow 20 - 5 - 5 = 10$
Area $\rightarrow 23 \times 10 \Rightarrow$ 230 cm²

NAN HUA PRELM

Q6 $1300 \times 2 = 2600$
 $3440 - 2600 = 840$
 $4 - 2 = 2$
 $840 \div 2 \Rightarrow \underline{420 \text{ cows}}$

Q7 $34 \div 2 = 17$
 $17 \times 4 = 68$
 $17 \times 2 = 34$
 $2890 + 68 + 34 = 2992$
 $2992 \div 34 \Rightarrow \underline{88}$

Q8 (a) Length: 6 cm , Breadth: 3 cm , Height: 2 cm

(b) Volume $\rightarrow 6 \times 3 \times 2 \Rightarrow \underline{36 \text{ cm}^3}$

Q9 $40 \times 3 = 120$
 $120 \div 2 \Rightarrow \underline{60 \text{ km/h}}$

Q10 $180 - 84 = 96$
 $180 - 96 = 84$
 $84 \div 2 = 42$
 $180 - 54 - 84 \Rightarrow \underline{42^\circ}$

Q11 $1053 \div 2 = 526.50$
 $526.5 \div 2 = 263.25$
 $263.25 \times 9 = 2369.25$
 $2369.25 - 1053 \Rightarrow \underline{\$1316.25}$

Q12 (a) $88 \div 1.60 = 55$
 $55 \times 6 \Rightarrow \underline{330}$

(b) $55 \times 5 = 275$
 $275 \times 0.20 \Rightarrow \underline{\$55}$

Q13 $294 \div 3 = 98$

$98 \div 2 = 49$

Total shaded $\rightarrow 1\frac{1}{2} \times \frac{22}{7} \times 49 \times 49 = 11319$

Area of rectangle $\rightarrow 294 \times 98 = 28812$

Unshaded $\rightarrow 28812 - 11319 \Rightarrow \underline{17493 \text{ cm}^2}$

Q14 (a) $5 \times 50 = 250$

$5 \times 75 = 375$

$\frac{375 - 250}{250} \times 100 \Rightarrow \underline{50\%}$

(b) $5 \times 18 \Rightarrow \underline{90 \text{ girls}}$

Q15 $\frac{42}{3} \times 5 = 70$

$70 + 28 = 98$

$\frac{98}{2} \times 3 = 147$

$147 \div 20 = 7R7$

$7 + 1 \Rightarrow \underline{8 \text{ days}}$

Q16 $14 \times 16 = 224$

$3360 \div 224 = 15$

$27 - 15 = 12$

Volume $\rightarrow 33 \times 14 \times 12 \Rightarrow \underline{6384 \text{ cm}^3}$

NAN HUA PRELIM

Q17 $45u - 60 = 30p$

$$9u - 12 = 6p$$

$$8u - 60 = 5p$$

$$48u - 360 = 30p$$

$$3u \rightarrow 360 - 60 = 300$$

$$1u \rightarrow 300 \div 3 = 100$$

$$100 \times 19 = 1900$$

$$1900 - 52 - 12 - 60 \Rightarrow \underline{1776 \text{ fruits}}$$

Q18 (a) $\sqrt{3481} = 59$

$$3481 \div 60 \Rightarrow \underline{58R1}$$

(b) $99 + 1 = 100$

$$100 \times 100 = 10000$$

$$100 + 1 = 101$$

$$10000 + 101 \Rightarrow \underline{10101 \text{ squares and circles}}$$

End

