

PRELIM

Name : _____ ()

Class : Primary 6 _____

CHIJ ST NICHOLAS GIRLS' SCHOOL (PRIMARY)



Primary 6 Mathematics

2017 Preliminary Examination

Paper 1

Booklet A

22 AUGUST 2017

15 QUESTIONS
20 MARKS

TOTAL TIME FOR BOOKLET A & B : 50 MINUTES

INSTRUCTIONS TO CANDIDATES

DO NOT TURN OVER THIS PAGE UNTIL YOU ARE TOLD TO DO SO.

FOLLOW ALL INSTRUCTIONS CAREFULLY.

ANSWER ALL QUESTIONS.

SHADE YOUR ANSWERS IN THE OPTICAL ANSWER SHEET (OAS) PROVIDED.

THE USE OF CALCULATORS IS NOT ALLOWED.

This booklet consists of 8 printed pages including the cover page.

Questions 1 to 10 carry 1 mark each. Questions 11 to 15 carry 2 marks each. For each question, four options are given. One of them is the correct answer. Make your choice (1, 2, 3 or 4). Shade the correct oval (1, 2, 3, or 4) on the Optical Answer Sheet.

(20 marks)

1. In 42.315, what does the digit 3 stand for?

- (1) 3 ones
- (2) 3 tenths
- (3) 3 hundreds
- (4) 3 thousandths

2. Which one of the following fractions is the smallest?

- (1) $\frac{1}{2}$
- (2) $\frac{2}{5}$
- (3) $\frac{3}{8}$
- (4) $\frac{4}{9}$

3. Express $6\frac{9}{12}$ as a decimal.

- (1) 6.129
- (2) 6.34
- (3) 6.75
- (4) 6.912

4. Part of a scale is shown below. What is the value indicated by the arrow?

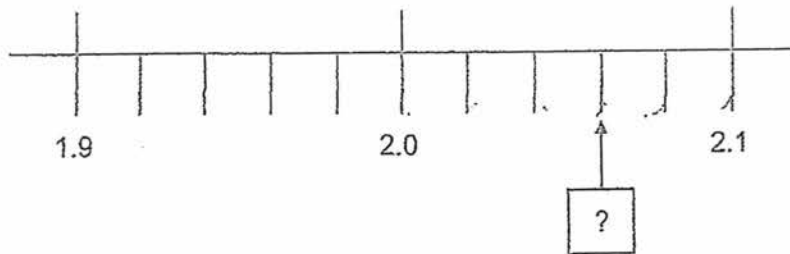

- (1) 2.003
(2) 2.006
(3) 2.03
(4) 2.06
5. A machine can pack $10j$ boxes of chocolates in 5 hours. At this rate, how many boxes of chocolates can it pack in 1 hour?
- (1) $5j$
(2) $2j$
(3) $15j$
(4) $50j$
6. Which one of the following would be the most likely length of a bed for an adult?
- (1) 1.9 cm
(2) 19 cm
(3) 1.9 m
(4) 19 m

7. Steven completed a puzzle in 132 seconds. He was 39 seconds faster than Thomas. How long did Thomas take to complete the puzzle?

- (1) 1 min 33 s
- (2) 1 min 55 s
- (3) 2 min 51 s
- (4) 3 min 25 s

8. The figure below shows a line DE and 4 points, L, M, N and P. Which point will form an angle greater than 45° but smaller than 90° at point E?

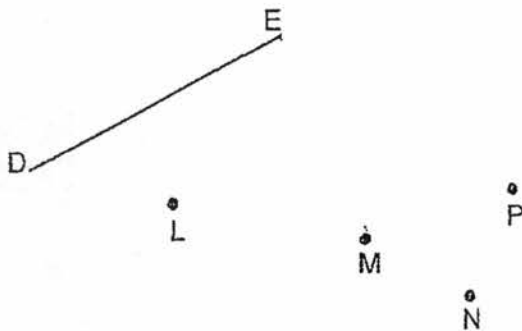

- (1) L
- (2) M
- (3) N
- (4) P

9. Which one of the following unit shapes cannot be tessellated?

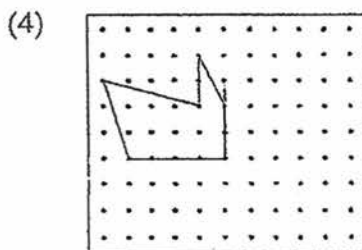
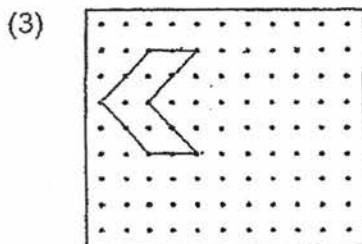
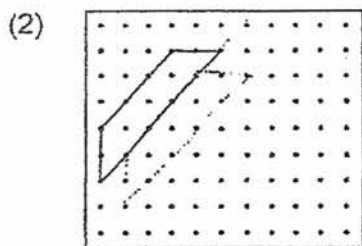
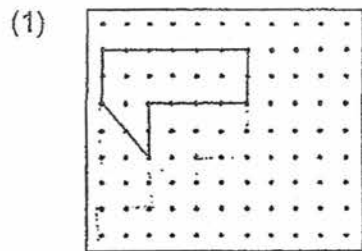

10. During a promotion, Tasty Bakery gave away a free pancake for every 4 pancakes purchased. What was the percentage discount offered during the promotion?

- (1) 20%
- (2) 25%
- (3) 75%
- (4) 80%

11. In the figure below, DBF is an equilateral triangle. ABF and ACE are straight lines. What is the difference between the marked angles, $\angle CED$ and $\angle BFD$?

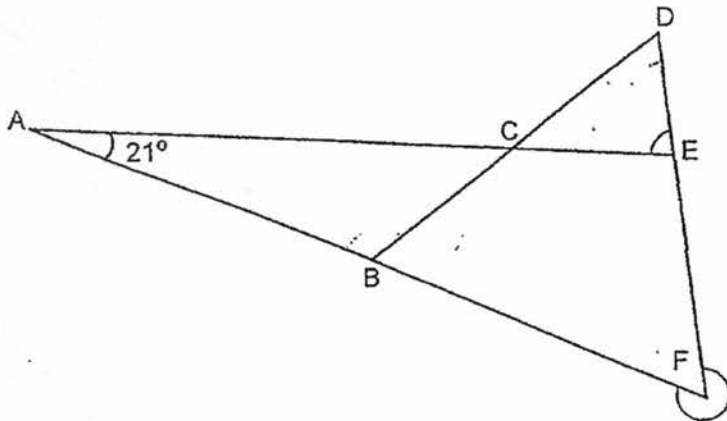

- (1) 300°
- (2) 261°
- (3) 219°
- (4) 180°

12. The table below shows the charges for bicycle rental.

Bicycle for Rent	
Deposit	\$40
Charges per 15 minutes	\$0.50

Chang wants to rent a bicycle for 3 hours. How much does he need to pay, including the deposit?

- (1) \$46
 - (2) \$42
 - (3) \$41.50
 - (4) \$40.50
13. The table below shows the number of 11-year-old and 12-year-old children in a horse-riding class. Some information is missing.

	11-year-old	12-year-old	Total
Boys	9	16	25
Girls			40
Total		48	

Based on the given information in the table, which one of the following statements is correct?

- (1) There are 17 girls who are 11 years old.
- (2) The total number of girls is fewer than the total number of boys.
- (3) The number of 11-year-old boys is 36% of the total number of boys.
- (4) The ratio of the number of 12-year-old girls to the number of 11-year-old girls is 1 : 4.

14. Mrs Tang bought some sugar. She used $\frac{1}{3}$ of the sugar on Monday and $\frac{2}{5}$ of it on Tuesday. The amount of sugar she had left was 132 g. How much sugar did Mrs Tang buy?

- (1) 220 g
- (2) 330 g
- (3) 363 g
- (4) 495 g

15. The figure below, not drawn to scale, shows a circle that is divided into 4 parts, A, B, C and D. Line XY is the diameter of the circle.

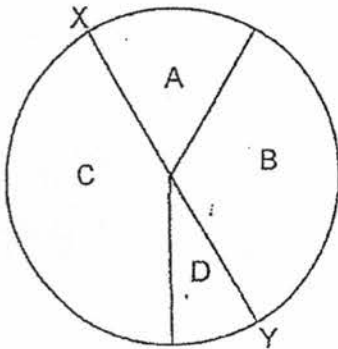

Area A is $\frac{1}{2}$ of Area B. Area C is 5 times of Area D. The area of A is 26 cm^2 . Find the area of C.

- (1) 13 cm^2
- (2) 52 cm^2
- (3) 65 cm^2
- (4) 130 cm^2

** END OF BOOKLET A**

Name : _____ ()

Class : Primary 6 _____

CHIJ ST NICHOLAS GIRLS' SCHOOL (PRIMARY)



Primary 6 Mathematics

2017 Preliminary Examination

Paper 1

Booklet B

22 AUGUST 2017

**15 questions
20 marks**

TOTAL TIME FOR BOOKLET A & B : 50 MINUTES

INSTRUCTIONS TO CANDIDATES

**DO NOT TURN OVER THIS PAGE UNTIL YOU ARE TOLD TO DO SO.
FOLLOW ALL INSTRUCTIONS CAREFULLY.
ANSWER ALL QUESTIONS.
WRITE YOUR ANSWERS IN THIS BOOKLET.
THE USE OF CALCULATORS IS NOT ALLOWED.**

This booklet consists of 10 printed pages including the cover page.

Questions 16 to 25 carry 1 mark each. Write your answers in the spaces provided. For questions which require units, give your answers in the units stated. (10 marks)

Do not write in this space

16. Given $e = 9$, find the value of $20e - 16e \div 4 + (e \times 5)$.

Ans : _____

17. The number of visitors to a tourist attraction last year was 212 000 when rounded off to the nearest thousand. What was the largest possible number of visitors to this tourist attraction last year?

Ans : _____

18. Using any two of the numbers in the box below, form the largest 2-digit number which is a multiple of 4.

6, 8, 9

Ans : _____



19. A train travelled 390 km at an average speed of 90 km/h. What was the time taken? Leave your answer as a mixed number in the simplest form.

Do not write in this space

Ans : _____ h

20. How many cubes are used to form this solid?

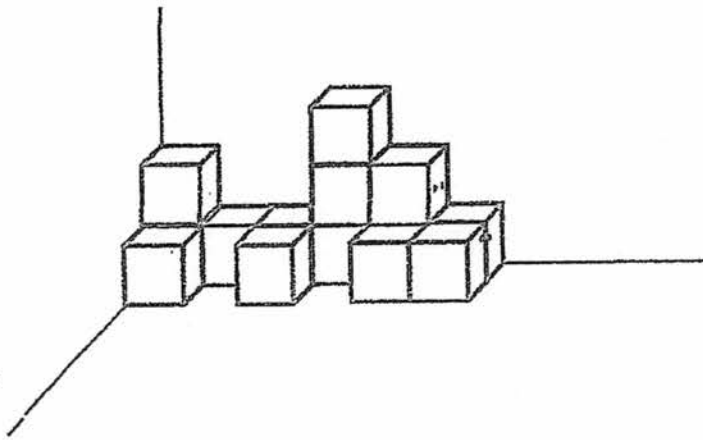

Ans : _____

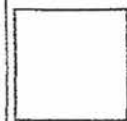

21. Find the area of the shaded triangle.

Do not write in this space

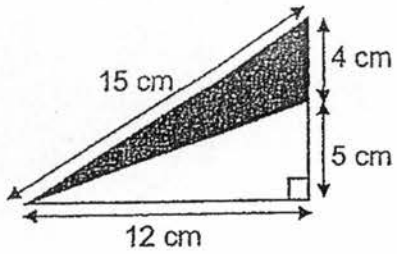

Ans : _____ cm²

22. In the figure below, which two squares should be removed to make line AB the line of symmetry? Shade the two squares.

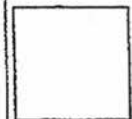
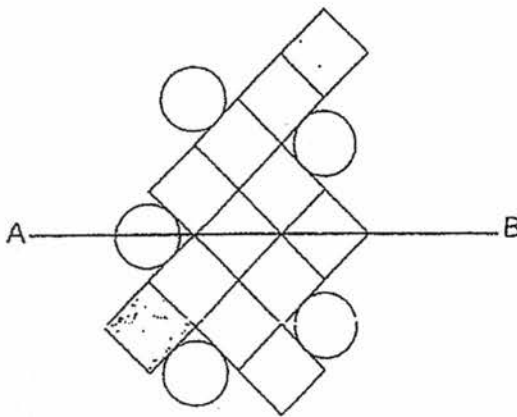

Use the information given below to answer questions 23 and 24.

During a class party, some games were played. Each game was played only once.

The table shows the number of games some children played during the class party.

Number of games played	0	1	2	3
Number of children	10	7	12	9

23. How many children played at least 1 game?

Ans : _____

24. The games lasted 15 minutes each. What was the longest time that one of these children could have been playing games?

Ans : _____ min

Do not
write in
this space

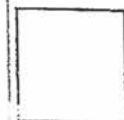

Use the information below to answer question 25.

The figure shows a park.

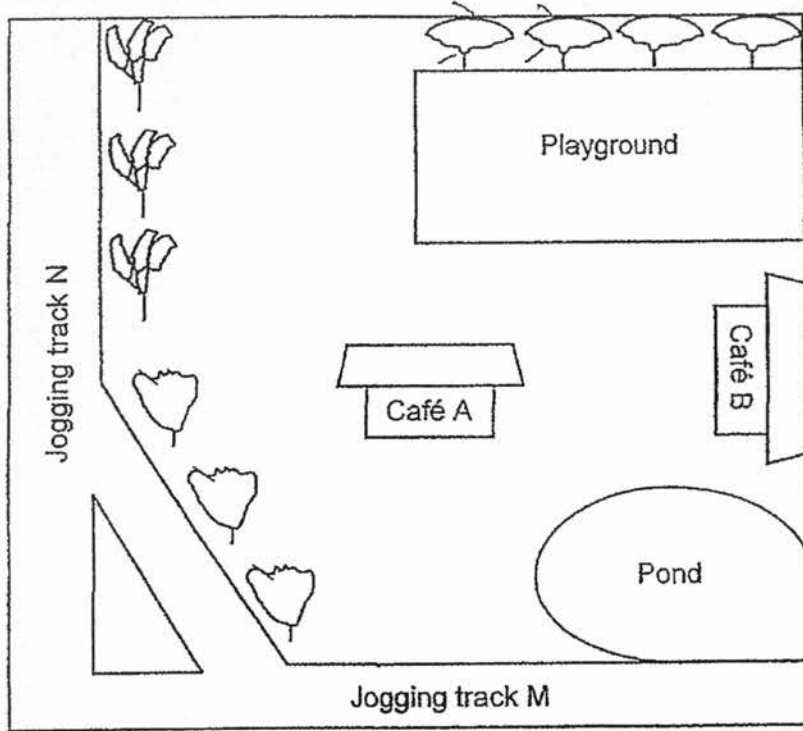

stands for a yellow flame tree



stands for a saga tree



stands for a rain tree

25. Which type of trees, yellow flame trees, saga trees or rain trees, forms a line parallel to jogging track M?

Ans : _____

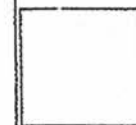

Do not
write in
this space

Questions 26 to 30 carry 2 marks each. Show your working clearly and write your answers in the spaces provided. For questions which require units, give your answers in the units stated. (10 marks)

Do not write in this space

26. The participants in a contest are Primary 5 and Primary 6 pupils in the ratio 7 : 6. All the Primary 5 participants are boys. Among the Primary 6 participants, the ratio of the number of girls to the number of boys is 2 : 3. What fraction of the total number of Primary 5 and Primary 6 participants are boys?

Ans : _____

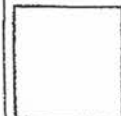

27. A group of kindergarten children were asked to vote for their favourite food.

The bar graph below shows their choices.

The difference between the number of children who voted for the most popular food and the number of children who voted for the next most popular food was 30.

How many children voted for porridge as their favourite food?

Do not
write in
this
space

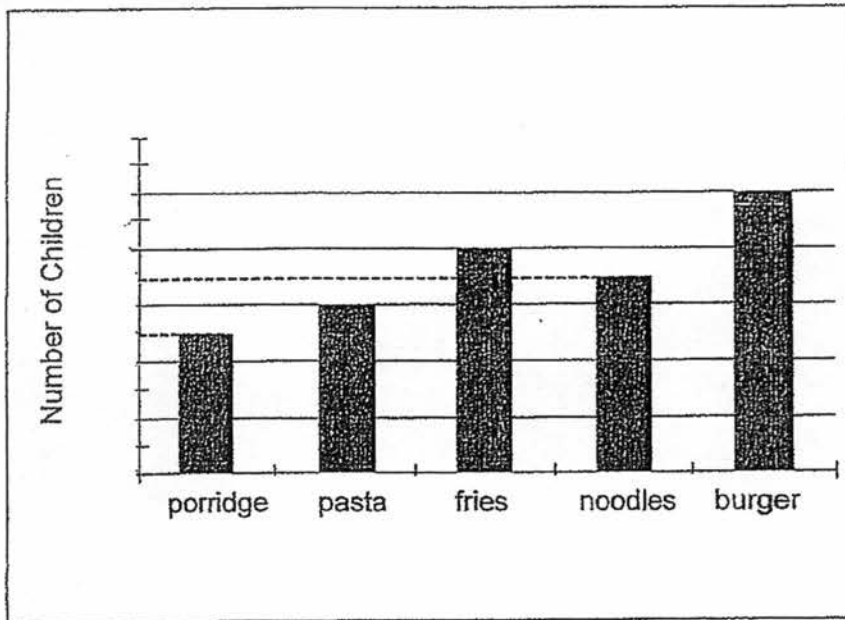

Ans : _____

28. Li Wen had two pieces of wire of the same length. She used one piece of wire to form an equilateral triangle of side 27 cm. She used the other piece of wire to form a square but had 17 cm of the wire left. What was the length of the square?

Do not write in this space

Ans : _____ cm

29. At first, on a bookshelf, $\frac{7}{10}$ of the books were non-fiction books and the rest were fiction books. $\frac{1}{3}$ of the fiction books and $\frac{1}{7}$ of the non-fiction books were removed. Twelve non-fiction books were removed. How many books were left on the bookshelf altogether?

Ans : _____



30. The figure below is made up of 3 big quadrants and 1 small quadrant. O is the centre of the circle and the diameter of the circle is 28 cm. Find the perimeter of the figure. (Take $\pi = \frac{22}{7}$)

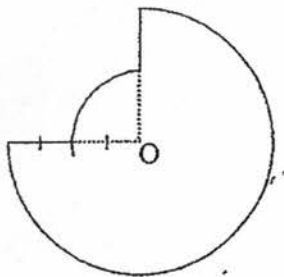

Do not
write
in this
space

Ans : _____ cm

**** END OF BOOKLET B****



Name : _____ ()

Class : Primary 6 _____

CHIJ ST NICHOLAS GIRLS' SCHOOL (PRIMARY)



Primary 6 Mathematics

2017 Preliminary Examination

Paper 2

22 AUGUST 2017

Parent's Signature

Paper 1	40
Paper 2	60
Total	100

18 QUESTIONS
60 MARKS

TOTAL TIME FOR PAPER 2 : 1 HOUR 40 MINUTES

INSTRUCTIONS TO CANDIDATES

DO NOT TURN OVER THIS PAGE UNTIL YOU ARE TOLD TO DO SO.

FOLLOW ALL INSTRUCTIONS CAREFULLY.

ANSWER ALL QUESTIONS.

WRITE YOUR ANSWERS IN THIS BOOKLET.

THE USE OF AN APPROVED CALCULATOR IS EXPECTED, WHERE APPROPRIATE.

This booklet consists of 17 printed pages including the cover page.

Questions 1 to 5 carry 2 marks each. Show your working clearly and write your answers in the spaces provided. For questions which require units, give your answers in the units stated.

Do not write in this space

(10 marks)

1. Joon Kee wants to move from point A to point E. He can only move south or east along the grid lines. He also must not cross points B, C and D. The grid below shows one way Joon Kee can move from point A to point E.

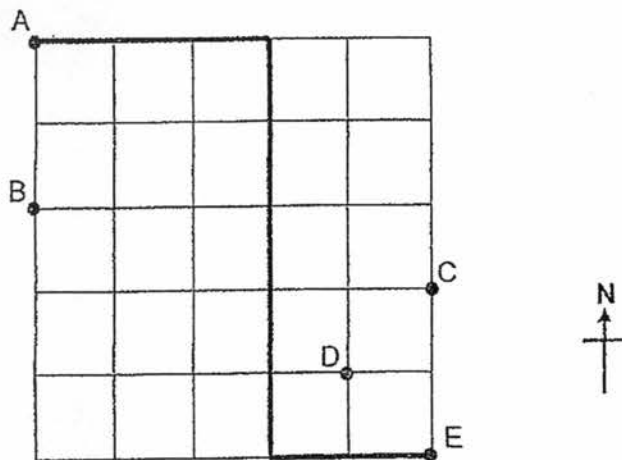

In each of the grids below, illustrate another two different ways that Joon Kee can move south or east from point A to point E, without crossing points B, C and D.

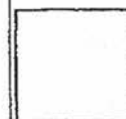
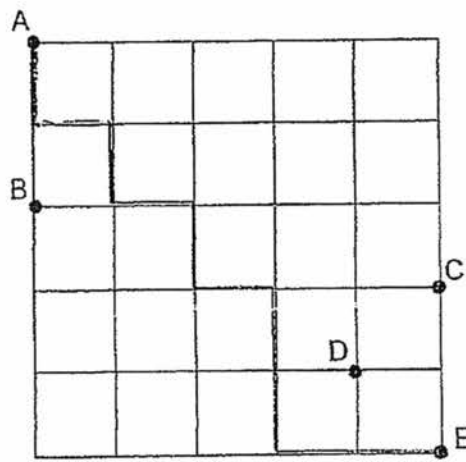
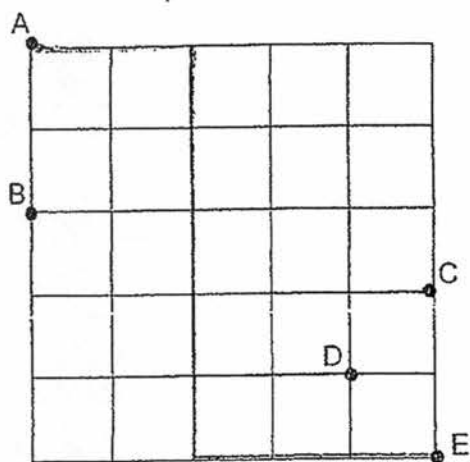

2. The mass of a pot was $(3 + 9r)$ kg. The mass of a flask was 3 kg less than the pot. Find the total mass of 1 such pot and 2 such flasks.

Do not
write
in this
space

Ans : _____ kg

3. Jenny had a bottle of 0.12ℓ of medicine. She was supposed to take an equal amount each day. She did not take the medicine on the 3rd day. At the end of the 5th day, she stopped taking the medicine. Half the bottle of medicine was left. How much medicine did Jenny take each day?

Ans : _____ ml

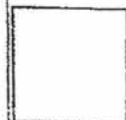

4. Tim wants to use triangular cards to cover a rectangular cardboard of length 36 cm and breadth 21 cm completely, with no overlapping. One such triangular card is shown below. What is the smallest number of such triangular cards needed to cover the rectangular cardboard completely?

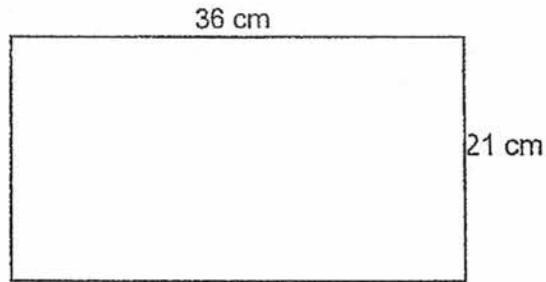
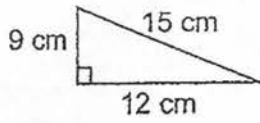

Do not write in this space.

Ans : _____

5. Almaz paid \$76.50 for some rings. Every ring cost the same. She also bought 5 bangles and paid \$35.90 for each of them. The average cost of the rings and the 5 bangles was \$32. How many rings did she buy?

Ans : _____



For questions 6 to 18, show your working clearly and write your answers in the spaces provided. The number of marks available is shown in brackets [] at the end of each question or part-question. (50 marks)

Do not write in this space

6. JK and JM are two sides of a parallelogram.

- (a) Complete the parallelogram JKLM by drawing the other two sides. Label the parallelogram.
- (b) Draw a line perpendicular to LK passing through point J.

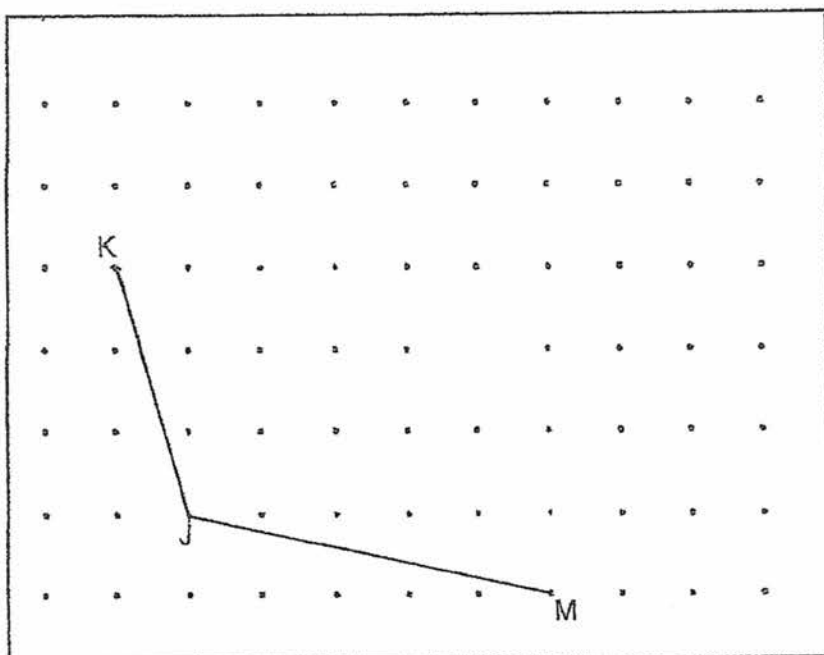

[3]

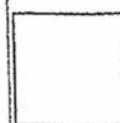

7. The pie chart shows the number of members in 4 CCAs in Respectful Primary School.

Do not write in this space

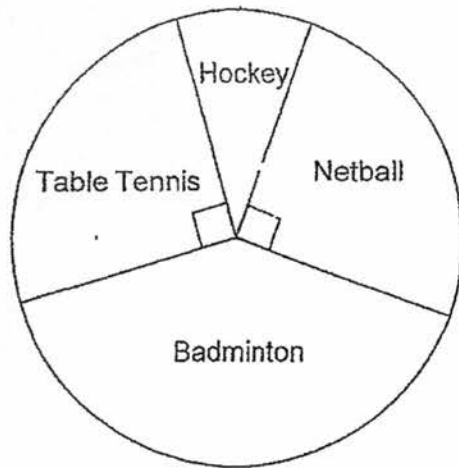

There are altogether 96 members in hockey and netball. The number of hockey members is 34 fewer than the number of table tennis members. How many members are there in badminton?

Ans : _____ [3]

8. A group of boys and girls went to an art exhibition. There were 180 girls at first. When $\frac{4}{5}$ of the boys and $\frac{2}{3}$ of the girls left the exhibition, the number of boys and girls who remained became 135. How many boys were there at first?

Do not
write
in this
space

Ans : _____ [3]

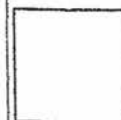

9. Container A and Container B were filled with some water as shown below. All the water from Container B was poured into Container A. In the end, Container A was filled to the brim. What was the height of Container A?

Do not write in this space

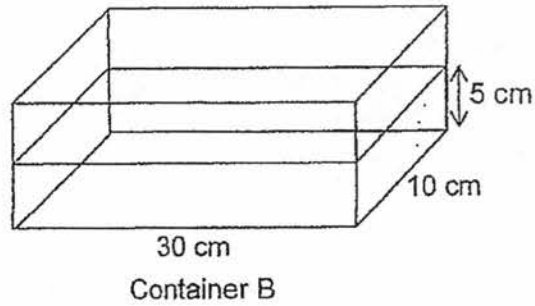
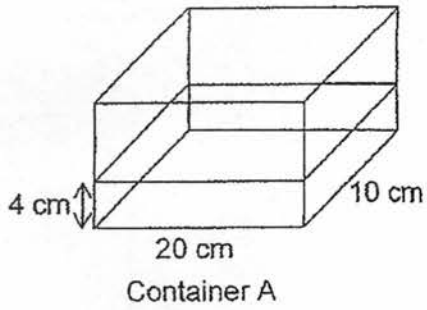

Ans : _____ [3]

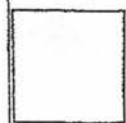

10. Cheryl had twice as many beads as Diana at first. Every day, Diana used 8 beads and Cheryl used 6 beads to make necklaces. When Diana had used all her beads, Cheryl still had 70 beads left. How many days did Diana take to use all her beads?

Do not
write
in
this
space

Ans : _____ [3]

11. The figure below is made up of a rectangle, PQRS and two quarter circles, PAS and PBQ. Find the area of the shaded part. (Take $\pi = 3.14$)

Do not write in this space

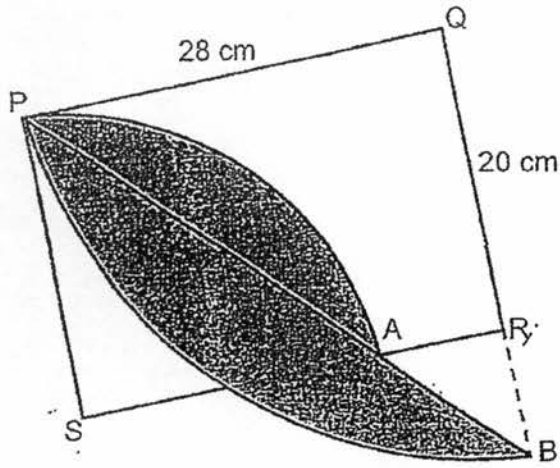

Ans : _____ [4]



- 12: Two brands of durians, Brand X and Brand Y, were sold at different prices as shown in the table below.

Do not
write
in
this
space

<i>Durians for Sale!</i>	
	
Brand	Price Per Durian
X	\$21
Y	\$9

The number of Brand Y durians sold was 3 times of the number of Brand X durians sold. The total amount of money collected from the sale of Brand X durians was \$612 less than the total amount of money collected from the sale of Brand Y durians. How many durians were sold altogether?

Ans : _____ [4]

13. David bought a bag of soil to do gardening. He kept $\frac{4}{9}$ of it for his own use. Then he scooped out 1.5 kg of the soil for his brother and $\frac{2}{7}$ of the remainder for his sister. He gave the rest to his mother. $\frac{1}{5}$ of his mother's share was 250 g. What was the mass of the bag of soil David bought?

Do not
write
in this
space

Ans : _____ [4]

14. The figure below shows Tank X and Tank Y placed together. Both the tanks were empty. Tank X is a cubical tank of base area 484 cm^2 . When some water was poured into Tank X, some of the water flowed into Tank Y through the hole which was just above Tank Y. In the end, Tank Y was $\frac{3}{8}$ filled and there was a total of 8217 ml of water in the two tanks. Find the capacity of Tank Y.

Do not write in this space

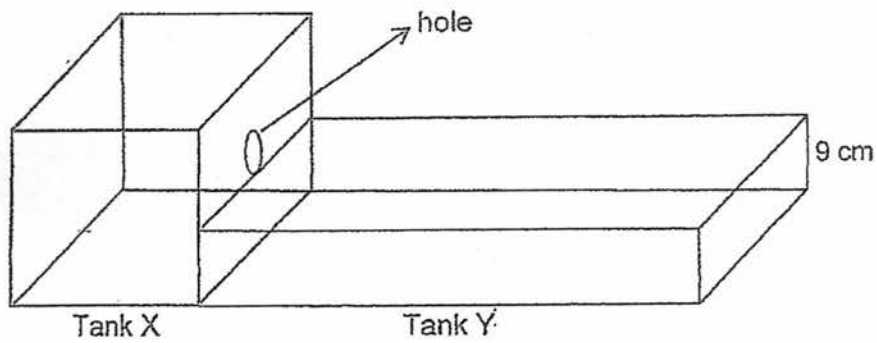

Ans : _____ [4]

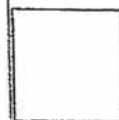

15. The figure below shows a rectangle PQRU. All the sides of XRSV are equal.

- (a) Name an isosceles triangle in XRSV.
- (b) $\angle QPX$ is 44° bigger than $\angle XPU$. Find $\angle XPU$.
- (c) Find $\angle PXV$.

Do not
write in
this
space

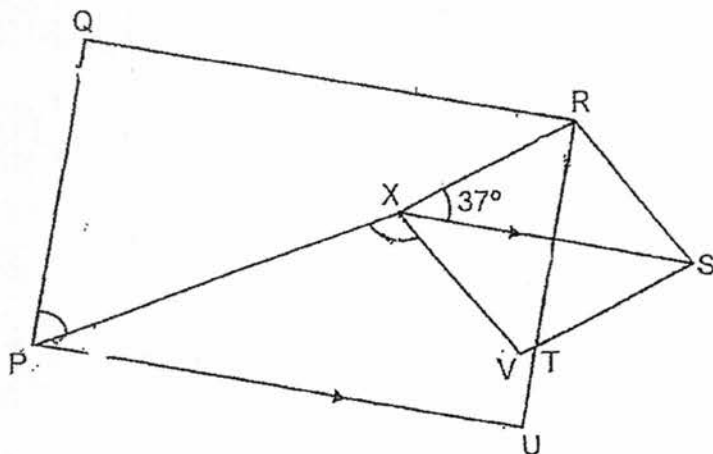

- Ans : (a) Triangle _____ [1]
 (b) _____ [2]
 (c) _____ [2]

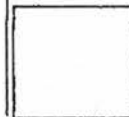

16. In 2015, the ratio of the number of men to the number of women who signed up for a marathon was 5 : 4. In 2016, the number of men decreased by 30% and the number of women increased by 50%. A total of 5225 men and women signed up for the marathon in 2016.

Do not
write in
this
space

- (a) Was there an overall increase or decrease in the total number of people who signed up for the marathon from 2015 to 2016?
- (b) What was the difference between the total number of people who signed up for the marathon in the two years?

Ans : (a) Overall _____ [2]

(b) _____ [2]

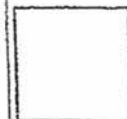

17. Mrs Bae left Town X at 11.35 a.m. and drove to Town Z.
For the first 67.5 km, she drove at an average speed of 90 km/h.
She stopped in Town Y for a short break of 20 min.
Then she drove the rest of the distance at an average speed of 80 km/h for 24 min.

- (a) Find the distance between Town Y and Town Z.
- (b) What time did Mrs Bae arrive at Town Z?

Do not
write in
this
space

Ans : (a) _____ [2]

(b) _____ [3]

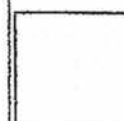

18. Tristan bought a football and two jerseys.
Beckam bought a football, a jersey and a helmet.
Tristan and Beckam bought the same type of football and jersey.
Tristan spent \$71 less than Beckam.
The cost of a jersey is \$54 more than the cost of a football.
The ratio of the cost of a football to the cost of a helmet is 1 : 6.
How much did Beckam spend on the football, the jersey and the helmet altogether?

Do not
write in
this
space

Ans : _____ [5]

****END OF PAPER****

YEAR : 2017
LEVEL : PRIMARY 6
SCHOOL : : CHIJ ST NICHOLAS GIRLS'
SUBJECT : : MATHEMATICS
TERM : PRELIMINARY EXAMINATION

Paper 1

Q1	2	Q4	4	Q7	3	Q10	1	Q13	3
Q2	3	Q5	2	Q8	2	Q11	3	Q14	4
Q3	3	Q6	3	Q9	4	Q12	1	Q15	3

Q16 189

Q17 212499

Q18 96

Q19 $4\frac{1}{3}h$

Q20 14

Q21 24 cm^2

Q22

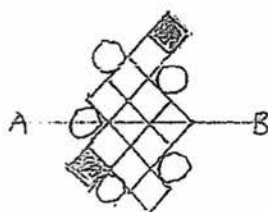

Q23 28 children

Q24 45 min

Q25 rain tree

Q26 $\frac{53}{65}$

Q27 75 children

Q28 16 cm

Q29 96 books

Q30 91 cm

Paper 2

Q1

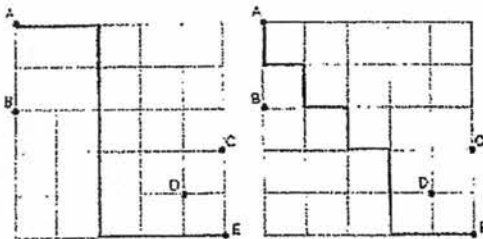

Q2 Pot: $(3 + 9r)$ kg
Flask: $(3 + 9r)$ kg $- 3$ kg = $(9r)$ kg
1 pot + 2 flask $\rightarrow (3 + 9r)$ kg + $(9r)$ kg + $(9r)$ kg \Rightarrow $(3 + 27r)$ kg

Q3 $0.120 \ell = 120$ ml
 $120 \text{ ml} \div 2 = 60$ ml
 $60 \text{ ml} \div 4 \Rightarrow$ 15 ml

Q4 Length of rectangle $\rightarrow 36 \div 9 = 4$
Breadth of rectangle $\rightarrow 21 \div 12 = 1R9$ (9 cm left)
Total no. of \triangle needed $\rightarrow (2 \times 4) + (3 \times 2) \Rightarrow$ 14 triangular cards

Q5 3 rings

CHEJ ST NICHOLAS PRELIM

Q6 (a & b)

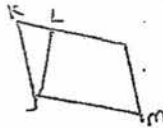

Q7 $96 - 34 = 62$
 Hockey $\rightarrow 62 \div 2 = 31$
 Netball $\rightarrow 31 + 34 = 65$
 $65 \times 4 = 260$
 $260 - 65 - 65 - 31 \Rightarrow \underline{99 \text{ members}}$

Q8 $\frac{1}{5}B + \frac{1}{3}G \rightarrow 135$

(x 3)

$\frac{3}{5}B + \frac{3}{3}G \rightarrow 135 \times 3 = 405$

$\frac{3}{5}B \rightarrow 405 - 180 = 225$

$75 \times 5 \Rightarrow \underline{375 \text{ boys}}$

Q9 Container B $\rightarrow 30 \times 10 \times 5 = 1500 \text{ cm}^3$
 $1500 \div (20 \times 10) = 7.5$
 $4 \times 7.5 \Rightarrow \underline{11.5 \text{ cm}}$

Q10 $8 - 3 = 5$
 5 units = 70
 1 unit = $70 \div 5 = 14$
 4 units = $14 \times 4 = 56$
 $56 \div 8 \Rightarrow \underline{7 \text{ days}}$

Q11 Total $\rightarrow 28 \times 20 = 560$
 PAS $\rightarrow \frac{1}{4} \times 3.14 \times 20 \times 20 = 314$
 $560 - 314 = 246$
 PBQ $\rightarrow \frac{1}{4} \times 3.14 \times 28 \times 28 = 615.44$
 $28 - 20 = 8$
 $\frac{1}{2} \times 8 \times 8 = 32$
 $615.44 - 246 - 32 \Rightarrow \underline{337.44 \text{ cm}^2}$

Q12 3 units $\times 9 = 27\text{u}$
 1 unit $\times 21 = 21 \text{ units}$
 $27 \text{ units} - 21 \text{ units} = 6 \text{ units} \rightarrow 612$
 1 unit $\rightarrow 612 \div 6 = 102$
 4 units $\rightarrow 102 \times 4 \Rightarrow \underline{408 \text{ durians}}$

Q13 1.5 kg = 1500 g
 $250 \times 7 = 1750$
 $1750 + 1500 = 3250$
 $3250 \times \frac{9}{5} \Rightarrow \underline{5850 \text{ g}}$

Q14 Capacity of X $\rightarrow 22 \times 22 \times 22 = 10648$
 $484 \times 9 = 4356$
 $8217 - 4356 = 3861$
 $3861 \div 3 = 1287$
 $1287 \times 8 \Rightarrow \underline{10296 \text{ ml}}$

Q15 (a) Triangle XRS
 (b) $\angle XPU \rightarrow (90^\circ - 44^\circ) \div 2 \Rightarrow \underline{23^\circ}$
 (c) $\angle SXV = \angle RXS = 37^\circ$
 $\angle PXV = 180^\circ - 23^\circ - 37^\circ \Rightarrow \underline{120^\circ}$

CHIJ ST NICHOLAS PRELIM

Q16 (a) Overall increase

(b) $30\% \rightarrow \frac{3}{10}$

$$8 \div 2 = 4$$

$$12 + 7 = 19$$

$$5225 \div 19 = 275$$

$$10 + 8 = 18$$

$$275 \times 18 = 4950$$

$$5225 - 4950 \Rightarrow \underline{275}$$

Q17 (a) $67.5 \div 90 = \frac{3}{4}$

$$\frac{3}{4} \times 60 = 45$$

$$80 \times \frac{24}{60} \Rightarrow \underline{32 \text{ km}}$$

(b) 1:04 pm

Q18 1 ball \rightarrow 1 unit

Jersey $\rightarrow 1u + 54$

Helmet $\rightarrow 1u + 54 + 71$

$$6 - 1 = 5$$

$$5 \text{ units} = 54 + 71 = 125$$

$$1 \text{ unit} = 125 \div 5 = 25$$

$$(25 \times 3) + (54 \times 2) + 71 \Rightarrow \underline{\$254}$$

