

Index number:

|  |  |  |  |  |  |  |  |  |  |
|--|--|--|--|--|--|--|--|--|--|
|  |  |  |  |  |  |  |  |  |  |
|--|--|--|--|--|--|--|--|--|--|

SINGAPORE CHINESE GIRLS' SCHOOL

PRELIMINARY EXAMINATION 2016

PRIMARY 6

MATHEMATICS  
PAPER 1

BOOKLET A

Name : \_\_\_\_\_ ( )

Class : Primary 6

|                    |           | Marks attained | Max Mark   |
|--------------------|-----------|----------------|------------|
| Paper 1            | Booklet A |                | <b>20</b>  |
|                    | Booklet B |                | <b>20</b>  |
| Paper 2            |           |                | <b>60</b>  |
| <b>Total Marks</b> |           |                | <b>100</b> |

|                    |
|--------------------|
| Parent's Signature |
|                    |

15 Questions  
20 Marks

Total Time for Booklets A and B: 50 min

**INSTRUCTIONS TO CANDIDATES**

Do not open this booklet until you are told to do so.

Follow all instructions carefully.

Answer all questions.

You are **not allowed** to use a calculator

6. A rectangle of length 6 cm has an area of  $78 \text{ cm}^2$ . What is its breadth?

- (1) 6.5 cm
- (2) 13 cm
- (3) 19.5 cm
- (4) 33 cm

7. The graph below shows the average temperature from Monday to Sunday. From which day to which day was there the greatest drop in temperature?

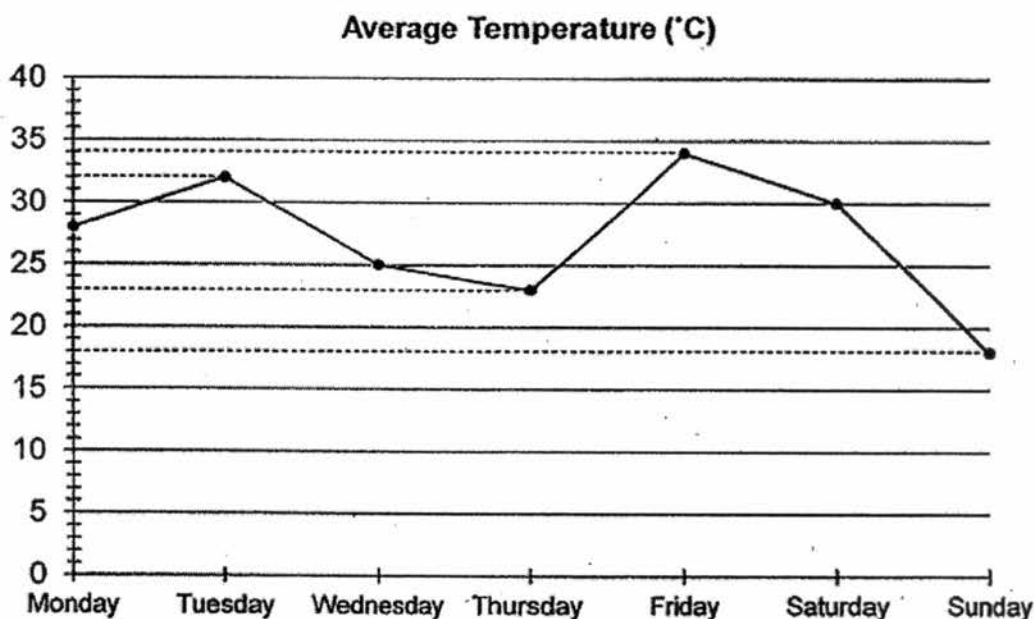

- (1) Tuesday to Wednesday
- (2) Thursday to Friday
- (3) Friday to Saturday
- (4) Saturday to Sunday

8. Andy, Billy and Charlie shared a sum of money in the ratio of 3 : 5 : 4. What is the difference in the amount Andy and Billy had when Charlie had \$50?

- (1) \$12.50
- (2) \$25
- (3) \$50
- (4) \$75

**Booklet A**

Questions 1 to 10 carry 1 mark each. Questions 11 to 15 carry 2 marks each. For each question, four options are given. One of them is the correct answer. Make your choice (1, 2, 3 or 4). Shade the correct oval (1, 2, 3 or 4) on the Optical Answer Sheet. **(20 marks)**

---

1. What is the value of the digit '1' in 3 406 125?

- (1) 100
- (2) 1000
- (3) 10 000
- (4) 100 000

2. Find the value of  $20 - (15 - 5) \div 5 \times 2$ .

- (1) 1
- (2) 16
- (3) 3
- (4) 19

3. Express 700 g in kilograms.

- (1) 0.007 kg
- (2) 0.07 kg
- (3) 0.7 kg
- (4) 7 kg

4. What is  $2.404 \times 3$  rounded off to the nearest 2 decimal places?

- (1) 7.20
- (2) 7.21
- (3) 7.22
- (4) 7.24

5. What is the lowest common multiple of 6 and 8?

- (1) 1
- (2) 2
- (3) 24
- (4) 48

9. Mrs. Poon baked  $7y$  cookies and gave 15 cookies to each of her children. How many children does she have if she has  $3y$  cookies left?

- (1)  $\frac{4y}{15}$   
(2)  $\frac{15}{4y}$   
(3)  $\frac{3y}{7y-15}$   
(4)  $\frac{7y-15}{3y}$

10. Triangle ABC below is an equilateral triangle. Find the value of  $\angle x$ .

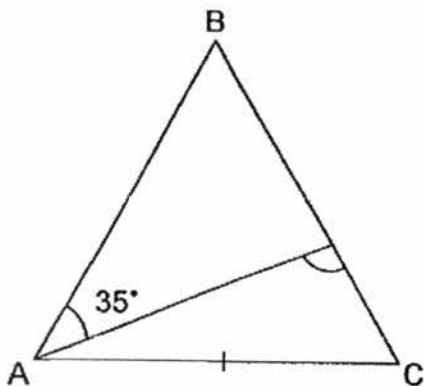

- (1)  $25^\circ$   
(2)  $75^\circ$   
(3)  $85^\circ$   
(4)  $95^\circ$
11. A piece of string is cut into two pieces, which are used to form two squares. The sum of the areas of the two squares is  $45 \text{ cm}^2$ . The length of the smaller square is 3 cm. What is the length of the bigger square?
- (1) 4.5 cm  
(2) 6 cm  
(3) 3 cm  
(4) 9 cm

12. Which of the following shows the net of the solid below?

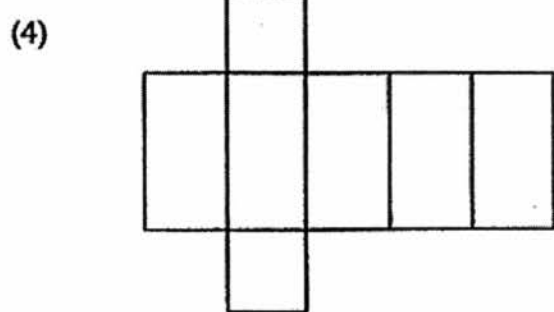
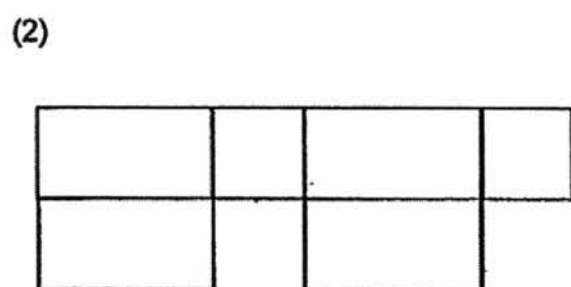
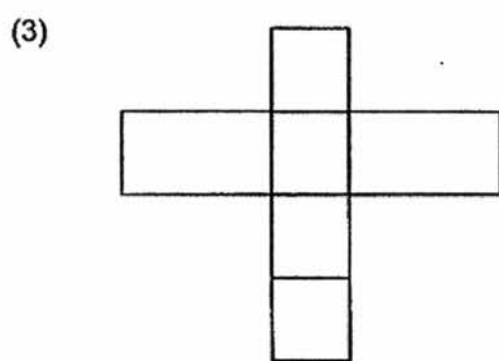
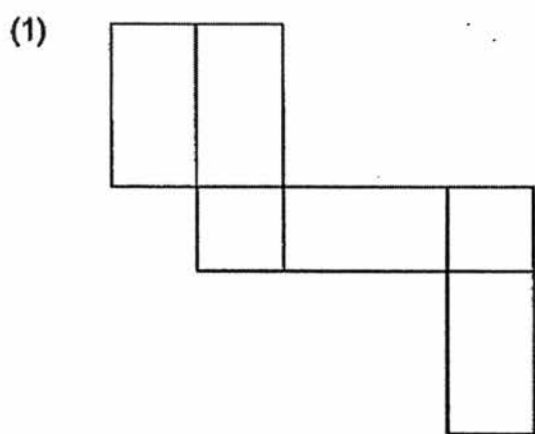
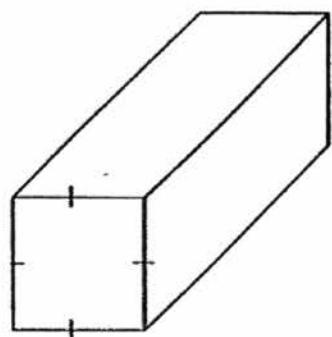

13. The ratio of the length to the breadth of a rectangular cardboard is 5 : 2 .  
Given that the sum of all sides of the cardboard is 70 cm, find its  
breadth.

- (1) 5 cm
- (2) 10 cm
- (3) 20 cm
- (4) 50 cm

14. Sally left Singapore for Philippines and arrived at 3.05 a.m. What time  
did she depart from Singapore if the journey was  $3\frac{1}{2}$  hours long?

- (1) 11.25 p.m.
- (2) 11.35 p.m.
- (3) 12.25 p.m.
- (4) 12.35 p.m.

15. The figure below is made up of a square, a quadrant and a circle. The  
length of the square is 14 cm. Find the perimeter of the shaded portion  
of the figure. (Take  $\pi = \frac{22}{7}$ )

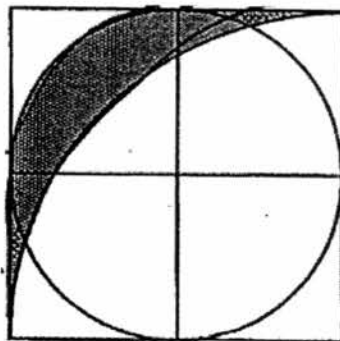

- (1)  $16\frac{1}{2}$  cm
- (2)  $30\frac{1}{2}$  cm
- (3) 33 cm
- (4) 47 cm

-End of booklet A-

Index number:      -

SINGAPORE CHINESE GIRLS' SCHOOL

PRELIMINARY EXAMINATION 2016

PRIMARY 6

MATHEMATICS

PAPER 1

BOOKLET B

Name : \_\_\_\_\_ ( )

Class : Primary 6 SYIC/GISEIP

| Paper 1   | Mark attained | Max Mark |
|-----------|---------------|----------|
| Booklet B |               | 20       |

15 Questions  
20 Marks

Total Time for Booklets A and B: 50 min

**INSTRUCTIONS TO CANDIDATES**

Do not open this booklet until you are told to do so.

Follow all instructions carefully.

Answer all questions.

You are **not allowed** to use a calculator

**Booklet B**

Do not write in  
this column

Name: \_\_\_\_\_ ( ) Class: P6 SY/C/G/SE/P

Questions 16 to 25 carry 1 mark each. Write your answers in the spaces provided.  
For questions which require units, give your answers in the units stated. (10marks)

16. What is the ratio of 80 m to 2 km in the simplest form?

Ans: \_\_\_\_\_

17. What is  $\frac{3}{4} \times \frac{2}{9}$  expressed in the simplest form?

Ans: \_\_\_\_\_

18. Find 80% of \$50.

Ans: \$ \_\_\_\_\_

19. Natasha is 12 years old. Tanya is  $2p$  years younger than her. What is Tanya's age in 3 years' time? (Give your answer in terms of  $p$ )

Ans: \_\_\_\_\_ years

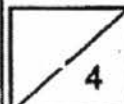



20. Uncle Leong sold 4 fishes and 2 kg of flour for \$23. How much does 1 kg of flour cost if each fish costs \$4?

Do not write in this column

Ans: \$ \_\_\_\_\_

21. There are two rows of houses along a street. The houses are numbered 1, 2, 3 and so forth, up one side and then back down the other side. Unit number 4 is opposite unit number 19. What unit number is opposite unit 9?

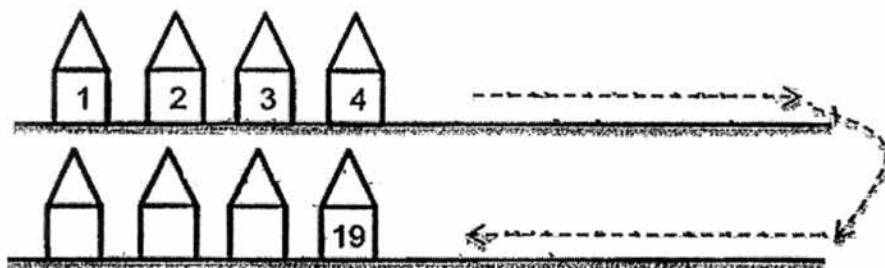

Ans: \_\_\_\_\_

22. Find the area of a semi-circle with a diameter of 20 cm. (Take  $\pi$  as 3.14)

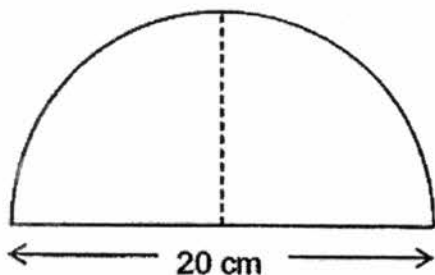

Ans: \_\_\_\_\_  $\text{cm}^2$

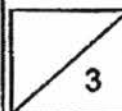

23. The length of a piece of string is 1.2 m. Mary uses 24 cm of the string to tie a parcel. She then cuts the remainder into 3 equal pieces. What is the length of each of the remainder shorter piece of string?

Do not write in  
this column.

Ans: \_\_\_\_\_ cm

24. Lines AB and CD are parallel. Find the value of  $\angle ABC$ .

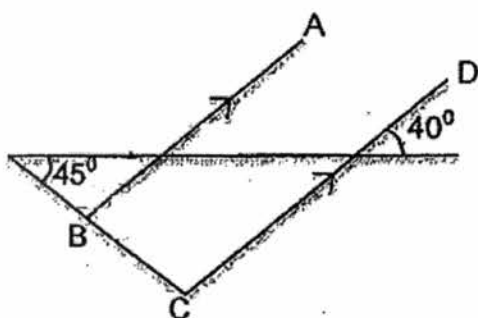

Ans: \_\_\_\_\_

25. Drake jogged 2 km in 15 minutes. What is his speed in km/h?

Ans: \_\_\_\_\_ km/h

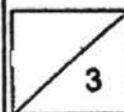

Questions 26 to 30 carry 2 marks each. Show your working clearly in the space for each question and write your answers in the spaces provided. For questions that require units, give your answers in the units stated. (10 marks)

Do not write in this column

26. Jamie has 4 kg of rice. She gave  $\frac{1}{6}$  kg to her aunt and  $\frac{3}{4}$  of it to her cousin. How much rice does she have left?

Ans: \_\_\_\_\_ kg

27. A rectangular tank measuring 30 cm long, 12 cm wide and 20 cm high is filled with 2.3 l of water. How many more millilitres of water must be added to the tank such that it will be  $\frac{2}{3}$  full?

Ans: \_\_\_\_\_ ml

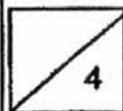

28. Sally recorded her scores for her exams as shown below. How much did she score for Science?

Do not write in  
this column

|       | English | Math | Science | Average |
|-------|---------|------|---------|---------|
| Score | 86      | 67   | 7       | 76      |

Ans: \_\_\_\_\_

29. Mrs Lim baked some muffins, cookies and shortbread. The number of muffins is  $\frac{1}{3}$  of the number of shortbread. There are 5 less cookies than shortbread. If there is a total of 135 muffins, cookies and shortbread, how many muffins did Mrs Lim bake?

Ans: \_\_\_\_\_

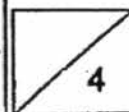

30. The figure below shows a square overlapping a rectangle. The ratio of the shaded area to the area of the rectangle is  $2 : 5$ . Given that the area of the square is  $\frac{2}{3}$  the area of the rectangle, find the ratio of the shaded area to the area of the square.

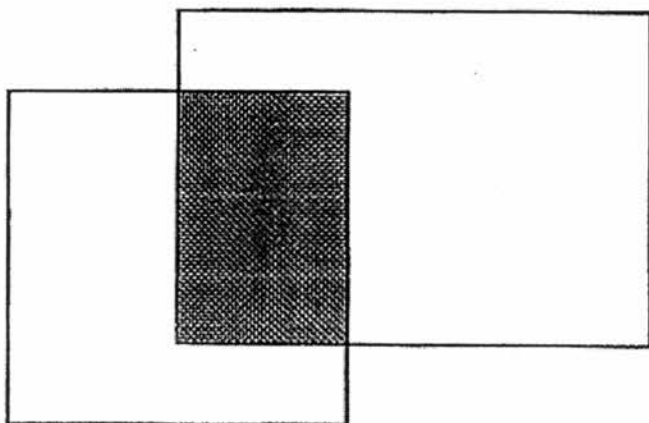

Do not write in  
this column

Ans: \_\_\_\_\_

-End of paper-  
Check your work thoroughly.

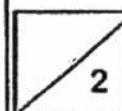

Index number:

|  |  |  |  |  |  |   |  |
|--|--|--|--|--|--|---|--|
|  |  |  |  |  |  | - |  |
|--|--|--|--|--|--|---|--|

SINGAPORE CHINESE GIRLS' SCHOOL

PRELIMINARY EXAMINATION 2016

PRIMARY 6

MATHEMATICS

PAPER 2

Name : \_\_\_\_\_ ( )

Class : Primary 6 SY/C/G/SE/P

|                | Mark | Max Mark  |
|----------------|------|-----------|
| <b>Paper 2</b> |      | <b>60</b> |

| Parent's Signature |
|--------------------|
|                    |

18 Questions  
60 Marks

Total Time For Paper 2: 1 h 40 min

**INSTRUCTIONS TO CANDIDATES**

Do not open this booklet until you are told to do so.

Follow all instructions carefully.

Answer all questions.

You are allowed to use the calculator

Questions 1 to 5 carry 2 marks each. Show your working clearly in the space below each question and write your answers in the space provided. For questions which require units, give your answers in the units stated. (10 marks)

Do not write in this column

1. Joelle and Katelyn shared some stickers in the ratio of 5 : 7. After Joelle gave Katelyn 12 stickers, the ratio became 1 : 5. How many stickers did they have altogether?

Ans: \_\_\_\_\_

2. Express 384 g as a percentage of 1.5 kg.

Ans: \_\_\_\_\_ %

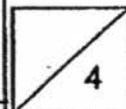

3. The figure below is made up of 2 similar 4-sided figures. Find the sum of  $\angle a + \angle b + \angle c$ .

Do not write in this column

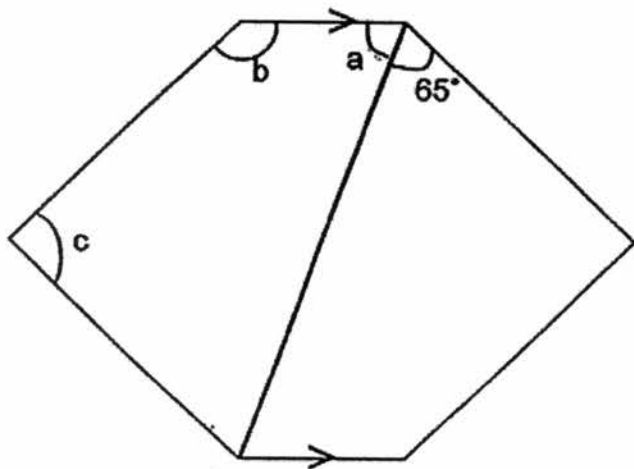

Ans: \_\_\_\_\_°

4. Jeremy can cycle 210 metres in 15 seconds while Mingde can cycle 150 metres within the same time. Given that they started at the same time in the same direction, how far apart were they after 30 seconds?

Ans: \_\_\_\_\_ m

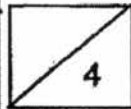



5. ABCD is a parallelogram. Construct a parallelogram by completing the figure. ABCD below.

Do not write in this column

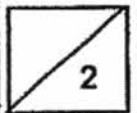
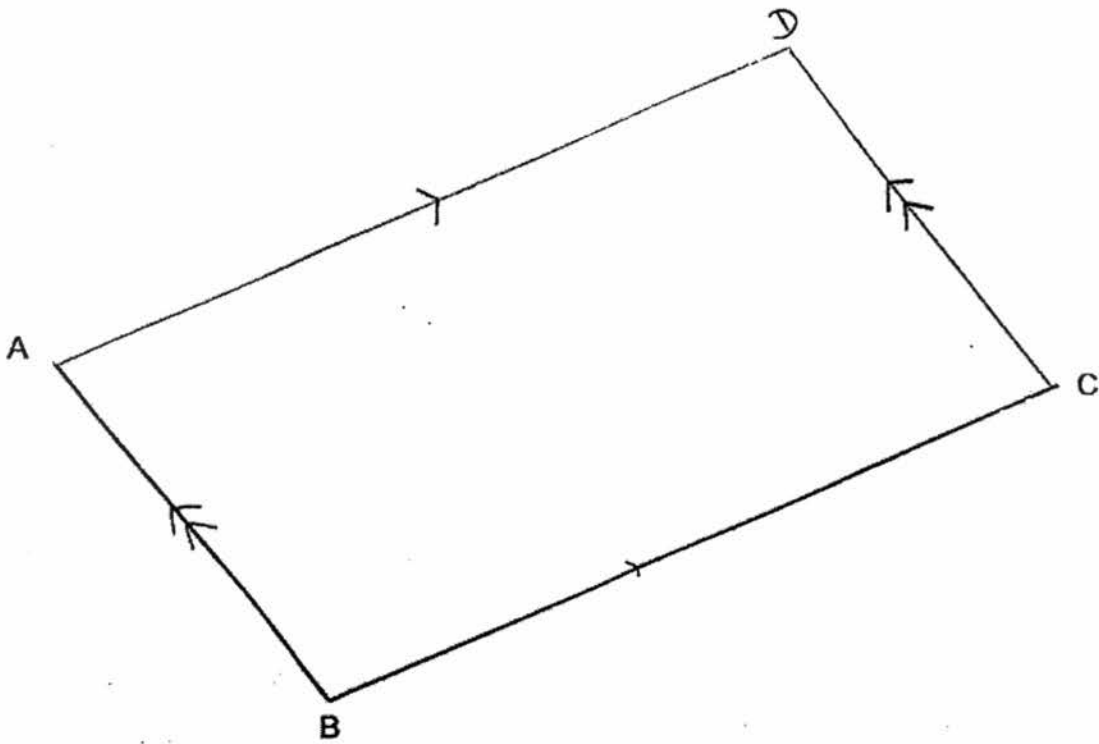

For questions 6 to 18, show your working clearly in the space below each question and write your answers in the spaces provided. The number of marks awarded is shown in brackets [ ] at the end of each question or part-question.

Do not write  
this column

(50 marks)

- 
6. Uncle Sam earns \$4500 per month. He gives his children \$1500, his wife 20% of his remaining salary and saves the rest. How much will his wife get if Uncle Sam gets a 10% pay raise?

Ans: \_\_\_\_\_ [ 3 ]

- 
7. The selling price of each cup of orange juice is  $\frac{3}{2}$  times as much as the selling price of a cup of apple juice. For every 2 cups of orange juice sold, Mr Lee sells 5 cups of apple juice. He earns \$12 more from apple juice than from orange juice. How much does Mr Lee earn altogether?

Ans: \_\_\_\_\_ [ 3 ]

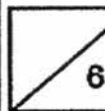

8. Some identical rectangular tiles are arranged to form a pattern as shown below. The length of each tile is 15 cm. Find the perimeter of the shaded parts.

Do not write in this column

← 15 cm →

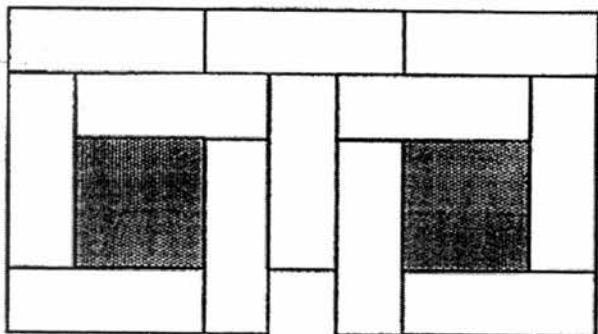

Ans: \_\_\_\_\_ [ 3 ]

9. Mrs Lim baked some cookies. She gave  $\frac{1}{4}$  of the cookies to her daughter,  $\frac{1}{3}$  of the cookies to her son, and  $\frac{1}{2}$  of the remaining cookies to her husband. Her husband received 3 cookies lesser than her son. How many cookies did she bake altogether?

Ans: \_\_\_\_\_ [ 3 ]

10. The figure below is made up of a square and a quadrant. Find the shaded area in terms of  $\pi$ .

Do not write  
this column

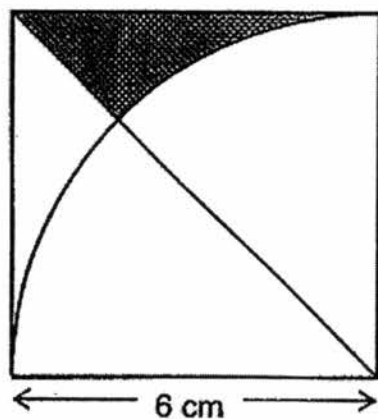

Ans: \_\_\_\_\_ [3]

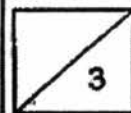

11. The running track below is made up of a rectangle of 300 m by 140 m and 2 semi-circles as shown below. Wayne took 80 minutes to jog 3 rounds around this track. What was Wayne's speed in km/h? (Take  $\pi$  as  $\frac{22}{7}$ )

Do not write  
this column

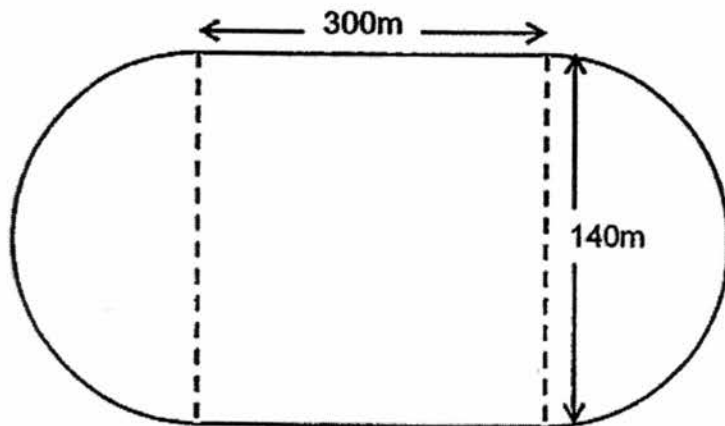

Ans: \_\_\_\_\_ [ 4 ]



12. The figure below shows a rectangle ABCD. The length CE is  $\frac{3}{4}$  of the length of DC, the area of triangle CEF is  $24\text{cm}^2$  and the area of triangle CEF is  $\frac{1}{2}$  of triangle ABF.

- a) Find the area of triangle CDF.  
b) Find the area of rectangle ABCD.

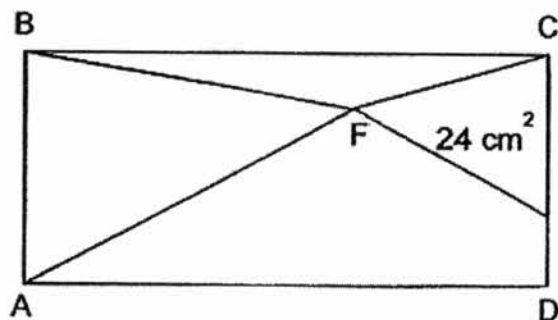

Do not write in  
this column

Ans: a) \_\_\_\_\_ [2]

b) \_\_\_\_\_ [2]

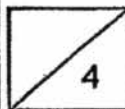

13. For a science quiz, 2 marks are awarded for every correct answer and 1 mark is deducted for every wrong answer. Peter got  $\frac{1}{6}$  of the quiz wrong. How many questions are there in the quiz if Peter scored 90 marks?

Do not write  
this column

Ans: \_\_\_\_\_ [4]

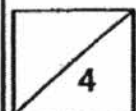

14. The pie chart below, not drawn to scale, shows how SCGS Primary 6 pupils travel to school every day. There are  $\frac{3}{8}$  as many pupils taking the bus as pupils taking the car to school. Half of the pupils cycle, walk or take the bus to school. Find the total number of Primary 6 pupils in SCGS.

Do not write  
this column

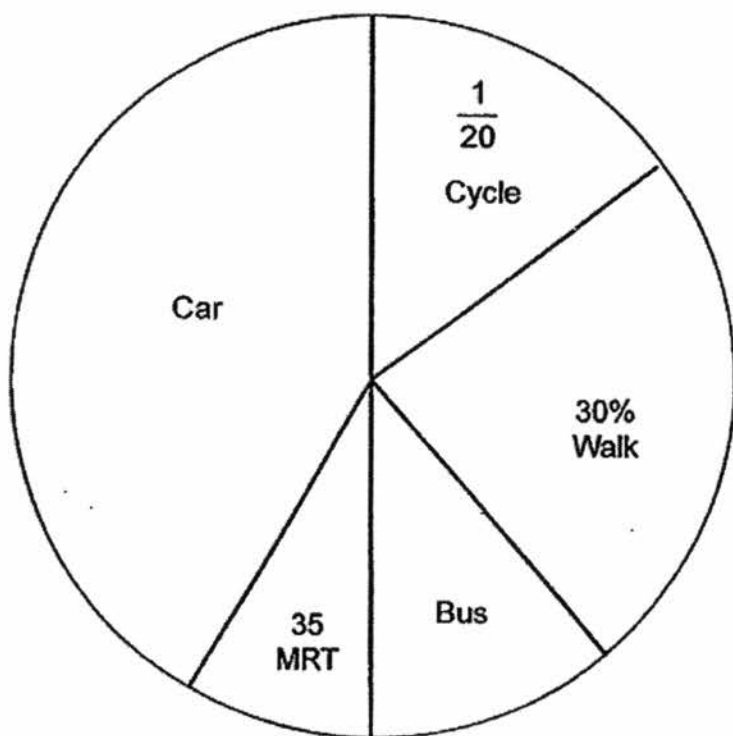

Ans: \_\_\_\_\_ [ 4 ]

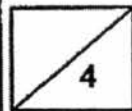



15. Shop A sells pencils at \$0.80 each and \$2 for a bundle of 4.
- a) What is the percentage discount if you the buy the pencils in bundle?
  - b) Mr Poh bought 11 pencils. What is the minimum amount Mr Poh has to pay for the pencils?

Do not write  
this column

Ans: a) \_\_\_\_\_ [ 2 ]

b) \_\_\_\_\_ [ 2 ]

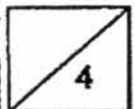

16. Mrs Cheng sells stickers. She sold 40% more stickers in April than in May..She sold 20% fewer stickers in May than in June. Mrs Cheng sold 150 fewer stickers in May than in June. Find the total number of stickers that Mrs Cheng sold for the 3 months.

Do not write  
in this column

Ans: \_\_\_\_\_ [5]

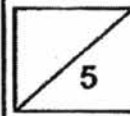

Do not write  
this column

17. Tap A was turned on to fill an empty tank at  $300 \text{ cm}^3$  per min. After 5 minutes, Tap B was turned on to fill the tank at a rate of  $120 \text{ cm}^3$  per min while Tap C emptied the tank at  $455 \text{ cm}^3$  per min. Given that the tank has a square base of  $10 \text{ cm}$ , what is the height of the water in the tank after Tap B and Tap C have been turned on for 15 minutes?

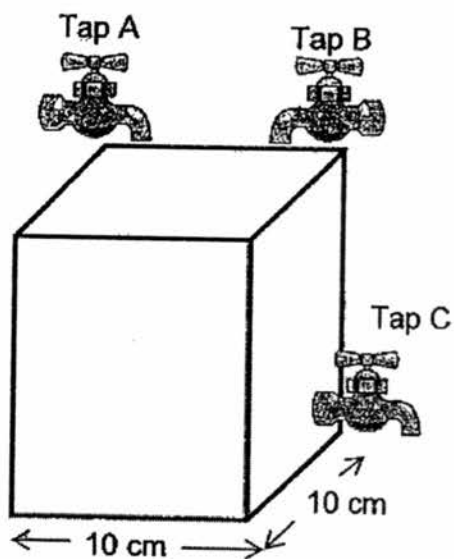

Ans: \_\_\_\_\_ [ 5 ]

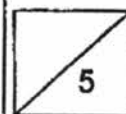

18. Pauline sells a packet of popcorn at \$2.50 each and a packet of candy floss at \$1.80 each. After selling for a day, she earned \$2.10 more from the sale of candy floss than the sale of popcorns. She sold 14 more packets of candy floss than popcorns.
- a) How many packets of popcorn did she sell?
  - b) How much did she earn from selling candy floss?

Ans: a) \_\_\_\_\_ [3]

b) \_\_\_\_\_ [2]

---

-End of paper-  
Check your work thoroughly.

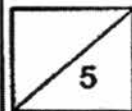

EXAM PAPER 2016

SCHOOL : SCGS

SUBJECT : MATHEMATICS

TERM : SA2

|     |     |     |     |     |    |    |    |    |     |
|-----|-----|-----|-----|-----|----|----|----|----|-----|
| Q1  | Q2  | Q3  | Q4  | Q5  | Q6 | Q7 | Q8 | Q9 | Q10 |
| 1   | 2   | 3   | 2   | 3   | 2  | 4  | 2  | 1  | 4   |
| Q11 | Q12 | Q13 | Q14 | Q15 |    |    |    |    |     |
| 2   | 1   | 2   | 2   | 4   |    |    |    |    |     |

16)  $1 : 25$

17)  $1/6$

18)  $\$40$

19)  $(15 - 2p)$

20)  $\$35$

21)  $14$

22)  $157 \text{ cm}^2$

23)  $32 \text{ cm}$

24)  $85^\circ$

25)  $8 \text{ km/h}$

26)  $4 \times \frac{3}{4} = 3\text{kg}$

28)  $76 \times 3 = 228$

$4\text{kg} - 3\text{kg} = 1\text{kg}$

$228 - 86 = 142$

$1 - 1/6 = 5/6$

Ans : 77

27)  $2.3\text{L} = 2300\text{ml}$

29)  $7u = 135 + 5 = 140$

$30 \times 12 \times 20 = 7200$

$1u = 140 \div 7 = 20$

$7200 \div 3 = 2400$

30)  $\text{SH} : \text{R} : \text{S}$

$\text{SH} : \text{S}$

$2400 \times 2 = 4800$

$2 : 5$

$6 : 10$

$4800 - 2300 = 2500 \text{ ml}$

$= 6 : 15 : 10$

$= 3 : 5$

**PRELIMINARY EXAM PAPER 2016**

**SCHOOL : SINGAPORE CHINESE GIRLS'S SCHOOL**  
**SUBJECT : MATHEMATICS**  
**TERM : PRELIMINARY EXAMINATION 2016**

**PAPER 2**

**Q1 WORKING**

J: K

5U: 7U

-12 +12

2U: 10U 12 U

3U ————12

Total: ———— $\frac{12}{3} \times 12 = 48$

**Answer: 48 stickers**

**Q2 WORKING**

1.5kg = 1500g

Percentage ———— $\frac{384g}{1500g} \times 100\% = 25.6\%$

**Answer: 25.6%**

**Q3 WORKING**

a + b + c ————  $360 - 65 = 295^\circ$

**Answer: 295°**

**Q4 WORKING**

J, speed ————  $210m \div 15s = 14m/s$

M, speed ————  $150m \div 15s = 10m/s$

Diff in speed ————  $14m/s - 10m/s = 4m/s$

Distance apart ————  $4m/s \times 30s = 120m$

**Answer: 120m**

### Q5 WORKING

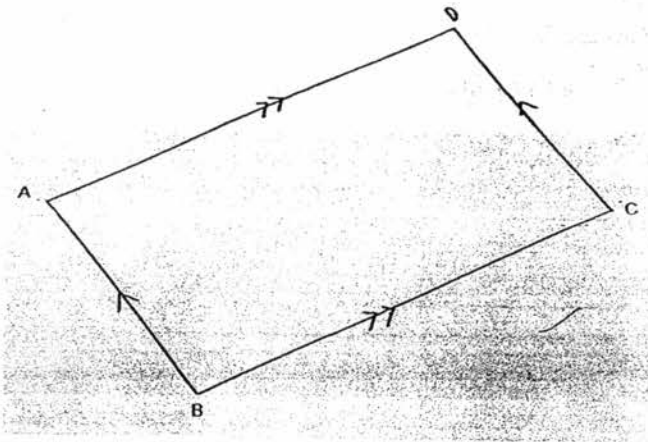

### Q6 WORKING

$$\text{New salary} \text{ --- } \frac{\$4500}{100} \times 110 = \$4950$$

$$\text{Wife + save} \text{ --- } \$4950 - \$1500 = \$3450$$

$$\text{Wife} \text{ --- } \frac{\$3450}{100} \times 20 = \$690$$

**Answer: \$690**

### Q7 WORKING

Juice no. X value = Total value

Orange 2 X value = 6u

Apple 5 X value = 10u

$$10u - 6u = 4u$$

$$4u \text{ --- } \$12$$

$$\text{Total} \text{ --- } \frac{\$12}{4} \times (10 + 6) = \$48$$

**Answer: \$48**

**Q8 WORKING**

$$1L = 3B$$

$$1B = \frac{15\text{cm}}{3} = 5\text{cm}$$

$$1 \text{ shaded} = (1L - 1B) \times 4 \\ = (15\text{cm} - 5\text{cm}) \times 4$$

$$2 \text{ shaded} = 40\text{cm} \times 2 = 80\text{cm}$$

**Answer: 80cm**

**Q9 WORKING**

$$D = \frac{1}{4} = \frac{3}{12}$$

$$S = \frac{1}{3} = \frac{4}{12} = \frac{8}{24}$$

$$\text{Left} = 1 - \frac{4}{12} - \frac{3}{12} = \frac{5}{12}$$

$$H = \frac{1}{2} \times \frac{5}{12} = \frac{5}{24}$$

$$\frac{8}{24} - \frac{5}{24} = \frac{3}{24}$$

$$\frac{3}{24} \text{ of total} = 3$$

$$\text{Total} = \frac{3}{3} \times 24 = 24$$

**Answer : 24 cookies**

**Q10 WORKING**

$$\text{Square} = 6\text{cm} \times 6\text{cm} = 36\text{cm}^2$$

$$\text{Quadrant} = \frac{1}{4} \times 6\text{cm} \times 6\text{cm} \times \pi = 9\pi\text{cm}^2$$

$$\text{Shaded} \times 2 = 36\text{cm}^2 - 9\pi\text{cm}^2 = (36 - 9\pi)\text{cm}^2$$

-----  
2

-----  
2

**Answer : (36 - 9π) cm<sup>2</sup>**

-----  
2



**Q11 WORKING**

$$1 \text{ round} \text{ --- } 300\text{m} \times 2 + 140\text{m} \times \frac{22}{7} = 1040\text{m}$$

$$3 \text{ rounds} \text{ --- } 1040\text{m} \times 3 = 3120\text{m} = 3.12\text{km}$$

$$80\text{min} = 1\text{h } 20\text{min} = 1\frac{1}{3}\text{h}$$

$$\text{Speed} \text{ --- } 3.12\text{km} \div 1\frac{1}{3}\text{h} = 2.34\text{km/h}$$

**Answer 2.34km/h**

**Q12 WORKING**

$$(a) \text{ height of CEF} \text{ --- } \frac{24 \times 2}{3} = 16$$

$$\text{CDF} \text{ --- } \frac{16 \times 4}{2} = 32$$

$$(b) \text{ ABF} \text{ --- } 24 \times 2 = 48$$

$$\frac{1}{2} \text{ of rectangle} \text{ --- } 48 + 32 = 80$$

$$\text{ABCD} \text{ --- } 80 \times 2 = 160$$

**Answer: (a) 32cm<sup>2</sup> (b) 160cm<sup>2</sup>**

**Q13 WORKING**

$$1 \text{ set} \text{ --- } (5 \times 2) - 1 = 9$$

$$\text{No. of sets} \text{ --- } 90 \div 9 = 10$$

$$\text{Correct} \text{ --- } 10 \times 5 = 50$$

$$\text{Total questions} \text{ --- } \frac{50}{5} \times 6 = 60$$

**Answer: 60**

**Q14 WORKING**

$$\frac{6}{20} + \frac{1}{20} = \frac{7}{20}$$

$$10p = 7p + 3u$$

$$3u = 3p$$

$$10u - 8u = 2u$$

$$2u = 35$$

$$20u = \frac{35}{2} \times 20 = 350$$

**Answer: 350**

**Q15 WORKING**

a)  $4p = \$0.80 \times 4 = \$3.20$

percentage discount  $= \frac{\$3.20 - \$2}{\$2} \times 100\% = 37.5\%$

-----  
\$3.20

b)  $11 \div 4 = 2R3$

Total  $= 2 \times \$2 + 3 \times \$0.80 = \$6.40$

**Answer: (a) 37.5%, (b) \$6.40**

**Q16 WORKING**

A : M : J

14 : 10 : -

7 : 8 : 10

---

112 : 80 : 100

$100U - 80u = 20u$

$20u = 150$

$1u = \frac{150}{20} = 7.5$

Total  $= 7.5 \times (112 + 80 + 100) = 2190$

**Answer: 2190**

### Q17 WORKING

$$\text{Headstart} - 300\text{cm}^3/\text{min} \times 5\text{min} = 1500\text{cm}^3$$

$$\text{Netflow} - 455\text{cm}^3/\text{min} - (300\text{cm}^3/\text{min} + 120\text{cm}^3/\text{min}) = 35\text{cm}^3/\text{min}$$

$$15\text{min} - 35\text{cm}^3/\text{min} \times 15\text{min} = 525\text{cm}^3$$

$$\text{Left} - 1500\text{cm}^3 - 525\text{cm}^3 = 975\text{cm}^3$$

$$\text{Height} - 975\text{cm}^3 \div 10\text{cm} \div 10\text{cm} = 9.75\text{cm}$$

**Answer: 9.75cm**

### Q18 WORKING

|            |   |                           |
|------------|---|---------------------------|
| Food No.   | X | Value = Total value       |
| CF (1u+14) | X | \$1.80 = (1.8u + \$25.20) |

|       |   |               |
|-------|---|---------------|
| PC 1U | X | \$2.50 = 2.5u |
|-------|---|---------------|

$$2.5u + \$2.10 = 1.8u + \$25.20$$

$$2.5u = 1.8u + \$23.0$$

$$2.5u - 1.8u = 0.7u$$

$$0.7u = \$23.10$$

$$1u = \$23.10 \div 0.7 = \$33$$

$$\text{a) popcorn no.} - (\$33 \times 2.5) \div \$2.50 = 33$$

$$\text{b) CF, earn} - \$33 \times 1.8 + \$25.20 = \$84.60$$

**Answer: a) 33, b) \$84.60**

**End of paper 2**