

Math Teacher:



**RAFFLES GIRLS' PRIMARY SCHOOL  
PRELIMINARY EXAMINATION  
MATHEMATICS (PAPER 1)  
PRIMARY 6**

Name: \_\_\_\_\_ (     )

Form Class: P6 \_\_\_\_\_

Date: 24 August 2016

Duration: 50 min

<b>Your Score (Out of 100 marks)</b>	
<b>Paper 1 (Out of 40 marks)</b>	
<b>Paper 2 (Out of 60 marks)</b>	
<b>Overall (Out of 100 marks)</b>	

INSTRUCTIONS TO CANDIDATES

1. Do not turn over this page until you are told to do so.
2. Follow all instructions carefully.
3. Answer **ALL** questions and show all working clearly.
4. **NO** calculator is allowed for this paper.

**SECTION A (20 marks)**

Questions 1 to 10 carry 1 mark each. Question 11 to 15 carry 2 marks each. For each question, four options are given. One of them is the correct answer. Make your choice (1, 2, 3 or 4). Shade your answer (1, 2, 3 or 4) on the OAS provided. All diagrams are not drawn to scale.

1. The value of the digit 5 in 957 321 is \_\_\_\_\_.

- (1) 500
- (2) 5 000
- (3) 50 000
- (4) 500 000

2.

$$\frac{12}{15} = \frac{8}{\boxed{?}}$$

What is the missing number in the box?

- (1) 9
- (2) 10
- (3) 11
- (4) 12

3. In the numeral 7.539, the digit 3 stands for \_\_\_\_\_.

- (1) 3 tens
- (2) 3 tenths
- (3) 3 hundredths
- (4) 3 thousandths

4. Express 40.32 litres in millilitres.

- (1) 432 ml
- (2) 4 032 ml
- (3) 4 320 ml
- (4) 40 320 ml

5. There are 4 800 books in a library. 20% of them are non-English books and the rest of them are English books. How many English books are there in the library?

- (1) 384
- (2) 960
- (3) 2880
- (4) 3840

6. A number becomes 70 000 when rounded off to the nearest thousand. Which one of the following could the number be?

- (1) 79 567
- (2) 70 893
- (3) 69 978
- (4) 69 499

7. Jim baked some cakes for sale. After selling  $\frac{3}{8}$  of the cakes in the morning and 20 cakes in the afternoon, he had 10 cakes left. How many cakes did he bake?

(1) 16

(2) 32

(3) 48

(4) 80

8. Express  $4\frac{1}{25}$  as a decimal.

(1) 4.04

(2) 4.1

(3) 4.25

(4) 4.4

9. A movie lasted 135 minutes. If the movie ended at 7 p.m., what time did it start?

(1) 4.45 p.m.

(2) 5.25 p.m.

(3) 8.35 p.m.

(4) 9.15 p.m.

10. The figure below consists of an equilateral triangle and a semi-circle. One of the sides of the triangle is 14 cm. What is the perimeter of the figure?

Take  $\pi = \frac{22}{7}$ .

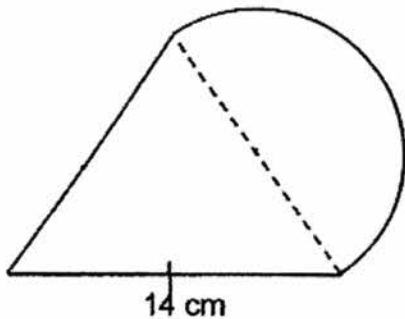

- (1) 50 cm  
(2) 64 cm  
(3) 105 cm  
(4) 366 cm
11. The length and breadth of a rectangle are both whole numbers. The length is three times as long as its breadth. Which of the following is not a possible perimeter of the rectangle?
- (1) 8 cm  
(2) 16 cm  
(3) 28 cm  
(4) 40 cm

12. Some Primary 4 pupils were asked to name the CCA they liked the most. Their choices were represented in the pie chart below. There was an equal number of pupils who liked swimming and softball. Find the total number of Primary 4 pupils who took part in the survey.

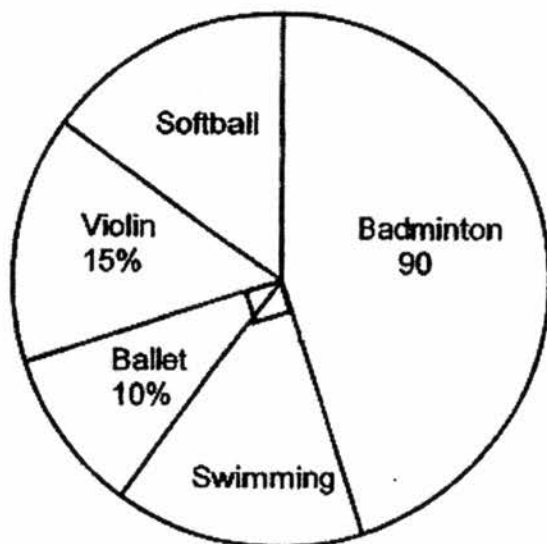

- (1) 110  
(2) 120  
(3) 180  
(4) 200
13. There were 130 members in a club in October. This was 30% more than the number of members in September. In November, 20 members left the club. What is the percentage increase in the number of members in November compared to September?
- (1) 10%  
(2) 20%  
(3) 22%  
(4) 50%

14. There are 3 unit shapes below. Which of the shape(s) below can be tessellated?

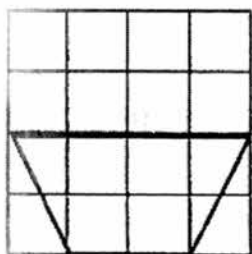

A

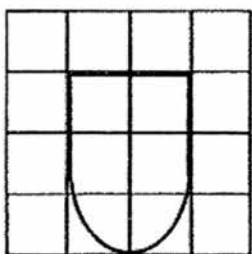

B

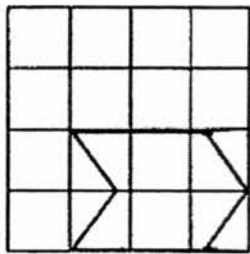

C

- (1) A only
- (2) B only
- (3) A and C only
- (4) B and C only
15. Some children are folding paper cranes during a craft lesson. In 9 minutes, 5 children can fold 10 paper cranes. How long does it take for 3 children to fold 72 paper cranes altogether?
- (1) 24 min
- (2) 36 min
- (3) 1 h 8 min
- (4) 1 h 48 min

**SECTION B (20 marks)**

Questions 16 to 25 carry 1 mark each. Write your answers in the spaces provided. For questions which require units, give your answers in the units stated. All diagrams are not drawn to scale. Answers in fractions or ratio must be expressed in the simplest form.

16. Arrange the following numbers from the smallest to the largest.

94 127, 94 172, 96 321, 96 231

Ans: \_\_\_\_\_

17. Find the value of  $\frac{3}{4} + 9 \times 2$ .

Give your answer as a fraction in the simplest form.

Ans: \_\_\_\_\_

18. Find the value of  $0.9 \times 70$ .

Ans: \_\_\_\_\_



19. What is the total amount of water in the two containers below?

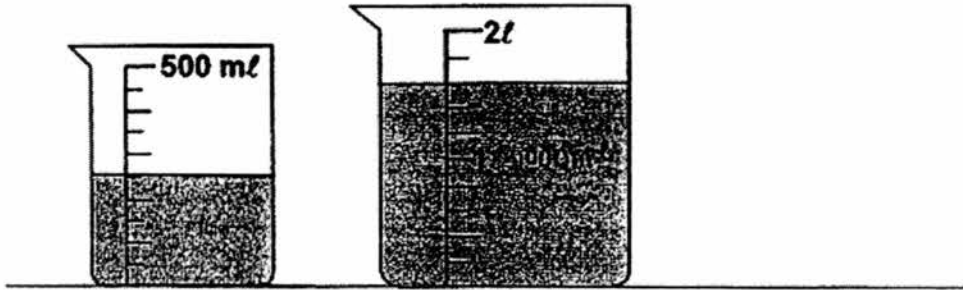

Ans: \_\_\_\_\_ ml

20. The base area of a cube is  $16 \text{ cm}^2$ . What is the volume of the cube?

Ans: \_\_\_\_\_  $\text{cm}^3$

21. The line graph below shows the distance Mr Leong jogged yesterday over a period of time. What was Mr Leong's average speed for the whole journey?

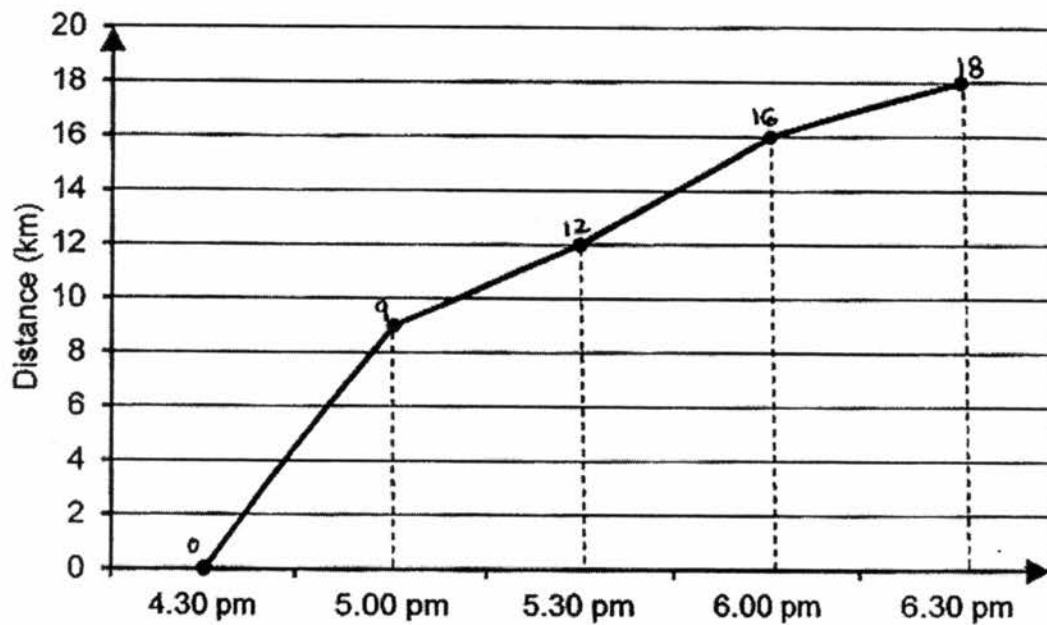

Ans: \_\_\_\_\_ km/h

22. Express 50 m as a percentage of 2 km.

Ans: \_\_\_\_\_ %

23. Express 8.55 as a mixed number in its simplest form.

Ans: \_\_\_\_\_

24. The diagram below shows a cube and its net. What is the letter, B, D, E or F on the missing face?

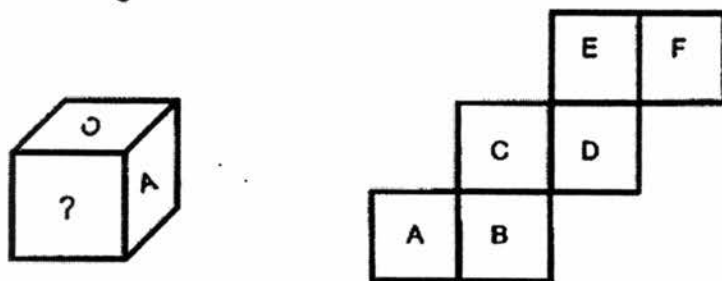

Ans: \_\_\_\_\_

25. Mr Singh spent  $\frac{2}{7}$  of his salary on transport. Mr Mani spent  $\frac{3}{8}$  of his salary on transport. They spent the same amount of money on transport. What was the ratio of Mr Singh's salary to Mr Mani's salary?  
Express your answer in its simplest form.

Ans: \_\_\_\_\_

Questions 26 to 30 carry 2 marks each. Show your working clearly in the space provided for each question and write your answers in the space provided. For questions which require units, give your answers in the units stated. All diagrams are not drawn to scale. Answers in fractions or ratio must be expressed in the simplest form.

26. Samy earns \$5 for every chair he sells. For every 10 chairs that he sells, he will get an additional \$50. How many chairs must he sell to earn \$330?

Ans: \_\_\_\_\_

27. A wire is bent to make the figure below. It consists of 3 semicircles. Find the length of the wire.

Take  $\pi = 3.14$ .

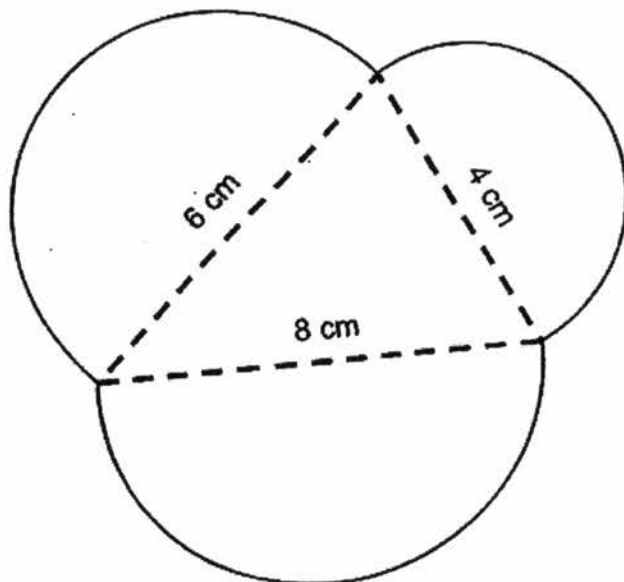

Ans: \_\_\_\_\_ cm

28.



Joshua wants to spend the least amount of money to buy 25 muffins for his party. Each muffin is sold at  $\$m$ . He has  $\$100$ . How much money will he have left after paying for the muffins? Express your answer in terms of  $m$ .

Ans: \$ \_\_\_\_\_

29. In the figure below, PQRS is a rectangle and  $TS = SA$ . TABQ, TSR and DBC are straight lines. Given that  $\angle ADB$  is  $65^\circ$ , find  $\angle QBC$ .

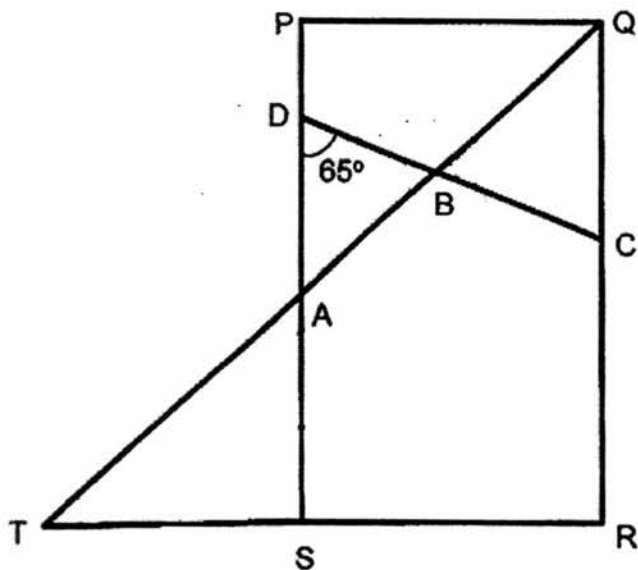

Ans: \_\_\_\_\_<sup>o</sup>

30. MN forms one side of a rectangle LMNO. LM is twice the length of MN. Complete the drawing of the rectangle LMNO in the square grid below. [2]

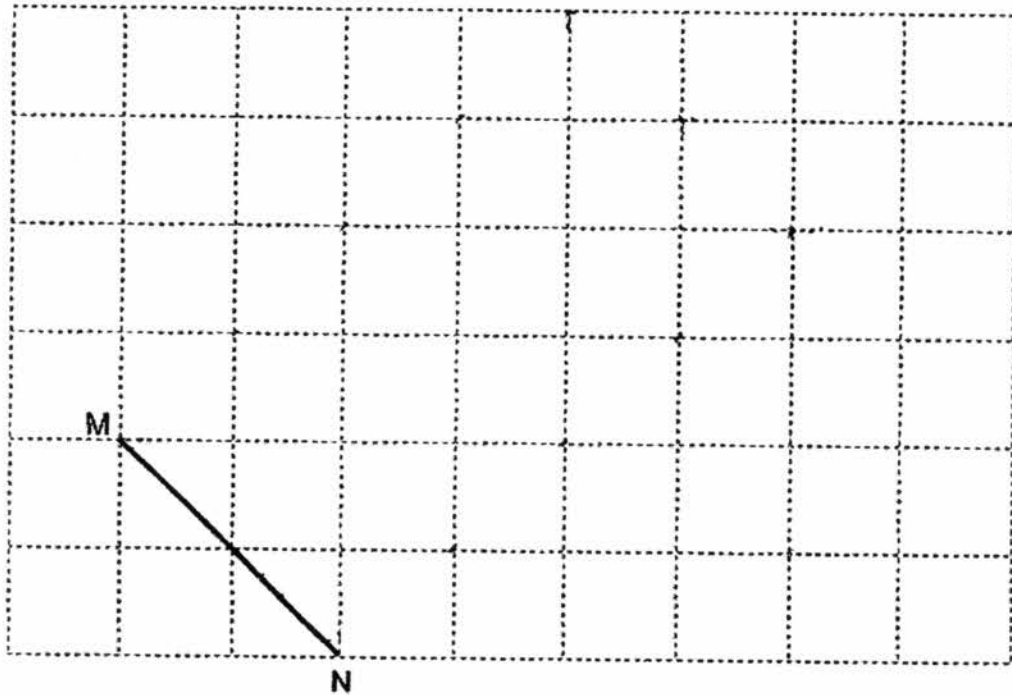

**-End of Paper-**

**Please check your work carefully ☺**

Setters: E Tang  
Wirda S  
Tan KK



**RAFFLES GIRLS' PRIMARY SCHOOL  
PRELIMINARY EXAMINATION  
MATHEMATICS (PAPER 2)  
PRIMARY 6**

Math Teacher:

Name: \_\_\_\_\_ ( )

Form class: P6 \_\_\_\_\_

Date: 24 August 2016

Duration: 1 h 40 min

**INSTRUCTIONS TO CANDIDATES**

1. Do not turn over this page until you are told to do so.
2. Follow all instructions carefully.
3. Answer **ALL** questions and show all working clearly.
4. The use of calculator is allowed for this paper.

Questions 1 to 5 carry 2 marks each. Show your working clearly and write your answers in the spaces provided. For questions which require units, give your answers in the units stated. All the diagrams are not drawn to scale. (10 marks)

---

1. There were 17 bottles of candies. Each bottle contained  $b$  candies. 2 bottles of candies were sold. The remaining candies were shared equally among 3 girls. How many candies did each girl receive?  
Express your answer in terms of  $b$ .

Ans: \_\_\_\_\_ [2]

2. The original price of a gown was \$780. It was sold at a discount of 15%. As a member of the store, Siti was given a further discount of \$50. How much did Siti pay for the gown?

Ans: \$ \_\_\_\_\_ [2]

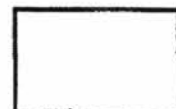



3. In the diagram below, PQRS is a square. J, K, L and M are midpoints of PQ, QR, RS and SP respectively. Find the sum of  $\angle w$ ,  $\angle x$ ,  $\angle y$  and  $\angle z$ .

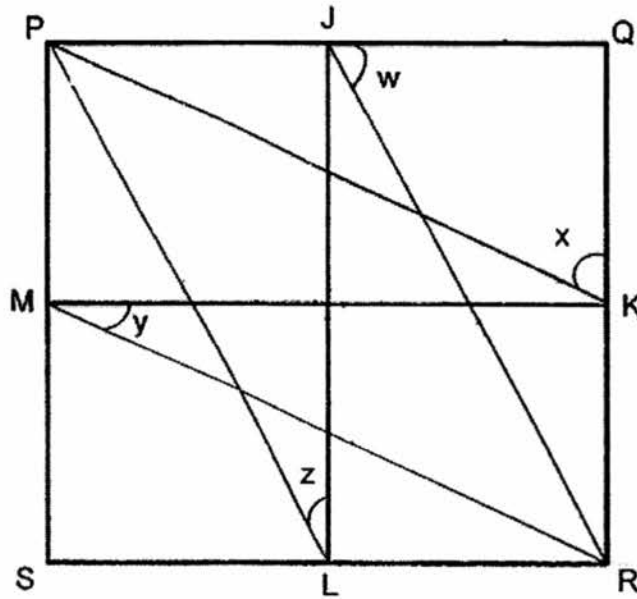

Ans: \_\_\_\_\_<sup>°</sup> [2]

4. Fill in the missing fraction below.

$$\frac{4}{9}, \frac{11}{18}, \boxed{?}, \frac{17}{18}, 1\frac{1}{9}$$

Ans: \_\_\_\_\_ [2]

5. Fill in the missing operations ( + , - , × or ÷ ) in the boxes.

$$90 \square 3 + 2 \times (43 \square 15) = 146 \quad [2]$$

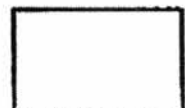
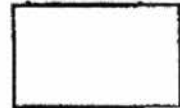

For questions 6 to 18, show your working clearly and write your answers in the spaces provided. The number of marks available is shown in brackets [ ] at the end of each question or part-question. (50 marks)

---

6. Empty box P has a mass of 1.8 kg. Box P with 8 packets of flour and 6 packets of salt has a mass of 21.4 kg. Each packet of flour has a mass of 2 kg 60 g. What is the mass of each packet of salt? Give your answer in kilograms.

Ans: \_\_\_\_\_ [3]

7. Miss Pang bought  $n$  pens at \$2 each to give to her pupils in 3 classes. Each class has the same number of pupils.
- (a) How much did she spend on the pens for each class? Express the answer in terms of  $n$ .
- (b) Given that  $n = 78$ , how much did she spend on the pens for each class?

Ans: (a) \_\_\_\_\_ [1]

(b) \_\_\_\_\_ [2]



8. Mrs Eng packed some beads equally into 10 bags. 4 bags were found to be torn, so she transferred the beads from the 4 torn bags equally into each of the remaining bags. The remaining bags each had 20 more beads as a result. How many beads were there altogether?

Ans: \_\_\_\_\_ [3]

9. Mary had 650 red pens and 100 blue pens. After selling  $\frac{2}{5}$  of the red pens and some blue pens, she had 450 red and blue pens left. How many blue pens did he sell?

Ans: \_\_\_\_\_ [3]

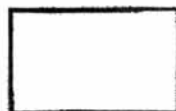

10. A group of Primary 1 pupils were asked to vote for the colour they liked the most. The results were represented in the pie chart below.

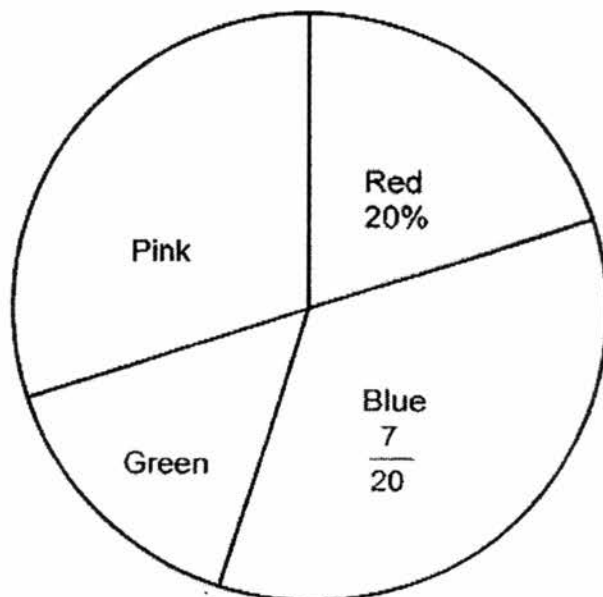

Half of the number of pupils voted for red and pink colour.

- (a) 12 more pupils voted for pink colour than green colour. How many pupils voted for red colour?
- (b) 10 additional pupils were asked to vote. They voted for pink colour. What fraction of all the pupils voted for pink colour?

Ans: (a) \_\_\_\_\_ [2]

(b) \_\_\_\_\_ [2]

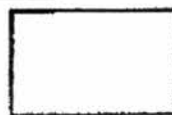

11. The table below shows the prices of prawns in a market.

Weight of prawns	Price
First 2 kg	\$16 per kg
Every additional 1 kg	\$14 per kg

- (a) James bought 6 kg of prawns. How much did he pay?
- (b) Michelle paid \$130 for some prawns. How many kilograms of prawns did she buy?

Ans: a) \_\_\_\_\_ [2]

b) \_\_\_\_\_ [2]

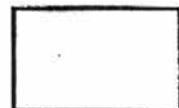

12. The cost of a plate was 5 times the cost of a spoon. At first, Siti used  $\frac{5}{9}$  of her money to buy 4 plates and 30 spoons. Then, she decided to buy some more plates with  $\frac{3}{8}$  of her remaining money. How many more plates did Siti buy?

Ans: \_\_\_\_\_ [4]

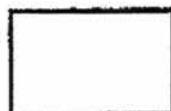

13. The figure below shows the cross-section of a swimming pool with a sloping depth. The swimming pool is made up of 2 sections, A and B. The volume of Section B is 40% of the volume of Section A.

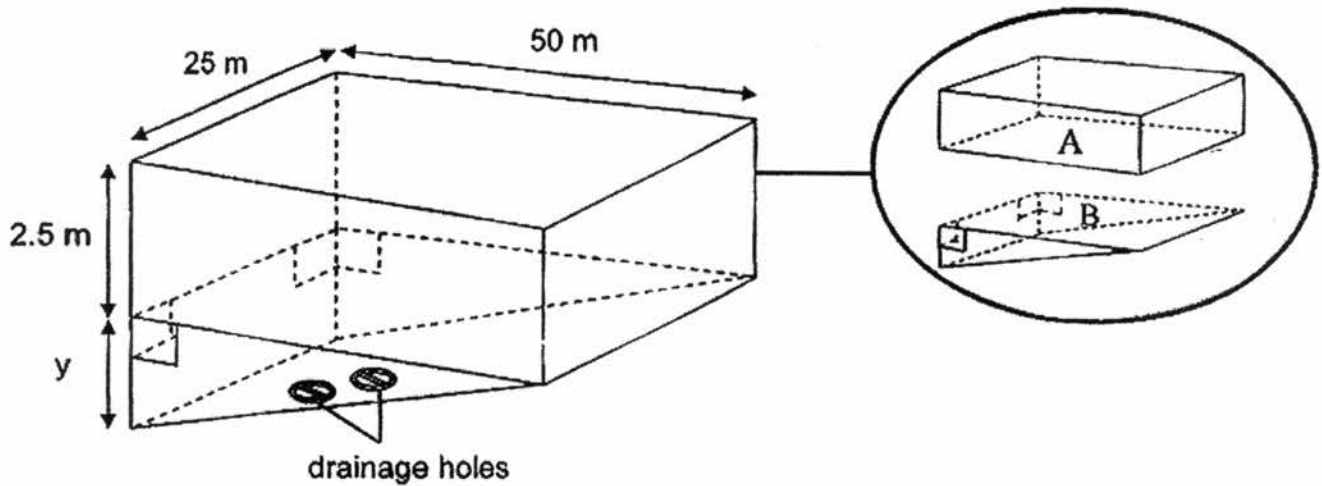

- (a) Given that the dimensions of Section A is 50 m by 25 m by 2.5 m, find the height  $y$ .
- (b) There are two drainage holes at the bottom of the swimming pool. The two holes allow water to drain out at an equal rate and it takes 2.5 hours to drain out all the water in the swimming pool.  
Find the amount of water drained in 1 hour by each hole.  
Give your answer in  $\text{m}^3$ .

Ans: (a) \_\_\_\_\_ [2]

(b) \_\_\_\_\_ [2]

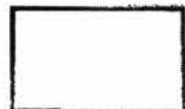



14. Calvin and David each saved a fixed amount of money daily. David saved \$4 daily and he started saving before Calvin. When David saved for 15 days, Calvin had saved \$40. When David saved for 20 days, each of them had saved an equal amount of money in total.

How much did Calvin save a day?

Ans : \_\_\_\_\_ [3]

15. Amy drove Beatrice from their home to the market. From the market, Beatrice walked 2 km to the shopping centre at a speed of 4 km/h. At the same time, Amy drove home from the market to pick her son up. She then drove along the same route from home to meet Beatrice at the shopping centre. Amy drove at an average speed of 80 km/h throughout the journey. All of them reached the shopping centre at the same time. Find the distance between their home and the shopping centre.

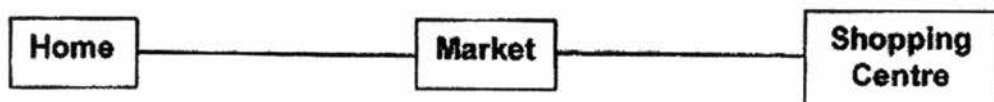

Ans: \_\_\_\_\_ [4]



16. There were some girls in the hall at first.  $\frac{5}{8}$  of the girls left the hall for their recess. Later,  $\frac{1}{6}$  of the remaining girls left the hall too.
- (a) What fraction of the girls remained in the hall then?
- (b) After recess, 225 girls entered the hall. The ratio of the number of girls in the end to the number of girls at first was 7 : 8.  
How many girls were there in the hall at first?

Ans: (a) \_\_\_\_\_ [2]

(b) \_\_\_\_\_ [3]

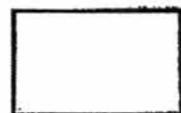

17. There were 286 more balloons than soft toys at a carnival at first. There were 16% more balloons sold than soft toys<sup>sold</sup>. The number of soft toys left was 162 more than the number of balloons left.

(a) How many more balloons than soft toys were sold?

(b) How many balloons were sold?

Ans: (a) \_\_\_\_\_ [2]

(b) \_\_\_\_\_ [3]

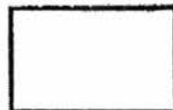

18. The figure below consists of 5 squares of side 6 cm, 2 quadrants and 2 semi-circles.

- (a) Find the area of the shaded parts.
- (b) The dotted line AB divides the shaded area into 2 equal parts.  
Find the area of semi-circle P.

Take  $\pi = 3.14$ .

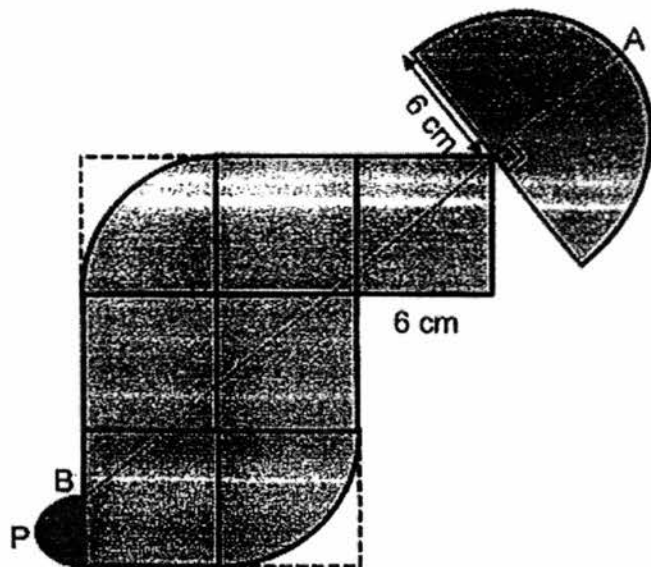

-End of Paper-

Please check your work carefully ☺

Setters: E Tang, Wirda S, Tan KK



**EXAM PAPER 2016**

**SCHOOL : RAFFLES GIRLS'**

**SUBJECT : MATHEMATICS**

**TERM : PRELIM (SA2)**

Q1	Q2	Q3	Q4	Q5	Q6	Q7	Q8	Q9	Q10
3	2	3	4	4	3	3	1	1	1
Q11	Q12	Q13	Q14	Q15					
3	4	1	3	4					

16)  $94127, 94172, 96231, 96321$

17)  $1/6 \div 2 = 1/12$

$1/12 \times 9 = 9/12 = 3/4$

18)  $0.9 \times 70 = 9 \times 7 = 63$

19)  $1600 + 250 = 1850\text{ml}$

20)  $\sqrt[3]{63} = 4$

$4 \times 4 = 16\text{cm}^3$

21)  $9\text{km/h}$

22)  $2.5\%$

23)  $8_{11/20} = 8_{11/20}$

24) E

25)  $21 : 16$

26)  $330 \div 100 = 3\text{R } 30$

$30 \div 5 = 6$

$3 \times 10 + 6 = 36$

27)  $1/2 \times 3.14 \times 6 = 9.42$

$1/2 \times 3.14 \times 4 = 6.28$

$1/2 \times 3/14 \times 8 = 12.56$

$12.56 + 6.28 + 9.42 = 28.26\text{cm}$

$$28) 25 \div 3 = 8 \text{ R}1$$

$$2 \times M = 2M$$

$$8 \times 2 = 16M$$

$$1M = M$$

$$100 - (16M + M) = \$ (100 - 17M)$$

$$29) 180^\circ - 90^\circ / 2 = 45^\circ$$

$$180^\circ - 65^\circ = 115^\circ$$

$$= 180^\circ - 110^\circ = 70^\circ$$

### Paper 2

$$1) 17 - 2 = 15$$

$$15 \times b/3 = 15b/3 = 5b \text{ candies}$$

$$2) 100\% - 15\% = 85\%$$

$$780 \times 85\% = 663$$

$$663 - 50 = \$613$$

$$3) \angle w = \angle x$$

$$\angle y = \angle z$$

$$\angle z + \angle x = 90^\circ$$

$$\angle z + \angle x = \angle y + \angle w$$

$$= 90^\circ \times 2 = 180^\circ$$

$$4) 14/18 = 7/9$$

$$5) \div +$$

$$6) 21.4 - 16.48 - 1.8 = 3.12$$

$$3.12 \div 6 = 0.52 \text{kg}$$

$$7) a) n \times 2/3 = \$(2n/3)$$

$$b) (2 \times 78) \div 3 = \$52$$

30)

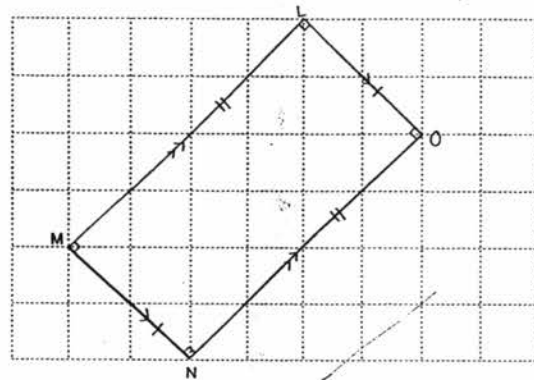

$$8) 10 - 4 = 6$$

$$20 \times 6 = 120$$

$$120 \div 4 = 30$$

$$30 \times 10 = 300$$

$$9) 650 \times \frac{3}{5} = 390$$

$$450 - 390 = 60$$

$$100 - 60 = 40$$

$$10) 50\% - 20\% = 30\%$$

$$50\% - 35\% = 15\%$$

$$30\% - 15\% = 15\%$$

$$15\% \rightarrow 12$$

$$5\% \rightarrow 12 \div 3 = 4$$

$$20\% \rightarrow 4 \times 4 = 16$$

$$100\% \rightarrow 5 \times 16 = 80$$

$$30\% \rightarrow 6 \times 4 = 24$$

$$24 + 10/80 + 10 = 17/45$$

$$a) 16$$

$$b) 17/45$$

$$11) a) 2 \times 16 = 32$$

$$6 - 2 = 4$$

$$4 \times 14 = 56$$

$$56 + 32 = \$88$$

$$b) 2 \times 16 = 32$$

$$130 - 32 = 98$$

$$98 \div 14 = 7$$

$$7 + 2 = 9\text{kg}$$



$$12) 5/9 \rightarrow 4p + 30s = 4 \times 5u + 30 \times 1u = 20u + 30u = 50u$$

$$1/9 \rightarrow 50u \div 5 = 10u$$

$$9 - 5 = 4$$

$$4/9 \rightarrow 4 \times 10u = 40u$$

$$3/8 \times 40u = 15u$$

$$15u \div 5u = 3$$

$$13)a) 50 \times 25 \times 2.5 = 3125$$

$$3125 \div 5 \times 2 = 1250$$

$$1250 \div 25 = 50$$

$$50 \times 2 = 100$$

$$100 \div 50 = 2m$$

$$b) 3125 + 1250 = 4375$$

$$4375 \div 2.5 = 1750$$

$$1750 \div 2 = 875m_3$$

$$14) 4 \times 15 = 60$$

$$60 - 40 = 20$$

$$20 - 15 = 5$$

$$20 \div 5 = 4$$

$$4 + 4 = \$8$$

$$15) 2 \div 4 = \frac{1}{2}$$

Amy took  $\frac{1}{2}$  h to drive from M to H then to SC

$$2 \div 80 = 1/40$$

$$\frac{1}{2} - 1/40 = 19/40$$

$$19/40 \div 2 = 19/80$$

$$19/80 \times 80 = 19$$

$$19 + 2 = 21km$$

16)a)  $5/6 \times 3/8 = 5/16$

b)  $5/16 G + 225 = 7p$

$16/16 G = 8p$

$2/16 G = 1p$

$14/16 G = 7p$

$14/16 G - 5/16 G = 9/16 G$

$225 \div 9 \times 16 = 400$

17)  $(100u + 286 + 162) - 116p = 100u - 100p$

$(100u + 448) - 116p = 100u - 100p$

$(100u + 448) - 16p = 100u$

$100u + 448 = 100u + 16p$

$16p = 448$

$1p = 448 \div 16 = 28$

$116p = 116 \times 28 = 3248$

a) 448

b) 3248

18)  $\frac{1}{2} \times 3.14 \times 6 \times 6 = 56.52$

$5 \times 6^2 = 180$

$\frac{1}{2} \times 3.14 \times 6 \times 6 = 56.52$

$56.52 \times 2 + 180 = 293.04$

$293.04 \div 2 = 146.52$

$146.52 - 56.52 \div 2 = 118.26$

$6^2 - 56.5 \div 2 = 7.74$

$118.26 + 7.74 = 126$

$126 \times 2 = 252$

$252 \div (3 \times 6) = 14$

$6 \times 3 = 18$

$18 - 14 = 4$

$4 \div 2 = 2$

$\frac{1}{2} \times 3.14 \times 2 \times 2 = 6.28$

a) 293.04 cm<sup>2</sup>

b) 6.28 cm<sup>2</sup>