

Name : _____ ()

Date: _____

Class : Primary 6 SY/C/G/SE/P

SINGAPORE CHINESE GIRLS' SCHOOL

PRELIMINARY EXAMINATION 2009

PRIMARY 6

MATHEMATICS

PAPER 1

Booklet A

Booklet A	Mark	Max Mark	Parent's Signature
		20	

15 Questions

20 Marks

Total Time For Booklets A and B : 50 min

DO NOT OPEN THIS BOOKLET UNTIL YOU ARE TOLD TO DO SO.

FOLLOW ALL INSTRUCTIONS CAREFULLY.

ANSWER ALL QUESTIONS.

Questions 1 to 10 carry 1 mark each. Questions 11 to 15 carry 2 marks each. For each question, four options are given. One of them is the correct answer. Make your choice (1, 2, 3 or 4). Shade the correct oval (1, 2, 3 or 4) on the Optical Answer Sheet.

(20 marks)

1. Which of the following numbers below has the same digit in the hundreds and tenths place?
 - (1) 432.04
 - (2) 586.84
 - (3) 754.78
 - (4) 873.22

2. Round off 76 495 to the nearest thousands.
 - (1) 76 000
 - (2) 76 500
 - (3) 77 000
 - (4) 80 000

3. What is value of $60 - (18 + 12) \div (5 \times 6)$?
 - (1) 1
 - (2) 24
 - (3) 36
 - (4) 59

4. Divide $\frac{6}{15}$ by $\frac{2}{3}$.
 - (1) $\frac{3}{5}$
 - (2) $\frac{4}{5}$
 - (3) $\frac{4}{15}$
 - (4) $\frac{12}{45}$

5. Express 3.2 h in minutes.

- (1) 182 min
- (2) 192 min
- (3) 200 min
- (4) 312 min

6. Each figure below is made up of 16 squares. 8 squares in each figure are shaded. Which of the following is a symmetric figure?

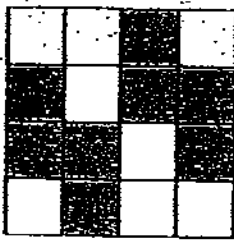

(1)

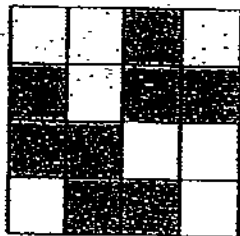

(2)

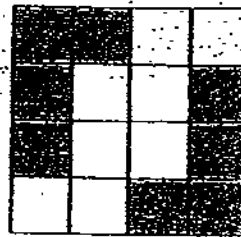

(3)

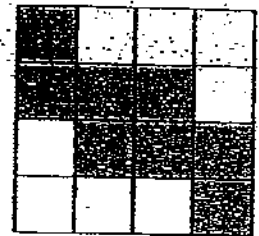

(4)

7. A machine can print 90 copies in 5 minutes.

At this rate, how many copies can it print in $\frac{1}{2}$ h ?

- (1) 150
- (2) 180
- (3) 540
- (4) 900

8. Express $12\frac{1}{2}\%$ as a decimal.

- (1) 1.25
- (2) 12.5
- (3) 1250
- (4) 0.125

9. Simplify $10g + 7h + g - 4h - 3g$.

- (1) $8g + 3h$
- (2) $8g + 11h$
- (3) $11g + 3h$
- (4) $14g + 11h$

10. The usual price of a watch is \$120 but Mrs Lee bought it at \$90 at a sale.
What is the percentage of discount?

- (1) 10 %
- (2) 25 %
- (3) 30 %
- (4) 75 %

11. The lines in the figure shown below meet at right angles.
Find the perimeter of the figure.

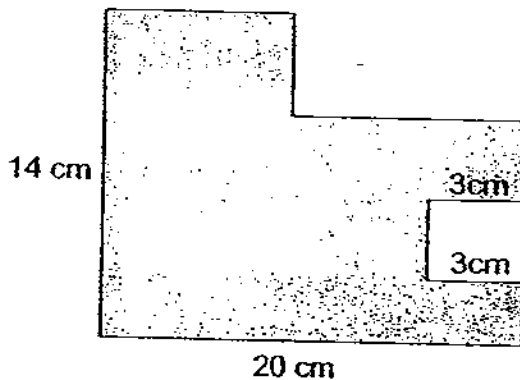

- (1) 40cm
- (2) 68 cm
- (3) 74 cm
- (4) 280 cm

12. Jane had some apples and oranges. After that she had given away $\frac{1}{4}$ of the apples and $\frac{2}{3}$ of her oranges, there were equal number of apples and oranges left. What is the ratio of the number of apples to the number of oranges at first?

- (1) 3 : 8
- (2) 8 : 3
- (3) 4 : 9
- (4) 9 : 4

13. The pie chart below shows the number of stalks of each type of flowers sold by a florist. There were 30 more stalks of carnations than roses. How many stalks of tulips did the florist have?

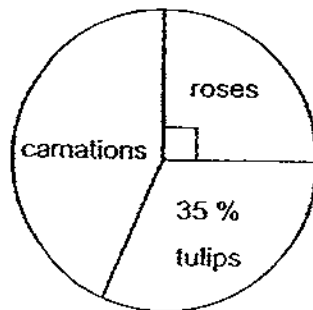

- (1) 30
- (2) 35
- (3) 42
- (4) 70

14. The average mass of some parcels in a box was 20 kg at first. When another parcel which weighs 10 kg is added into the box, the average mass became 18 kg. How many parcels are in the box now?

- (1) 6
- (2) 5
- (3) 3
- (4) 4

15. Alan completed a race in 1h 40 min. In the race, he ran at an average speed of 30 m/min from Point A to Point B and then ran back from Point B to Point A at an average speed of 20 m/min. How long did he take to run back to Point A from Point B?

- (1) 40 min
- (2) 50 min
- (3) 60 min
- (4) 100 min

Name : _____ ()

Date: _____

Class : Primary 6 SYICIGISEYP

SINGAPORE CHINESE GIRLS' SCHOOL

PRELIMINARY EXAMINATION 2009

PRIMARY 6

MATHEMATICS

PAPER 1

Booklet B

	Mark	Max Mark
Booklet B		20

Parent's Signature

15 Questions

20 Marks

Total Time For Booklets A and B : 50 min

DO NOT OPEN THIS BOOKLET UNTIL YOU ARE TOLD TO DO SO.

FOLLOW ALL INSTRUCTIONS CAREFULLY.

ANSWER ALL QUESTIONS.

Questions 16 to 25 carry 1 mark each. Write your answers in the spaces provided. For questions which require units, give your answers in the units stated. (10 marks)

16. Arrange the following fractions in ascending order.

$$\frac{5}{6}, \frac{3}{8}, \frac{7}{12}, \frac{3}{10}$$

Ans: _____

17. Find the value of $2\frac{1}{3} + 1\frac{1}{4} - \frac{5}{6}$. (Give your answer in its simplest form.)

Ans: _____

18. What fraction of the figure is shaded?

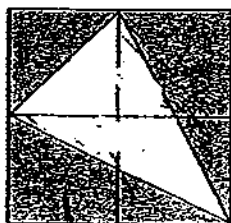

Ans: _____

19. In a class of 40 pupils, 18 of them are girls. What is the ratio of the number of boys to the number of girls? (Give your answer in its simplest form.)

Ans: _____

20. Find the value of $\frac{8f+7}{3}$ when $f = 4$.

Ans: _____

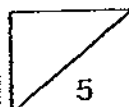

Do not write
in this column

Do not write
in this column

21. Beth had $\frac{3}{7}$ of what Jane had. After Jane had given Beth \$30, both had the same amount of money. How much had Beth at first?

Ans: \$ _____

22. Susan goes to the market once every 3 days. Mrs Lee also goes to the market once every 5 days. If they first met in the market on the 12th September, on which day would they next meet?

Ans: _____

23. The figure below is made up of a quadrant and a semi-circle. Find the perimeter of the shaded region. (Take $\pi = \frac{22}{7}$)

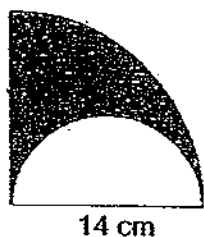

Ans: _____ cm

24. Express 75g as a fraction of $1\frac{1}{2}$ kg. (Give your answer in its simplest form.)

Ans: _____

25. In the figure, not drawn to scale, ABCD is a square. EDC is a straight line. Find $\angle p$.

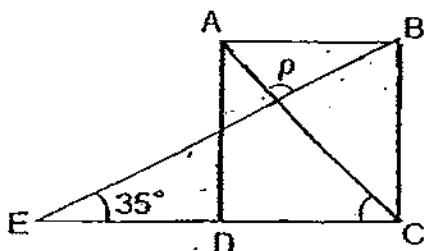

Ans: _____

Questions 26 to 30 carry 2 marks each. Show your working clearly in the space for each question and write your answers in the spaces provided. For questions which require units, give your answers in the units stated. (10 marks)

26. The area of a rectangle is 294 cm^2 .

Given that its breadth is $\frac{2}{3}$ its length, find its breadth.

Ans: _____ cm

27. A rectangular tank contains 32 litres of water and the water level is 20 cm. 8 litres of water is poured out of the tank. What is the new water level?

Ans: _____ cm

28. The table shows the parking charges at a car park.

Parking Charges	
From 8 a.m. to 5 p.m.	\$2.50 for the first hour
Every additional half hour or part thereof	\$1.50

Gary parked his car from 2.45 p.m. to 5 p.m.

How much did he pay for the parking charges?

Ans: \$ _____

Do not write
in this column

29. Alice is n years old now. 4 years ago, Alice was twice as old as Betty. How old was Betty 4 years ago?

Do not write
in this column

Ans: _____ yrs old

30. A total of 150 boxes of hair clips were examined. The graph below shows the number of faulty hair clips in each box.

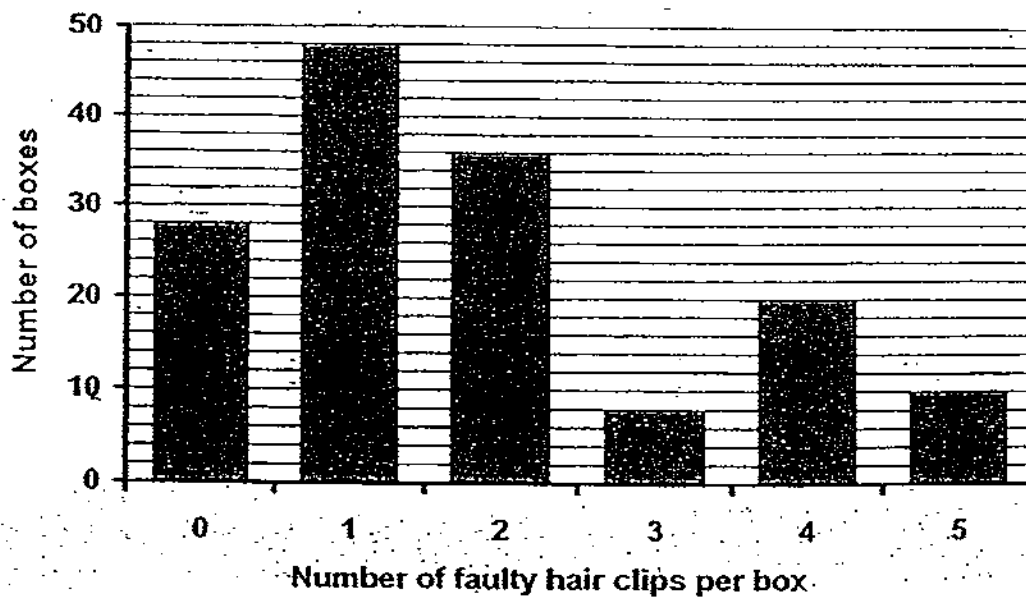

What percentage of the total number of boxes contain at least 4 faulty hair clips per box?

Ans: _____

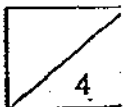

Name : _____ ()

Date: _____

Class : Primary 6 SYICIG/SEIP

SINGAPORE CHINESE GIRLS' SCHOOL

PRELIMINARY EXAMINATION 2009

PRIMARY 6

MATHEMATICS

PAPER 2

	Mark	Max Mark
Paper 2		60

Parent's Signature

18 Questions

60 Marks

Total Time For Paper 2 : 1 h 40 min

DO NOT OPEN THIS BOOKLET UNTIL YOU ARE TOLD TO DO SO.

FOLLOW ALL INSTRUCTIONS CAREFULLY.

ANSWER ALL QUESTIONS.

Questions 1 to 5 carry 2 marks each. Show your working clearly in the space below each question and write your answers in the space provided. For questions which require units, give your answers in the units stated. (10 marks)

Do not write in this colour

1. Miss Goh bought 5 pens and a file for \$13.60. Each pen cost \$1.60 less than the file. Find the cost of the each pen.

Ans: \$ _____

2. A tin of paint weighed 6 kg when it was $\frac{1}{2}$ full. When it was $\frac{1}{3}$ full, it weighed 4.2 kg. What was the mass of the tin when it was empty?

Ans: _____ g

3. Identify the unit shape in the given tessellation. Using the same unit shape, draw 8 unit shapes on the blank grid below to show a different tessellation.

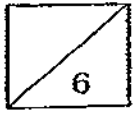
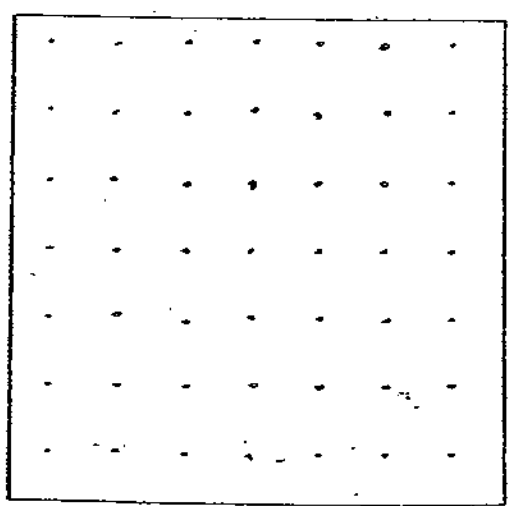
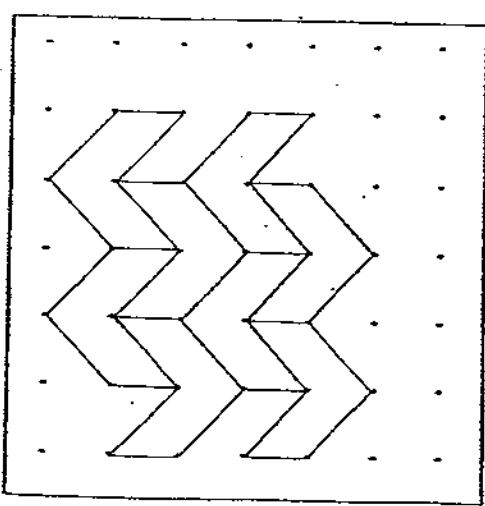

4. In the figure, not drawn to scale, ABCD is a parallelogram and CDE is a triangle. EG is a straight line and HG is parallel to DC. $\angle DGH = 110^\circ$ and $\angle ADG = 130^\circ$. Find $\angle ABC$.

Do not write
in this column

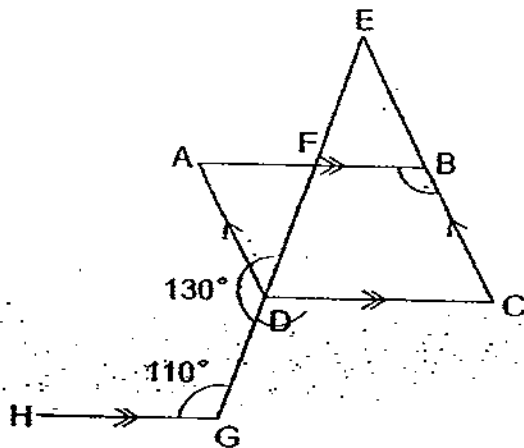

Ans: _____

5. The figures below show a cube and the net of the same cube.

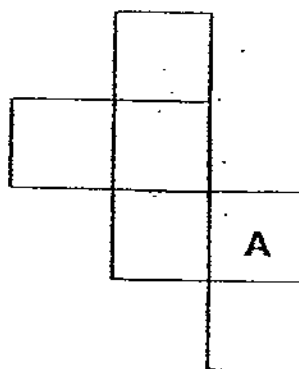
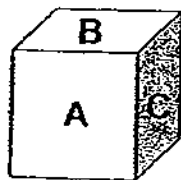

Write the letter B and C in the net given above.

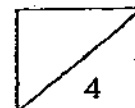

For questions 6 to 18, show your working clearly in the space below each question and write your answers in the spaces provided. The number of marks awarded is shown in brackets [] at the end of each question or part-question. (50 marks)

6. The ratio of the amount of money Colin has to the amount of money Daniel has is 4 : 7. After each of them spends \$28, their ratio becomes 3 : 7.
Find the amount of money Colin has now.

Do not write
in this column

Ans: _____ [3]

7. Tank A, measuring 60 cm by 30 cm by 20 cm, is completely filled with water. Tank B that has a base of 48 cm by 25 cm is filled with water to a depth 10 cm. Water is poured from tank A into tank B until the heights of the water level in both tanks are the same. Find the height of the water level.

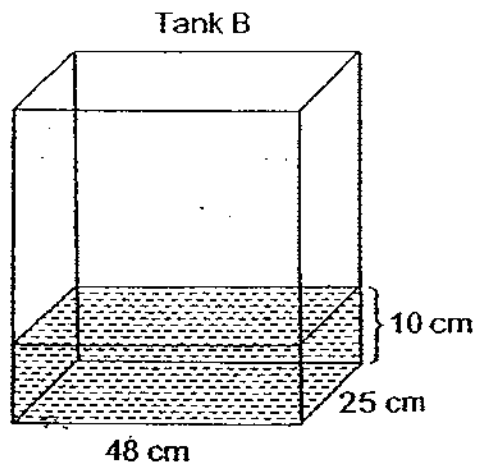
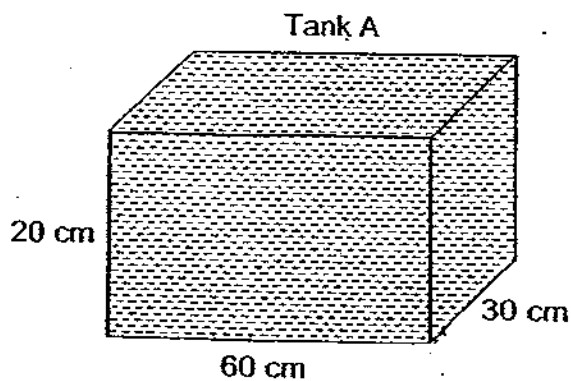

Ans: _____ [3]

8. Draw a parallelogram PQRS such that $PQ = 5.6$ cm, $PS = 4.5$ cm and $\angle SPQ = 72^\circ$. [2]

Measure and write down the length of QS. [1]

Do not write
in this column

Ans: _____ [3]

9. Mrs Lim had 50 stamps. 60% of them were local stamps and the rest were foreign stamps. After she used some local stamps, the percentage of stamps that were local stamps decreased to 20%. How many local stamps had she left?

Ans: _____ [3]

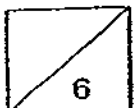

10. The shapes in the table are made up of circles, triangles and straight lines. Study the pattern carefully and answer the questions that follow.

Do not write in this column

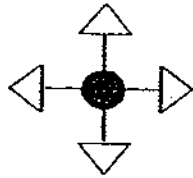

Pattern 1

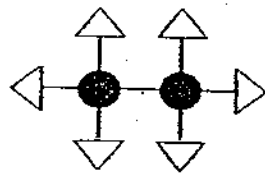

Pattern 2

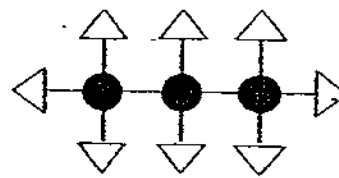

Pattern 3

Pattern number	1	2	3	...	25	100
Number of triangles	4	6	8	...		202
Number of straight lines	4	7	10	...	76	

- a) How many triangles are needed to form the shape in Pattern 25?

- b) Which pattern has a shape that made up of 109 straight lines?

Ans: (a) _____ [1]

(b) _____ [2]

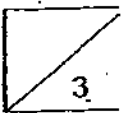

11. The figure below is made up of two identical squares, ABCD and EFGH. The area of each square is 100 cm^2 . Point E is the centre of square ABCD.
- (a) What is the area of the shaded region?
- (b) What fraction of the figure is shaded?

Do not write
in this column

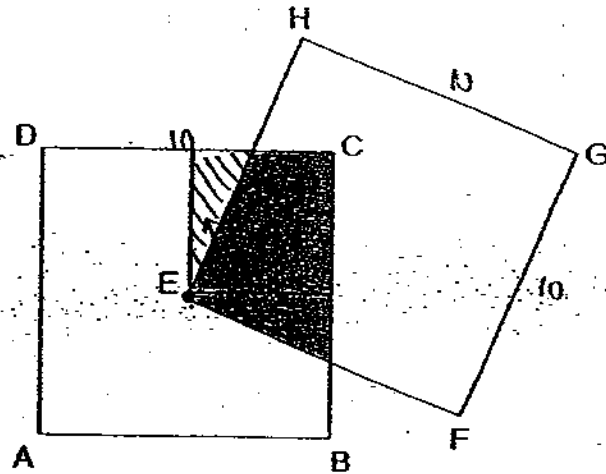

Ans: (a) _____ [2]

(b) _____ [2]

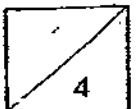

12.

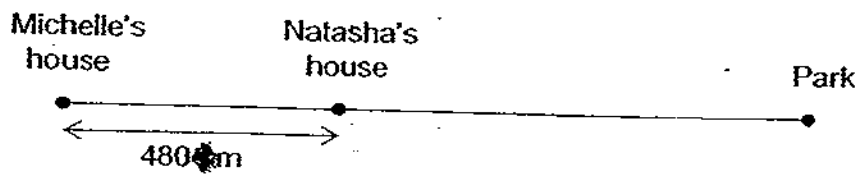

Michelle's house and Natasha's house are 480 m apart. Both girls walked from their house to the park at the same time. Michelle caught up with Natasha after 40 minutes. Given that Natasha's speed is 68 m/min, find the time taken for Michelle to walk from her house to Natasha's house.

Do not write
in this colour

Ans: _____ [4]

4

13. The figure below shows an open rectangular box 2 cm thick and its internal dimensions are 50 cm long, 42 cm wide and 18 cm deep. Find the volume of wood needed in making the box.

Do not write in this column

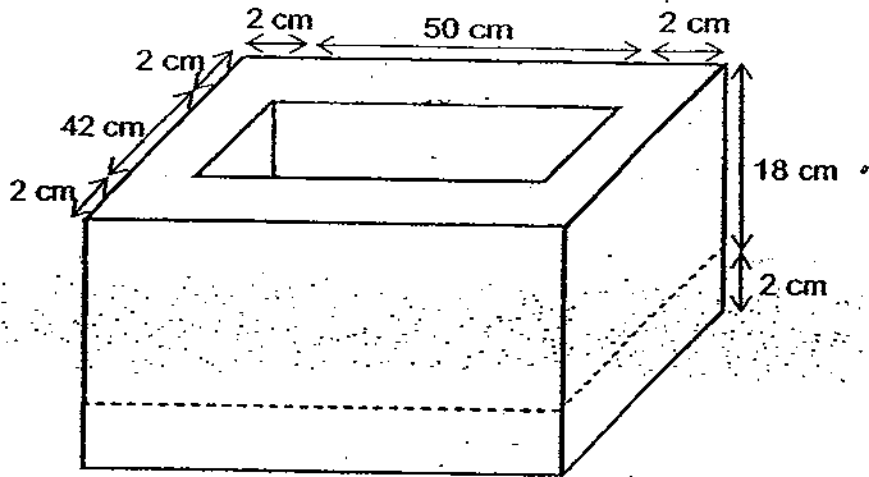

Ans: _____ [4]

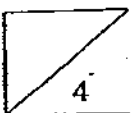

14. Mrs Lim bought some forks and spoons in the ratio of 4:3. Each spoon cost 50 cents more than each fork. If she spent \$156 altogether and the amount she spent on the forks was \$12 more than the amount she spent on the spoons, how many forks and spoons did she buy?

Do not write
in this column

Ans: _____ [4]

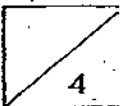

15. Mr. Tan had 130 durians and mangosteens. After he sold $\frac{2}{3}$ of the durians and $\frac{2}{5}$ of the mangosteens, he had 36 more mangosteens than durians left.
How many fruits had he left in all?

Do not write
in this column

Ans: _____ [4]

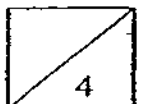

16. The figure below is made up of a circle, a triangle and two identical semi-circles. The diameter of the circle is 8 cm and the diameter of the semi-circle is 4 cm. Find the area of the shaded regions. (Take $\pi = 3.14$)

Do not write in this column

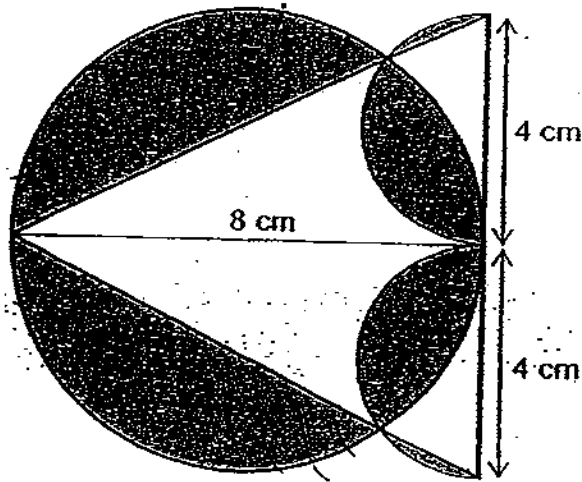

Ans: _____ [5]

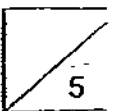

17. Ahmad and Halim together took 5 days to paint their house. If Ahmad and Halim work together for 2 days, followed by Ahmad working alone for 8 days, Halim will take 1 more day to complete the remaining work. How long will Ahmad take to paint the house all by himself?

Do not write
in this column

Ans: _____ [5]

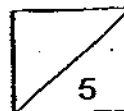

18. Tracy counted the number of 10-¢ coins, 20-¢ coins and 50-¢ coins in her piggy bank. The number of 10-¢ coins was 24 more than the number of 50-¢ coins. After spending $\frac{3}{5}$ of the 10-¢ coins, $\frac{1}{4}$ of the 20-¢ coins and 18 50-¢ coins, she had an equal number of 10-¢ and 20-¢ coins. The number of 50-¢ coins now formed 40% of the remaining number of coins

Do not write
in this column

- (a) How many 10-¢ coins did Tracy have at first?
(b) How much did she spend in all?

Ans: (a) _____ [3]

(b) _____ [2]

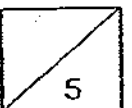

END OF PAPER

— CHECK YOUR WORK CAREFULLY —

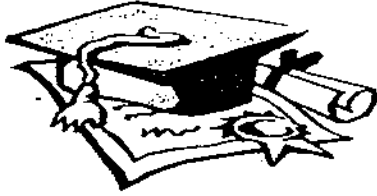

ANSWER SHEET

EXAM PAPER 2009

SCHOOL : SCGS PRIMARY
SUBJECT : PRIMARY 6 MATHEMATICS

TERM : SA2

Q1	Q2	Q3	Q4	Q5	Q6	Q7	Q8	Q9	Q10	Q11	Q12	Q13	Q14	Q15
3	1	2	1	2	2	3	4	1	2	3	3	4	2	3

16) $3/10, 3/8, 7/12, 5/6$ 17) $2\frac{3}{4}$ 18) $5/8$ 19) 11:9

20) 13 21) \$45 22) 27th September 23) 58cm 24) $1/20$

25) 100° 26) 14cm 27) 15cm 28) \$7 29) $n-4/2$ 30) 20%

Paper 2

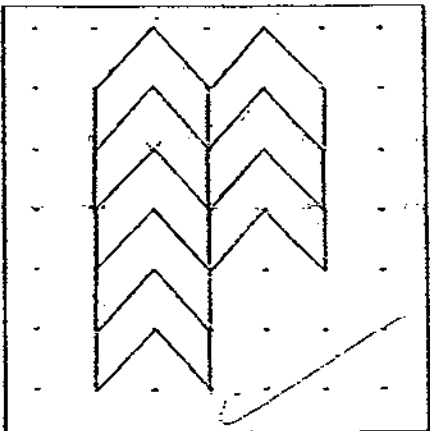
1) $6p - \$13.6 - \$1.60 = \$12$ $1p - \$12 \div 6 = \2	2) 600g
3) 	4) $50^\circ + 70^\circ = 120^\circ$

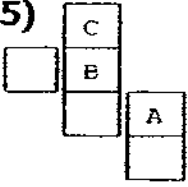
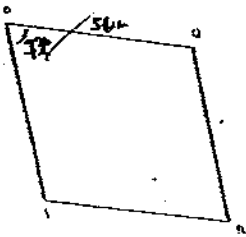
<p>5)</p> 	<p>6) \$36</p>
<p>7) $36000 + 12000 = 48000 \text{ cm}^3$ $48 \times 25 + 60 \times 30 = 3000 \text{ cm}^2$ $48000 \div 3000 = 16 \text{ cm}$</p>	<p>8)</p> 
<p>9) local \rightarrow 60% (30) (20%) Foreign \rightarrow 40\$ (20) (80%) 80\$ \rightarrow 20 20% \rightarrow 5</p>	<p>10) a) $(24 \times 2) + 4 = 52$ b) $109 - 1 = 108$ $108 \div 3 = 36$</p>
<p>11) $100 \div 4 = 25 \text{ cm}^2$ $100 - 25 = 75 \text{ cm}^2$ $25 / 175 = 1/7$ a) 25 cm^2 b) $1/7$</p>	<p>12) $480 \div 80 \text{ m/min} = 6 \text{ min}$</p>
<p>13) $46 \times 54 \times 20 = 49680 \text{ cm}^3$ $50 \times 42 \times 18 = 37800 \text{ cm}^3$ $49680 - 37800 = 11880 \text{ cm}^3$</p>	<p>14) 42</p>
<p>15) 66</p>	<p>16) 30.8 cm^2</p>
<p>17) $17 \frac{1}{2}$</p>	<p>18) a) 90 b) \$16.80</p>