



Rosyth School
Semestral Assessment 1 2017
Primary 6 Mathematics

Name: _____ Register No. _____

Class: Pr 6 - _____

Date: 8 May 2017

Parent's Signature: _____

Total Time for Booklets A and B : 50 minutes

**PAPER 1
(Booklet A)**

Instructions to Pupils:

1. Do not open this booklet until you are told to do so.
2. Follow all instructions carefully.
3. Shade your answers in the Optical Answer Sheet (OAS) provided.
4. You are **not** allowed to use a calculator.
5. Answer all questions.

Section	Maximum Mark	Marks Obtained
Paper 1 (Booklet A)	20	

This booklet consists 8 printed pages (including this cover page)

Questions 1 to 10 carry 1 mark each. Questions 11 to 15 carry 2 marks each. For each question, four options are given. One of them is the correct answer. Make your choice (1, 2, 3 or 4). Shade the oval (1, 2, 3 or 4) on the Optical Answer Sheet.

All diagrams in this paper are not drawn to scale.

(20 marks)

1. A shop sold \$413 098 of goods in June. Express this number to the nearest thousand.

- (1) \$400 000
- (2) \$410 000
- (3) \$413 000
- (4) \$414 000

2. What is the value of $20 \div 5000$?

- (1) 0.004
- (2) 0.04
- (3) 0.25
- (4) 250

3. Felicia used black and white beads to make a chain as shown below. What fraction of the beads used are black?



- (1) $\frac{1}{3}$
- (2) $\frac{1}{2}$
- (3) $\frac{2}{3}$
- (4) $\frac{3}{4}$

4. Express $1\frac{5}{25}$ as a decimal.
- (1) 1.15
 - (2) 1.2
 - (3) 1.25
 - (4) 1.525
5. There are 78 canned drinks in a carton. 24 are mango flavoured and the rest are lychee flavoured. What is the ratio of the mango flavoured drinks to the number of lychee flavoured drinks?
- (1) 4 : 9
 - (2) 9 : 4
 - (3) 4 : 13
 - (4) 9 : 13
6. Nora had \$30y. She bought a dress for \$5y. She also bought a skirt that cost \$2y more than the dress. How much had she left? Express your answer in terms of y.
- (1) \$7y
 - (2) \$12y
 - (3) \$18y
 - (4) \$ 23y
7. Express 3 kg 30 g in g.
- (1) 303 g
 - (2) 330 g
 - (3) 3 030 g
 - (4) 3 300 g

8. Adeline started reading at 10.50 am. She read for 2 hours 25 minutes. At what time did she stop reading?

- (1) 12.15 p.m.
- (2) 12.25 p.m.
- (3) 12.50 p.m.
- (4) 1.15 p.m.

9. In the figure, AB and CD are straight lines. Which of the following angles is equal to 130° ?

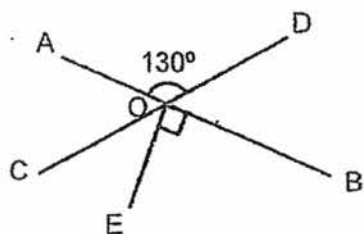

- (1) $\angle EOA$
- (2) $\angle EOD$
- (3) $\angle DOB$
- (4) $\angle COB$

10. The figure is made up of rectangle ABCD and triangle EBD. DC is 22 cm, AD is 10 cm and AE = AD. Find the area triangle EBD.

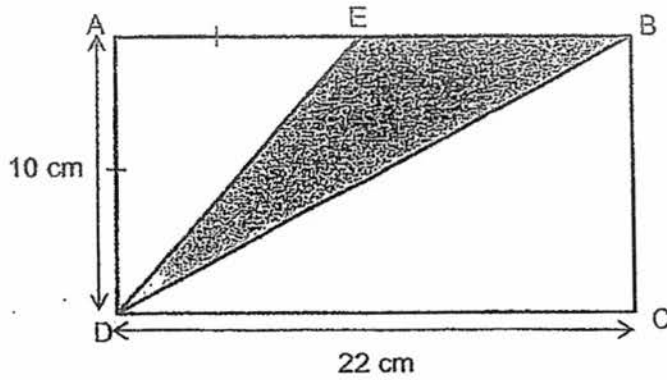

- (1) 50 cm²
 (2) 60 cm²
 (3) 110 cm²
 (4) 120 cm²
11. The figure below is a circle made up of 4 parts, A, B, C, and D. O is the centre of the circle. Part A has the same area as Part B. The ratio of the area of Part A to the area of part C is 3 : 2. Which of the following fractions cannot be represented by the sum of at least two of the parts?

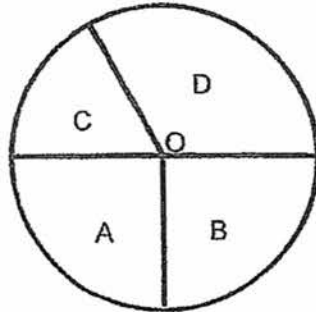

- (1) $\frac{7}{12}$
 (2) $\frac{3}{8}$
 (3) $\frac{5}{6}$
 (4) $\frac{2}{3}$

(Go on to the next page.)

12. Carmen spent \$60 of her allowance each month and saved the rest. When she increased her spending by 20%, her savings decreased by 25%. How much was Carmen's allowance?

- (1) \$72
- (2) \$96
- (3) \$108
- (4) \$117

13. The 2 solids below are made up of 1-cm cubes.

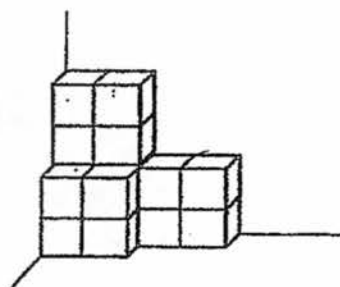

Figure A

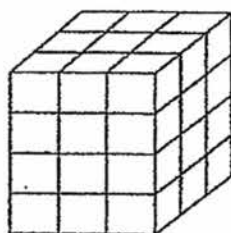
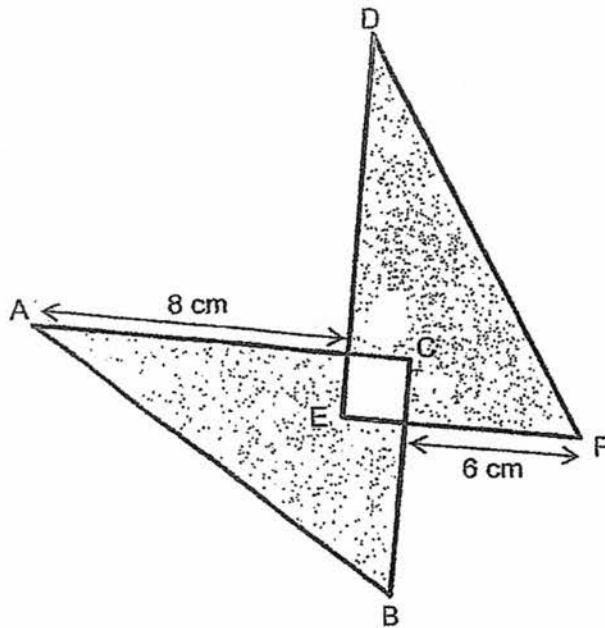

Figure B

How many 1-cm cubes are needed to be added to Figure A so that it has the same volume as Figure B?

- (1) 11
- (2) 16
- (3) 20
- (4) 36

14. In the figure, ABC and DEF are identical right-angled triangles which overlapped each other to form a square of side 2 cm. Find the area of the shaded part.



- (1) 40 cm^2
- (2) 72 cm^2
- (3) 76 cm^2
- (4) 80 cm^2

15. The figure below is made up of a big square with an area of 64 cm^2 and two identical smaller squares of area 36 cm^2 each. Find the perimeter of the figure.

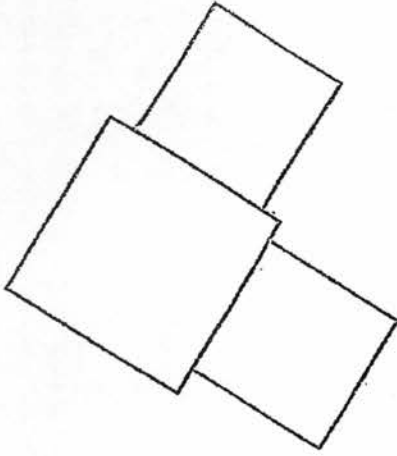

- (1) 52 cm
- (2) 56 cm
- (3) 68 cm
- (4) 80 cm



**Rosyth School
Semestral Assessment 1 2017
Primary 6 Mathematics**

Name: _____ Register No. _____

Class: Pr 6 - _____

Date: 8 May 2017 Parent's Signature: _____

Total Time for Booklets A and B : 50 minutes

**PAPER 1
(Booklet B)**

Instructions to Pupils:

1. Do not open this booklet until you are told to do so.
2. Follow all instructions carefully.
3. You are **not** allowed to use a calculator.
4. Answer all questions.

Section	Maximum Mark	Marks Obtained
Paper 1 (Booklet B)	20	

This booklet consists of 8 printed pages (including this cover page).

Questions 16 to 25 carry 1 mark each. Write your answers in the spaces provided. For questions which require units, give your answers in the units stated. (10 marks)

Do not write in this space

All diagrams in this paper are not drawn to scale unless stated otherwise.

16. Write down all the common multiples of 6 and 8 that are smaller than 60.

Ans: _____

17. 12 : 45 is the same as ____ : 30.
The missing number in the blank is ____.

Ans: _____

18. The average of 4 numbers is 38. When one of the numbers is removed, the sum of the remaining numbers becomes 108. What is the number that was removed?

Ans: _____

19. Alicia had $\frac{4}{5}$ kg of sugar in a container. She used $\frac{1}{3}$ of the sugar to bake a cake. How much sugar was left in the container? Leave your answer as a fraction in the simplest form.

Do not write
in this space

Ans: _____ kg

20. Amina had 12 kg of sugar and Sally had 8 kg of sugar. After both girls used the same amount of sugar, Amina had 3 times as much sugar as Sally. How many kilograms of sugar had Sally left?

Ans: _____ kg

21. The table below shows the parking charges at a carpark.

1 st hour	\$2
Every additional $\frac{1}{2}$ hour or part thereof	\$1

Mr Wong parked his car from 3.30 p.m. to 5.15 p.m. How much did he have to pay?

Ans: \$ _____

22. The figure is made up of a semicircle and a quadrant. Find the area of the figure. (Take $\pi = \frac{22}{7}$)

Do not write in this space

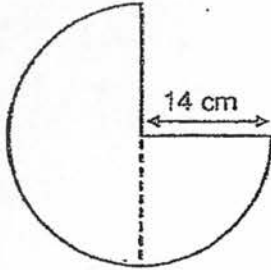

Ans: _____ cm²

23. Find the value of $\angle y$.

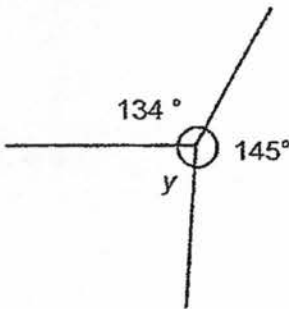

Ans: _____ °

24. The container below is partially filled with water. How much more water is needed to fill the container completely?

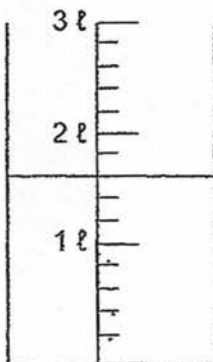

Ans: _____ l

25. In the figure, ABC is an equilateral triangle and $AC = CD$. Find the value of $\angle x$.

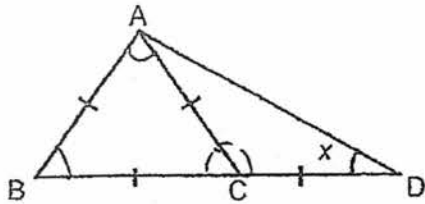

Do not write
in this space

Ans: _____ °

Questions 26 to 30 carry 2 marks each. Show your workings clearly in the space provided for each question and write your answers in the spaces provided. For questions which require units, give your answers in the units stated.

Do not write
in this space

(10 marks)

All diagrams in this paper are not drawn to scale unless stated otherwise.

26. Chee Kong takes 2 hours to drive from Town A to Town B. He takes another 3 hours to drive from Town B to Town C. The distance between Town A and Town B is 90 km while the distance between Town B and Town C is 180 km. What is Chee Kong's average speed for the whole journey?

Ans: _____

27. Kelly spent \$18 on some pens and markers. She bought 5 more pens than markers. Each marker cost \$1.80 and each pen cost \$1.20. How many markers did Kelly buy?

Ans: _____

28. There are 3 types of fruits in a box.
 The ratio of the number of apples to the number of pears is 3 : 5.
 The ratio of the number of oranges to the total number of apples and pears is 1 : 6.
 What fraction of the fruits in the box is pears? Leave your answer in the simplest form.

Do not write
in this space

Ans: _____ cm

29. The figure below is made up of 2 identical quadrants of radius 14 cm. Find the perimeter of the shaded part. (Take $\pi = \frac{22}{7}$)

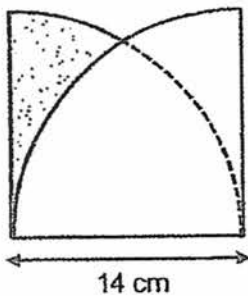

Ans: _____ cm
km/h

30. In the figure below, ABCD is a parallelogram and BEFC is a rhombus. $\angle ABC$ is 70° , $\angle ACF$ is 170° and $\angle BEF$ is 125° . Find $\angle BAC$.

Do not write
in this space

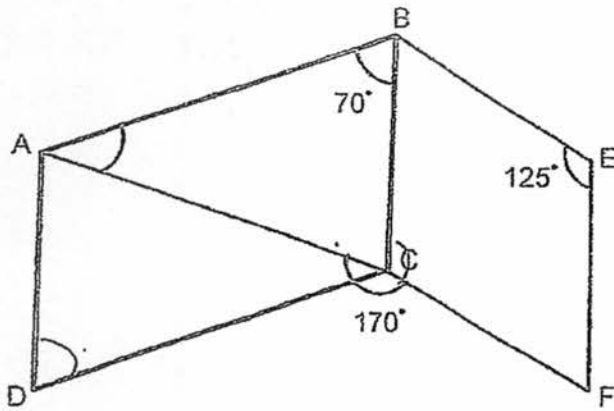

Ans : _____ $^\circ$

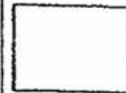

End of paper 1. Have you checked your work?



Rosyth School
Semestral Assessment 1 2017
Primary 6 Mathematics

Name: _____ Register No. _____

Class: Pr 6 - _____

Date: 8 May 2017

Parent's Signature: _____

Time: 1h 40min

PAPER 2

Instructions to Pupils:

1. Do not open this booklet until you are told to do so.
2. Follow all instructions carefully.
3. **Show your workings clearly** as marks are awarded for correct working.
4. Write your answers in this booklet.
5. You are allowed to use a calculator.
6. Answer all questions.

Questions	Maximum Mark	Marks Obtained
Q 1 to 5	10	
Q 6 to 18	50	

Section	Maximum Mark	Marks Obtained
Paper 1	40	
Paper 2	60	
Total	100	

* This booklet consists of 18 printed pages (including this cover page)

Questions 1 to 5 carry 2 marks each. Show your working clearly in the space provided for each question and write your answers in the spaces provided. For questions which require units, give your answers in the units stated.

(10 marks)

Do not write
in this space

All diagrams in this paper are not drawn to scale unless stated otherwise.

1. Debra and Giselle have some playing cards. After Giselle gives 21 playing cards to Debra, Debra has 40 more playing cards than Giselle.

- (a) Who had more playing cards at first?
(b) How many more?

Ans: _____

Ans: _____

2. Carol had some money. She spent $\frac{2}{5}$ of it to buy a ring and $\frac{1}{7}$ of it to buy a wallet. The ring and the wallet cost \$136.80 altogether. How much money had she left?

Ans: \$ _____

3. Vani mounted 2 similar-sized photographs with a space of 3 cm all around each photograph onto a frame as shown in the diagram. Find the area of the frame that is not covered by the 2 photographs.

Do not write
in this space

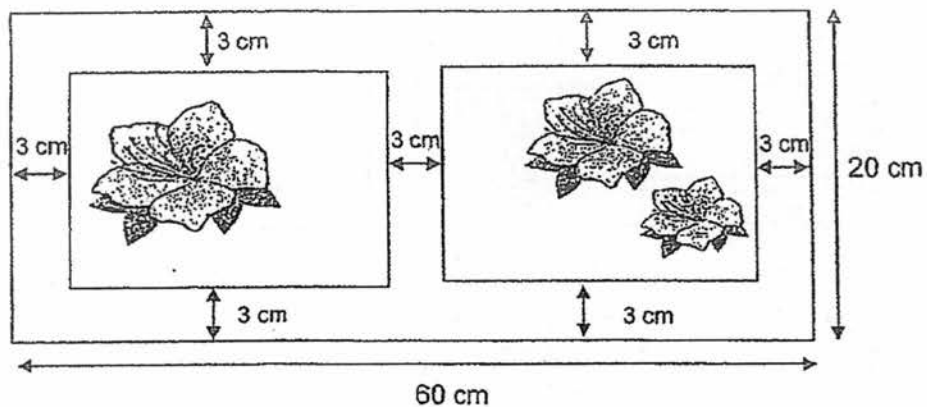

Ans: _____ cm²



4. The rectangular tank shown below contains 16 l of water. Find the height of the water level in the tank.

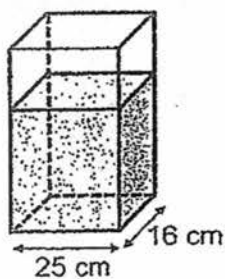

Ans: _____ cm

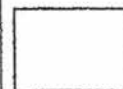

5. In the square grid, two sides of a parallelogram ABCD have been drawn. Complete the drawing of the parallelogram ABCD.

Label your drawing.

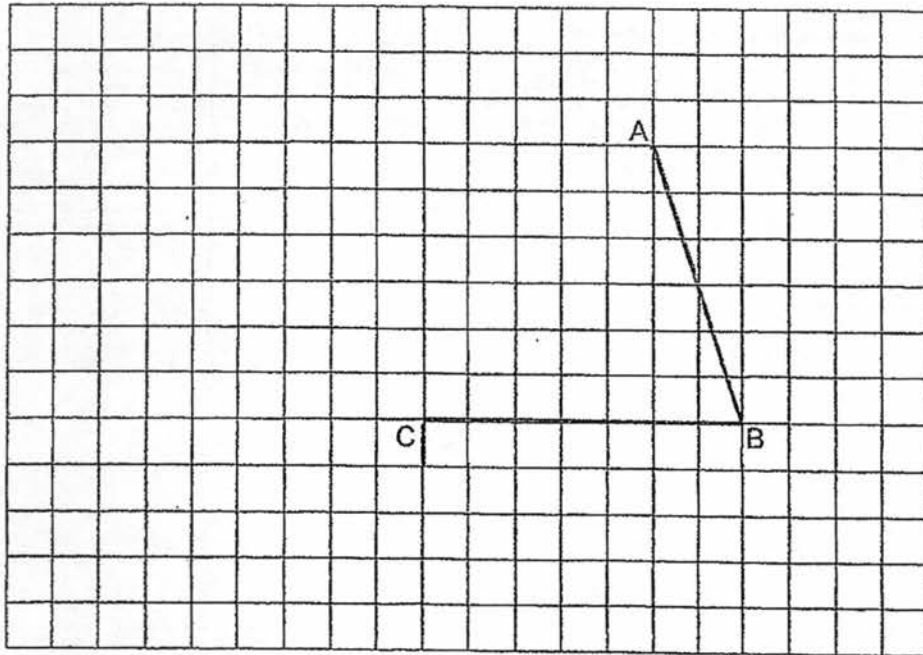

Do not write
in this space

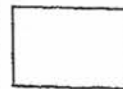

For Questions 6 to 18, show your working clearly in the space provided for each question and write your answers in the spaces provided. The number of marks available is shown in brackets [] at the end of each question or part-question. For questions which require units, give your answers in the units stated.

Do not write in this space

All diagrams in this paper are not drawn to scale unless stated otherwise.
(50 marks)

6. A factory produced 60 000 cars over 7 days. The line graph shows the number of cars made in the factory over 6 days.

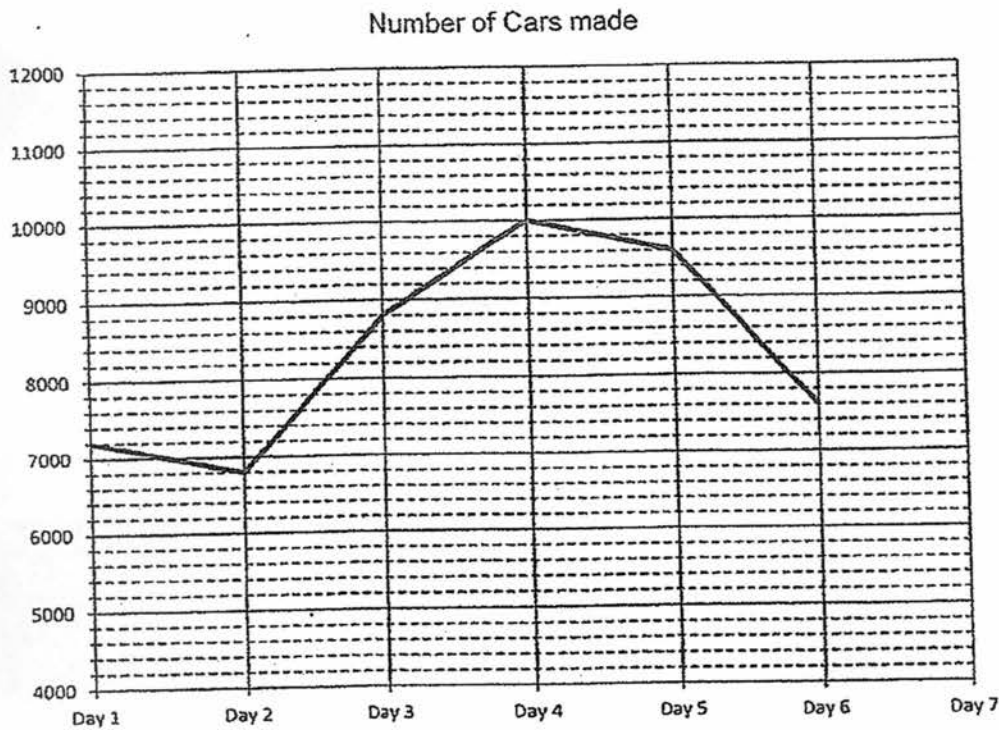

- (a) What is the ratio of the number of cars produced on the 4th day to the total number of cars produced over the seven days? Express your answer in the simplest form.
- (b) How many cars were made in the factory on day 7?

Ans: (a) _____ [1]
(b) _____ [2]

7. The outline of the figure below is formed by 2 identical large quarter circles, 2 identical small quarter circles and 3 straight lines. The length of $AB = BD$. The length of AC is 42 cm. Find the area of the shaded figure. Use the calculator value of π and correct your answer to 2 decimal places.

Do not write
in this space

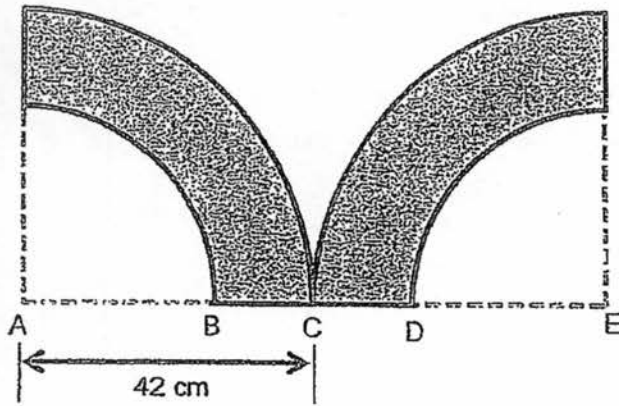

Ans: _____ [3]

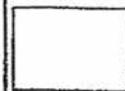

8. Deo has 840 green beads. Ian has 960 red beads. Deo places 70% of his green beads into a box. Ian also places 70% of his red beads into the same box. What percentage of the beads in the box are red? Express your answer correct to 2 decimal places.

Do not write
in this space

Ans: _____ [3]

9. At first, Alynna had a total of 86 toy cars and toy dolls. She gave away 38 toy cars and increased the number of toy dolls by 25%. After that, Alynna had a total of 60 toy cars and toy dolls. How many toy dolls did she have at first?

Do not write
in this space

Ans: _____ [3]

10. Shi Yao had a total of 868 red pens and blue pens. After selling an equal number of both types of pen, she had $\frac{1}{4}$ of the red pens and $\frac{1}{5}$ of the blue pens left. What was the total number of blue and red pens left?

Do not write
in this space

Ans: _____ [3]

11. During the annual Prize Giving ceremony, the ratio of the number of gift cards to the number of cash vouchers the school prepared was 5 : 3. Each class received 4 gift cards and 5 cash vouchers. After all the classes had received their gift cards and cash vouchers, there were no more cash vouchers left but there were 78 gift cards left. How many cash vouchers were given out to all the classes?

Do not write
in this space

Ans: _____ [3]

12. At first a tank was $\frac{1}{5}$ filled with water. Two taps, A and B were used to fill up the tank. For the first 20 minutes, only tap A was turned on. The tank was half-filled with water after 20 minutes.

- (a) How many litres of water were added to the tank by tap A in the first 20 minutes?
- (b) Tap B was also turned on after 20 minutes. The tank was completely filled with water from tap A and tap B 15 minutes later. How many litres of water flowed out from Tap B in 1 minute?

Do not write
in this space

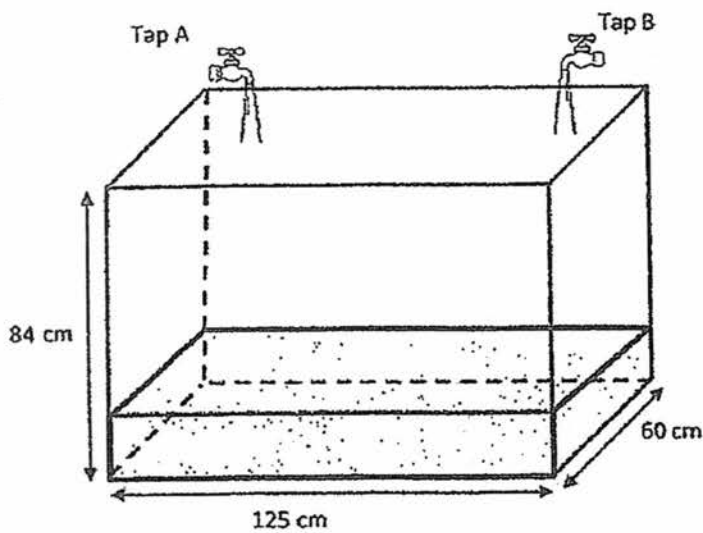

Ans (a): _____ [2]

(b): _____ [2]

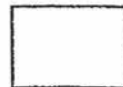

13. The figure ABCD is a square. 4 straight lines BCF, BGE, CGH and EDF are drawn to complete the figure shown below. AED is an isosceles triangle and $BG = BC$. $\angle CBG$ is 54° .

Do not write
in this space

- (a) Find $\angle ABG$.
(b) Find $\angle CFD$.

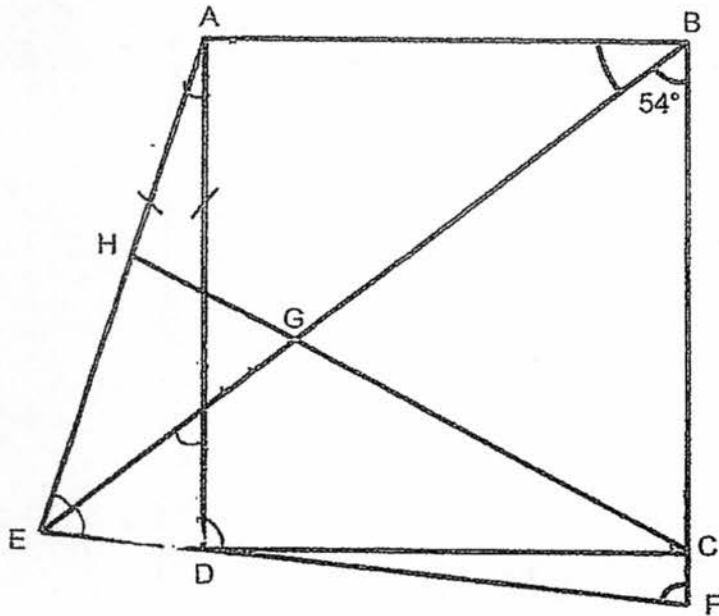

Ans (a): _____ [1]

(b): _____ [3]

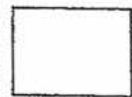

14. Box A contains only red pens and Box B contains only blue pens. There were twice as many red pens as blue pens. $\frac{1}{2}$ of the red pens were transferred into box B. At the same time, $\frac{2}{3}$ of the blue pens were transferred into box A.

Do not write
in this space

- (a) What fraction of the pens in box A after the transfer are red?
- (b) After the transfer, 8 blue pens and 5 red pens were moved from Box A to Box B. The 2 boxes then had the same number of pens. How many blue pens were there?

Ans (a): _____ [1]

(b): _____ [3]

15. Michelle and her classmates made identical paper stars to sell for charity. They made 4 paper stars from each piece of the coloured paper. 3 paper stars were damaged for every 16 pieces of coloured paper that were used. Each paper star that was not damaged was sold for 40 cents. They collected a total of \$317.20.

(a) How many paper stars were sold?

(b) How many pieces of the coloured paper did they use altogether?

Do not write
in this space

Ans (a): _____ [1]

(b): _____ [4]

16. Yilin bought a dress for \$117 after a 35% discount.

- (a) What was the price of the dress before the discount?
- (b) Yilin paid \$147.60 for a blouse. The total discount for the dress and the blouse was \$95.40. What was the percentage discount given for the blouse?

Do not write
in this space



Ans: (a) _____ [2]

(b) _____ [3]

17. Bryan designed a computer game where the enemy ships appeared in a fixed pattern over time as shown below.

Do not write in this space

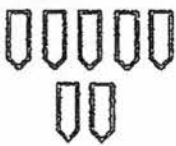
 1 enemy ship

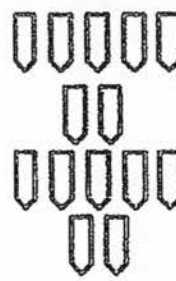
Start of Game	1 st Second	2 nd Second	3 rd Second
			
4 th Second	5 th Second	6 th Second	7 th Second

- (a) How many enemy ships will appear in the 5th second?
 (b) How many seconds after the game start would 124 enemy ships appear?
 (c) How many enemy ships will appear at the 1 minute mark?

Please use the next page for your answer

Do not write
in this space

Ans: (a) _____ [1]

(b) _____ [2]

(c) _____ [2]

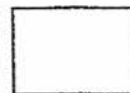

18. Mrs Teo bought 5 bags of rice and 5 bags of flour.
15 bags of rice weigh as much as 27 bags of flour. Each bag of rice weigh 2.6 kg more than each bag of flour.

- (a) What was the mass of each bag of rice?
- (b) What was the total mass of all the bags of rice and flour Mrs Teo bought?

Do not write
in this space

Ans: (a) _____ [3]

(b) _____ [2]

End of Paper

EXAM PAPER 2017 9 May 2017
 LEVEL : PRIMARY 6
 SCHOOL : ROSYTH PRIMARY SCHOOL
 SUBJECT : MATHEMATICS
 TERM : SEMESTRAL ASSESSMENT 1

Q1	Q2	Q3	Q4	Q5	Q6	Q7	Q8	Q9	Q10
3	1	1	2	1	3	3	4	4	2
Q11	Q12	Q13	Q14	Q15					
2	3	3	2	2					

Q16. 24 and 48 Q17. 8 Q18. 44 Q19. 8/15 Q20. 2 Q21. 4
 Q22. 462 Q23. 81 Q24. 1.4 Q25. 30 Q26. 54km/h
 Q27. 4 Q28. 15/28 Q29. 36 Q30. 45

PAPER 2

Q1. $21 \times 2 = 42$
 $42 - 40 = 2$ Answer: a) Giselle b) 2

Q2. $2/5 = 14/35$ $1/7 = 5/35$
 $14u + 5u = 19u$
 $19u \rightarrow 136.80$
 $1u \rightarrow 7.2$
 $16u \rightarrow 115.2$ Answer: 115.20

Q3. $20 - 6 = 14$
 $25.5 \times 14 = 357$
 $357 \times 2 = 714$
 $1200 - 714 = 486$ Answer: 486

Q4. $16000/16/25 = 40$ Answer: 40

Q5.



Q6. Answer: a) 1:6 b) 10000

Q7. $42/3 = 14$

$1u \rightarrow 14$

$3u \rightarrow 42$

$2u \rightarrow 28$

$28 \times 28 \times \frac{1}{4} \times \pi = 196\pi$

$42 \times 42 \times \frac{1}{4} \times \pi = 441\pi$

$441\pi \times 2 = 882\pi$

$196\pi \times 2 = 392\pi$

$882 - 392\pi = 490\pi$

$490\pi \rightarrow 1539.3804 \approx 1539.38$ Answer: 159.38cm^2

Q8. $840/100 = 8.4$

$814 \times 20 = 588$

$960/100 = 9.6$

$9.6 \times 20 = 672$

red $\rightarrow 672$

green $\rightarrow 588$

$588 + 672 = 1260$

$672/1260 \times 100 \approx 53.33$ Answer: 53.33%

Q9. $86 - 60 = 26$

$38 - 26 = 12$

$25\% \rightarrow 12$

$100\% \rightarrow 48$ Answer: 48

Q10. $12/36R = 12/15B$

$868/31 = 28$

$1u \rightarrow 28$

$4u + 3u = 7u$

$7u \rightarrow 196$ Answer: 196

Q11. $15/5 = 3$

$3 \times 4 = 12$

$25 - 12 = 13$

$78/13 = 6$

$6 \times 15 = 90$

Q12. $84 \times 125 = 630000$

$630000\text{ml} = 630\text{L}$

$630\text{L}/5 = 126\text{L}$

$315\text{L}/2 = 315$

$315\text{L} - 126\text{L} = 189\text{L}$

$189\text{L}/20 = 9.45\text{L}$

$189000/20 = 9450$

$9450 \times 15 = 141750$

$$315000 - 141750 = 173250$$

$$173250/15 = 11550L = 11.55ml \quad \text{Answer: a) 189L} \quad \text{b) 11.5L}$$

$$\text{Q13. } 90 - 54 = 36$$

$$180 - 90 - 54 = 36$$

$$(180-110)/2 = 35$$

$$110 - 90 = 20$$

$$360 - 64 - 35 - 90 - 36 - 54 = 81 \quad \text{Answer: a) } 36^\circ \quad \text{b) } 81^\circ$$

$$\text{Q14. Red B: Blue B} = 6:2 \quad \text{Red A:Blue A} = 2:1 - 6:3 - 5:4$$

$$3 + 2 = 5$$

$$8 + 5 = 13$$

$$1u \rightarrow 13$$

$$6u \rightarrow 78 \quad \text{Answer: a) } 3/5 \quad \text{b) } 78$$

$$\text{Q15. } 317.20/0.4 = 793$$

$$16 \times 4.3 = 61$$

$$793/61 = 15$$

$$13 \times 16 = 208 \quad \text{Answer: a) } 793 \quad \text{b) } 208$$

$$\text{Q16. } 100 - 35 = 65$$

$$117/64 = 1.8$$

$$1.8 \times 100 = 180$$

$$1.8 \times 35 = 63$$

$$95.40 - 63 = 32.40$$

$$147.60 + 32.4 = 180$$

$$180/100 = 1.8$$

$$32.4/1.8 = 18 \quad \text{Answer: a) } \$180 \quad \text{b) } 18\%$$

$$\text{Q17. } 5 + 2 = 7$$

$$5 + 2 + 5 + 2 + 5 + 2 = 21$$

$$124/7 = 17R5$$

$$(17 \times 7) / 5 = 124$$

$$(5 + 2 + 5 + 2 + 5 \dots + 2 + 5) \times 61 = 215 \quad \text{Answer: a) } 21 \quad \text{b) } 34^{\text{th}} \quad \text{c) } 215$$

$$\text{Q18. } 2.6 \times 15 = 39$$

$$39/12 = 3.25$$

$$3.25 + 2.6 = 5.85$$

$$R \rightarrow 5.85$$

$$F \rightarrow 3.25$$

$$3.25 \times 5 = 16.25$$

$$5.85 \times 5 = 29.25$$

$$29.25 + 16.25 = 45.5 \quad \text{Answer: a) } 5.85 \quad \text{b) } 45.5\text{kg}$$

