

16

SINGAPORE CHINESE GIRLS' SCHOOL
FIRST SEMESTRAL ASSESSMENT 2016

PRIMARY 6

MATHEMATICS
PAPER 1

BOOKLET A

Name : _____ (.)

Class : Primary 6 SY/C/G/SE/P

		Marks attained	Max Mark
Paper 1	Booklet A		20
	Booklet B		20
Paper 2			60
Total Marks			100

Parent's Signature

15 Questions
20 Marks

Total Time for Booklets A and B: 50 min

INSTRUCTIONS TO CANDIDATES

Do not open this booklet until you are told to do so.

Follow all instructions carefully.

Answer all questions.

You are **not allowed** to use a calculator

Booklet A

Questions 1 to 10 carry 1 mark each. Questions 11 to 15 carry 2 marks each.
For each question, four options are given. One of them is the correct answer.
Make your choice (1, 2, 3 or 4). Shade the correct oval (1, 2, 3 or 4) on the Optical Answer Sheet. **(20 marks)**

1 How many thousands are there in 3 500 000?

- (1) 35 000
- (2) 3 500
- (3) 350
- (4) 35

2 The table below shows the time taken by four swimmers during a competition. Who came in first?

Swimmer	Time in seconds
Alex	31.6
Benjamin	30.9
Carl	33.8
Darren	35.7

- (1) Alex
- (2) Benjamin
- (3) Carl
- (4) Darren

3 $5 + \frac{7}{10} + \frac{3}{1000} =$ _____

- (1) 5.73
- (2) 5.073
- (3) 5.703
- (4) 5.0073

4 Which one of the following is not an equivalent fraction of one another?

(1) $\frac{2}{3}$

(2) $\frac{4}{12}$

(3) $\frac{6}{9}$

(4) $\frac{10}{15}$

5 Arrange the following fractions from the largest to the smallest.

$$\frac{5}{11}, \frac{1}{5}, \frac{5}{10}$$

(1) $\frac{1}{5}, \frac{5}{10}, \frac{5}{11}$

(2) $\frac{5}{10}, \frac{5}{11}, \frac{1}{5}$

(3) $\frac{5}{10}, \frac{1}{5}, \frac{5}{11}$

(4) $\frac{5}{11}, \frac{5}{10}, \frac{1}{5}$

6 Which of the following is **TRUE**?

(1) $\frac{8}{10}$ is 8%

(2) 0.58 is 5.8%

(3) 25% of \$200 is \$100

(4) 45% is the same as $\frac{9}{20}$

7 What is the value of $(2 \times 2 + 2 + 2 \times 2 - 2 \times 2) \div 2$?

- (1) 0
- (2) 8
- (3) 3
- (4) 14

8 Simplify $9 + 6a - 4 + 2a$.

- (1) $8a + 13$
- (2) $8a + 5$
- (3) $4a + 13$
- (4) $4a + 5$

9 In the figure shown below not drawn to scale, $AD = AB$ and BCD is an equilateral triangle. CDE is a straight line. Find $\angle ADE$.

- (1) 35°
- (2) 60°
- (3) 85°
- (4) 95°

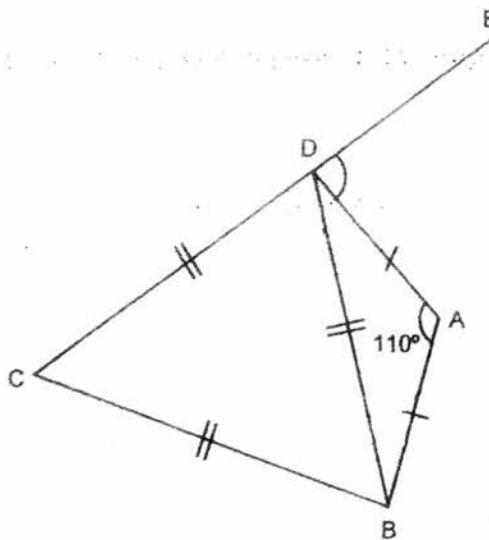

- 10 In 82.34, what does the digit 3 represent?
- (1) 3 ones
 - (2) 3 tens
 - (3) 3 tenths
 - (4) 3 hundredths
- 11 Tim is $1\frac{3}{4}$ m tall. Joey is 1.25 m tall. What is the ratio of Tim's height to Joey's height?
- (1) 3 : 1
 - (2) 3 : 25
 - (3) 7 : 5
 - (4) 13 : 11
- 12 In a pet house, $\frac{5}{8}$ of the pets are rabbits and the rest are hamsters. $\frac{7}{10}$ of the rabbits are grey. There are 28 grey rabbits. How many pets are there in the pet house?
- (1) 12
 - (2) 24
 - (3) 40
 - (4) 64

13 Sarah, Rekah and Megan shared \$900. Rekah received 20% more than Sarah while Megan received 20% less than Sarah. How much did Sarah receive?

- (1) \$100
- (2) \$240
- (3) \$300
- (4) \$360

14 What is the 854th number in the following series?

1, 2, 4, 6, 8, 1, 2, 4, 6, 8, 1, 2, 4, 6, 8, 1, 2, ...

- (1) 6
- (2) 2
- (3) 8
- (4) 4

15 Find the difference between $(\frac{1}{2} \times 6)$ and $(\frac{2}{3} \div 4)$.

- (1) $\frac{1}{6}$
- (2) $\frac{1}{3}$
- (3) $2\frac{2}{3}$
- (4) $2\frac{5}{6}$

SINGAPORE CHINESE GIRLS' SCHOOL

FIRST SEMESTRAL ASSESSMENT 2016

PRIMARY 6

MATHEMATICS
PAPER 1

BOOKLET B

Name : _____ ()

Class : Primary 6 SY/C/G/SE/P

Paper 1	Mark attained	Max Mark
Booklet B		20

15 Questions
20 Marks

Total Time for Booklets A and B: 50 min

INSTRUCTIONS TO CANDIDATES

Do not open this booklet until you are told to do so.

Follow all instructions carefully.

Answer all questions.

You are **not allowed** to use a calculator

Booklet B

Name: _____ () Class: P6 SY/C/G/SE/P

Do not write
in this
column

Questions 16 to 25 carry 1 mark each. Write your answers in the spaces provided.
For questions which require units, give your answers in the units stated. (10 marks)

16 Round off 6.521 to 2 decimal places.

Ans: _____

17 Find the value of $8 + \frac{2}{3}$.

Ans: _____

18 What is the product of the first two common multiples of 2 and 6?

Ans: _____

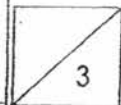

- 19 The figure below is made of squares. It has a line of symmetry as shown. Shade 4 more squares to complete the symmetric figure.

Do not write
in this
column

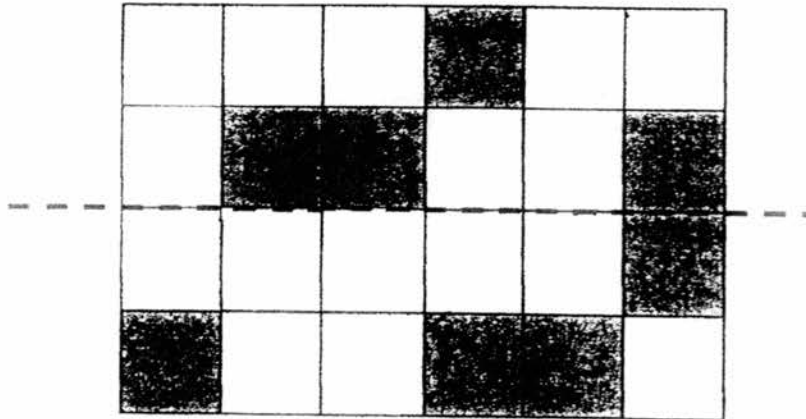

- 20 Express 3.6 as percentage.

Ans: _____ %

- 21 Find the value of $\frac{9q+4}{4}$ when $q = 8$.

Ans: _____

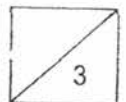

- 22 The figure below is not drawn to scale. It is made up of a square and a rectangle. Given that $\angle b$ is twice of $\angle a$, find $\angle a$.

Do not write
in this
column

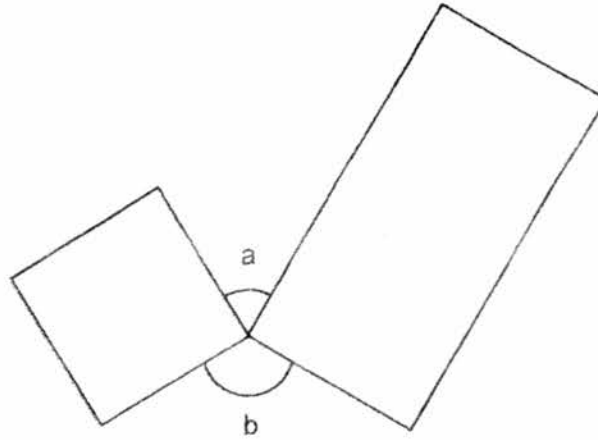

Ans: _____

- 23 Timothy fills a 2.4 l bottle with water from a tap. In one minute, 120 ml of water flows from the tap. How long does he take to fill the bottle?

Ans: _____ min

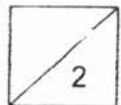

- 24 Find the volume of the water in the tank.

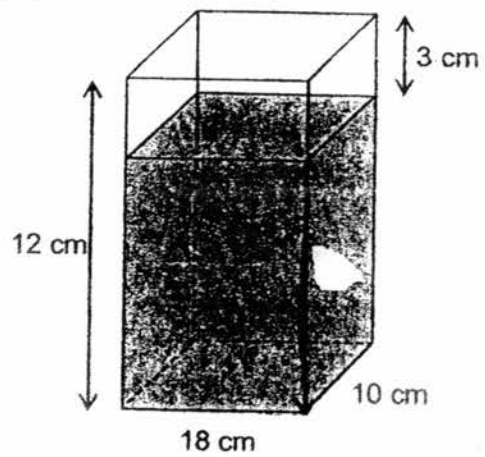

Do not write
in this
column

Ans. _____

- 25 The ratio of the sides of two squares is 3 : 4. Find the ratio of area of big square to area of small square.

Ans. _____

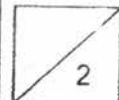

Questions 26 to 30 carry 2 marks each. Show your working clearly in the space for each question and write your answers in the space provided.
For questions which require units, give your answers in the units stated.

Do not write
in this
column

(10 marks)

- 26 Kym spent $\frac{1}{6}$ of her money on a birthday present and $\frac{2}{5}$ of the remainder on books. If she spent \$320 on books, how much money does she have at first?

Ans: \$ _____

- 27 A carton can hold either 8 big boxes or 24 small boxes. If a shop assistant has already put 6 small boxes and 3 big boxes into the carton, how many more big boxes can he put into the carton?

Ans: _____

- 28 100 lamp posts were placed at an equal distance of y m apart. Find the distance between the first and the last lamp posts.
(Leave your answer in terms of y .)

Ans: _____ m

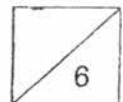

- 29 After giving away 45 marbles to his brother, Allan had $\frac{2}{3}$ of his marbles left. He then packed the remaining marbles into bags of 6. How many bags of marbles did Allan have?

Do not write
in this
column

Ans: _____

- 30 In the figure below, ACDE and AGDF are identical rectangles measuring 16 cm by 5 cm. Given that GB = BD. Find the area of triangle ABD.

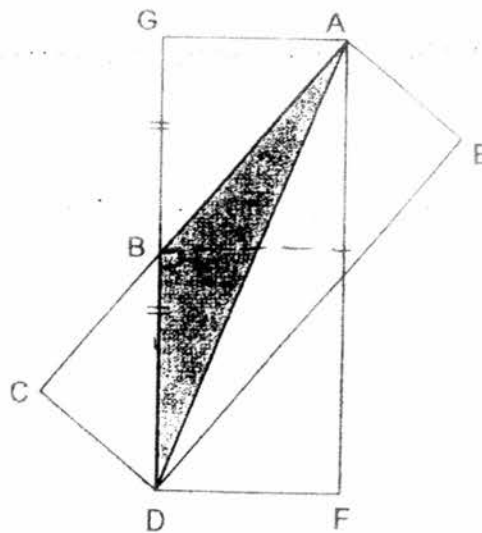

Ans: _____ cm²

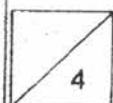

SINGAPORE CHINESE GIRLS' SCHOOL

FIRST SEMESTRAL ASSESSMENT 2016

PRIMARY 6

MATHEMATICS

PAPER 2

Name : _____ ()

Class : Primary 6 SY/C/G/SE/P

	Mark	Max Mark
Paper 2		60

Parent's Signature

18 Questions
60 Marks

Total Time for Paper 2: 1 h 40 min

INSTRUCTIONS TO CANDIDATES

Do not open this booklet until you are told to do so.

Follow all instructions carefully.

Answer all questions.

You **are allowed** to use the calculator

Questions 1 to 5 carry 2 marks each. Show your working clearly in the space below each question and write your answers in the space provided. For questions which require units, give your answers in the units stated. (10 marks)

Do not write in this column

1 Darren bought 3 tables and 6 chairs for \$367.20. Each table cost twice as much as a chair. Find the cost of a table.

Ans: \$ _____

2 Mr Wee spent 25% of his salary on a suitcase and half of the rest of his salary on his house loan. He had \$825 left. What is Mr Wee's salary?

Ans: \$ _____

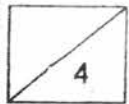

- 3 An ice cream stall sells ice-cream with peanut and blueberries toppings. Tiffany may choose from no topping to 2 toppings per ice-cream. The toppings cannot be repeated. How many different combinations of ice-cream can she order?

Do not write
in this
column

Ans: _____

- 4 Study the pattern of the figures below. How many coloured squares will there be when there are 30 white squares?

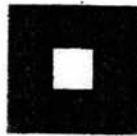

Pattern 1

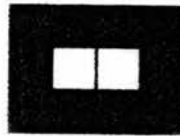

Pattern 2

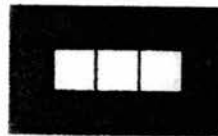

Pattern 3

Ans: _____

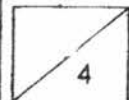

5. In a competition, 37 pupils received bronze and silver. 58 pupils received silver and gold. Find the difference between the number of pupils who received bronze and gold.

Do not write
in this
column

Ans: _____

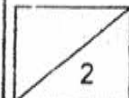

Questions 6 to 18, show your working clearly in the space below each question and write your answers in the space provided. The number of marks awarded is shown in the brackets [] at the end of the question or part-question.

Do not write
in this
column

(50 marks)

- 6 Madeline packed some cookies into two bottles A and B. She packed $\frac{3}{4}$ as many cookies into Bottle A as Bottle B at first. After transferring 24 cookies from Bottle A to Bottle B, there are now $\frac{1}{4}$ as many cookies into Bottle A as Bottle B. How many more cookies were there in Bottle B than Bottle A at first?

Ans : _____ [3]

- 7 300 people helped out in a carnival. When $\frac{3}{4}$ of the men and $\frac{3}{5}$ of the women left the carnival, the total number of people left at the carnival became 90. How many women helped out at the carnival at first?

Ans : _____ [3]

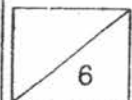

- 8 A tank was $\frac{1}{8}$ filled with water. The line graph below shows volume of water in the tank over 15 minutes. How long more does it take to fill the tank fully?

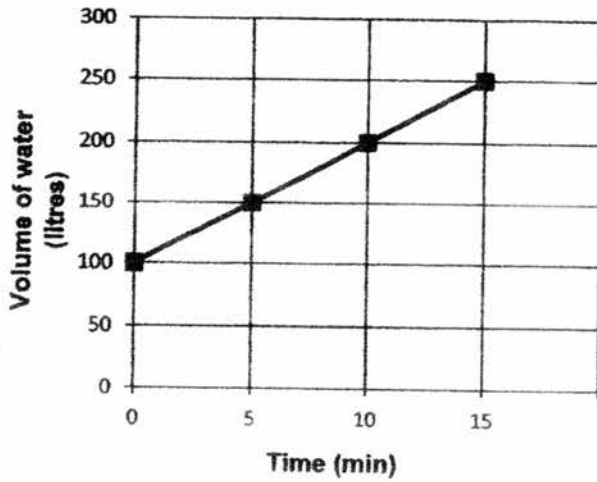

Do not write
in this
column

Ans: _____ [3]

- 9 Andy and Cal weigh 75 kg. Bain and Cal weigh 63 kg. Andy and Bain weigh 80 kg. What is the weight of the lightest boy?

Ans: _____ [3]

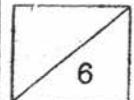

- 10 A factory produced red and blue toy cars. On the first day, 70 more blue toy cars were produced than red toy cars. On the second day, the number of blue toy cars produced was decreased by 10% and the number of red toy cars produced was increased by 30%. Given that 1273 blue and red toys cars were produced on the second day, how many blue toy cars was produced on the second day?

Do not write
in this
column

Ans : _____ [3]

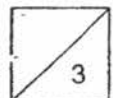

- 11 In a fishing competition, Janice caught 20 fish. There were only red and blue fish in the pond. 8 points were awarded for every red fish caught and 3 points were awarded for every blue fish caught. Janice was awarded 150 points. How many red fish did she catch?

Do not write
in this
column

Ans : _____ [4]

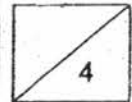

- 12 Mrs Wong bought a vacuum cleaner for \$336 after a 30% discount.
- a) What is the cost of the vacuum cleaner before discount?
 - b) She paid \$95 for an iron.
- The total discount for both the vacuum cleaner and the iron was \$174.
What percentage discount was given to the iron?

Do not write
in this
column

Ans: (a) _____ [1]

(b) _____ [3]

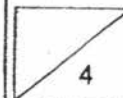

- 13 In the figure below, O is the centre of the circle and AO is parallel to DC .
Find $\angle g$.

Do not write
in this
column

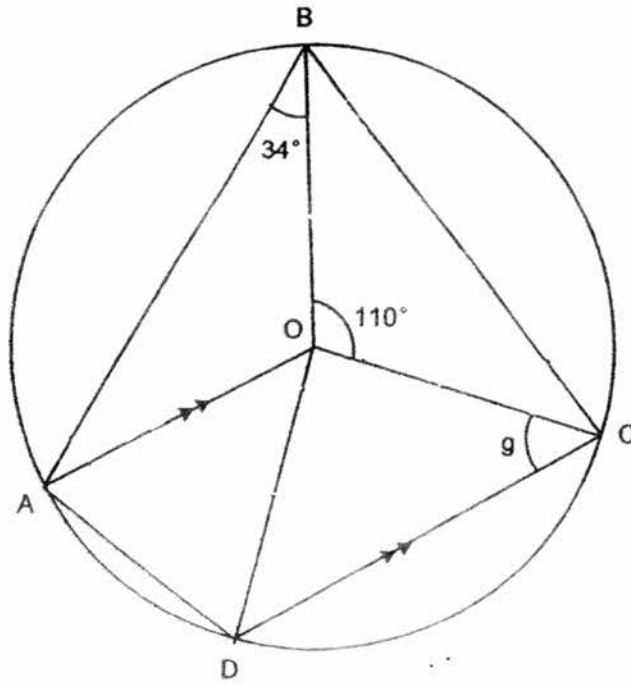

Ans: _____ [4]

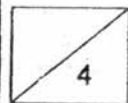

- 14 A farm produced 3150 more ^{duck} ~~chicken~~ eggs than ^{chicken} ~~duck~~ eggs. After selling $\frac{7}{12}$ of the chicken eggs and $\frac{7}{9}$ of the duck eggs, there was an equal number of chicken eggs and duck eggs left. How many eggs did the farm produce altogether?

Do not write
in this
column

Ans : _____ [4]

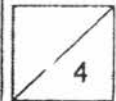

- 15 Square P and Rectangle Q overlap each other as shown in the figure below. The ratio of the area of Square P to its shaded area is 7 : 4. The area of Square P is $\frac{2}{3}$ of the area of Rectangle Q. Given that the total unshaded area of the figure is 57cm^2 , find the area of the whole figure.

Do not write
in this
column

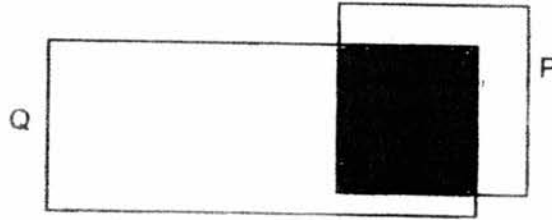

Ans : _____ [4]

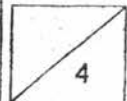

- 16 Tiffany had 60% as many sweets as Sue Ann. Tiffany gave away 20% of her sweets and Sue Ann bought another 46 sweets. Tiffany now has 25% as many sweets as Sue Ann. Find the number of sweets Tiffany had at first.

Do not write
in this
column

Ans : _____ [5]

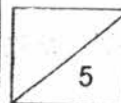

17

Mrs Tan bought some guavas at \$1.20 each and some mangoes at \$2 each. She spent \$2.40 less on the mangoes than on guavas. However, she bought 8 more guavas than mangoes.

- a) How many mangoes did she buy?
- b) How much did she spend on guavas?

Do not write
in this
column

Ans: (a) _____ [3]

(b) _____ [2]

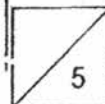

- 18 The figure is made up of a square of side 40 cm, a circle and identical semicircles. Find
- The area of the shaded figure.
 - The perimeter of the shaded figure.
- (Take $\pi = 3.14$)

Do not write
in this
column

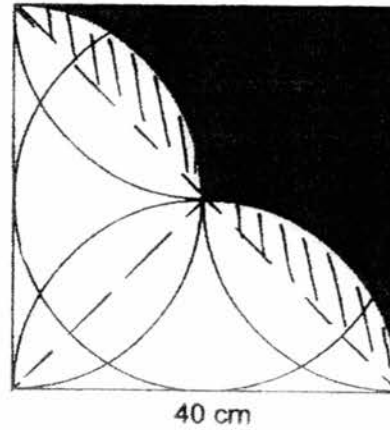

Ans: (a) _____ [3]

Ans: (b) _____ [2]

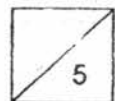

YEAR : 2016
 LEVEL : PRIMARY 6
 SCHOOL : SCGS
 SUBJECT : MATHEMATICS
 TERM : SA1

Paper 1
Booklet A

Q1	Q2	Q3	Q4	Q5	Q6	Q7	Q8	Q9	Q10
2	2	3	2	2	4	3	2	3	3
Q11	Q12	Q13	Q14	Q15					
3	4	3	1	4					

Booklet B

Q16 6.52

Q17 12

Q18 72

Q19

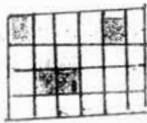

Q20 360%

$$Q21 \quad \frac{(9 \times 8) + 4}{4} = \frac{72 + 4}{4} = \frac{76}{4} = \underline{19}$$

$$Q22 \quad 3U \rightarrow 360^\circ - 90^\circ \times 2 = 180^\circ \Rightarrow \angle a \rightarrow \frac{180^\circ}{3} = \underline{60^\circ}$$

$$Q23 \quad 2.4 \text{ l} = 2400 \text{ ml. Time} \Rightarrow \frac{2400 \text{ ml}}{120 \text{ ml}} = \underline{20 \text{ min}}$$

$$Q24 \quad 18 \text{ cm} \times 10 \text{ cm} \times 9 \text{ cm} = \underline{1620 \text{ cm}^3}$$

Q25 16 : 9

$$Q26 \quad \$160 \times 6 = \underline{\$960}$$

Q27 3 big boxes

Q28 99 ym

Q29 $1u \rightarrow 45, 2u \rightarrow 45 \times 2 = 90 \Rightarrow \frac{90}{6} = \underline{15 \text{ bags}}$

Q30 $\frac{1}{2} \times \frac{8}{1} \times \frac{5}{1} = 20 \text{ cm}^2$

Paper 2

Q1 $3T + 6C = \$367.20, 1T \rightarrow 2u, 1C \rightarrow 1u, 3T + 6C \rightarrow 2u \times 3 + 1u \times 6 = 12u, 1u \rightarrow \frac{\$367.20}{12} = \$30.60 \Rightarrow \text{Table } (2u) \$30.60 \times 2 = \underline{\$61.20}$

Q2 $25u \rightarrow \text{suitcase}, 100u - 25u = 75u, \text{house loan} \rightarrow \frac{1}{2} \times 75u = 37.5u \text{ (left)}$
 $37.6u \rightarrow \$825, 1u \rightarrow \frac{\$825}{37.5} = \$22 \Rightarrow \text{salary} > \$22 \times 100 = \underline{\$2200}$

Q3 4

Q4 $96 - 30 = 66 \text{ coloured squares}$

Q5 $58 - 37 = \underline{21}$

Q6 $1u \rightarrow \frac{24}{8} = 3, 20u - 15u = 5u \Rightarrow 3 \times 5 = \underline{15}$

Q7 $\frac{1}{4} \text{ of } M + \frac{2}{5} \text{ of } W = 90$
 $\frac{3}{4} \text{ of } M + \frac{3}{5} \text{ of } W \rightarrow 300 - 90 = 210$
 $\frac{1}{4} \text{ of } M + \frac{1}{5} \text{ of } W \rightarrow 210 \div 3 = 70$
 $\frac{1}{5} \text{ of } W \rightarrow 90 - 70 = 20$
 $20 \times 5 = \underline{100}$

Q8 $100t = \frac{1}{8} \text{ of tank}$

Tank $\rightarrow 100t \times 8 = 800t$

$150t - 100t = 50t$

5 min $\rightarrow 50t$

1 min $\rightarrow 50t \div 5 = 10t$

Water more $800t - 250t = 550t \Rightarrow \text{Time } 550t \div 10t = \underline{55 \text{ min}}$

Q9 $80 \text{ kg} + 63 \text{ kg} + 75 \text{ kg} = 218 \text{ kg}$
 $218 \text{ kg} \div 2 = 109 \text{ kg}$
 Andy $\rightarrow 80 - 34 = 46 \text{ kg}$, Bain $\rightarrow 63 - 29 = 34 \text{ kg}$, Cal $\rightarrow 109 - 80 = \underline{29 \text{ kg}}$

Q10 $130u + 90u = 220u$
 $220u \rightarrow 1273 - 63 = 1210$
 $1u \rightarrow 1210 \div 220 = 5.5$
 $5.5 \times 90 + 63 = \underline{558 \text{ blue toy cars}}$

Q11 Total $\rightarrow 20 \times 3 = 60$
 Diff $\rightarrow 150 - 60 = 90$
 Individual diff $\rightarrow 8 - 3 = 5$
 Red fish $\Rightarrow \frac{90}{5} = \underline{18}$

Q12a Original price $\Rightarrow \frac{\$336}{70} \times 100 = \underline{\$480}$

Q12b Discount price, vacuum $\rightarrow \$480 - \$336 = \$144$
 Discounted price, iron $\rightarrow \$174 - \$144 = \$30$
 % discount, iron $\frac{\$30}{\$95 + \$30} \times 100\% = \underline{24\%}$

Q13 $\angle OCB \rightarrow (180^\circ - 110^\circ) \div 2 = 35^\circ$
 $\angle BOA \rightarrow 180^\circ - 34^\circ \times 2 = 112^\circ$
 $\angle AOC \rightarrow 360^\circ - 110^\circ - 112^\circ = 138^\circ$
 $\angle g \ 180^\circ - 138^\circ = \underline{42^\circ}$

Q14 Duck egg left $\rightarrow 1 - \frac{7}{9} = \frac{2}{9}$
 Chicken egg left $\rightarrow 1 - \frac{7}{12} = \frac{5}{12}$
 $\frac{2}{9}$ of D = $\frac{5}{12}$ of C $\rightarrow \frac{10}{45}$ of D = $\frac{10}{24}$ of C
 $45u - 24u = 21u \rightarrow 3150$
 $1u \rightarrow \frac{3150}{21} = 150$
 Total $150 \times (24 + 45) = \underline{10350 \text{ eggs}}$

Q15 Unshaded P $\rightarrow 14u - 8u = 6u$
 Unshaded Q $\rightarrow 21u - 8u = 13u$
 $13u + 6u = 19u \rightarrow 57 \text{ cm}^2$
 $1u \rightarrow 57 \text{ cm}^2 \div 19 = 3 \text{ cm}^2$
 Total area $\Rightarrow 3 \text{ cm}^2 \times (21 + 6) = 81 \text{ cm}^2$

Q16 Tiffany $48u$ or $25p$
Sue Ann $100u + 46$ or $100p$

$$100p \div 25p = 4$$

$$48u \times 4 = 100u + 46$$

$$192u = 100u + 46$$

$$92u \rightarrow 46$$

$$1u \rightarrow \frac{46}{92} = 0.5 \Rightarrow 0.5 \times 60 = \underline{30 \text{ sweets}}$$

Q17a

	<u>No.</u>	<u>X</u>	<u>Value</u>
Guavas	$1u + 8$	\$1.20	$1.2u + \$9.60$
Mangoes	$1u$	\$2	$2u$

$$2u + \$2.40 = 1.2u + \$9.60$$
$$2u = 1.2u + [\$9.60 - \$2.40 = (\$7.20)]$$
$$0.8u \rightarrow \$7.20 \Rightarrow 1u \rightarrow \frac{\$7.20}{0.8} = \underline{9 \text{ mangoes}}$$

Q17b $(9 + 8) \times \$1.20 = \underline{\$20.40}$

Q18a Semicircle $\rightarrow \frac{1}{2} \times 20 \text{ cm} \times 20 \text{ cm} \times 3.14 = 628 \text{ cm}^2$

Small triangle $\rightarrow \frac{40 \text{ cm} \times 40 \text{ cm}}{2} \div 2 = 400 \text{ cm}^2$

Two half leafs $\rightarrow 628 \text{ cm}^2 - 400 \text{ cm}^2 = 228 \text{ cm}^2$

$\frac{1}{2}$ of square $\rightarrow \frac{1}{2} \times 40 \text{ cm} \times 40 \text{ cm} = 800 \text{ cm}^2$

Shaded area $\rightarrow 800 \text{ cm}^2 - 228 \text{ cm}^2 = \underline{572 \text{ cm}^2}$

Q18b Semicircle arc $\rightarrow \frac{1}{2} \times 40 \text{ cm} \times 3.14 = 62.8 \text{ cm}$

Perimeter $\rightarrow 40 \text{ cm} \times 2 + 62.8 \text{ cm} = \underline{142.8 \text{ cm}}$