



2018 PRIMARY 5 SEMESTRAL EXAMINATION 2

Name : _____ ()

Date: 22 October 2018

Class : Primary 5 ()

Time: 8.00 a.m. - 9.45 a.m.

Parent's signature: _____

Duration: 1 hour 45 minutes

SCIENCE

BOOKLET A

INSTRUCTIONS TO CANDIDATES

1. Write your name, class and register number.
2. Do not turn over this page until you are told to do so.
3. Follow all instructions carefully.
4. Answer all questions.
5. Shade your answers on the Optical Answer Sheet (OAS) provided.

Booklet A (28 x 2 marks)

For each question from 1 to 28, four options are given. One of them is the correct answer. Make your choice (1, 2, 3 or 4) and shade your answer on the Optical Answer Sheet.

(56 marks)

1. Which of the following organisms reproduces by seeds?

(1) Fern

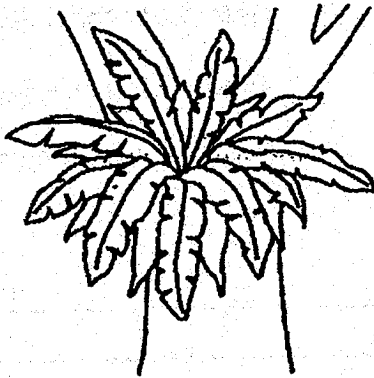

(2) Mushroom

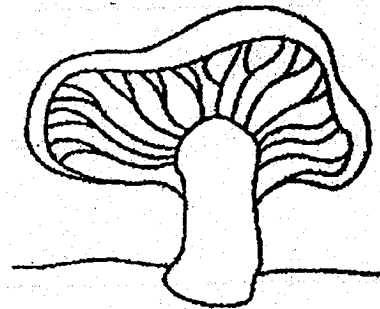

(3) Balsam plant

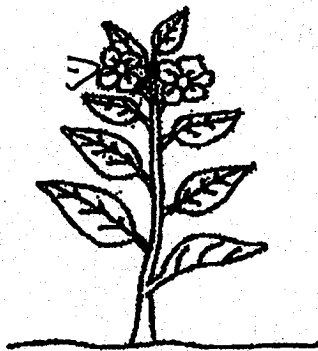

(4) Bread mould

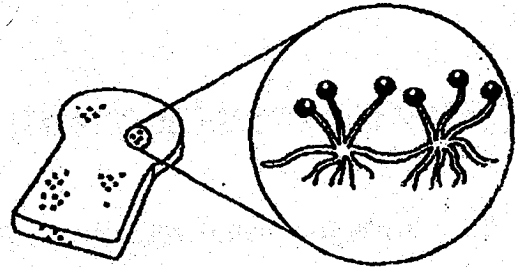

2. Which of the following is true about cells?

(1) All cells have a cell wall.

(2) All cells can be seen with the naked eye.

(3) Some living things are made up of one cell only.

(4) The leaf cell of a papaya plant has all the cell parts as its root cell.

3. The following shows the fruits of four plants.

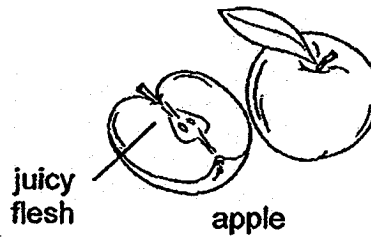
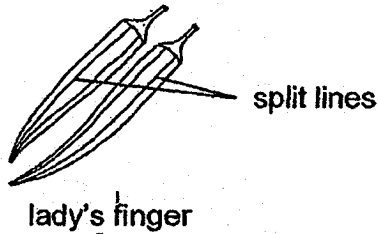
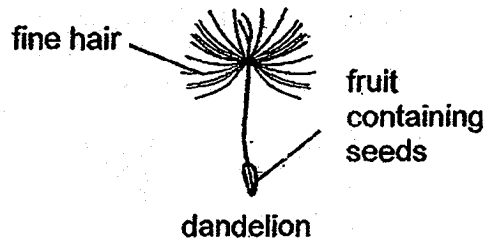
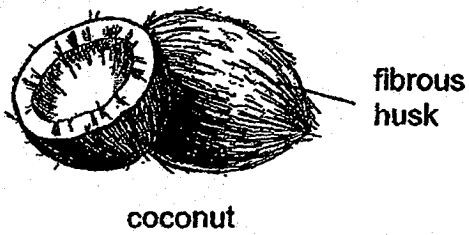

Study the flow chart below. P, Q, R and S represent the four fruits shown above.

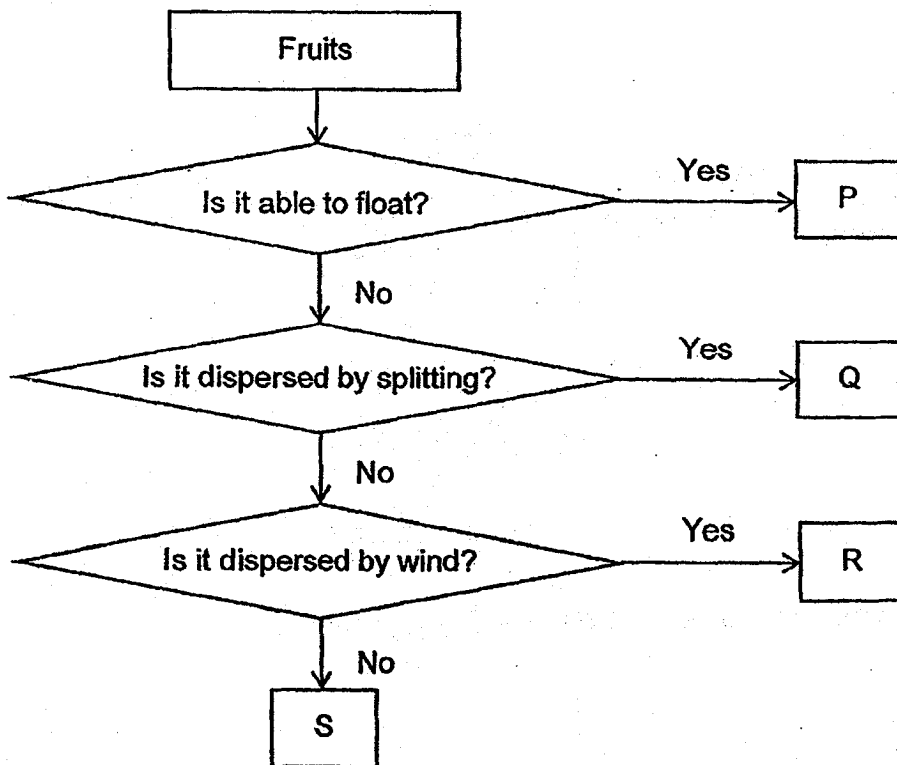

Which of the following is represented by P, Q, R and S?

	P	Q	R	S
(1)	coconut	apple	lady's finger	dandelion
(2)	dandelion	lady's finger	coconut	apple
(3)	apple	dandelion	coconut	lady's finger
(4)	coconut	lady's finger	dandelion	apple

4. Seeds were placed in three bottles X, Y and Z, in a well-lit room at room temperature as shown below.

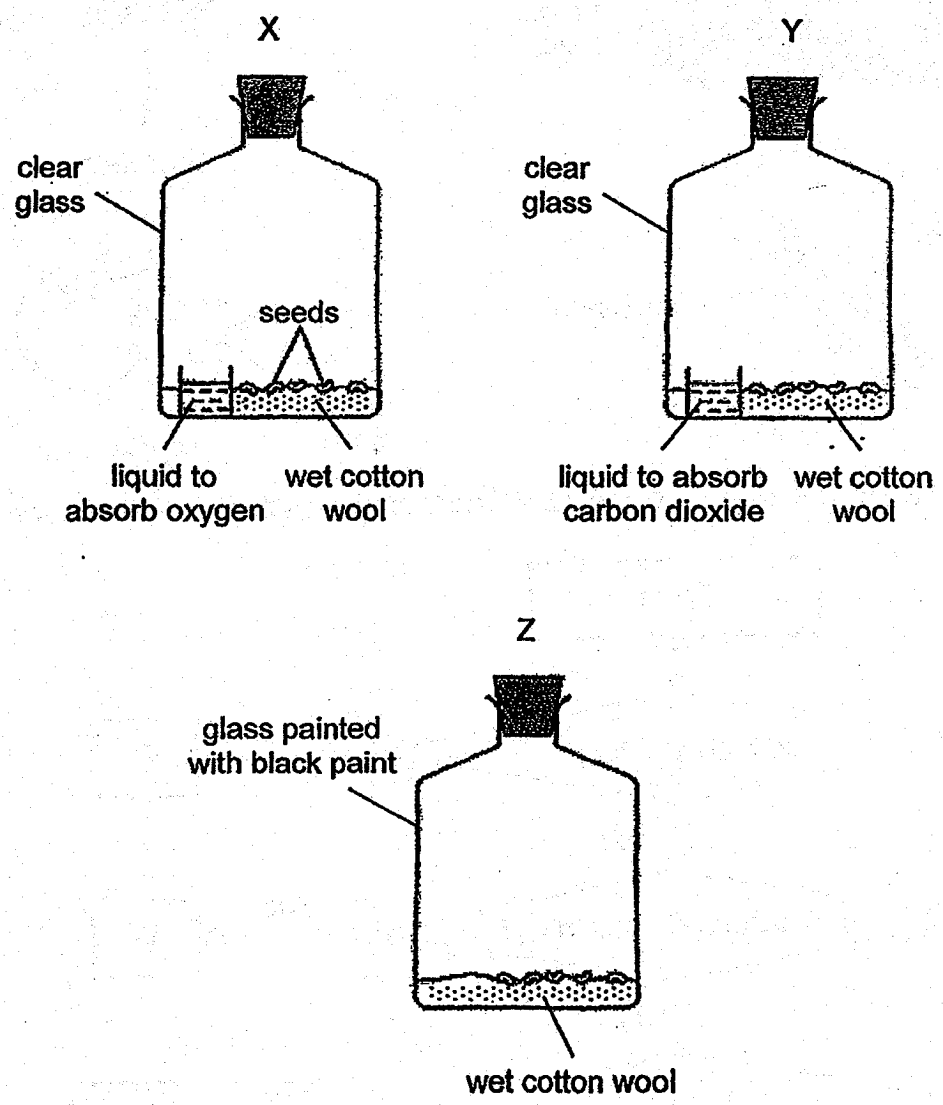

In which bottle(s) would the seeds most likely germinate?

- (1) X only
- (2) Y only
- (3) X and Z only
- (4) Y and Z only

5. The diagram below shows the female human reproductive system. Which part of the system releases eggs?

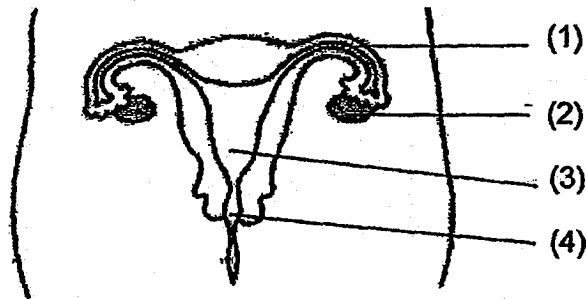

6. Gopal made three statements about sexual reproduction in plants and humans.

A: The fertilised egg develops in the womb.

B: The male reproductive cells are produced in the testes.

C: Characteristics are passed on from parents to their young.

Which of the above is correct in plants and/ or humans?

	Plants	Humans
(1)	C	A, B, C
(2)	C	A, B
(3)	A, C	B, C
(4)	A, B	C

7. Which of the following are transported by the blood in the human body?

A: oxygen

B: carbon dioxide

C: water

D: digested food

E: waste product

(1) B and E only

(2) A, C and D only

(3) A, B, D and E only

(4) A, B, C, D and E

8. The diagram below shows the direction of blood flow and the amounts of oxygen and carbon dioxide in some parts of the human body.

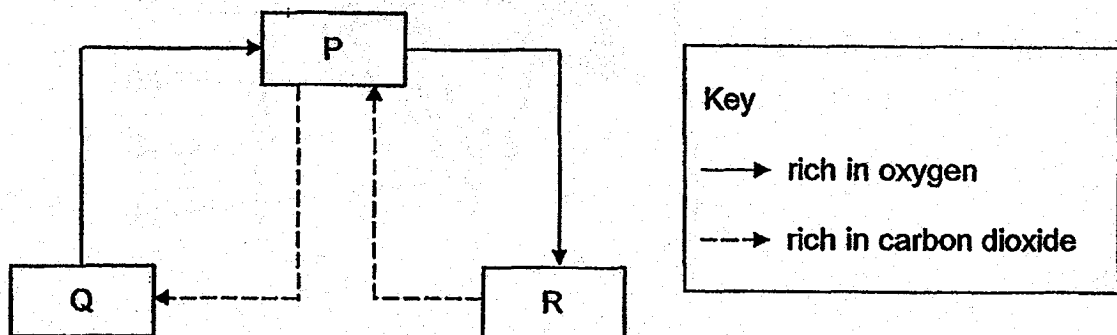

Which of the following are the body parts represented by P, Q and R?

	P	Q	R
(1)	heart	brain	lungs
(2)	lungs	heart	brain
(3)	heart	lungs	brain
(4)	brain	heart	lungs

9. Part X of two cells, A and B, is shown below.

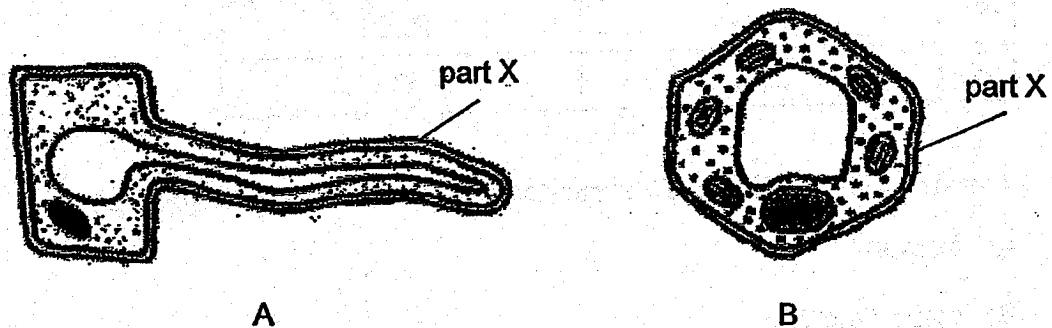

Which of the following is correct of the cells, A and B, and part X?

	Cell A	Cell B	Part X
(1)	animal cell	plant cell	cell membrane
(2)	plant cell	animal cell	cell wall
(3)	plant cell	plant cell	cell wall
(4)	plant cell	plant cell	cell membrane

10. In an experiment, David put a plant with two white flowers, X and Y, into a beaker containing blue-coloured water. After a few hours, flower X turned blue while flower Y remained white. He made three cuts, P, Q and R, as shown in the diagram below.

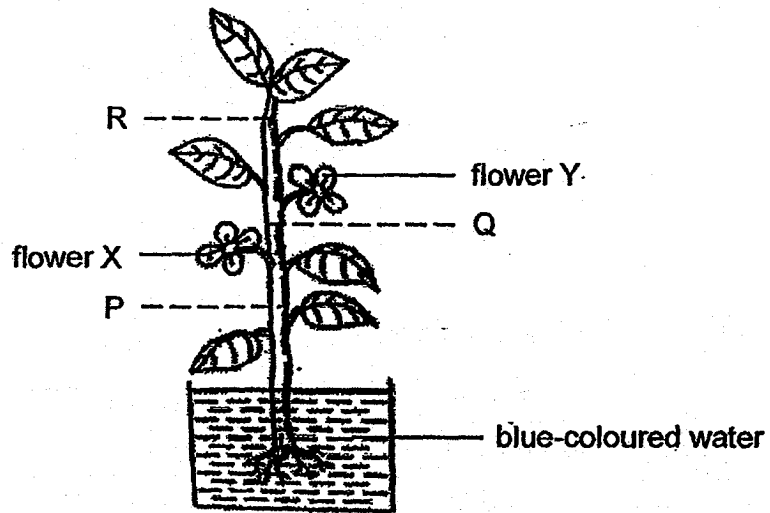

Which of the following diagrams show the cut-sections of the water-carrying tubes David would observe at P, Q and R?

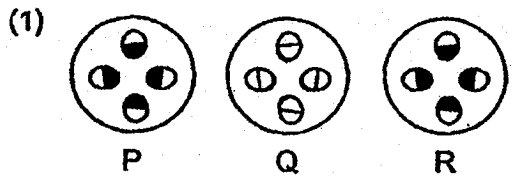

Key

⊖ without blue-coloured water

● with blue-coloured water

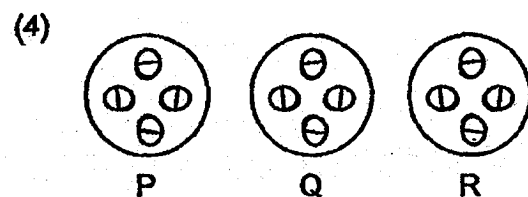
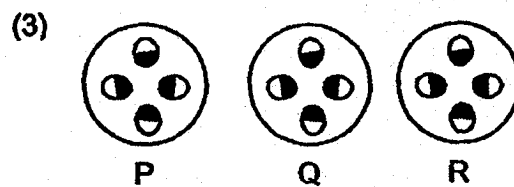
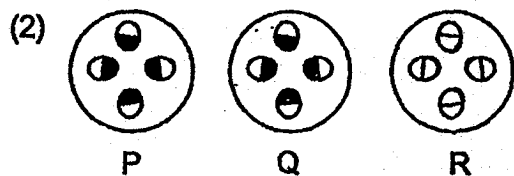

11. The diagram below shows the gaseous exchange of the leaves of a plant in a dark room.

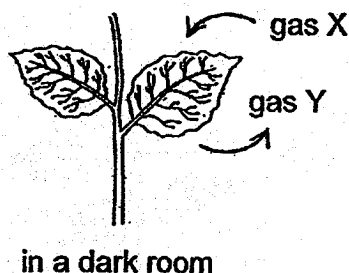

Which of the following represents gas X and gas Y?

	Gas X	Gas Y
(1)	carbon dioxide	oxygen
(2)	oxygen	carbon dioxide
(3)	water vapour	oxygen
(4)	oxygen	oxygen

12. Siti made a model of the human respiratory system with four main parts, A, B, C and D.

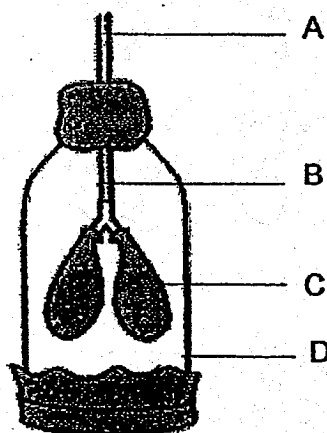

Which of the following correctly matches A, B, C or D to the correct part of the body and its function?

	Part	Function
(1)	A	nose where air leaves the body when we breathe in
(2)	B	windpipe transfers air from the nose to the lungs
(3)	C	ribcage protects the lungs
(4)	D	lung where oxygen is absorbed from the air into the blood

13. Which of the following does not affect the amount of food absorbed after a meal?
- (1) length of gullet
 - (2) length of small intestine
 - (3) amount of digestive juice in the stomach
 - (4) number of times a person chews his food before swallowing

14. Yati conducted an experiment to find out whether carbon dioxide is needed for photosynthesis. She used the set-up below.

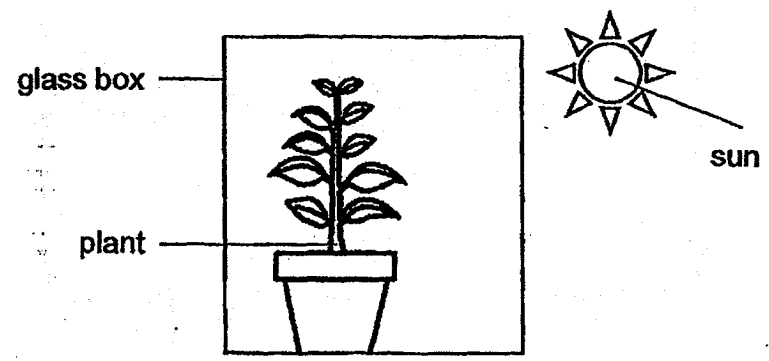

Which of the following should Yati use as a control for her experiment?

- (1) (2) (3) (4)
- (1) glass box
substance to remove carbon dioxide.
- (2) black box
water
- (3) glass box
substance to remove oxygen
- (4) black box
substance to remove carbon dioxide

15. The diagram shows an electric circuit.

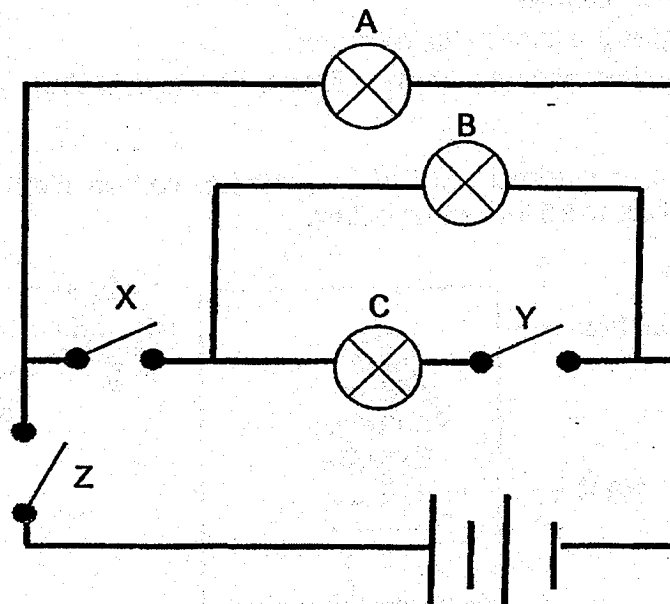

In which order must the switches be closed so that Bulb A lights up first, follow by Bulb B and then Bulb C?

	1 st switch to close	2 nd switch to close	3 rd switch to close
(1)	X	Z	Y
(2)	Y	Z	X
(3)	Z	Y	X
(4)	Z	X	Y

16. The diagram below shows an electromagnet and a toy car.

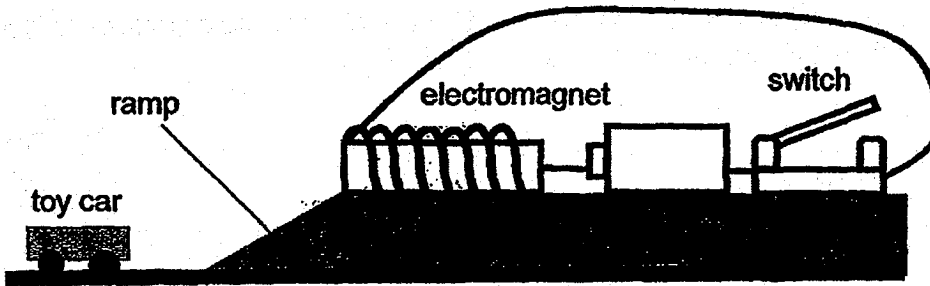

When the switch is closed, the toy car moves up the ramp towards the electromagnet.

Based on the above information, which of the following statement(s) is/ are true?

- A: The toy car is made of magnetic material.
- B: As the number of batteries increases, the toy car will move up the ramp faster.
- C: As the number of coils around the electromagnet decreases, the toy car will move up the ramp faster.

- (1) A and B only
- (2) B and C only
- (3) A and C only
- (4) A, B and C

17. Which of the following pictures shows that water is being conserved?

(1)



Using a hose to wash a car

(2)

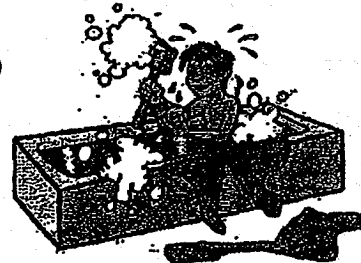

Bathing in a bath tub

(3)



Watering a plant with water that has been used to wash rice grains

(4)

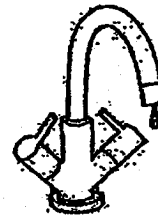

Leaking tap

18. Doreen set up an experiment as shown. 100 ml of water was poured on each of the four shirts which are made of different materials.

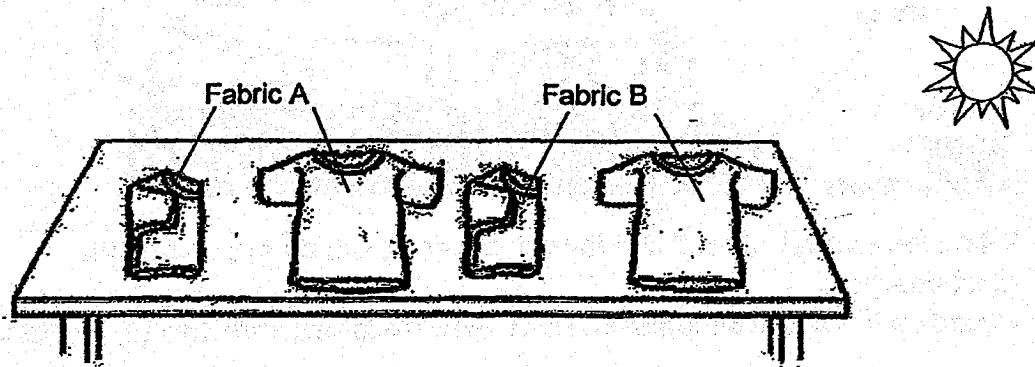

All the shirts were placed under the Sun and Doreen measured the amount of time taken for each shirt to be completely dry.

Which are the possible aims of the experiment?

- A: To find out if type of fabric affects the rate of evaporation.
- B: To find out if the amount of water affects the rate of evaporation.
- C: To find out if the exposed surface area of the fabric affects the rate of evaporation.

- (1) C only
- (2) A and B only
- (3) A and C only
- (4) A, B and C

19. The diagram below shows the changes of the state of water.

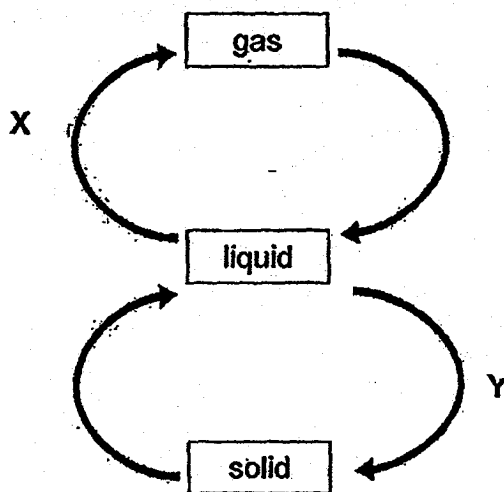

What are processes X and Y?

	X	Y
(1)	condensation	freezing
(2)	boiling	melting
(3)	evaporation	freezing
(4)	evaporation	melting

20. The diagram below shows a circuit tester and a circuit card.

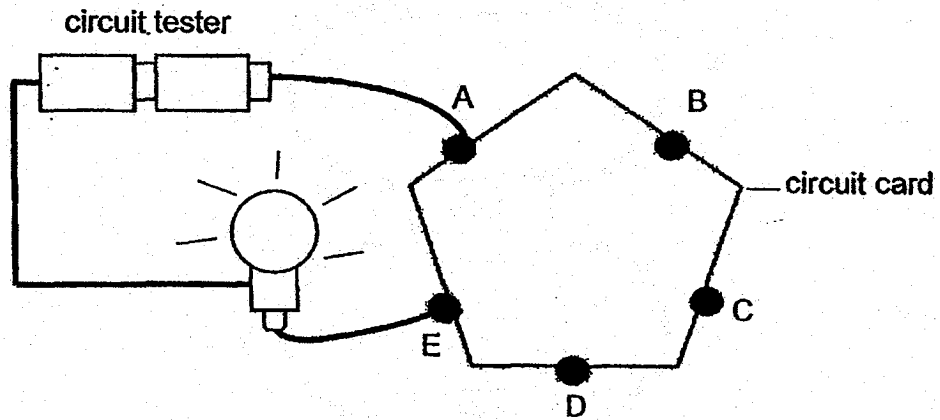

The bulb lights up when the circuit tester is connected to the points, A and E, of the circuit card as shown above.

Which of the following diagrams, W, X, Y or Z, show(s) the possible connection of the wires of the circuit card?

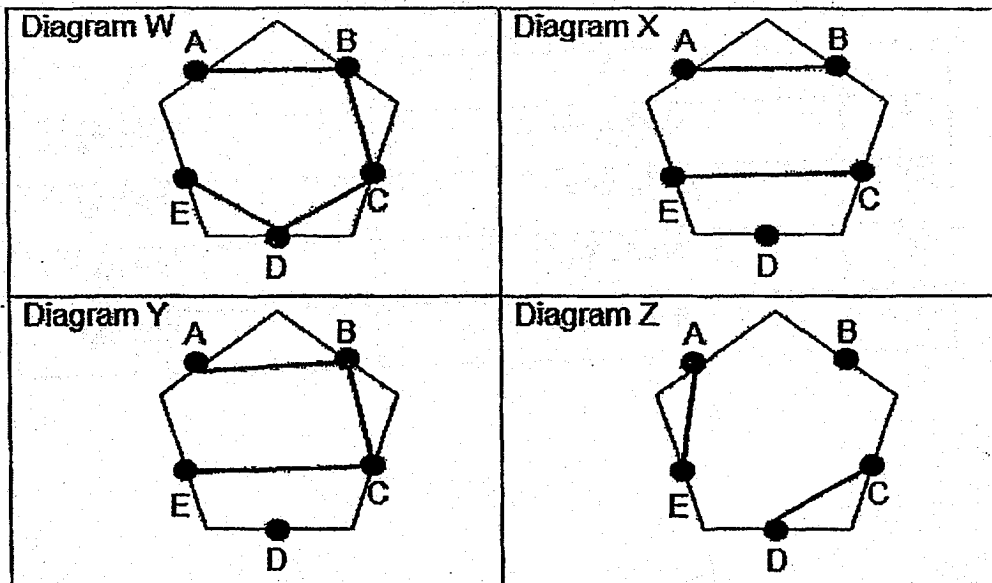

- (1) Z only
- (2) Y and Z only
- (3) W, X and Y only
- (4) W, Y and Z only

21. The diagram shows a circuit with three identical bulbs, X, Y and Z.

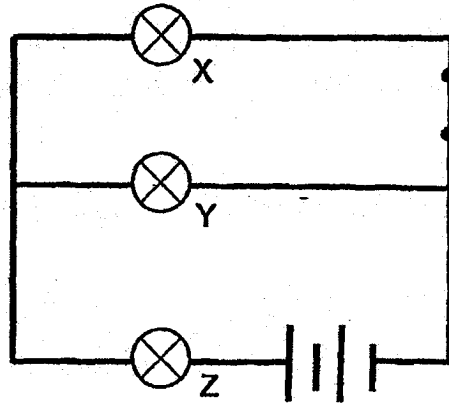

Which of the following is correct?

- (1) The switch control bulbs, X and Z.
 - (2) There are four batteries in the circuit.
 - (3) Bulbs X, Y and Z are arranged in series.
 - (4) When bulb X fuses, bulb Y and Z will remain lit.
22. The picture below shows the effect of light shining on a puppet.

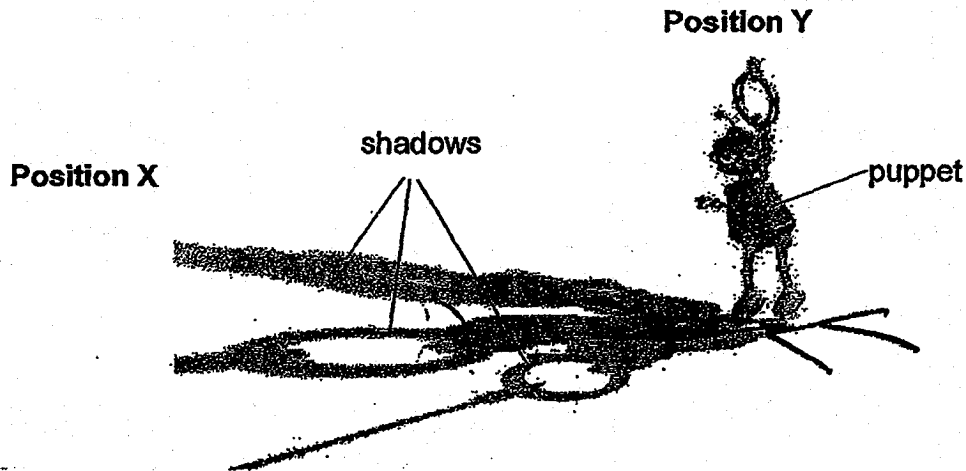









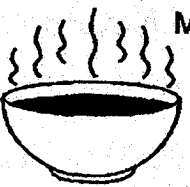

Based on the picture above, which of the following statements is correct?

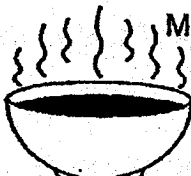
- (1) The light source is at Position X.
- (2) The light source is at Position Y.
- (3) The puppet allows all light to pass through.
- (4) There are more than one light source shining on the puppet.

23. Laura conducted an experiment using three similar bowls of soup, all at the same temperature of 30°C . She placed the bowls in rooms with different surrounding temperatures.

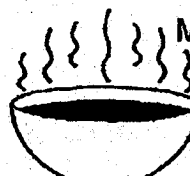
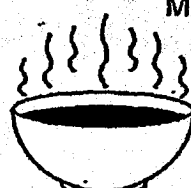
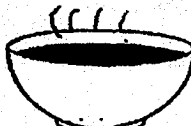
Which of the following correctly shows "white mist" being present?

	Surrounding temperature at 0°C	Surrounding temperature at 30°C	Surrounding temperature at 60°C
(1)	 Mist	 Mist	 Mist
(2)		 Mist	 Mist
(3)			 Mist
(4)	 Mist		

24. Sasha put same number of hot pizzas inside two boxes made of different materials as shown below.

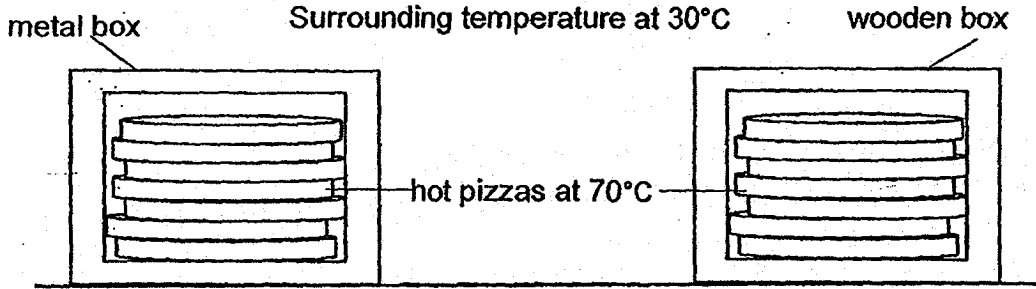

Based on the above, which of the following graphs represents the temperature change of the hot pizzas in the two boxes over a few hours?

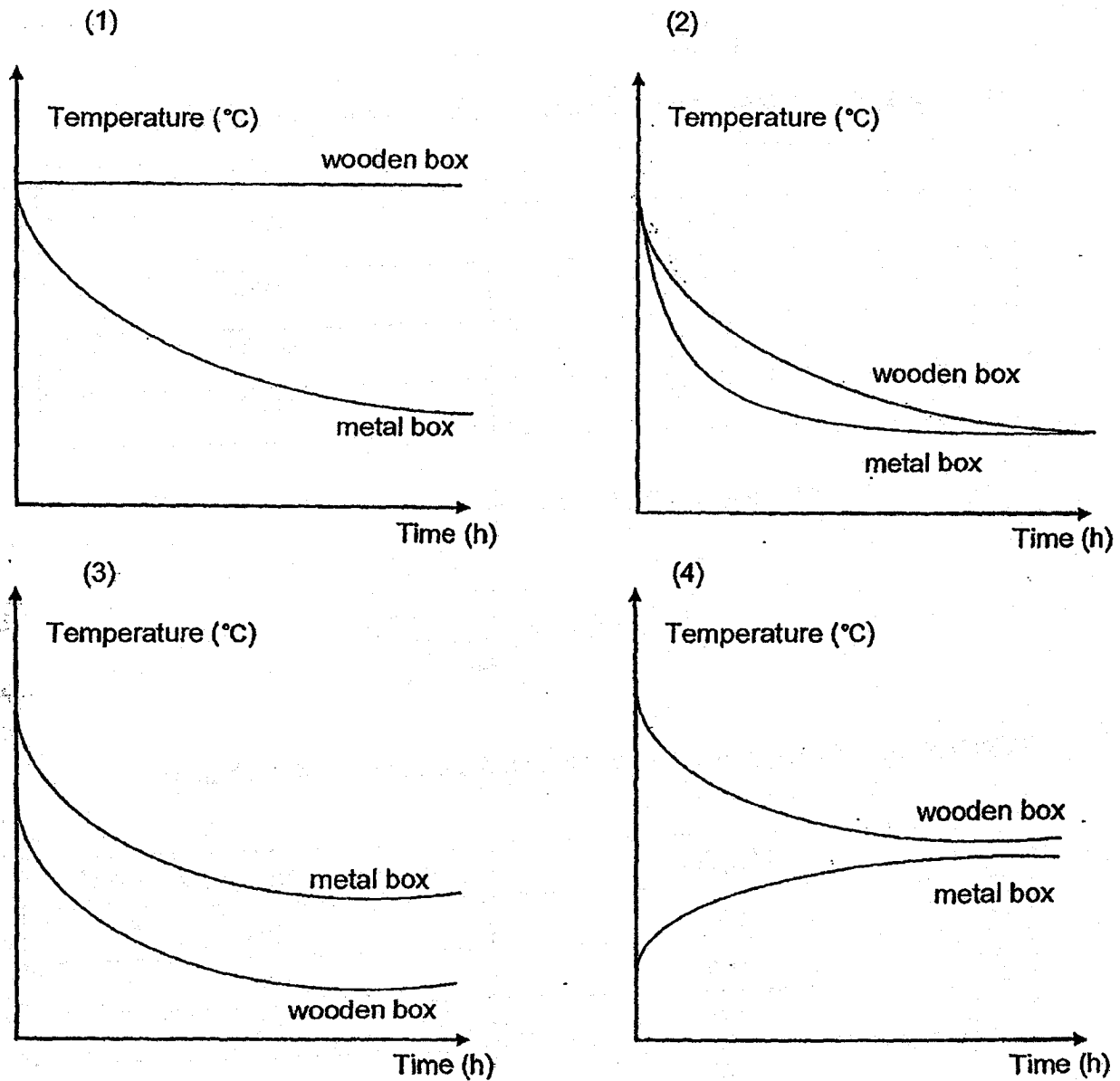

25. A compass has a small magnet that can rotate freely as shown.

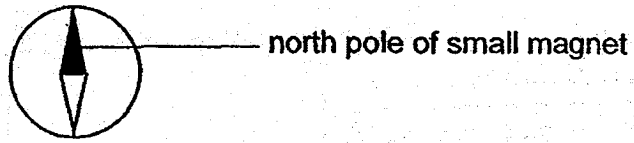

Magnets A and B are attracted as shown below.

The compass shows its direction when it is placed near X of Magnet A.

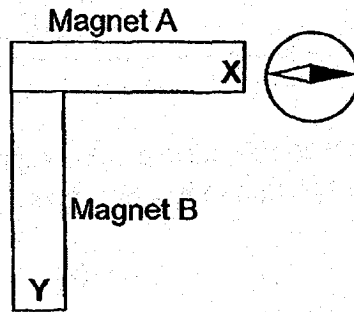

Which one of the following correctly represents the poles, X and Y?

	X	Y
(1)	north	south
(2)	south	north
(3)	south	south
(4)	north	north

26. A frying pan used for cooking is shown below.

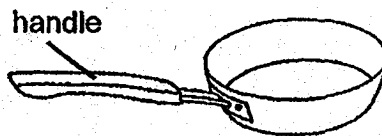

Which of the following most correctly states the properties of the handle?

	Flexible	Freezing point below 100°C
(1)	yes	yes
(2)	yes	no
(3)	no	yes
(4)	no	no

27. A circuit diagram is shown below.

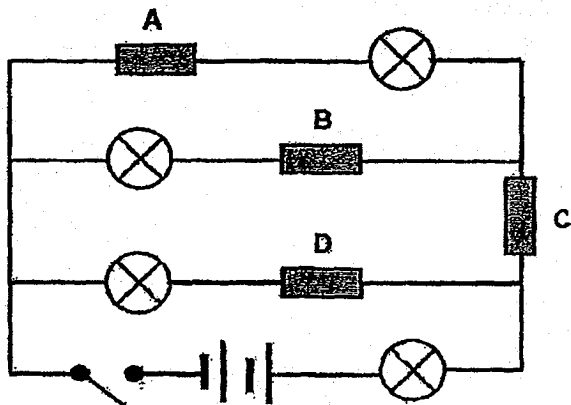

There are four blocks, A, B, C and D. Only one of the four blocks is an insulator of electricity.

When the switch is closed, only two bulbs light up.
Which of the blocks is the insulator of electricity?

- (1) A
- (2) B
- (3) C
- (4) D

28. Jack used the following set-ups to find out more about the objects, E and F. First, he placed both objects on the balance as shown below.

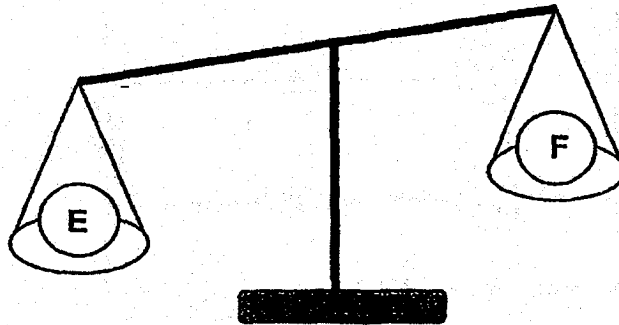

Then he placed both objects into two similar beakers containing 100 ml of water as shown below.

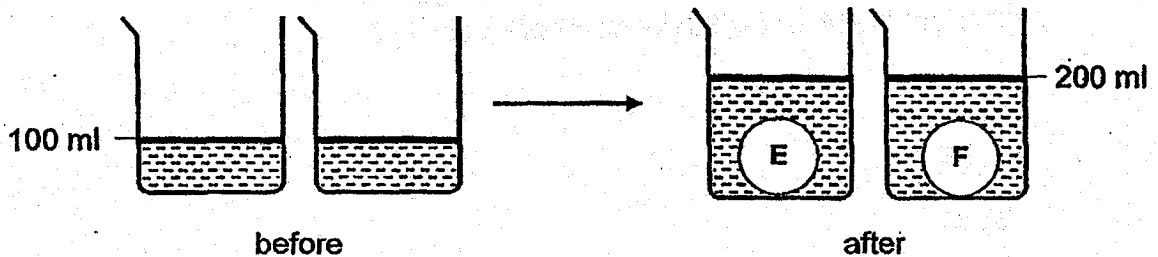

Based on Jack's observations of the above set-ups, what conclusions can he make about the objects, E and F?

- (1) Objects E and F are not matter.
- (2) Objects E and F has similar mass.
- (3) Object E has smaller mass than Object F.
- (4) Objects E and F occupy the same amount of space.

End of Booklet A



2018 PRIMARY 5 SEMESTRAL EXAMINATION 2

Name : _____ ()

Date: 22 October 2018

Class : Primary 5 ()

Time: 8.00 a.m. – 9.45 a.m.

Parent's Signature : _____

Duration: 1 hour 45 minutes

SCIENCE

BOOKLET B

INSTRUCTIONS TO CANDIDATES

1. Write your name, class and register number.
2. Do not turn over this page until you are told to do so.
3. Follow all instructions carefully.
4. Answer all questions.
5. Write your answers in the booklet.

Booklet A	56
Booklet B	44
Total	100

Booklet B (44 marks)

For questions 29 to 40, write your answers clearly in this booklet.

The number of marks available is shown in brackets [] at the end of each question or part question.

(44 marks)

29. The graph below shows the mass of a butterfly during the four different stages of its life cycle. D is the adult stage.

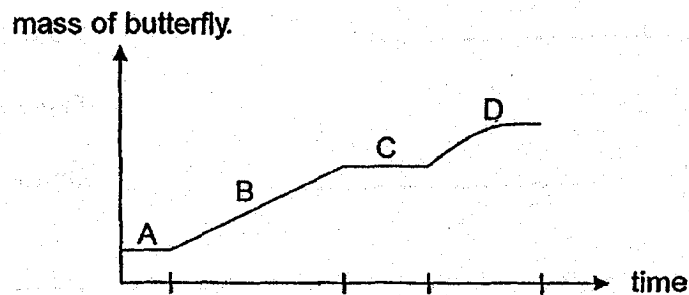

- (a) Name stage C in the life cycle of the butterfly.

[1]

- (b) Suggest a reason why the mass of the butterfly at stage B has the greatest increase.

[1]

- (c) Name an insect that has the same number of stages in its life cycle as that of a butterfly.

[1]

Score	3
-------	---

30. The diagram below shows how a fruit is formed from the flower of a plant in Location A. The fruit has been cut open.

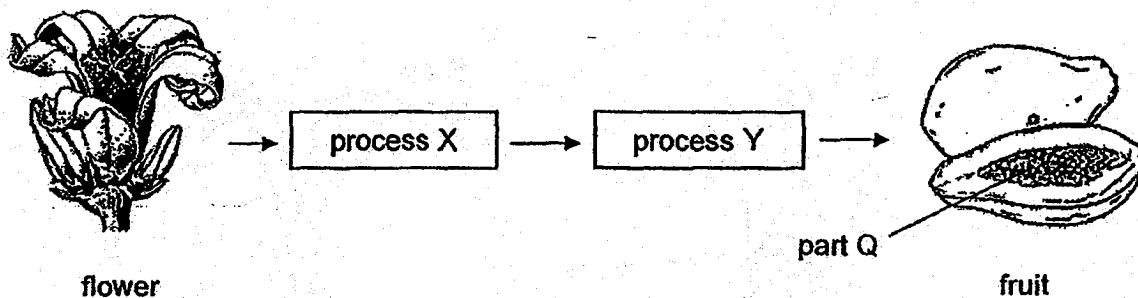

- (a) Name process X. [1]

- (b) State the part of the flower that part Q developed from. [1]

- (c) The fruit is fleshy and it contains seeds that are hard and stone-like. Describe how the seeds can be dispersed by a monkey to another far away location, B. [1]

- (d) How does dispersal of seeds help the young plant? [1]

31. The diagrams below show the reproductive parts of a flowering plant (Diagram 1) and a human (Diagram 2).

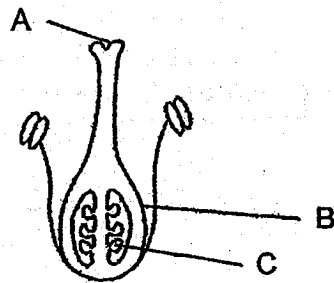

Diagram 1

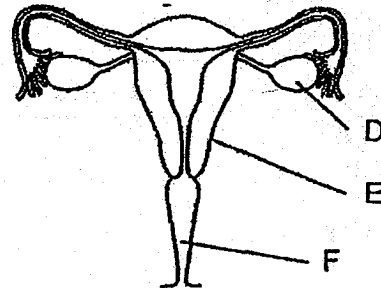

Diagram 2

- (a) Write the letters, A, B, C, D, E or F, that represent the ovary in Diagram 1 and Diagram 2 in the table below. [1]

Diagram 1	Diagram 2
ovary: _____	ovary: _____

The diagram below shows sperms swimming towards an egg cell.

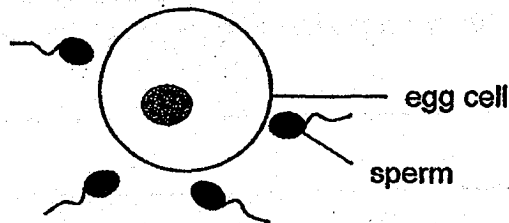
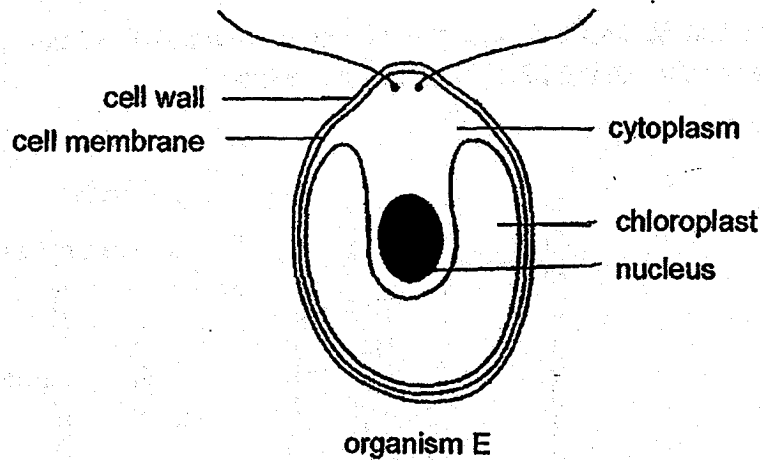

Diagram 3

- (b) Describe the process that will happen in Diagram 3. [1]

- (c) After the process you have described in (b), describe what happens to the egg cell as it moves to part E of Diagram 2. [1]

32. The diagram below shows a single-celled organism which lives in a pond.



(a) Which part(s) of organism E enables it to function like a plant cell? [1]

(b) State the function of the chloroplast. [1]

(c) The diagram below shows organism F.

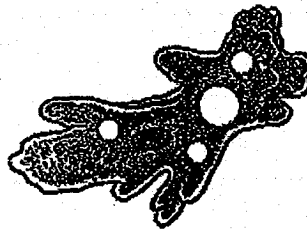

organism F

Based on the diagram, give a reason why organism F can be classified as an animal cell. [1]

Score	3
-------	---

33. Sophie wanted to find out how the distance between the lamp and the water plant affects the number of bubbles produced by the plant.

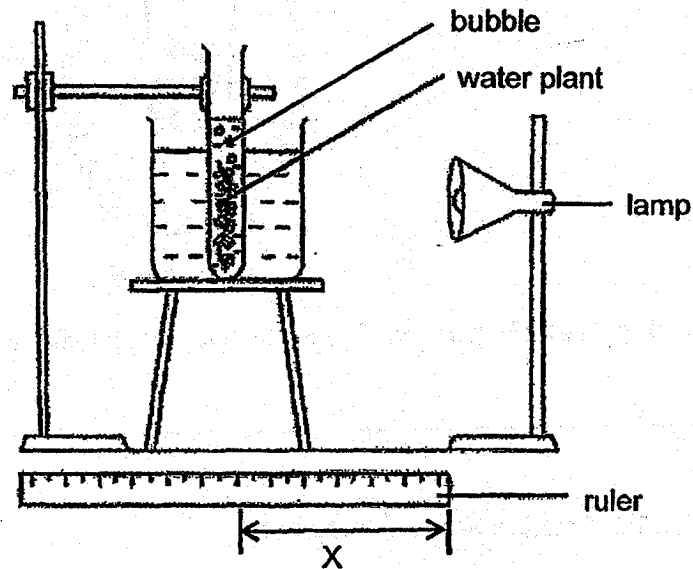

She switched on the lamp and set its brightness at 100 units. She counted the number of bubbles produced per minute for different distances, X.

- (a) Complete the table below which shows the number of bubbles produced per minute with different distances X. [1]

Distance X (cm)	Number of bubbles produced per minute
50	200
100	
150	100

- (b) What can she conclude on the relationship between the number of bubbles produced per minute and distance X? [1]

(c) Diagram A below shows a tree in an open field during the day time.

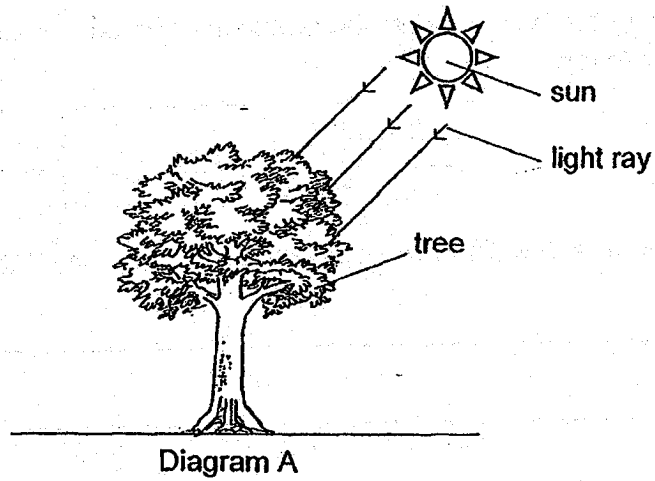

After a while, a thick cloud appeared above the tree as shown in Diagram B.

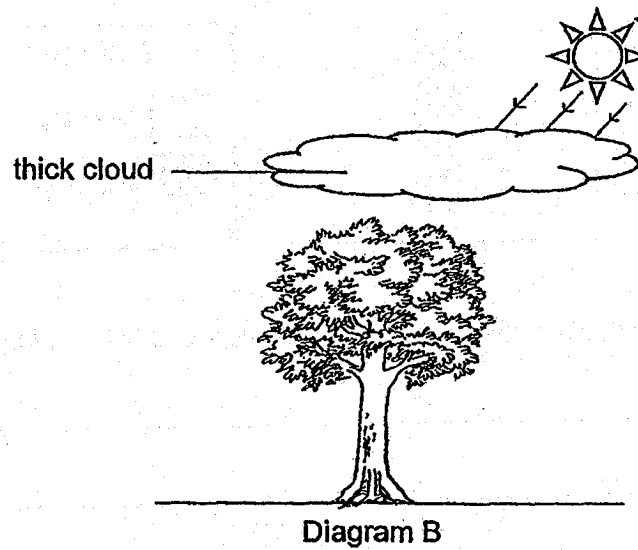

Explain how the rate of photosynthesis is affected in Diagram B when a thick cloud is above the tree. [2]

Score	2
-------	---

34. The diagram below shows the direction of blood flow in the blood vessels, X and Y, in Samuel's legs.



- (a) Compare the difference between the amount of oxygen at X and at Y. [1]

Samuel carried out an experiment to measure the volume of blood supplied per minute to the legs during two activities, walking and running.

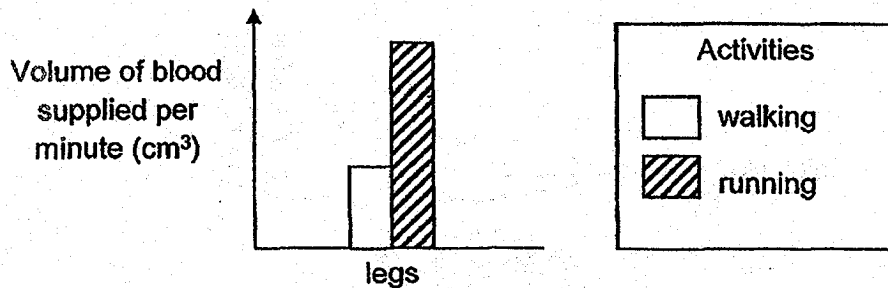

- (b) Describe how oxygen in the surroundings reaches Samuel's legs. [2]

- (c) Based on the graph above, explain how running affects the amount of oxygen supplied to the legs. [2]

35. Kumar heated some ice cubes in a beaker. After some time, he removed the candle and left the beaker to cool in the same room.

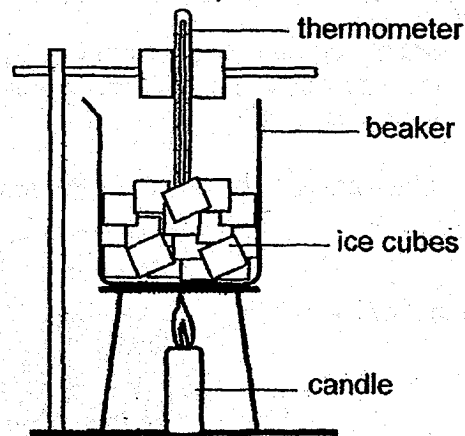

Based on his observations, he plotted a graph as shown below.

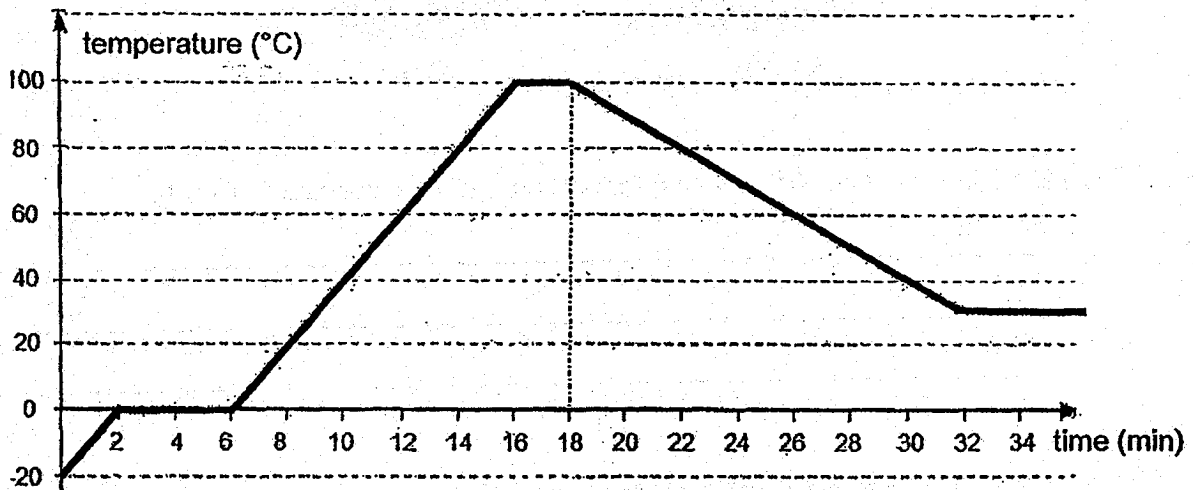

- (a) Based on the graph above, how long does the melting process take? [1]

- (b) The maximum temperature recorded is 100°C at the 16th minute.

Why did the temperature remain constant at 100°C from 16th to 18th minute even though Kumar continued to heat the beaker? [1]

- (c) What do you think Kumar did to his set-up after 18th minute? [1]

36. Mary poured same amount of tap water into Cup A and Cup B and added 200 cm^3 of ice into each cup. The ice in Cup A is in smaller cubes while the ice in Cup B is in a single big block.

The diagrams below show the results of the experiment after two minutes.

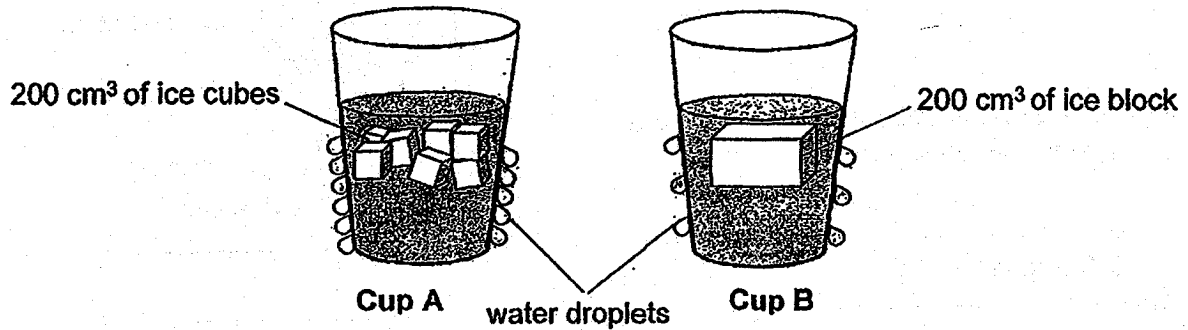

- (a) Explain how water droplets are formed on the outer surface of Cup A. [2]

- (b) From the observations above, Mary concluded that the water in Cup A is colder than the water in Cup B after two minutes.

Describe what she had observed in the above diagrams to make her conclusion.

[1]

- (c) Explain why the water in Cup A will be colder than water in Cup B after two minutes.

[2]

Score	5
-------	---

37. Ming Han set up the circuit shown below. He observed that bulbs, P, Q and R, lit up while the electric bell buzzed.

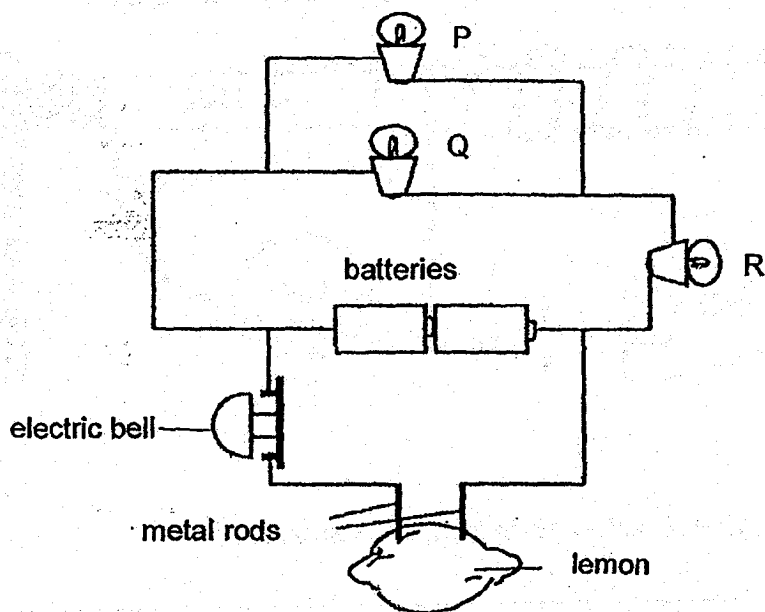

- (a) Based on the above, state one property of the lemon. [1]
-

- (b) Ming Han wants to turn off the bell without turning off any of the bulbs. Mark a cross (X) on the part of the wire in the above electric circuit to indicate where you would place the switch to turn off the bell without turning off any of the bulbs. [1]

- (c) Which of the bulbs (if any) would remain lit if bulb Q fused? [1]
-

38. The diagram below shows an electric circuit of a simple doorbell.

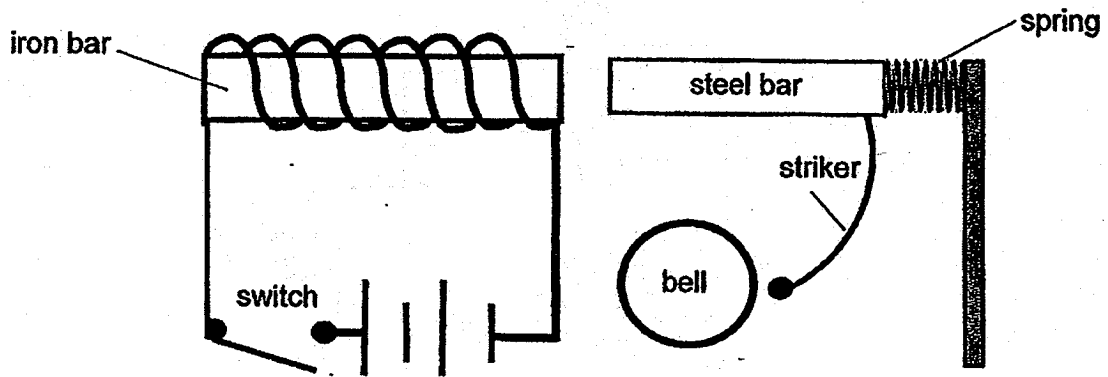

(a) Describe what will happen when the switch is closed.

[2]

(b) The metal bar is now replaced with a wooden block. Will the doorbell still work? Explain.

[1]

Score	3
-------	---

The diagram below shows a set-up that uses four identical lamps to heat food. When the lamps are brighter, they give out more heat.

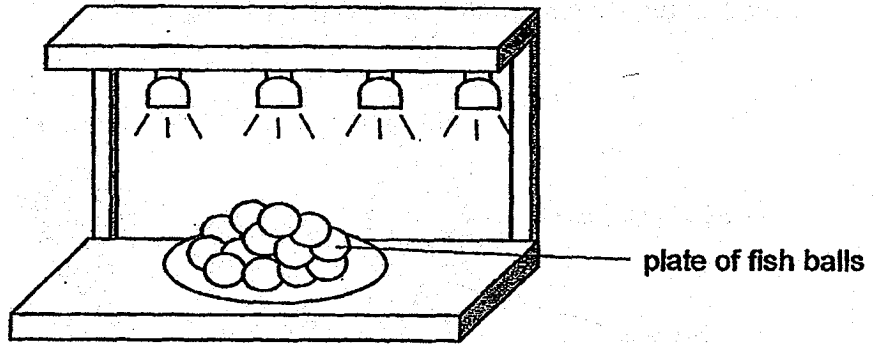

An engineer has prepared two circuits as shown below.

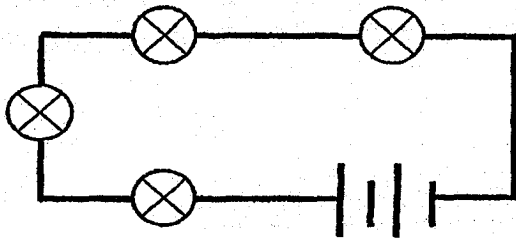

circuit A

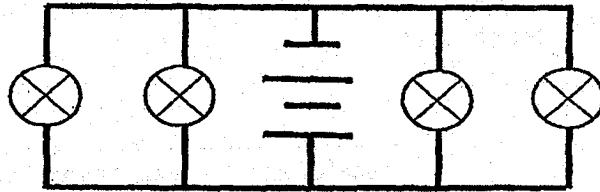

circuit B

(c) Which circuit, A or B, will be able to keep the fish balls warmer?
Explain your answer.

[1]

Score	1
-------	---

39. Xiao Ming wants to find out whether air or water is a better conductor of heat. He sets up an experiment as shown below using similar balloons, P and Q. The balloon, P, is filled with air while the balloon, Q, is filled with water.

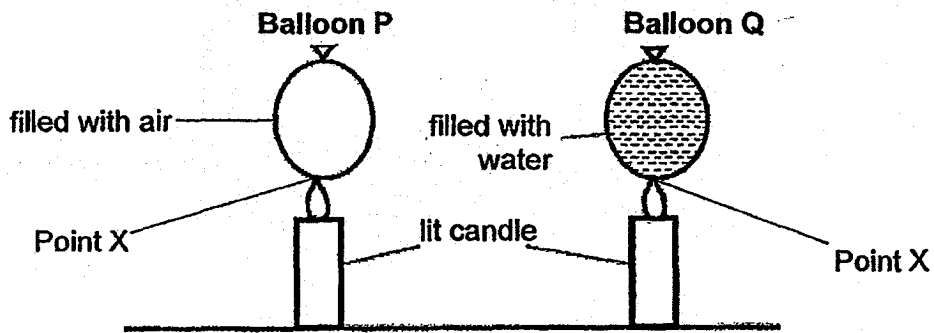

Xiao Ming placed both balloons over a candle flame at Point X and recorded the time taken for each balloon to burst. The balloon burst when the rubber has gained too much heat.

Balloon	Time taken for balloon to burst (sec)
P	3
Q	100

- (a) From the above results, does air or water conduct heat faster away from the balloon?

Explain why.

[1]

Xiao Ming took a cold thick-walled glass from a refrigerator. He poured boiling water into the glass and placed it into a basin of boiling water.

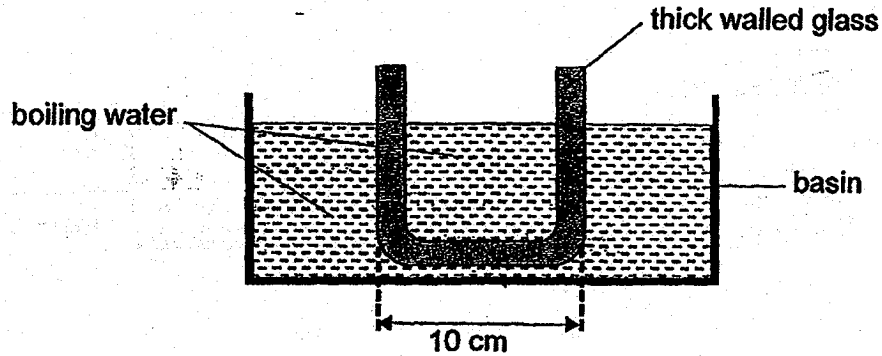

He observed that the width of the base of the glass changed from 10 cm to 11.5 cm.

(b) Explain what had happened to the glass. [1]

Xiao Ming now took a cold thick-walled glass from a refrigerator and poured boiling water into it and left it on a table at room temperature as shown below.

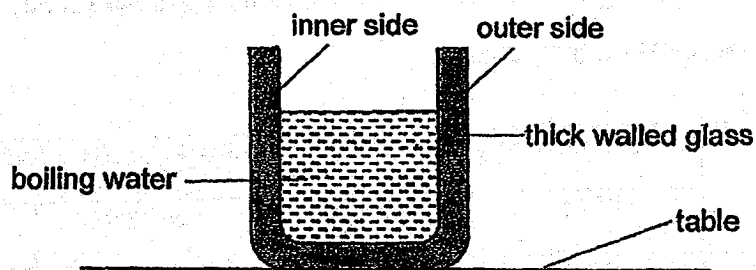

He observed that the glass cracked.

(c) Explain the above observation. [2]

40. Susan moved a paper clip towards a magnet slowly until the paper clip was attracted to the magnet as shown below.

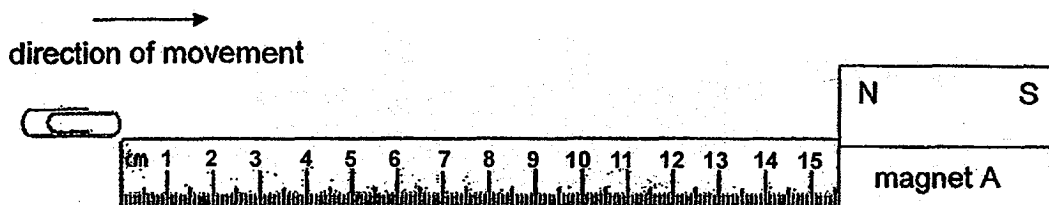

She measured the furthest distance at which the paper clip was just attracted to the magnet.

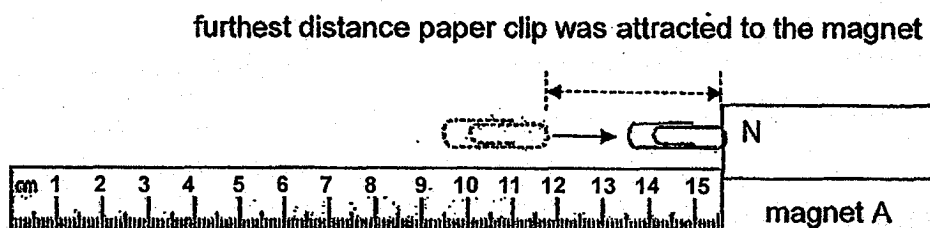

She repeated the experiment to get two more readings with magnets, B and C.

The table below shows her results.

	Distance(cm) at which paper clip was attracted to magnet			
	1 st try	2 nd try	3 rd try	Average
Magnet A	10.0	9.9	10.1	10.0
Magnet B	6.2	5.9	5.9	6.0
Magnet C	3.2	0.4	3.3	2.3

(a) Susan's teacher told her that the results for one of the magnets is not reliable. Identify the magnet and give a reason why you selected the magnet. [1]

(b) Based on the table above, which magnet has the strongest magnetic pull? Explain why. [1]

(c) How would the distance at which the paper clip was attracted to magnet A be affected if a heavier paper clip was used? [1]

Score	3
-------	---

End of Paper

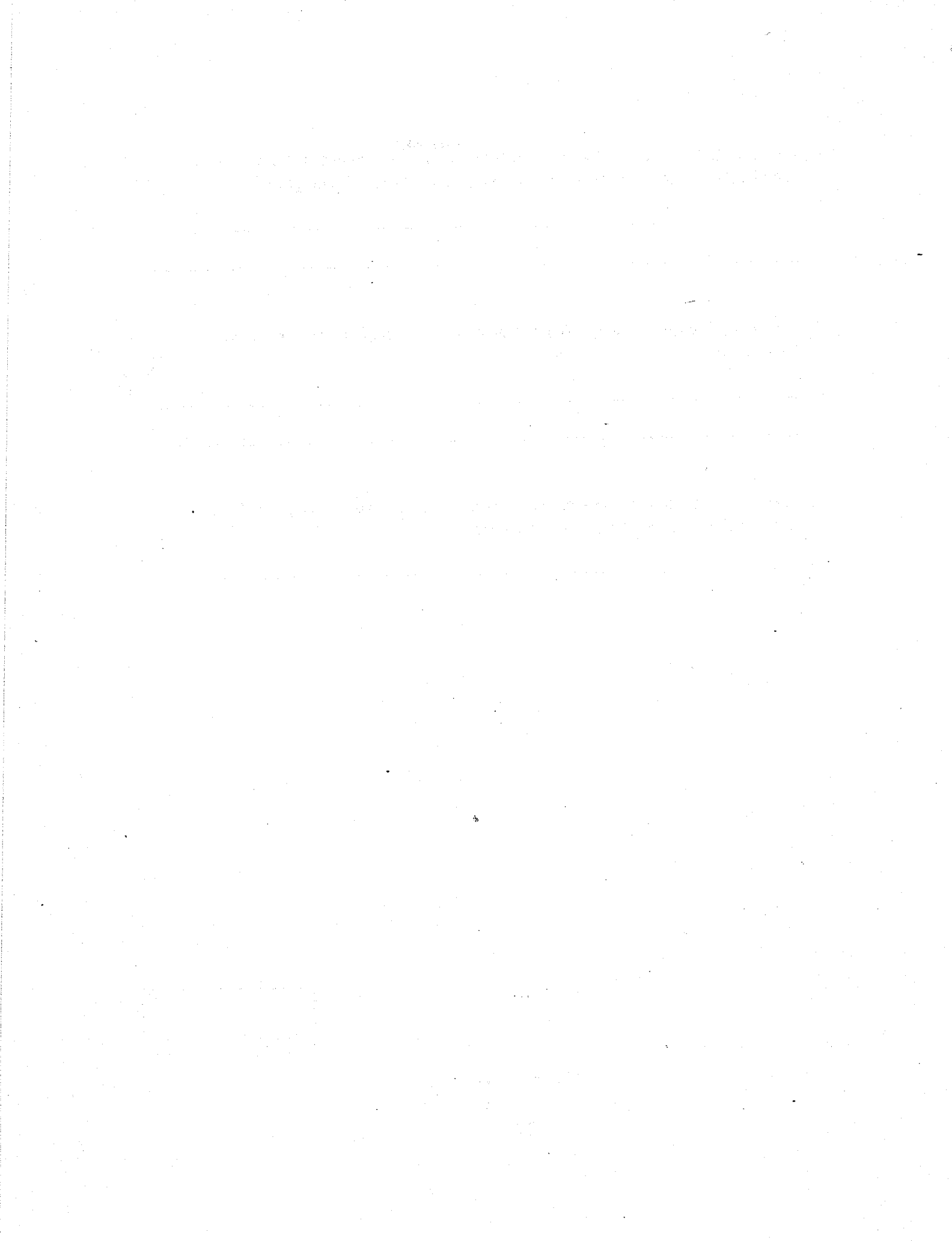

SCHOOL : TAO NAN PRIMARY SCHOOL
LEVEL : PRIMARY 5
SUBJECT : SCIENCE
TERM : 2018 SA2

SECTION A

Q 1	Q2	Q3	Q4	Q5	Q6	Q7	Q8	Q9	Q10
3	3	4	4	2	1	4	3	3	2
Q 11	Q12	Q13	Q14	Q15	Q16	Q17	Q18	Q19	Q20
2	2	1	1	4	1	3	3	3	4
Q 21	Q22	Q23	Q24	Q25	Q26	Q27	Q28		
4	4	4	2	1	4	3	4		

SECTION B

Q29)	<p>a)Pupa</p> <p>b)The butterfly at stage B needs to eat a lot so that it will not die of starvation when it is at the pupa stage.</p> <p>c)Mosquito.</p>
Q30)	<p>a)Pollination.</p> <p>b)Ovules.</p> <p>c)As the seeds are indigestible, the seeds will end up in the Monkey's waste. When the monkey discharge its waste, somewhere else the seed is dispersed away from its parents.</p> <p>d)It helps the young plant by dispersing it far away from its parents so there will be a lower chance of overcrowding.</p>
Q31)	<p>a)Diagram 1 : B Diagram 2: D</p> <p>b)The sperm cell will fertilise the egg.</p> <p>c)The fertilised egg develops into a foetus.</p>

Q32)	<p>a)Cell wall and chloroplast.</p> <p>b)To allow the plant to trap light to photosynthesis so that is can make food by itself.</p> <p>c)It does not have a regular shape.</p>
Q33)	<p>a)150</p> <p>b)As distance X increases, the number of bubbles produced per minute decreases.</p> <p>c)As there was a cloud above the tree, sunlight form the sun could not through. As a result light could not be trapped and the tree could not photosynthesis.</p>
Q34)	<p>a)The amount of oxygen at X is more than the amount of oxygen at Y.</p> <p>b)The nose take in the oxygen in the surrounding and the oxygen goes through the windpipe and reaches the lungs. The oxygen is then absorbed into the blood stream and is brought to the legs when the heart pumps the blood there.</p> <p>c)When Samuel run's the amount of oxygen supplies to his legs increases as his legs needs more oxygen to produce energy so that he can run.</p>
Q35)	<p>a)4 min</p> <p>b)All the heat was used on turning the water into water vapour.</p> <p>c)He removed the candle and left the beaker to cool.</p>
Q36)	<p>a)Water vapour from surrounding touches the cooler Glass A and condenses.</p> <p>b)The amount of water droplets on the outside surface of cup A is more then the amount of water droplets on the outside surface of cup B.</p> <p>c)As the surface area of the ice cubes in A is cause larger than the ice is B to the water the rate of heat loss will be faster, so ice will gain heat from the water.</p>

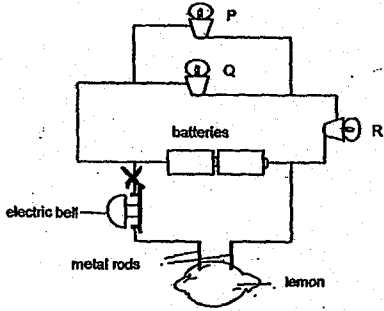
<p>Q37)</p>	<p>a) It is an electrical conductor.</p> <p>b)</p>  <p>c) P and R.</p>
<p>Q38)</p>	<p>a) The circuit will become closed, making the iron bar an electro magnet. When the iron bar becomes an electro magnet, the steel bar is attracted, when it moves toward, the striker hits the bell.</p> <p>b) No, it won't. The wooden block is made out of a non-magnetic material thus when the switch is closed, the wooden bar won't become an electro magnet and cannot attract the wooden block and cannot cause the striker to hit the bell and make it ring.</p> <p>c) Circuit B. The bulbs are arranged in parallel, more electricity flows through each bulb so that each bulb in B is brighter than each bulb in A.</p>
<p>Q39)</p>	<p>a) Water conductor heat faster away from the balloon as balloon Q took a longer time to burst.</p> <p>b) The glass gained heat and expanded.</p> <p>c) The inner side of the glass gains more heat than the outer side. The uneven expansion caused the glass to crack.</p>
<p>Q40)</p>	<p>a) Magnet C. The difference between 2nd reading and the rest of the readings are very big.</p> <p>b) Magnet A. It managed to attract the paper clip from the longest distance amount the 3 magnets.</p> <p>c) The distance at which the paper clip was attracted to the magnet will decrease.</p>

--	--