



CATHOLIC HIGH SCHOOL
SEMESTRAL ASSESSMENT ONE (2018)
PRIMARY FIVE
SCIENCE
BOOKLET A

Name: _____ ()

Class: Primary 5 - _____

Date: 11 May 2018

28 questions

56 marks

Total Time for Booklets A and B: 1 hour 45 minutes

INSTRUCTIONS TO CANDIDATES

Do not turn over this page until you are told to do so.

Follow all instructions carefully.

Answer all questions.

Shade your answers in the Optical Answer Sheet (OAS) provided.

This booklet consists of 19 printed pages, excluding the cover page.

Booklet A (28 × 2 marks)

For each question from 1 to 28, four options are given. One of them is the correct answer. Make your choice (1, 2, 3 or 4). Shade your answer on the Optical Answer Sheet. (56 marks)

- 1 Dean prepared four set-ups, A, B, C and D. At the start of the experiment, he added 200 ml of water to each of the set-ups.

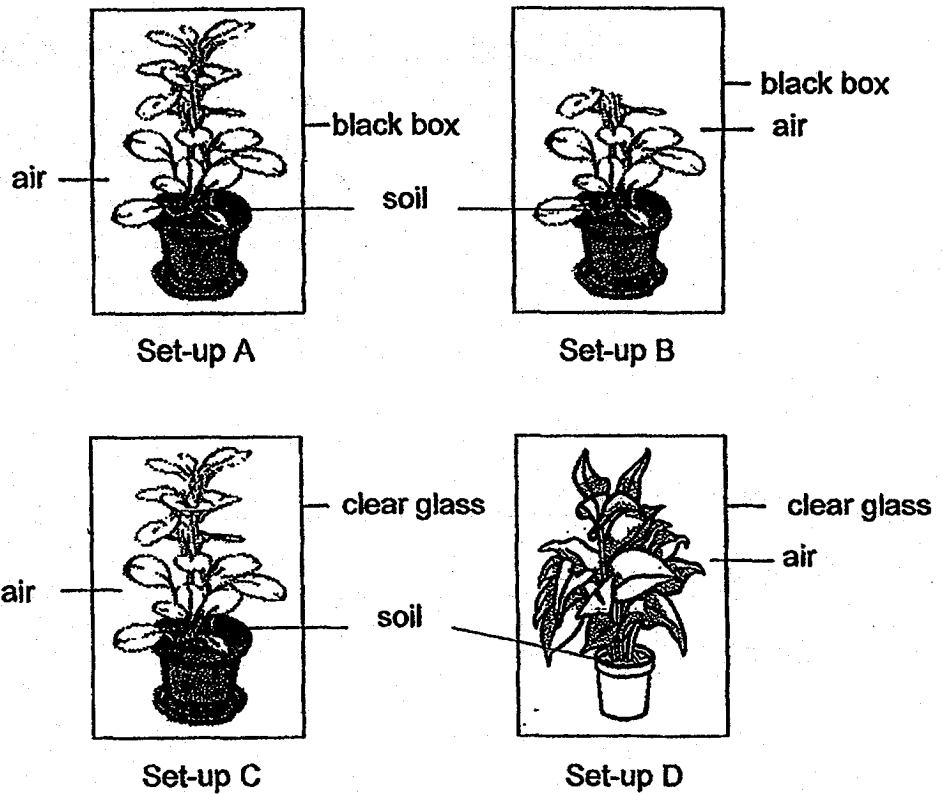

Which two set-ups should be used to find out if sunlight is needed for plants to grow?

- (1) A and B
- (2) A and C
- (3) B and D
- (4) C and D

2 Four pupils made the following statements about the characteristics of yeast.

Tim Yeast is microscopic.

Muthu Yeast and bacteria are fungi.

Wendy Yeast only needs water and air to grow.

Joe Yeast and bacteria belong to the same animal group.

Which pupil(s) is/are correct?

(1) Tim only

(2) Muthu and Joe only

(3) Joe and Wendy only

(4) Muthu and Wendy only

3 The diagram below shows the human digestive system.

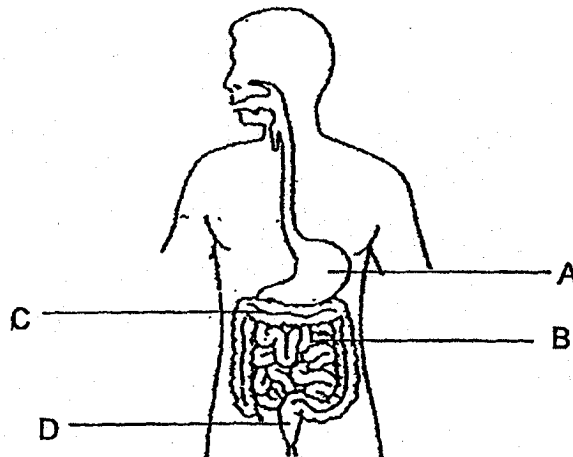

Which part of the human digestive system, A, B, C or D, absorbs water and mineral salts from undigested food?

(1) A

(2) B

(3) C

(4) D

4 Which of the following functions cannot be performed if the roots of a plant are damaged?

- A absorbing sunlight
- B taking in water and mineral salts
- C holding the plant firmly to the ground

- (1) C only
- (2) A and B only
- (3) B and C only
- (4) A, B and C

5 Jenny observed three animals, A, B and C. She drew a table and placed a tick (✓) in the box when she made the observations. The completed table is as follows.

Observation	Animal		
	A	B	C
4 stages in the life cycle	✓		
Gives birth to young alive		✓	
Young resembles the adult		✓	✓
Moults several times at one stage of its life cycle	✓		✓

Which one of the following correctly represents animals A, B and C?

	A	B	C
(1)	cockroach	elephant	butterfly
(2)	cockroach	butterfly	elephant
(3)	butterfly	cockroach	elephant
(4)	butterfly	elephant	cockroach

6 Study the diagram below.



Which one of the following statements is correct about the male part of a flower?

- (1) It is made up of only the stigma.
- (2) It is made up of only the filament.
- (3) It is made up of the stigma and style.
- (4) It is made up of the anther and the filament.

7 The statements below describe the different stages of sexual reproduction in flowering plants.

- A The seed develops.
- B The anther releases pollen grains.
- C Pollen grains are transferred to the stigma.
- D The male sex cell moves along the pollen tube towards the ovary.
- E The male sex cell fuses with the female sex cell.

Which of the following shows the correct order of the stages?

- (1) A → B → D → C → E
- (2) B → C → D → E → A
- (3) B → D → A → E → C
- (4) C → B → D → A → E

- 8 Study the diagram below.



What is the dispersal method for the fruit above?

- (1) by wind
 - (2) by water
 - (3) by animals
 - (4) by explosive action
- 9 Joey conducted an experiment to find out if the presence of water would affect seed germination. She prepared the set-ups as shown below.

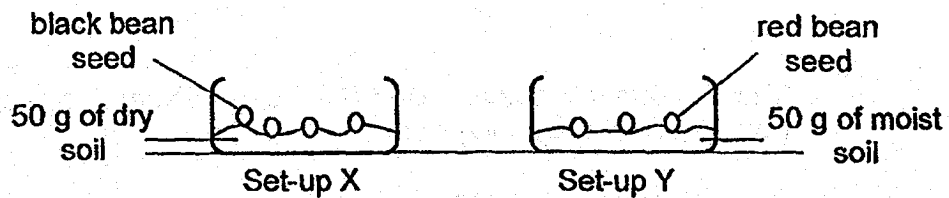

Her classmates commented that her experimental set-ups were incorrect. Which of the following should she do to ensure a fair test?

- A Add one more seed to set-up Y.
- B Add water to the *dry soil* in set-up X.
- C Reduce the amount of *dry soil* in set-up X.
- D Replace the black bean seed in set-up X with red bean seeds.

- (1) A and B only
- (2) A and D only
- (3) B and C only
- (4) C and D only

- 10 Minah carried out an experiment on the germination of seeds using two containers, A and B, as shown below.

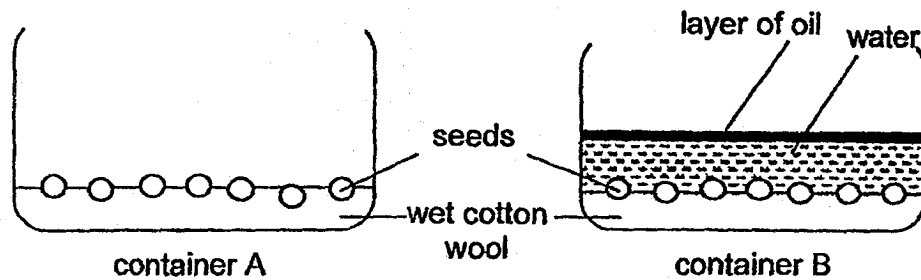

After three days, the seeds in container A germinated but the seeds in container B did not. Based on this experiment, which one of the following caused the seeds in container A to germinate but not the seeds in container B?

- (1) air
- (2) light
- (3) water
- (4) temperature

- 11 Study the diagrams below.

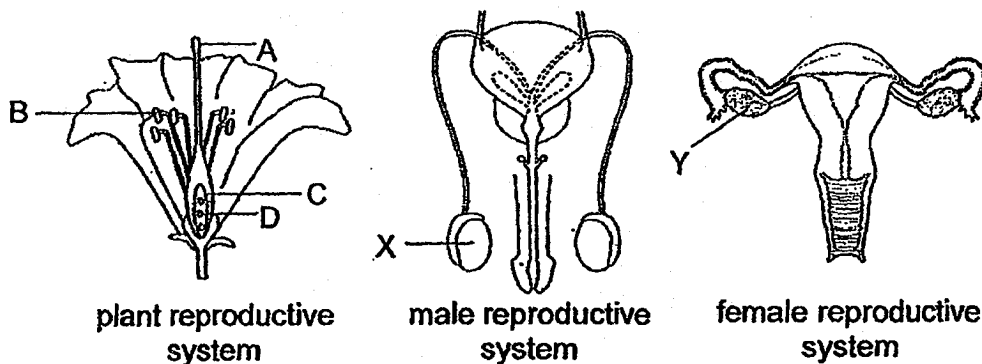

Which of the following represents the parts of the flower which have the same functions as parts X and Y respectively?

	Part X	Part Y
(1)	A	D
(2)	B	D
(3)	B	C
(4)	C	A

- 12 The diagram below shows fertilisation taking place in human reproduction. Which of the labelled parts, A, B, C and D, will fuse and eventually develop into a foetus?

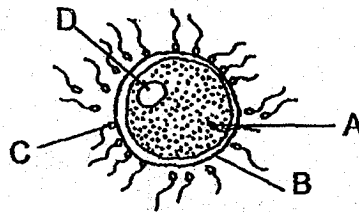

- (1) A and B only
- (2) A and D only
- (3) B and C only
- (4) B and D only

- 13 Study the diagram below.

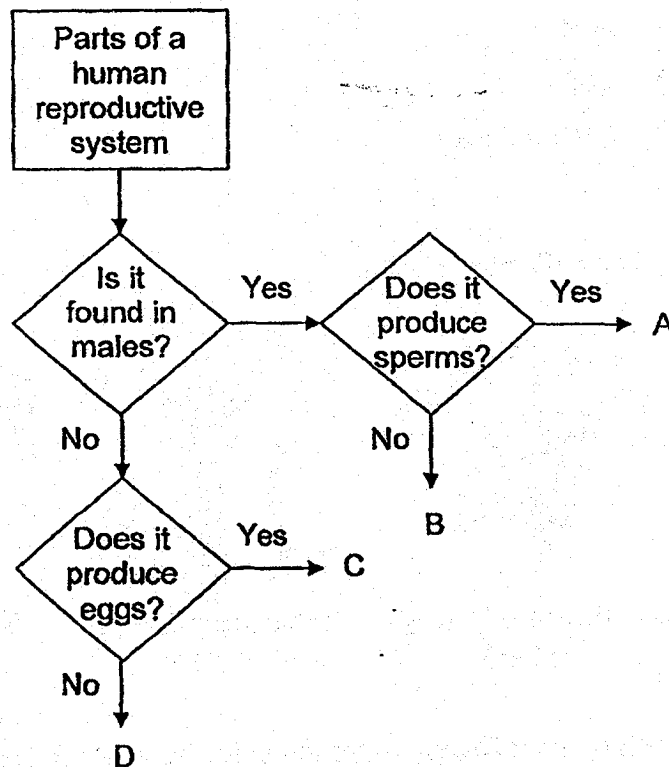

Which one of the following correctly identifies organs A, B, C and D?

	A	B	C	D
(1)	vagina	ovary	testis	penis
(2)	testis	vagina	penis	ovary
(3)	penis	testis	vagina	ovary
(4)	testis	penis	ovary	vagina

- 14 Muthu hung a 5 g weight onto three strings of different materials. The strings were of the same length and thickness. He continued to add more 5 g weights onto each of the strings and recorded the maximum number of weights each string could hold before it snapped.

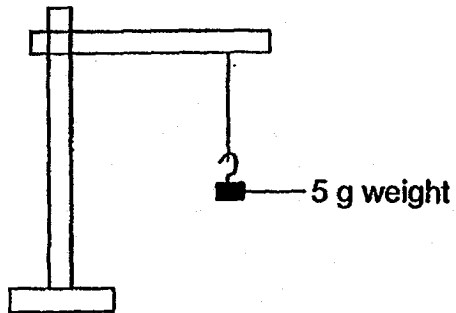

Which property of materials was Muthu testing?

- (1) strength
- (2) flexibility
- (3) waterproof
- (4) transparency

15 Study the diagram below.

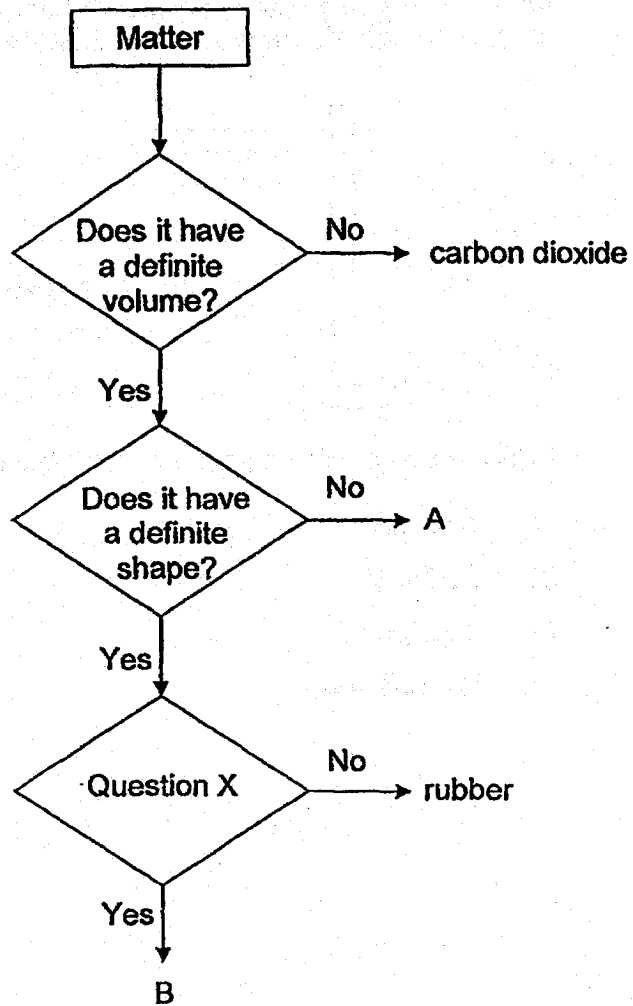

What could A, Question X and B be?

	A	Question X	B
(1)	water	Is it a magnetic material?	iron
(2)	air	Is it a good conductor of heat?	aluminium
(3)	oxygen	Does it conduct electricity?	iron
(4)	oil	Is it a magnetic material?	aluminium

- 16 Iman attached Magnets P, Q, R and S on top of each toy car A, B, C and D as shown below.

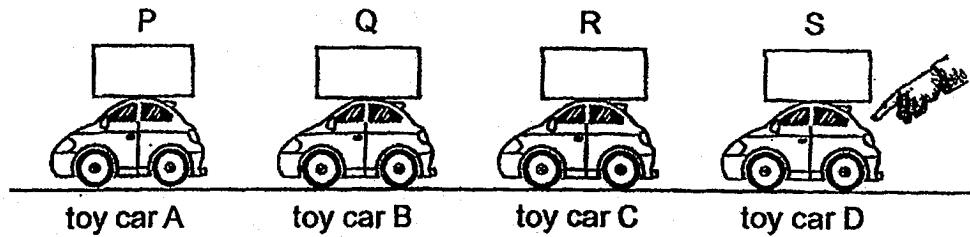

The toy cars moved at a distance away from each other when Iman pushed only toy car D. Which one of the following diagrams below shows how the magnet on each car was arranged?

(1)

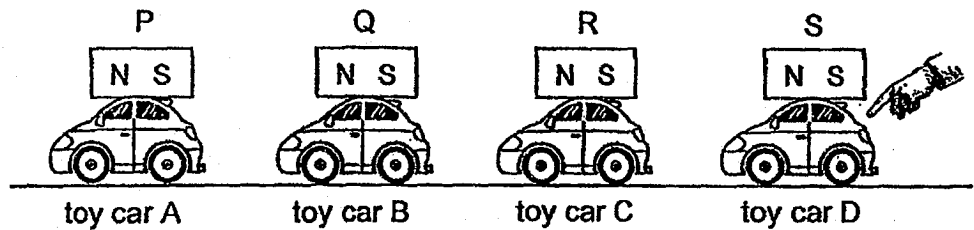

(2)

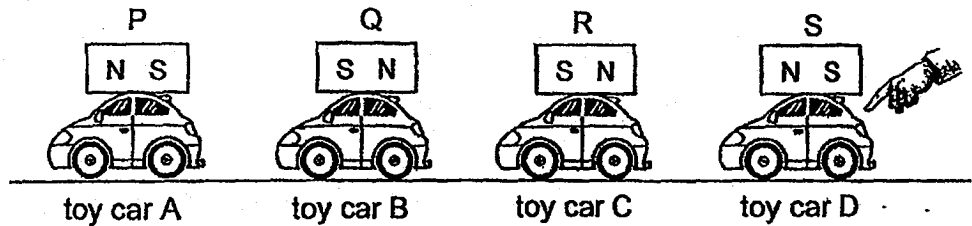

(3)

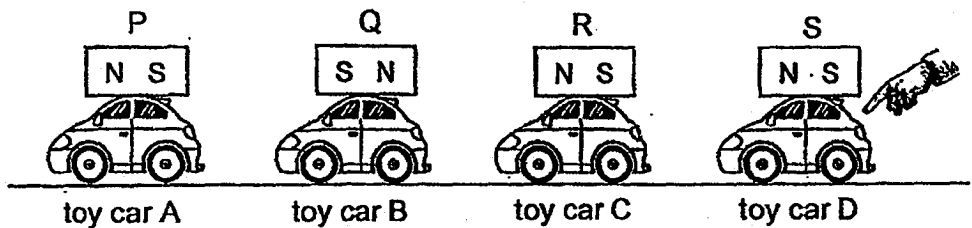

(4)

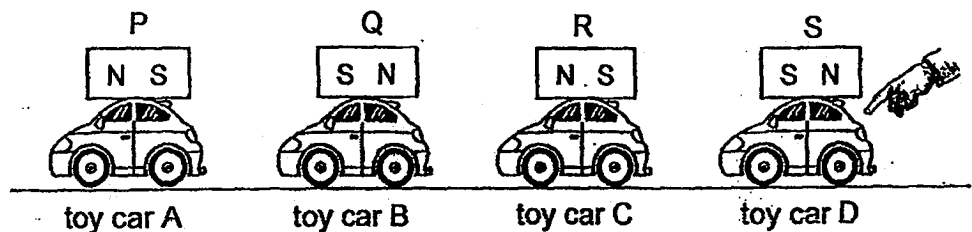

- 17 Lixin placed magnet A at a starting point and a paper clip at a distance away from the magnet, as shown below.

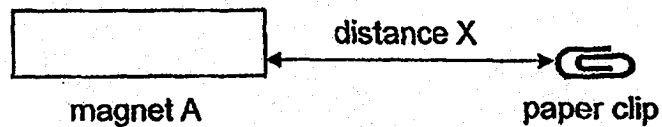

Lixin moved the paper clip slowly towards magnet A. She recorded distance X, the greatest distance at which the magnet attracted the paper clip.

She repeated her experiment with three other magnets, B, C and D, as shown below.

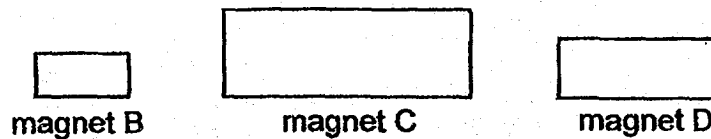

The table below shows the results of her experiment.

Magnet	A	B	C	D
Distance X (cm)	2	7	5	8

Based on the results, which of the following statements are correct?

- A Magnet D is stronger than magnet B.
- B Magnet A is the strongest among all the magnets.
- C The strength of the magnet is not affected by its size.
- D Only magnet C can attract paper clips which are 5 cm away.

- (1) A and C only
- (2) B and C only
- (3) B and D only
- (4) A, C and D only

- 18 Dev was walking along a dark street on a moonless night. He noticed that the length of his shadow changed as he walked in the direction of the arrow shown in the diagram below.

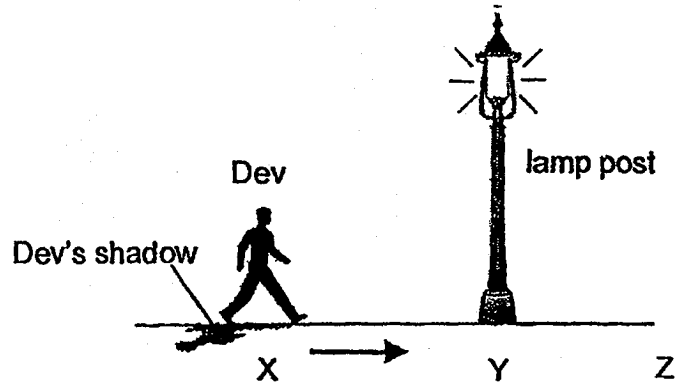

Which one of the following graphs correctly shows the changes in the length of Dev's shadow as he walked from point X to point Z?

(1)

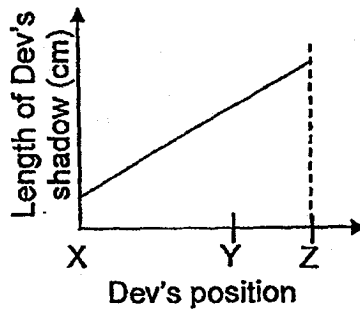

(2)

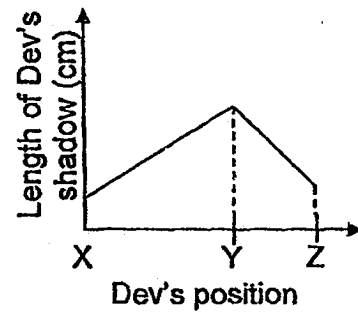

(3)

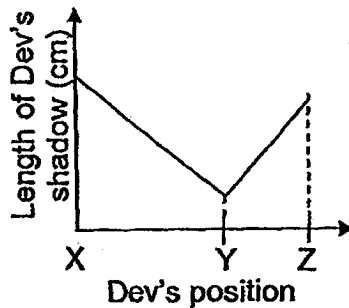

(4)

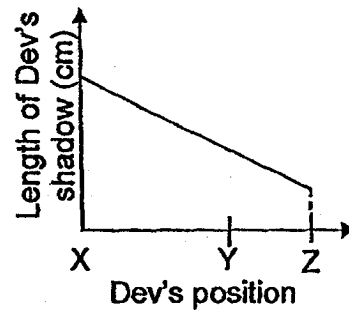

- 19 Two beakers containing different volumes of water at room temperature were heated until both beakers of water reached 50°C .

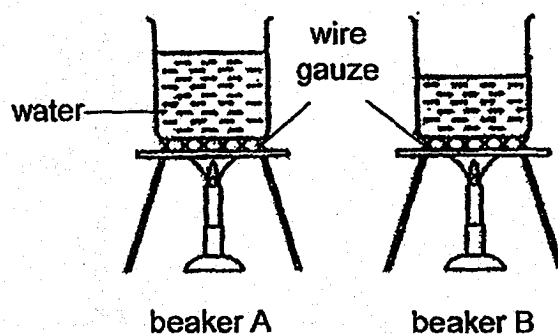

Which of the following statements is/are correct?

- A The water in beaker B took a shorter time to be heated to 50°C .
- B The water in beakers A and B had the same amount of heat energy.
- C The water in beaker A had more heat energy than the water in beaker B.
- D The water in beaker A had gained heat faster than the water in beaker B.

- (1) B only
- (2) A and C only
- (3) C and D only
- (4) A, B and D only

- 20 Sanjay conducted an experiment as shown below. The set-up consisted of three beakers containing the same amount of water at different temperatures. He recorded the time taken for the first water droplet to fall from the glass lids.

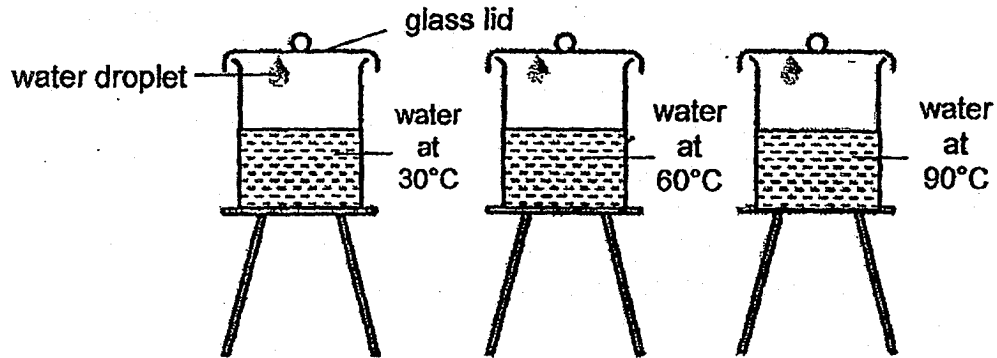

The table below shows the observations made by Sanjay.

Temperature of the water (°C)	Time taken for the first water droplet to fall (min)
30	3.5
60	1.5
90	0.5

What is the aim of Sanjay's experiment?

- (1) To find out how the amount of water in the beakers affects the rate of evaporation of the water.
- (2) To find out whether the size of the glass lid affects the time taken for the water droplets to form.
- (3) To find out how the room temperature affects the rate of condensation of the water vapour.
- (4) To find out how the temperature of water in the beaker affects the time taken for the first water droplet to fall.

21 The diagram below shows the water cycle.

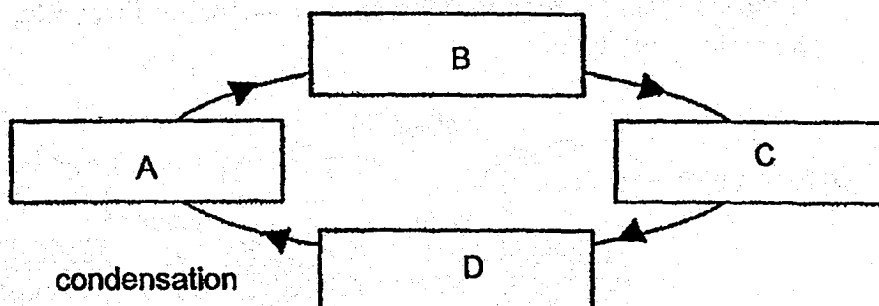

What does A represent?

- (1) rain
- (2) clouds
- (3) water vapour
- (4) water on earth

22 Sharmane has a container with two solid substances, X and Y. The table below shows the melting point and boiling point of the two substances.

Substance (°C)	Melting point (°C)	Boiling point (°C)
X	42	78
Y	28	63

At which temperature should Sharmane heat the mixture such that one substance becomes a liquid and the other substance remains as a solid?

- (1) 32°C
- (2) 60°C
- (3) 75°C
- (4) 80°C

- 23 Process A takes place when an ice cube is left in the room unattended. Process B takes place when a bottle of water is placed in a freezer.

Which of the following correctly describes Processes A and B?

	Process A	Process B
(1)	The ice cube loses heat to the warmer surroundings and melts.	Water <u>loses</u> heat to the colder surroundings and freezes.
(2)	The ice cube loses heat to the warmer surroundings and melts.	Water gains heat from the colder surroundings and freezes.
(3)	The ice cube gains heat from the warmer surroundings and melts at 0°C .	Water loses heat to the colder surroundings and freezes at 0°C .
(4)	The ice cube gains heat from the warmer surroundings and melts at 0°C .	Water gains heat from the colder surroundings and freezes at 0°C .

- 24 A circuit comprising identical bulbs, batteries and switches was set up as shown in the diagram below.

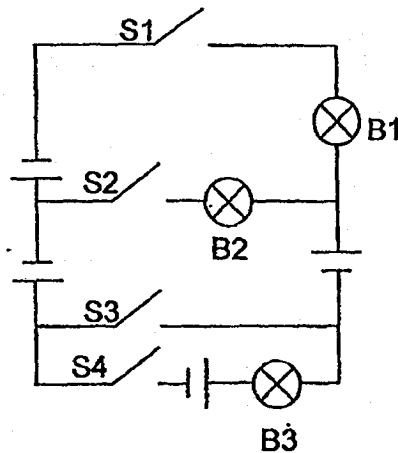

Which of the following pairs of switches, when closed, would cause only one bulb to light up?

- A S1 and S3
 B S1 and S4
 C S2 and S3
 D S2 and S4
- (1) A and B only
 (2) A and C only
 (3) B and D only
 (4) C and D only

- 25 The diagram below shows an electrical circuit that consists of four objects, A, B, C and D, made of different materials.

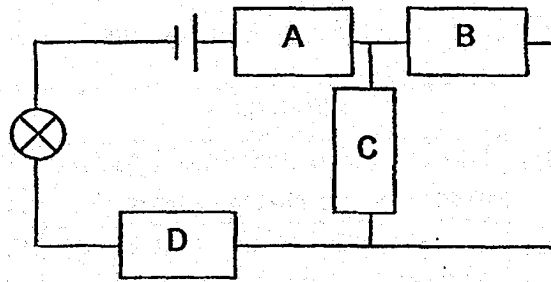

It was observed that the bulb lit up. Which one of the following correctly represents the materials that A, B, C and D could be made of?

	A	B	C	D
(1)	iron	paper	wood	copper
(2)	copper	aluminium	iron	paper
(3)	paper	copper	iron	wood
(4)	aluminium	iron	wood	copper

- 26 Bulbs B1, B2 and B3, and switches S1, S2 and S3 are connected in a circuit as shown. All the bulbs are working properly.

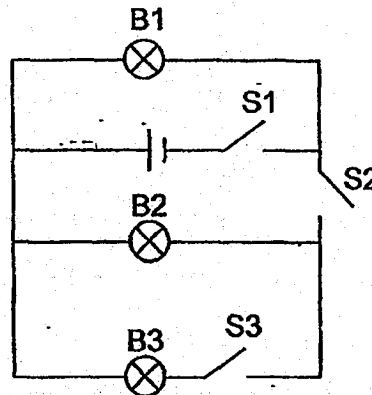

Which one of the following is correct?

	Switches			Do the bulbs light up?		
	S1	S2	S3	B1	B2	B3
(1)	closed	open	closed	yes	no	yes
(2)	open	open	closed	no	no	yes
(3)	closed	closed	open	yes	yes	no
(4)	open	closed	open	no	yes	no

27 Devon set up the circuit as shown below.

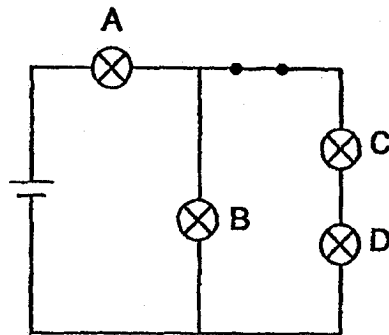

He made the following statements about the circuit.

- A Bulb C and Bulb D are in series.
- B Bulb A and Bulb B are in parallel.
- C Bulb B and Bulb D are in parallel.
- D If the switch is turned off, only Bulb A and Bulb B will light up.

Which statement(s) is/are correct?

- (1) A only
- (2) B and C only
- (3) A, C and D only
- (4) A, B, C and D

- 28 Study the four electrical circuits as shown below. All the batteries and bulbs are similar.

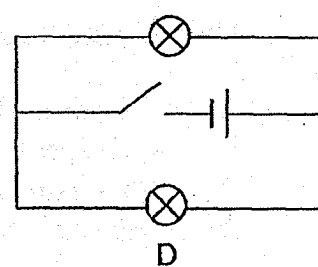
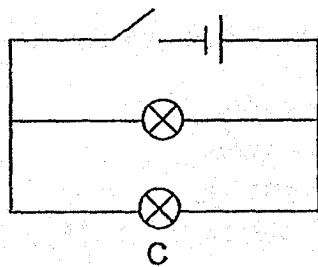
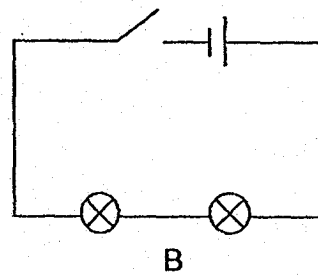
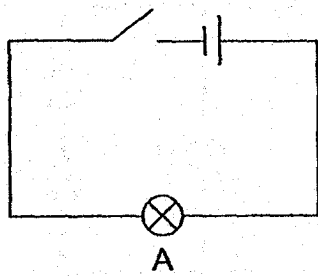

In which circuits will the bulbs be of the same brightness?

- (1) A and B only
- (2) B and C only
- (3) A, C and D only
- (4) B, C and D only

End of Booklet A



CATHOLIC HIGH SCHOOL
SEMESTRAL ASSESSMENT ONE (2018)
PRIMARY FIVE
SCIENCE
BOOKLET B

Name: _____ ()

Class: Primary 5 - _____

Date: 11 May 2018

Parent's Signature: _____

Booklet A	56
Booklet B	44
Total	100

13 questions

44 marks

Total Time for Booklets A and B: 1 hour 45 minutes

INSTRUCTIONS TO CANDIDATES

Do not turn over this page until you are told to do so.

Follow all instructions carefully.

Answer all questions.

Write your answers in this booklet.

This booklet consists of 15 printed pages, excluding the cover page.

Booklet B (44 marks)

For questions 29 to 41, write your answers in this booklet.

The number of marks available is shown in brackets [] at the end of each question or part question. (44 marks)

- 29 Kim conducted an experiment as shown below. She placed the mealworm on side X of the tray. The tray was left in a brightly lit room for five minutes. She then observed that the mealworm moved towards side Y.

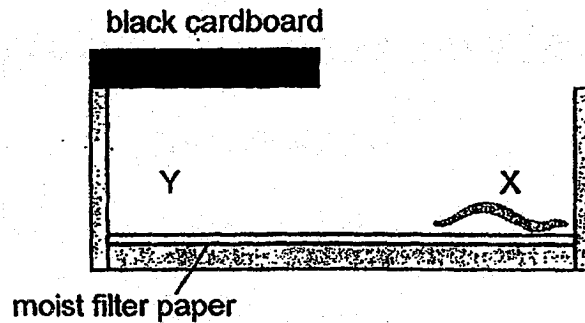

- (a) If Kim moved the black cardboard over to side X, describe what she would likely observe after ten minutes. [1]

- (b) Based on Kim's observation, state one characteristic of living things. [1]

- (c) What would happen to the mealworm after two days if the moist filter paper was removed? Give a reason for your answer. [1]

(Go on to the next page)

SCORE	3
-------	---

30 The diagram below shows the human digestive system.

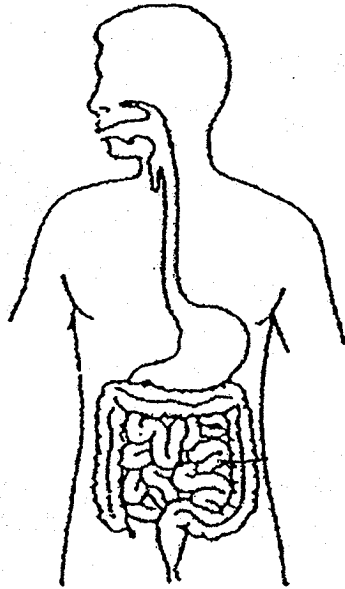

- (a) On the diagram, label and name the part of the system where most of the digested food is absorbed into the body. [1]
- (b) State how our digestive system and circulatory system work together to supply digested food to our body parts. [2]

(Go on to the next page)

SCORE	3
-------	---

31 Study the life cycles of a chicken and a mosquito as shown below.

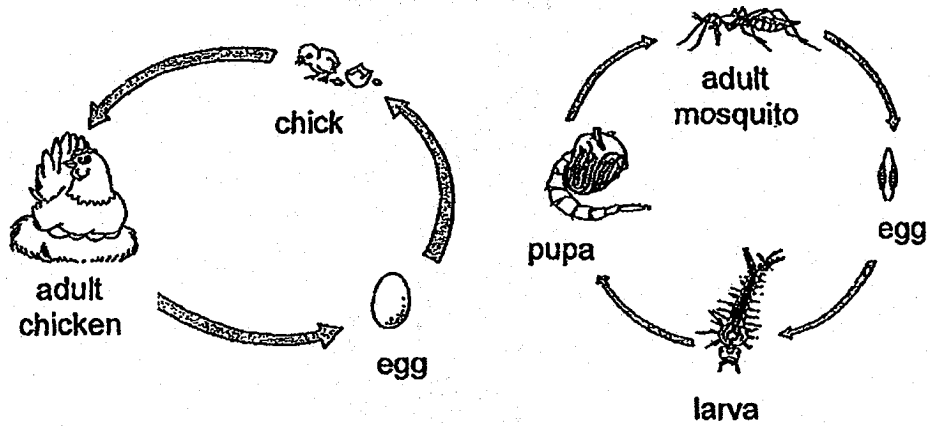

Based on the diagram above, state one similarity and one difference [2]
between the life cycle of a chicken and a mosquito.

Similarity:

Difference:

(Go on to the next page)

SCORE	2
-------	---

32 The diagram below shows one of the shorea fruits which Vince had.



(a) How does part X help the shorea fruit to disperse its seed? [2]

Vince wanted to investigate how the length of part X of the shorea fruit affects the time taken for it to reach the ground. He dropped each of the following shorea fruits from a height. The table below showed what he did to the shorea fruits B and C.

shorea fruit A	shorea fruit B	shorea fruit C
No change	1 cm of part X was trimmed off	2 cm of part X was trimmed off
Took 15 seconds to reach the ground	Took 9 seconds to reach the ground	Took 5 seconds to reach the ground

(b) What is the relationship between the length of part X of the shorea fruit and the time taken for it to reach the ground? [1]

(c) Write down two variables which he should keep constant for his experiment to be a fair test. [1]

(i) _____

(ii) _____

(Go on to the next page)

SCORE	4
-------	---

- 33 Gary was given four similar-sized unknown objects, A, B, C and D, individually wrapped in black paper. He then held a magnet about 2 cm away from Object A as shown in the diagram below. He repeated the experiment with objects B, C and D. He recorded his observations in the table below.

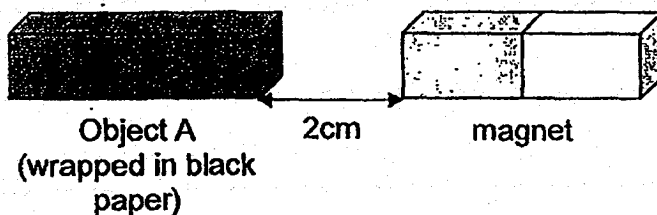

Object	Observation
A	It remained still.
B	It moved away from the magnet.
C	It moved towards the magnet.
D	It moved away from the magnet.

- (a) Which one of the objects, A, B, C or D, could be made of plastic? [1]
Explain your choice.

- (b) Without having to carry out further testing, and based on the [1]
observations recorded, Gary concluded that objects B and D are
magnets. Is his conclusion correct? Explain why.

- (c) Gary's friend, Tommy, pointed out that Gary should carry out further [1]
testing on Object C to determine if Object C is a magnet. Without
adding in more apparatus or equipment, what should Gary do to
determine whether Object C is a magnet?

(Go on to the next page)

SCORE	3
-------	---

34 Alex placed a balloon into a plastic bottle as shown below.

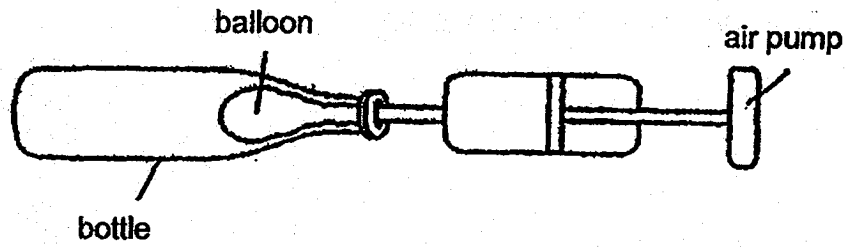

(a) Alex tried inflating the balloon using the air pump but found it difficult to do so. Explain why. [1]

(b) What can Alex do to make it easier for him to inflate the balloon within the plastic bottle? [1]

(c) Explain your answer in (b). [1]

(Go on to the next page)

SCORE	3
-------	---

- 35 John conducted an experiment to find out how much light can pass through four different materials P, Q, R and S using a datalogger with a light sensor as shown in the diagram below.

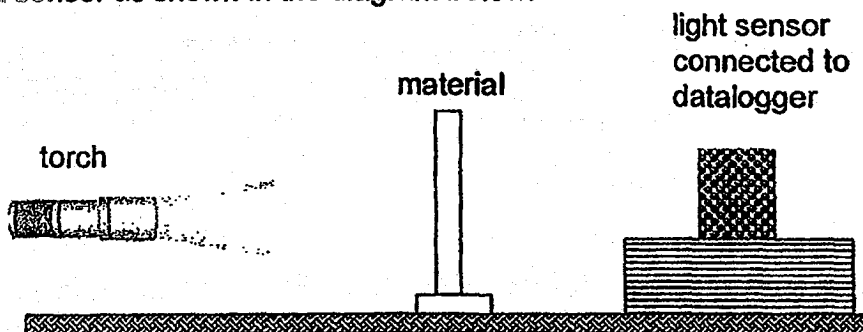

He tested each material one at a time and recorded the amount of light detected by the datalogger. He recorded his results and plotted the graph as shown below.

Amount of light (unit)

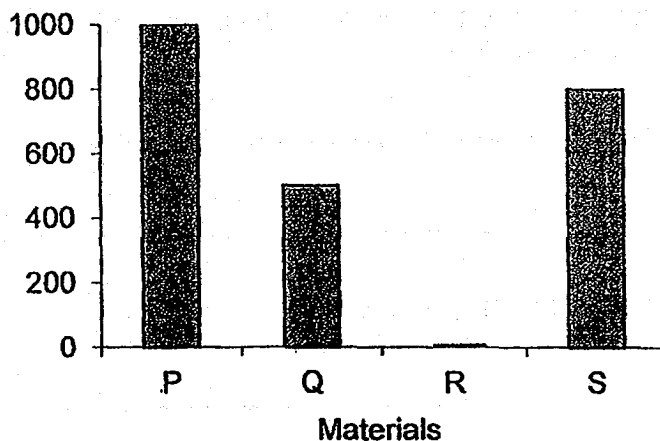

- (a) The sun comes directly into John's bedroom every morning. He wants to make his room the dimmest. Based on the results, which material P, Q, R or S is most suitable to be used as curtains for his windows? Give a reason for your choice. [1]

- (b) Give a reason why John should conduct his experiment in a [1] completely dark room to ensure a fair test.

(Go on to the next page)

SCORE	2
-------	---

- 36 Cups A and B, each made of different materials, were filled with the same amount of water at 3°C at the same time. Cup B felt colder than cup A when touched and water vapour condensed on cup B more quickly than on A.

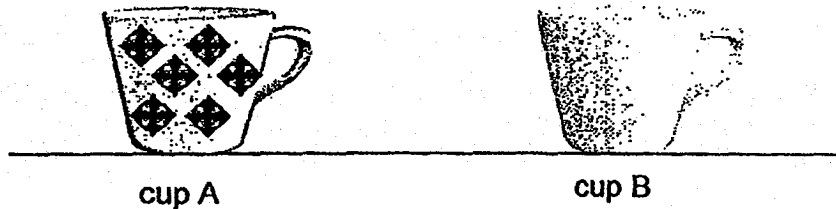

Both cups were left in a room at 30°C . The temperature of water in both cups was measured every five minutes.

The table below shows the changes in the temperature of water in cup A over a period of 20 minutes.

Time (min)	0	5	10	15	20
Temperature of water ($^{\circ}\text{C}$)	3	10	12	16	19

- (a) Would the temperature of the water in cup B be higher, lower than or the same as 19°C at the 20th minute? Explain your answer. [2]

- (b) Which cup, A or B, would be more suitable to use for keeping coffee warm? Explain your answer. [2]

(Go on to the next page)

SCORE	4
-------	---

- 37 The table below shows the freezing point and boiling point of three substances, X, Y and Z.

Substance	Freezing point ($^{\circ}\text{C}$)	Boiling point ($^{\circ}\text{C}$)
X	20	120
Y	150	300
Z	0	10

Rina worked in a laboratory with a room temperature of 30°C . She was able to store 2000 cm^3 of a substance into a container with a capacity of 1000 cm^3 .

- (a) Which substance, X, Y or Z, did she use? Explain your answer. [1]

Rina had a wire mesh basket as shown below.



- (b) Would she be able to store substances X and Y into the wire mesh basket at room temperature? Explain your answer. [2]

(Go on to the next page)

SCORE	3
-------	---

Continue from question 37

The diagram below shows the three states of a substance.

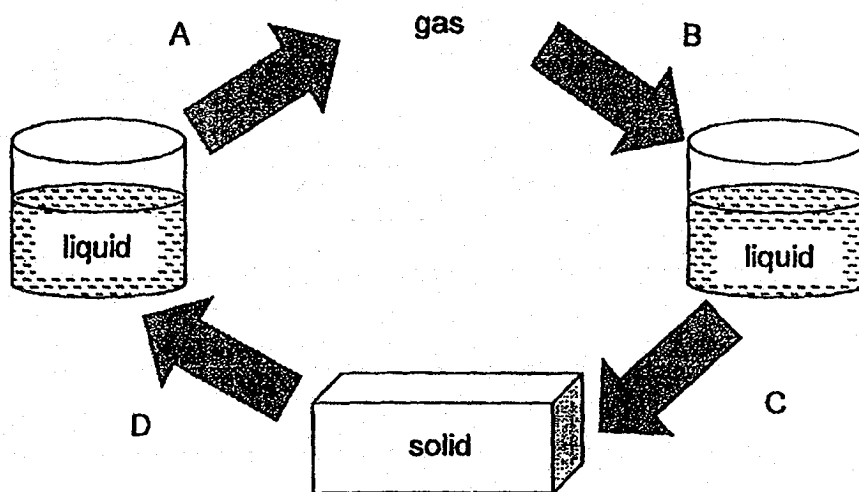

(c) Put a tick (✓) in the appropriate boxes below.

[2]

Processes	Heat gain	Heat loss
A		
B		
C		
D		

(Go on to the next page)

SCORE	2
-------	---

- 38 The diagram below shows how the water cycle recycles the water from the earth. The arrows show the different stages of water in motion.

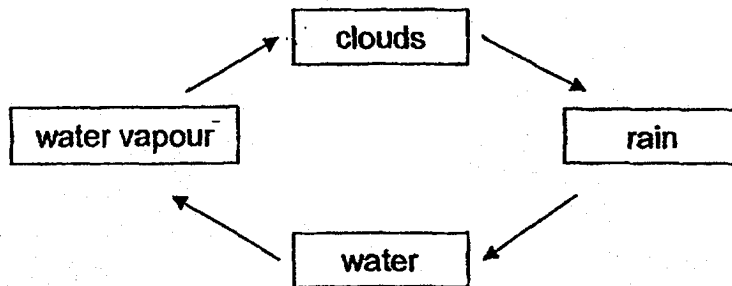

- (a) Explain how plants can be part of the water cycle. [2]

Jessie took out some ice cubes from the freezer and boiled some water in a kettle.

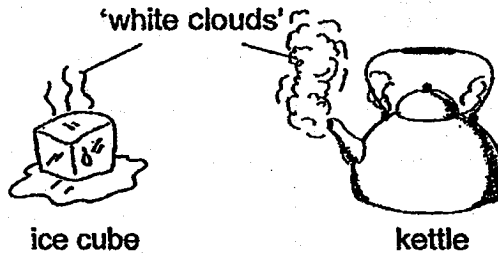

She noticed 'white clouds' forming above the ice cube and spout of the kettle.

- (b) Name the process that caused the 'white clouds' to form. [1]

- (c) Explain how the 'white clouds' were formed above the ice cube and the kettle. [2]

Ice cube: _____

Kettle: _____

(Go on to the next page)

SCORE	5
-------	---

- 39 William hung an iron bell near an iron bar as shown in the diagram below. When William closed the switch, the iron bell rang.

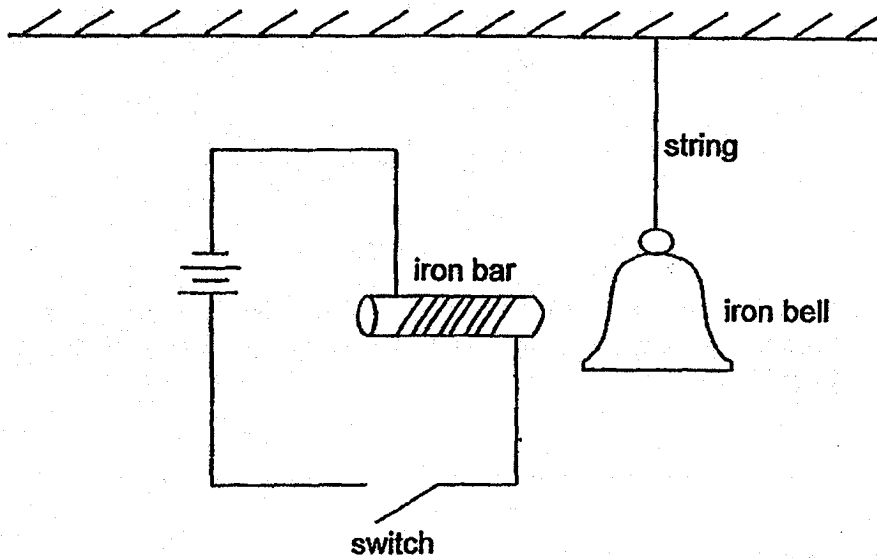

- (a) Explain why the iron bell rings each time the switch is turned on. [2]

- (b) William replaced the iron bar with another bar Q. When he closed the switch, the iron bell did not move at all. [1]
Based on the above result, state one property of the material of bar Q.

(Go on to the next page)

SCORE	3
-------	---

40 Ethan set up Circuit 1 as shown below.

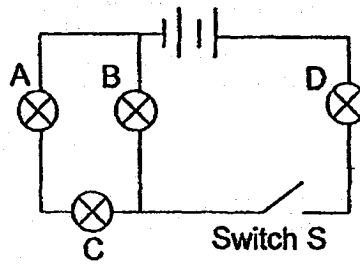

Circuit 1

- (a) He then closed Switch S and all the bulbs lighted up. One of the bulbs then fused and all the bulbs went off. Which bulb might have fused? [1]

Ethan then set up Circuit 2 as shown below.

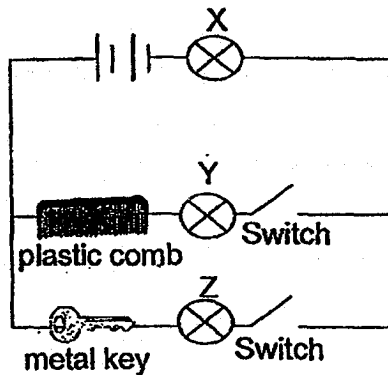

Circuit 2

- (b) Complete the table below to show which bulbs will light up when different switches are open or closed. Put a tick (✓) if the bulb lights up or a cross (X) if the bulb does not light up in the appropriate boxes below. [1]

Switch 1	Switch 2	Bulb X	Bulb Y	Bulb Z
open	open	X	X	X
open	closed			
closed	open			

(Go on to the next page)

SCORE	2
-------	---

Continue from question 40

- (c) Using only 2 batteries, 3 bulbs, 1 switch and some wires, Ethan then set up Circuit 3 which allows the switch to control all the bulbs at the same time, and yet if one bulb fuses, the other bulbs can still light up. Draw a circuit diagram to represent Circuit 3 in the box below. [2]

Circuit 3

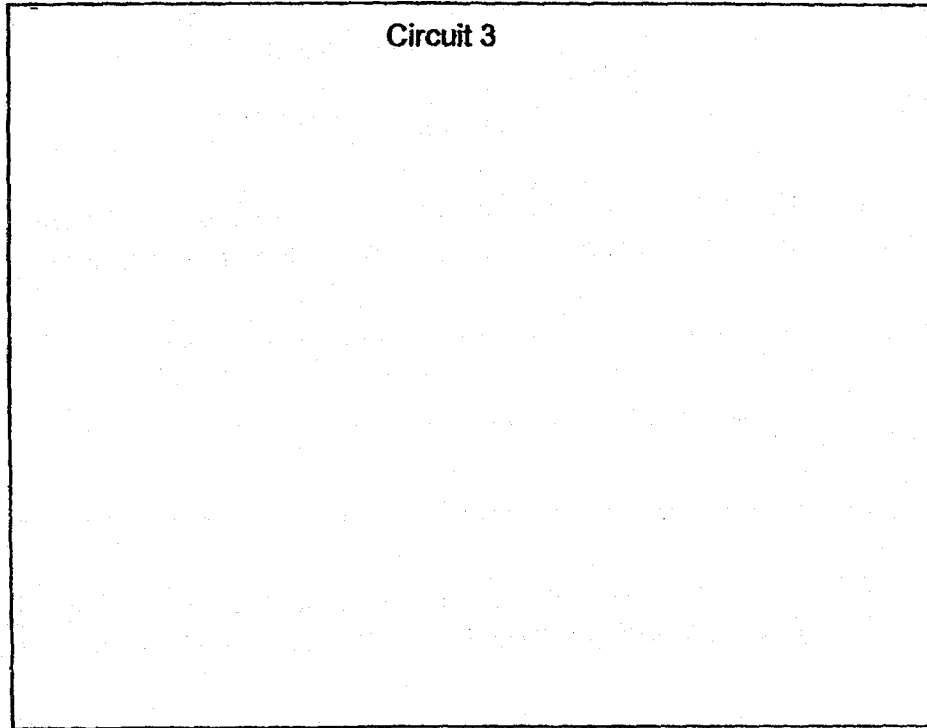

(Go on to the next page)

SCORE	2
-------	---

- 41 Kelly set up a circuit as shown below. She placed some iron paper clips at equal distance below the electromagnet.

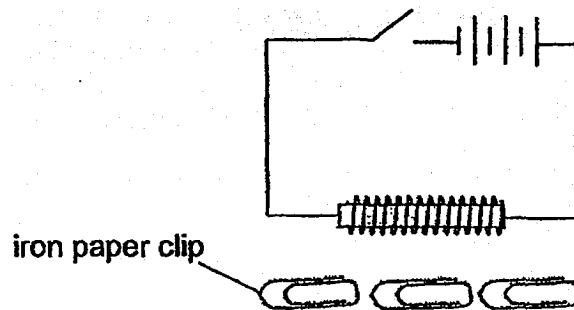

- (a) What would happen to the number of paper clips attracted if the number of batteries was decreased? Give a reason for your answer. [2]

- (b) Kelly replaced the iron paper clips with aluminium paper clips. [1] Describe what she would observe when she closed the switch.

End of Booklet B

SCORE	3
-------	---

SCHOOL : CATHOLIC HIGH PRIMARY SCHOOL
LEVEL : PRIMARY 5
SUBJECT : SCIENCE
TERM : 2018 SA1

SECTION A

Q 1	Q2	Q3	Q4	Q5	Q6	Q7	Q8	Q9	Q10
2	1	3	3	4	4	2	1	2	1
Q 11	Q12	Q13	Q14	Q15	Q16	Q17	Q18	Q19	Q20
3	2	4	1	1	4	1	3	2	4
Q 21	Q22	Q23	Q24	Q25	Q26	Q27	Q28		
2	1	3	2	4	3	3	3		

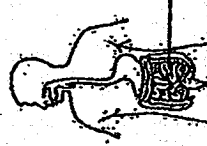
Qn	Answer
29a	<ul style="list-style-type: none"> • The mealworm moved to side X. • The mealworm moved from side Y to side X.
b	Living things respond to changes in their surroundings.
c	<p>(1st gn)</p> <ul style="list-style-type: none"> • The mealworm would die. • The mealworm would not live / survive. <p>(2nd gn)</p> <ul style="list-style-type: none"> • There is no water / moisture present for survival.
30a	 <p>— small intestine</p>
b	<p>(Digestive system)</p> <ul style="list-style-type: none"> • Digested food is <u>absorbed into the bloodstream / blood</u> in the small intestine. <p>(Circulatory system)</p> <ul style="list-style-type: none"> • Digested food is <u>carried / transported</u> in the bloodstream / blood to all parts of the body.
31	<p>(Similarity)</p> <ul style="list-style-type: none"> • Both life cycles have the egg stage. <p>(Difference)</p> <ul style="list-style-type: none"> • The chicken has three stages in its life cycle but the mosquito has four stages in its life cycle. • The mosquito has the larval and pupal stages but the chicken does not have the larval and pupal stages. • The young of a chicken resembles the adult but the young of a mosquito does not resemble the adult. <p>Unacceptable answers</p> <ul style="list-style-type: none"> • Both life cycles start with the egg stage. (This is a misconception.) • Both adults do not give birth to young. (This is a characteristic of the adults. The question is asking for a comparison between the two life cycles.)

Qd	Answer	Feedback / Notes
32a	<p>(Structure) Part X / Wing-like structure (Function of structure) It allows the fruit to stay afloat in the air for a longer time. (Reason) The fruit is dispersed further away from the parent plant.</p>	<p>Why do fruits / seeds need to be dispersed? To avoid overcrowding so as to reduce competition for space, sunlight, water and nutrients with the parent plant.</p>
b	<ul style="list-style-type: none"> As the length of part X of the shorea fruit increases, the time taken for it to reach the ground increases. As the length of part X of the shorea fruit decreases, the time taken for it to reach the ground decreases. 	<p>This is a causal relationship between two variables. CAUSE / CHANGED VARIABLE: length of part X of shorea fruit EFFECT / MEASURED VARIABLE: time taken for shorea fruit to reach the ground</p>
c	<ul style="list-style-type: none"> Mass / Weight of shorea fruit Height at which the shorea fruit was dropped Presence of wind / Wind speed / Location of investigation 	<p>Unacceptable answers</p> <ul style="list-style-type: none"> Type of fruit (This is mentioned in the question stem.) Size of shorea fruit (The fruits may be of the same size but each of them has a different mass / weight.)
33a	<p>(Choice) Object A (Evidence from the table of results) Since it remained still, it is not attracted to the magnet. (Reasoning) It is made of a non-magnetic material.</p>	
b	<p>(Choice) Objects B and D are magnets. (Evidence from the table of results) Since both moved away from the magnet, there is repulsion taking place. (Reasoning) Only a magnet can repel another magnet when the like poles of each are facing each other.</p>	
c	<p>He should face one end of Object C to the other end of the magnet. Object C is a magnet if any one end repels the magnet.</p>	<p>Unacceptable answer</p> <ul style="list-style-type: none"> He should turn / flip Object C around. (This action that is described is not clear. It may be misconstrued as turning / flipping on the sides of Object C.)
34a	<p>There is air occupying the space in the bottle and the air cannot escape.</p>	
b	<p>Poke some holes on the bottle.</p>	
c	<p>Air in the bottle is able to escape through the holes hence there is space for the balloon to be inflated.</p>	

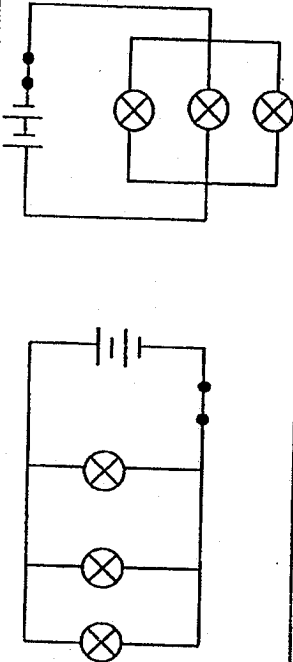
Qn	Answer	Feedback/Notes																				
38a	Water is absorbed / taken in by the plants. They give off water vapour to the surroundings.																					
b	Condensation																					
c	Ice cube: Water vapour in the surroundings loses heat to the <u>cool</u> surroundings near the ice cube and <u>condenses</u> to form 'white clouds' / water droplets. Kettle: Steam / hot water vapour loses heat to the <u>cool</u> surroundings outside the kettle and <u>condenses</u> to form 'white clouds' / water droplets.																					
39a	When the switch is turned on, the circuit becomes <u>close</u> hence electric current can flow through the circuit. The iron bar becomes an electromagnet / temporary magnet / magnet / magnetised and attracted the iron bell to it.	You have to state is the circuit is close or open before you mention electric current flow.																				
b	The material of bar Q is non-magnetic.																					
40a	Bulb D																					
b	<table border="1" data-bbox="938 1249 1129 1995"> <thead> <tr> <th>Switch</th> <th>Bulb A</th> <th>Bulb X</th> <th>Bulb B</th> <th>Bulb Z</th> </tr> </thead> <tbody> <tr> <td>open</td> <td>X</td> <td></td> <td>X</td> <td>X</td> </tr> <tr> <td>open</td> <td>✓</td> <td></td> <td>X</td> <td>✓</td> </tr> <tr> <td>close</td> <td>X</td> <td></td> <td>X</td> <td>X</td> </tr> </tbody> </table>	Switch	Bulb A	Bulb X	Bulb B	Bulb Z	open	X		X	X	open	✓		X	✓	close	X		X	X	 <p data-bbox="938 948 954 969">c</p>
Switch	Bulb A	Bulb X	Bulb B	Bulb Z																		
open	X		X	X																		
open	✓		X	✓																		
close	X		X	X																		
41a	(1 st qn) The number of paper clips attracted decreases: (2 nd qn) As the number of batteries decreases, there is less electric current flowing through the circuit hence the electromagnet has less magnetic strength / force.																					
b	No paper clips were attracted to the electromagnet.	<p data-bbox="1377 721 1409 980"><u>Unacceptable answers</u></p> <ul data-bbox="1417 327 1449 938" style="list-style-type: none"> • Nothing happened / The paper clips did not move. 																				

Qn	Answer	Feedback/Notes															
35a	<p>(Choice) Material R (Evidence from the graph) The amount of light detected by the datalogger is the <u>least</u>.</p>	<p>Since the question is only asking for a reason and not an explanation, the reasoning in the answer is not required.</p>															
b	<ul style="list-style-type: none"> To ensure that the light detected by the datalogger is <u>only</u> the light from the torch that passes through the material. To ensure that no other light sources are detected by the datalogger except for the light from the torch passing through the material. 																
36a	<p>(Choice / Evidence) Temperature of the water in Cup B would be higher than 19°C. (Reasoning)</p> <ul style="list-style-type: none"> Material of Cup B is a better conductor of heat. The water in the cup <u>gains heat more quickly from the surroundings.</u> Material of Cup B is a better conductor of heat. It <u>conducts heat more quickly from the surroundings to the water.</u> 	<p>Do ensure that your answer informs the direction of heat flow. ... gains heat from (where) ... loses heat to ... (where)</p>															
b	<p>(Choice) Cup A (Evidence is mentioned in part a) (Reasoning)</p> <ul style="list-style-type: none"> Material of Cup A is a poorer conductor of heat. The coffee in the cup <u>loses heat more slowly to the surroundings.</u> Material of Cup A is a poorer conductor of heat. It <u>conducts heat more slowly from the coffee to the surroundings.</u> 																
37a	<p>(Choice) Substance Z (Evidence is mentioned in the question stem) (Reasoning) It is a gas at a room temperature of 30°C hence it can be compressed and be stored in a container with a smaller capacity.</p>																
b	<p>Substance Y is a solid at 30°C hence it can be stored in the basket without escaping through the gaps in the basket. Substance X is a liquid at 30°C hence it can flow through the gaps in the basket.</p>																
c	<table border="1" data-bbox="1252 1388 1444 1947"> <thead> <tr> <th data-bbox="1252 1388 1284 1947">Process</th> <th data-bbox="1284 1388 1316 1947">Material</th> <th data-bbox="1316 1388 1348 1947">Heaps</th> </tr> </thead> <tbody> <tr> <td data-bbox="1284 1750 1316 1947">A</td> <td data-bbox="1316 1750 1348 1947">✓</td> <td data-bbox="1348 1750 1380 1947"></td> </tr> <tr> <td data-bbox="1316 1750 1348 1947">B</td> <td data-bbox="1348 1750 1380 1947"></td> <td data-bbox="1380 1750 1412 1947">✓</td> </tr> <tr> <td data-bbox="1348 1750 1380 1947">C</td> <td data-bbox="1380 1750 1412 1947"></td> <td data-bbox="1412 1750 1444 1947">✓</td> </tr> <tr> <td data-bbox="1380 1750 1412 1947">D</td> <td data-bbox="1412 1750 1444 1947">✓</td> <td data-bbox="1444 1750 1476 1947"></td> </tr> </tbody> </table>	Process	Material	Heaps	A	✓		B		✓	C		✓	D	✓		
Process	Material	Heaps															
A	✓																
B		✓															
C		✓															
D	✓																