

Anglo-Chinese School (Junior)



SEMESTRAL ASSESSMENT 1 (2019)

PRIMARY 5

SCIENCE

BOOKLET A

Friday

17 May 2019

1 hr 45 min

Name: _____

INSTRUCTIONS TO PUPILS

- 1 Do not turn over the pages until you are told to do so.
- 2 Follow all instructions carefully.
- 3 There are 28 questions in this booklet.
- 4 Answer ALL questions.
- 5 Shade your answers in the Optical Answer Sheet (OAS) provided.

This question paper consists of 20 printed pages (inclusive of cover page).

Booklet A

For each question from 1 to 28, four options are given. One of them is the correct answer. Make your choice (1, 2, 3 or 4). Shade your answer on the Optical Answer Sheet. (28 x 2 marks) [56 marks]

1. The classification chart shows how some living things are grouped.

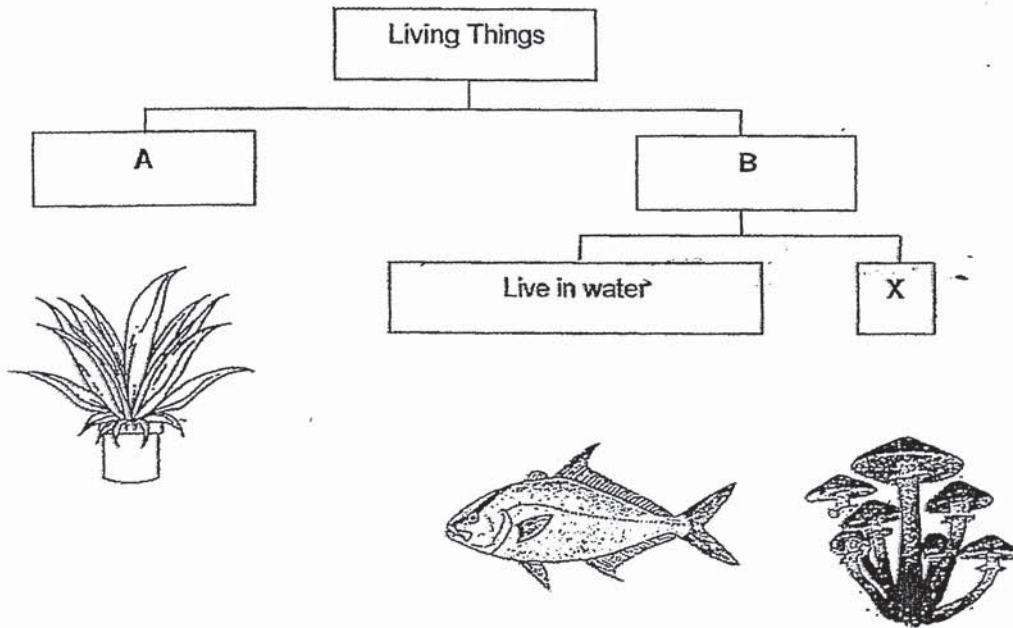

Which of the following are suitable headings for A, B and X?

	A	B	X
(1)	Have chlorophyll	Do not have chlorophyll	Live on land
(2)	Live in water	Feed on smaller living things	Do not make their own food
(3)	Need air and water	Do not need air and water	Absorb nutrients from other organisms
(4)	Reproduce from seeds	Reproduce from spores	Feed on decaying organisms

2. Wendy wanted to find out if plants respond to sunlight. She prepared four set-ups using four similar plants and placed the set-ups in the garden. The plants were given the same amount of water daily.

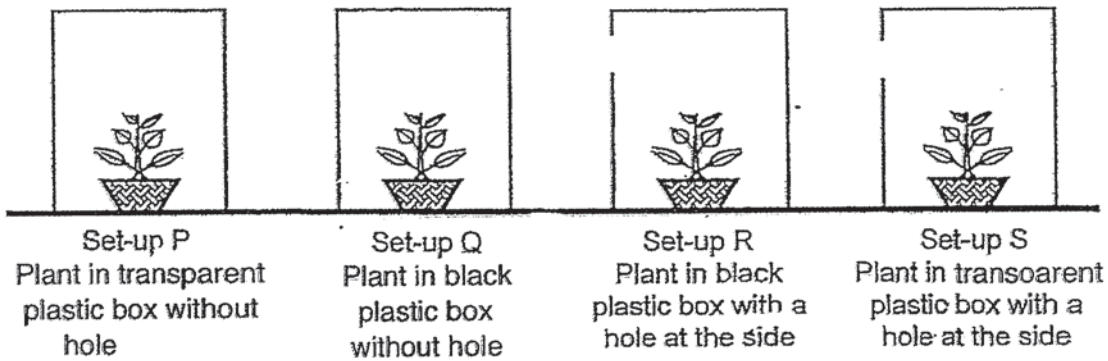

Which two set-ups should Wendy compare to make a conclusion?

- (1) P and Q
 - (2) P and S
 - (3) Q and R
 - (4) Q and S
3. The line graph shows the amount of movement a butterfly makes at various stages of its life cycle.

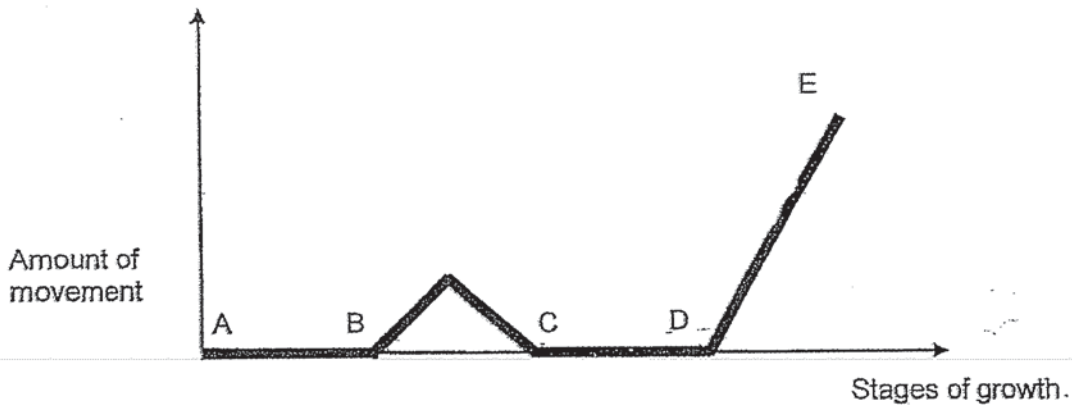

Which part of the line graph most likely shows the stage at which the butterfly could cause damage in a vegetable farm?

- (1) AB
- (2) BC
- (3) CD
- (4) DE

4. Raj conducted an experiment on the growth of mould. He sprinkled 5 drops of water on two similar slices of bread, X and Y. He then placed bread X in the refrigerator and bread Y in the garden.

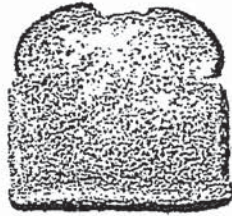

Bread X
Placed in refrigerator

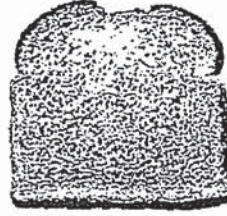

Bread Y
Placed in garden

He noted down his observations in the table.

Day	Observations	
	Bread X	Bread Y
2	No coloured patch	One small green-coloured patch
4	No coloured patch	Two small green-coloured patches
6	No coloured patch	Both patches grew bigger in size.
8	No coloured patch	Both patches grew bigger in size and changed colour from green to black.

The aim of Raj's experiment was to find out if mould needs _____ to reproduce.

- (1) air
- (2) food
- (3) water
- (4) warmth

5. The water hose is used by fire fighters to put out fires in homes, tall buildings and forests.

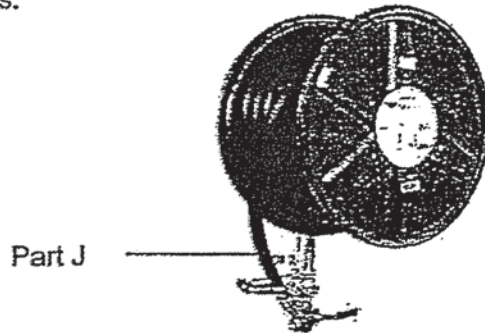

What are the properties of the material which makes it most suitable to make Part J?

- A It is light
- B It is strong
- C It is flexible
- D It is buoyant
- E It is waterproof

- (1) A, B and C only
- (2) B, C and E only
- (3) B, D and E only
- (4) C, D and E only

6. The diagram shows a plant.

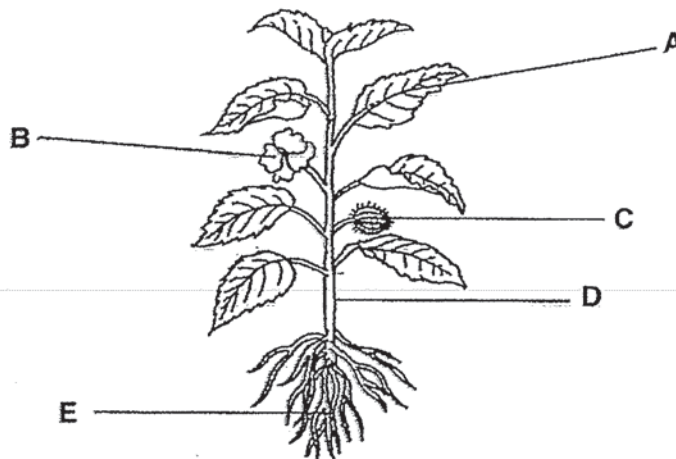

Which parts of the plant work together to enable it to make food?

- (1) A and E only
- (2) B and C only
- (3) A, D and E only
- (4) B, C and D only

7. Which one of the following graphs shows correctly the change in the mass of the seed leaf as a seed germinates?

(1)

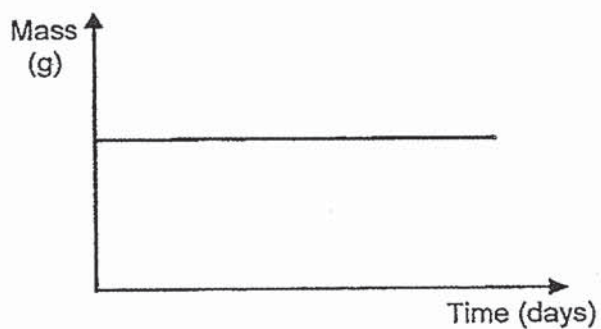

(2)

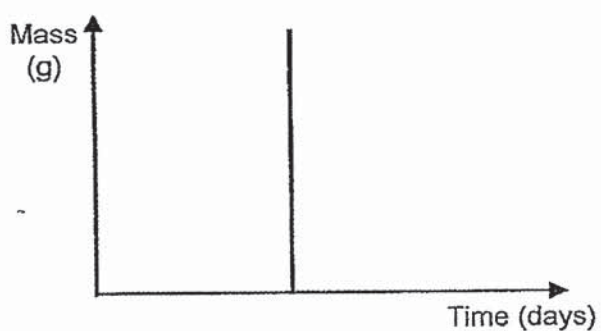

(3)

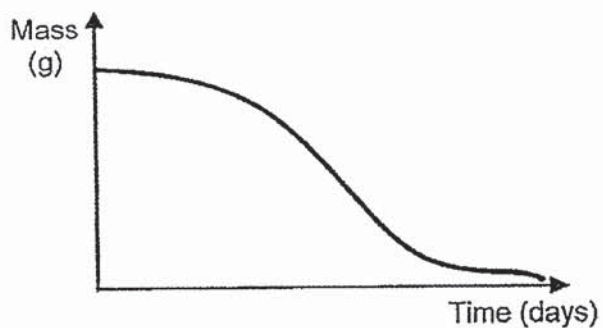

(4)

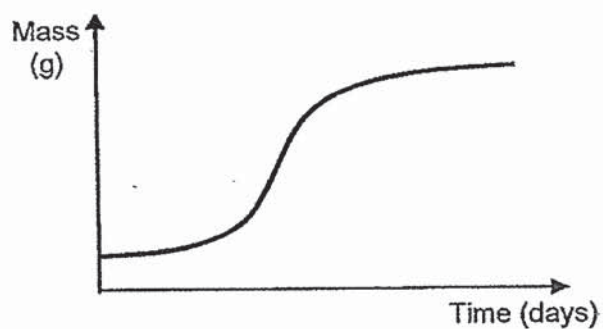

8. Wei Ming poured 200ml of water into a displacement can. He then lowered a stone into it. Some water flowed out of the spout and was collected in the beaker.

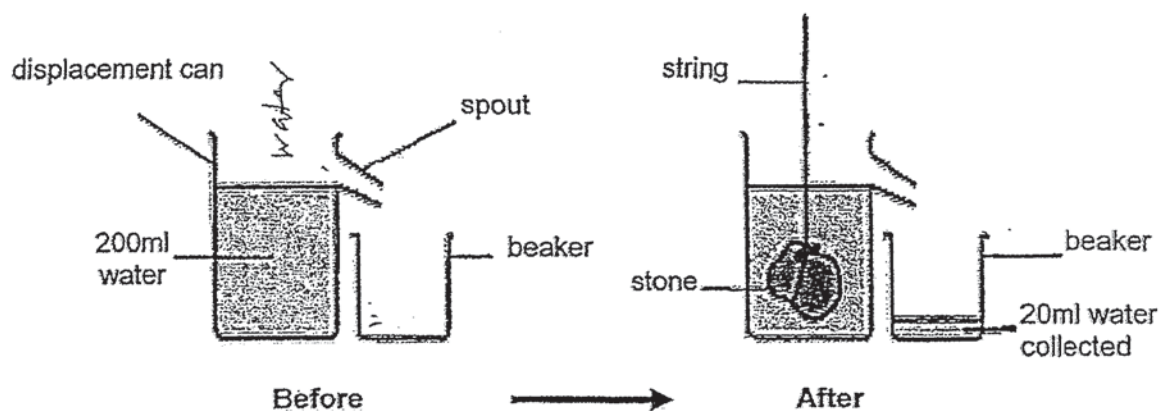

What can Wei Ming infer from the experiment?

- (1) The mass of the stone is equal to the mass of the water in the displacement can.
 - (2) The volume of the stone is equal to the volume of the water in the displacement can.
 - (3) The mass of the stone is equal to the mass of the water collected in the beaker.
 - (4) The volume of the stone is equal to the volume of the water collected in the beaker.
9. Mandy was unable to separate the two metal cups shown.



Which of the following will allow Mandy to separate the two metal cups most easily?

- | | |
|---|---|
| X | Put some ice cubes into Cup B. |
| Y | Immerse Cup A into a basin of hot water. |
| Z | Place both cups in a basin of warm water. |
- (1) X only
 - (2) Z only
 - (3) X and Y only
 - (4) X and Z only

10. The flow chart shows the characteristics of objects W, X and Y.

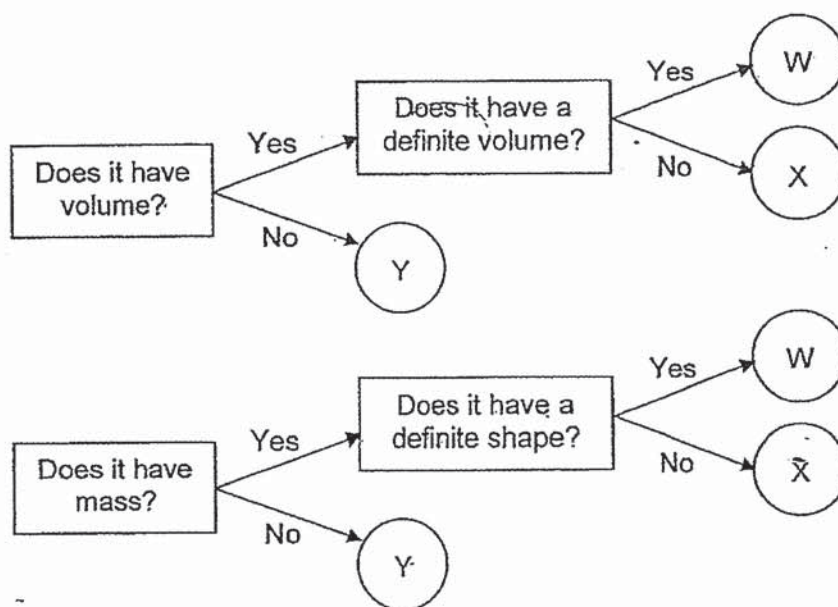

Which of the following are objects W, X and Y?

	Object W	Object X	Object Y
(1)	milk	oxygen	reflection
(2)	sand	carbon dioxide	shadow
(3)	sand	milk	carbon dioxide
(4)	wood	milk	oxygen

11. Larry placed a toy car on a piece of cardboard. He held a magnet under the cardboard. He observed that he could move the toy car by moving the magnet as shown below.

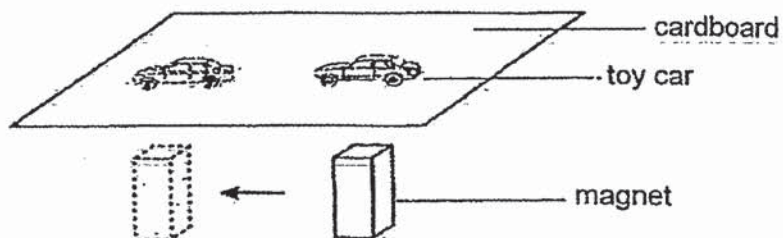

Based on his observations, he concluded that _____.

- (1) unlike poles of magnets attract
 - (2) a magnet is strongest at its poles
 - (3) cardboard is made of a magnetic material
 - (4) the toy car is made of a magnetic material
12. Jane stroked four metal bars, A, B, C and D, using a magnet. She stroked each of them 20 times. She then hung them next to one another. She observed that only one of the bars remained stationary while the rest either swung away from or towards one another as shown in the diagram.

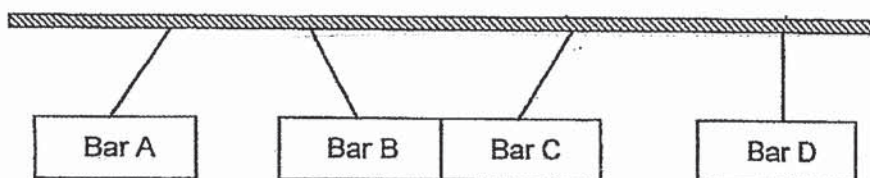

Which one of the following shows the most likely materials that bars A, B, C and D are made of?

	Bar A	Bar B	Bar C	Bar D
(1)	Iron	Silver	Steel	Copper
(2)	Iron	Steel	Iron	Copper
(3)	Steel	Silver	Steel	Iron
(4)	Copper	Iron	Silver	Iron

13. Timmy arranged three bar magnets AB, CD and EF in a straight line.

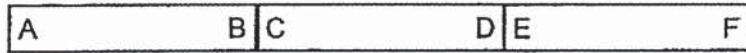

He rearranged them in another possible arrangement. Which one of the following is his arrangement?

(1)	<table border="1" style="margin: auto; text-align: center; border-collapse: collapse;"> <tr><td style="width: 50%;">A</td><td style="width: 50%;">B</td></tr> <tr><td>C</td><td>D</td></tr> <tr><td>E</td><td>F</td></tr> </table>	A	B	C	D	E	F										
A	B																
C	D																
E	F																
(2)	<table style="margin: auto; text-align: center;"> <tr><td colspan="2"></td><td style="border: 1px solid black; padding: 2px;">C</td><td colspan="2"></td><td style="border: 1px solid black; padding: 2px;">D</td><td colspan="2"></td></tr> <tr><td style="border: 1px solid black; padding: 2px;">B</td><td colspan="2" style="border: 1px solid black; padding: 2px;">A</td><td colspan="2"></td><td style="border: 1px solid black; padding: 2px;">E</td><td colspan="2" style="border: 1px solid black; padding: 2px;">F</td></tr> </table>			C			D			B	A				E	F	
		C			D												
B	A				E	F											
(3)	<table border="1" style="margin: auto; text-align: center; border-collapse: collapse;"> <tr><td style="width: 50%;">F</td><td style="width: 50%;">E</td></tr> <tr><td>C</td><td>D</td></tr> <tr><td>B</td><td>A</td></tr> </table>	F	E	C	D	B	A										
F	E																
C	D																
B	A																
(4)	<table style="margin: auto; text-align: center;"> <tr><td style="border: 1px solid black; padding: 2px;">B</td><td colspan="2" style="border: 1px solid black; padding: 2px;">A</td><td colspan="2"></td><td style="border: 1px solid black; padding: 2px;">C</td><td colspan="2" style="border: 1px solid black; padding: 2px;">D</td></tr> <tr><td colspan="2"></td><td style="border: 1px solid black; padding: 2px;">F</td><td colspan="2"></td><td style="border: 1px solid black; padding: 2px;">E</td><td colspan="2"></td></tr> </table>	B	A				C	D				F			E		
B	A				C	D											
		F			E												

14. Ali took three identical steel rods, P, Q and R and used different methods to make them into magnets. The diagrams show the methods he used.

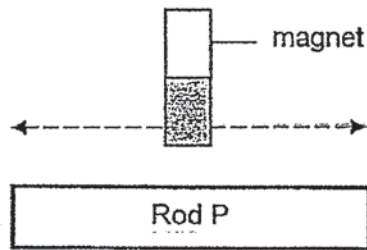

Method 1 : Stroking it to and fro with a magnet

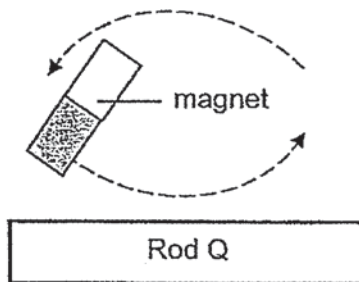

Method 2 : Stroking it in a circular movement with a magnet

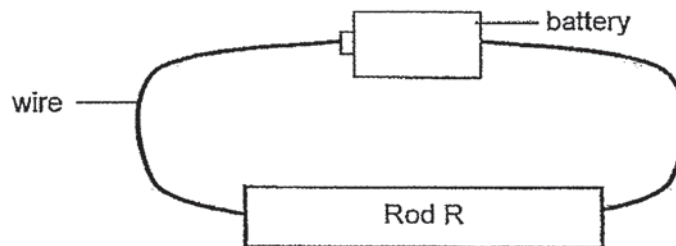

Method 3 : Connecting it to an electrical circuit

Which rod(s) would become a magnet/magnets?

- (1) P only
- (2) Q only
- (3) P and R only
- (4) Q and R only

15. Study the mind map of the systems in the human body and identify the systems represented by V and Z.

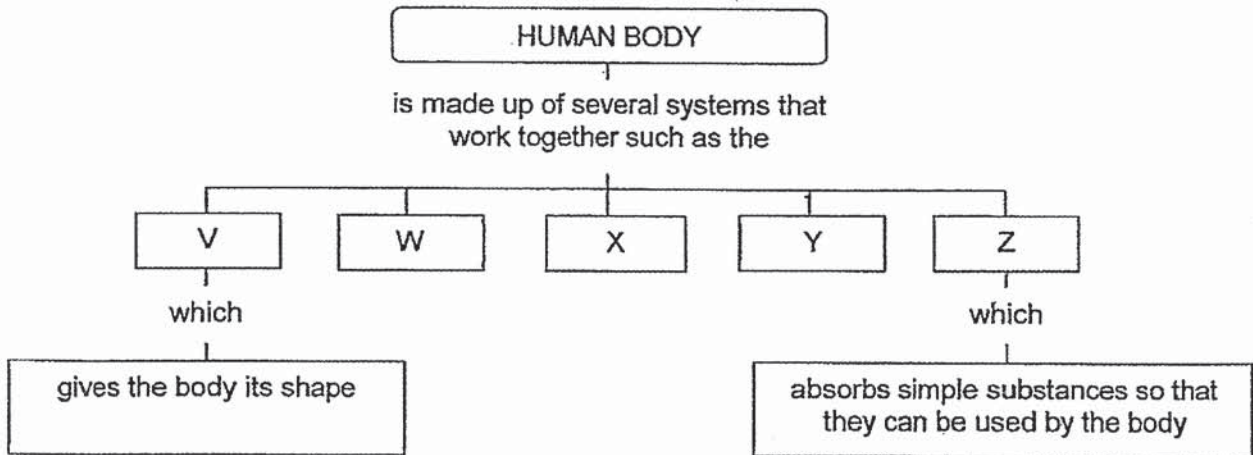

	V	Z
(1)	Skeletal system	Digestive system
(2)	Skeletal system	Respiratory system
(3)	Circulatory system	Muscular system
(4)	Muscular system	Circulatory system

16. The graph shows how the length of Daisy's shadow changes over a period of time as she walks in a straight line near a street lamp at night.

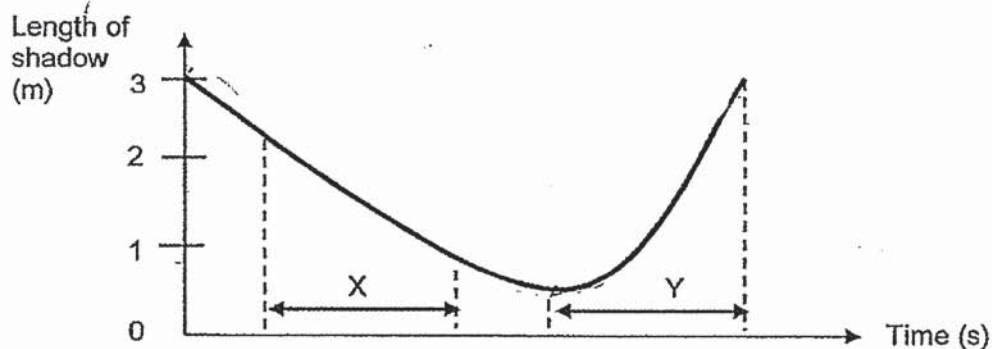

Based on the graph, which of the following conclusions are possible?

- A Daisy is walking towards the lamp during period X.
- B Daisy is walking towards the lamp during period Y.
- C Daisy is walking faster during period X than period Y.
- D Daisy is walking faster during period Y than period X.

- (1) A and C only
- (2) B and C only
- (3) A and D only
- (4) B and D only

17. Peter carried out an experiment to compare the transparency of materials P, Q and R.

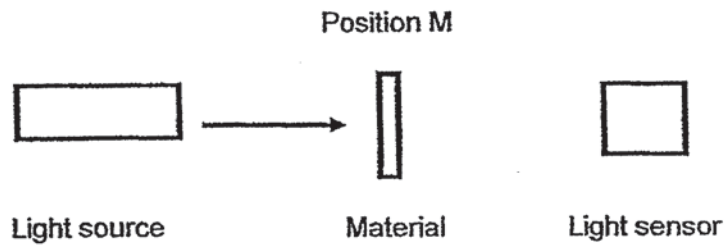

He used different materials, P, Q and R of the same thickness. For each material, he recorded the readings on the light sensor every time he added a piece of the material at position M. He stopped the recording when the light sensor could not detect any light. Peter then presented his findings in the graph shown.

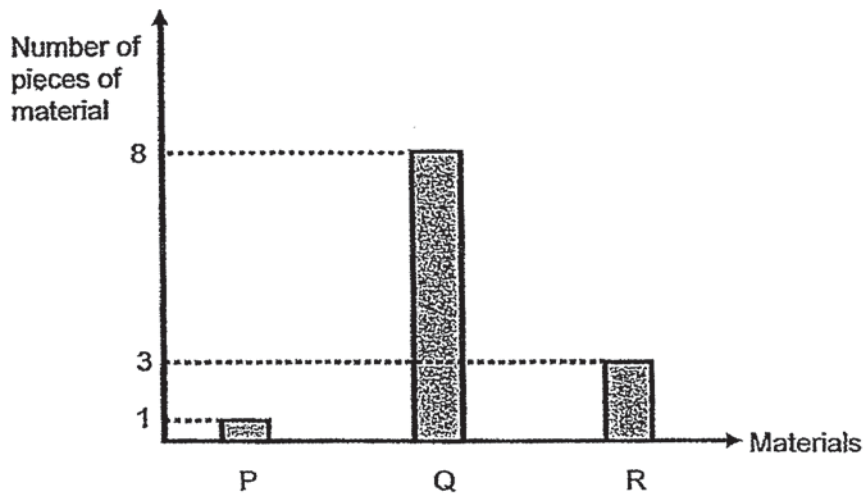

Arrange the materials from the one that allowed the most light to pass through to the one that allowed the least

- (1) Q , R , P
- (2) P , R , Q
- (3) P , Q , R
- (4) R , P , Q

18. Megan placed a different number of identical spoons into cups A and B and then filled both cups with the same amount of hot water at 80°C as shown.

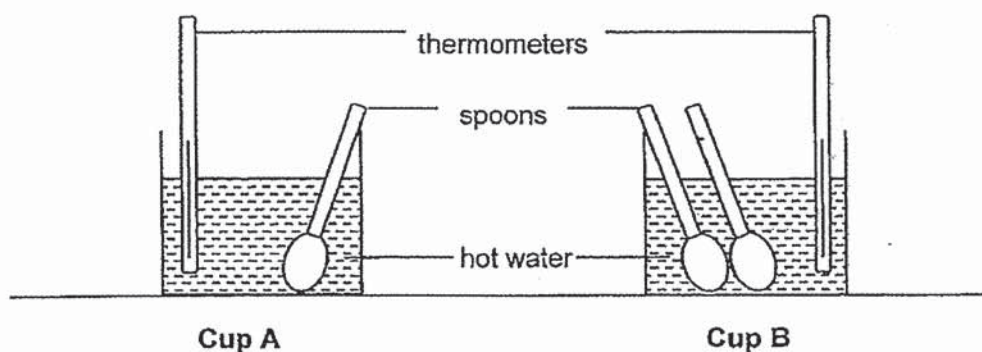

She observed that the temperature of water in one cup decreased quicker than the other cup. The water in both cups eventually reached the same temperature after some time.

Which one of the following statements is correct for Megan's experiment?

- A The water in both cups gained heat from the surrounding air.
 - B The temperature of the water in cup A decreased quicker than in cup B.
 - C Two spoons conducted heat from the hot water to the surrounding air quicker than one spoon.
 - D The water in cup B reached the same temperature as the surrounding air in a shorter period of time than in cup A.
- (1) A and B only
- (2) B and C only
- (3) C and D only
- (4) A, C and D only

19. The table shows the composition of atmospheric air.

Composition of Atmospheric Air (%)				
Oxygen	Carbon dioxide	Water vapour	Nitrogen	Other gases
21	0.04	0.5	78	0.46

Which of the following most likely shows the composition of exhaled air when a person is doing a vigorous exercise?

Composition of Exhaled Air (%)					
	Oxygen	Carbon dioxide	Water vapour	Nitrogen	Other gases
(1)	16	5	0.8	78	0.2
(2)	0	21	0.8	78	0.2
(3)	16	8	0.5	75	0.5
(4)	16	5	0.5	78	0.5

20. Study the diagram carefully. Arrows P and Q in the diagram represent the transportation of food and water from one part of the plant to another. E and F represent different parts of the plant.

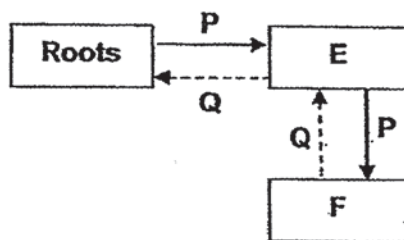

Which one of the following correctly represents E and F and arrows P and Q?

	E	F	P	Q
(1)	Stem	Leaf	Water	Food
(2)	Stem	Leaf	Food	Water
(3)	Leaf	Stem	Water	Food
(4)	Leaf	Stem	Food	Water

21. Daniel took part in a triathlon. The graph shows his heart rate (number of heart beats per minute) over a period of an hour) during the activity.

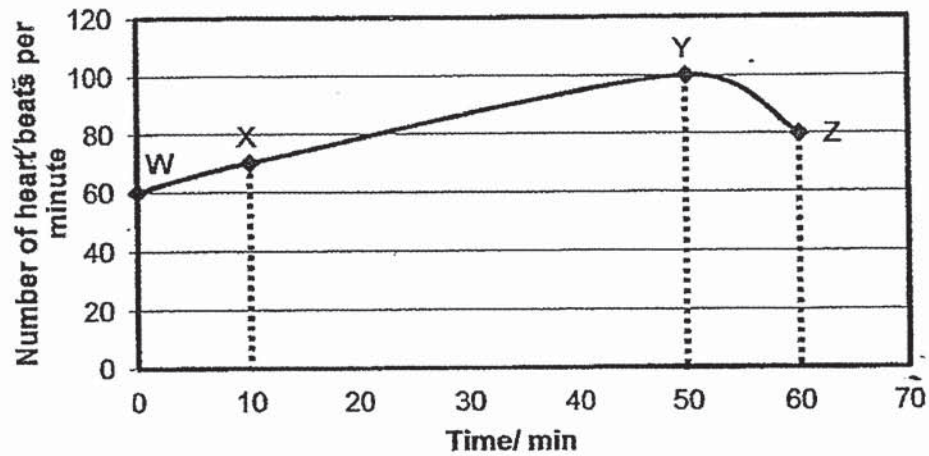

Which one of the following statement(s) can be inferred from the line XY on the graph?

- A Respiration occurs at a faster rate.
- B More carbon dioxide is produced by Daniel's body.
- C Daniel's heart is pumping blood to his lungs at a faster rate.
- D More blood is produced to supply more oxygen and nutrients to his muscles.

- (1) A only.
- (2) B and D only.
- (3) A, B and C only.
- (4) All of the above.

22. The diagram shows how blood is circulated in our body.

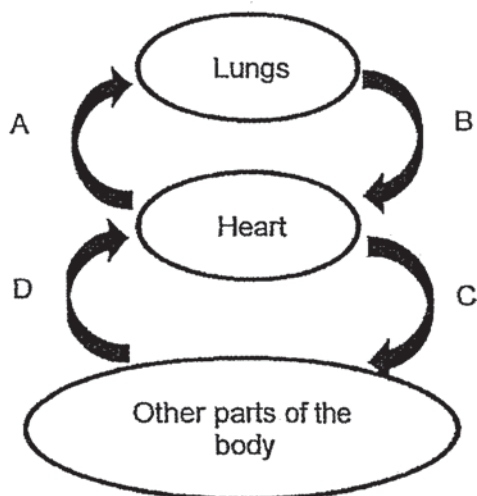

Which one of the following correctly shows the amount of oxygen in our blood at A, B, C and D?

	More oxygen at	Less oxygen at
(1)	A and B	C and D
(2)	A and D	B and C
(3)	B and C	A and D
(4)	B and D	A and C

23. Jane drew the cell shown below. She discovered that a part of the cell was missing.



Which one of the following functions is the cell unable to perform?

- (1) It cannot keep the shape of the cell.
- (2) It cannot control all activities of the cell.
- (3) It cannot trap light energy to make food.
- (4) It cannot allow substances to move freely within the cell.

24. Larry removed the food-carrying tubes of a plant by making a cut around the stem as shown.

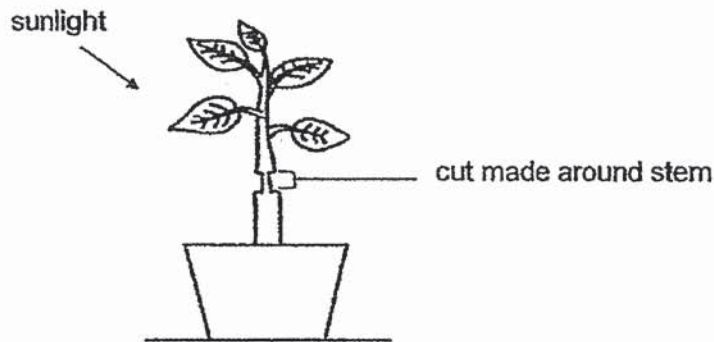

He left the plant under the Sun and watered it regularly. He observed that a part of the stem was swollen after several days.

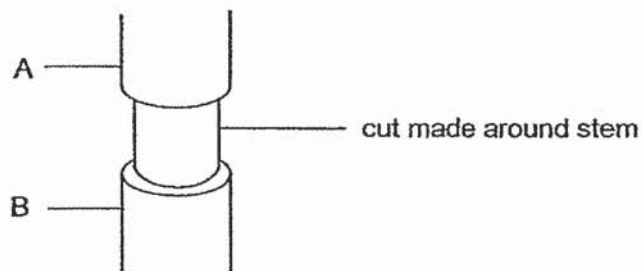

Which one of the following correctly shows the part of the stem, A or B, that was swollen and the reason for the swell?

	Swollen part of stem	Reason why stem was swollen
(1)	A	Water absorbed by the roots had travelled upwards and collected at A.
(2)	A	Food made by the leaves was unable to travel downwards and collected at A.
(3)	B	Water absorbed by the roots was unable to travel upwards and collected at B.
(4)	B	Food made by the leaves was unable to travel upwards and collected at B.

25. Rachel set up two closed circuits to find out if the number of batteries affect the brightness of the bulb.

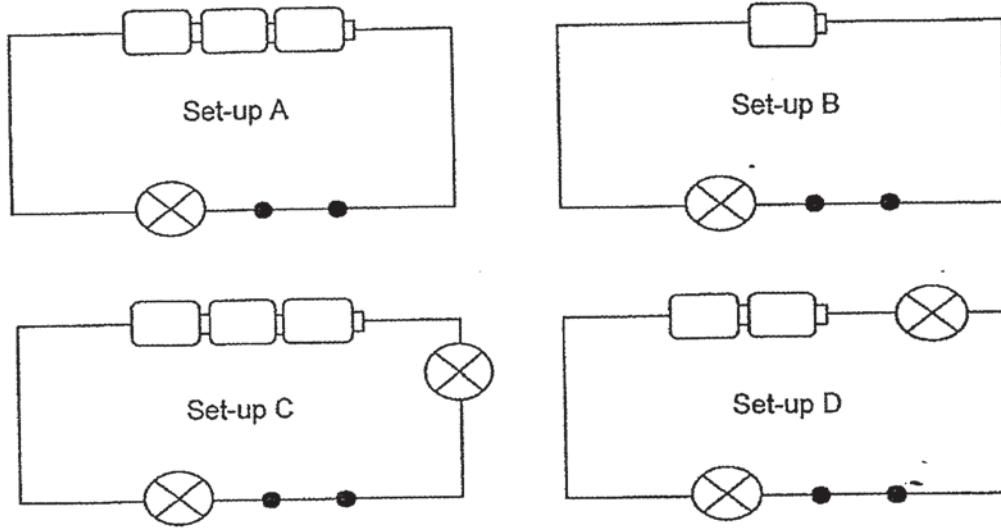

Which of the following two setups should she use for her experiment?

- (1) A and C
- (2) A and D
- (3) B and C
- (4) C and D

26. Which of the three switches in the circuit shown should be closed so that only bulb P lights up?

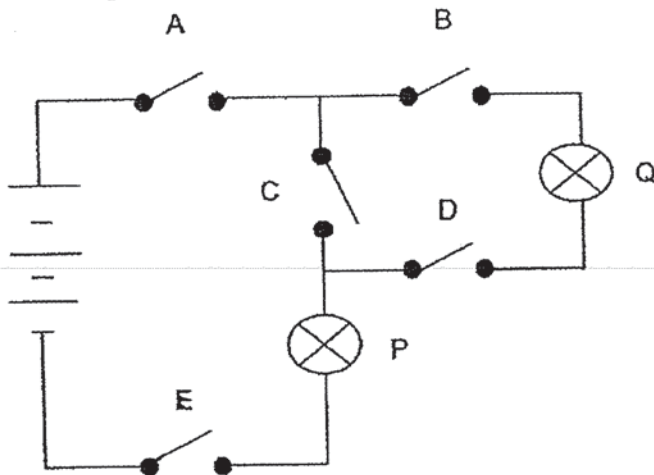

- (1) C, D and E
- (2) A, C and D
- (3) A, C and E
- (4) A, B and E

27. Study the circuit carefully.

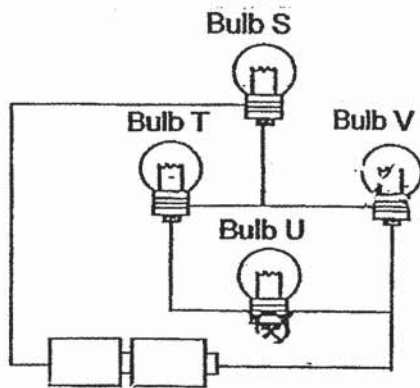

Which bulbs will light up if bulb V is fused?

- (1) Bulb S and T only
 - (2) Bulb S and U only
 - (3) Bulb S, T and U only
 - (4) None of the bulbs
28. Study the circuit diagram carefully. Materials V, W and X were connected to the circuit below.

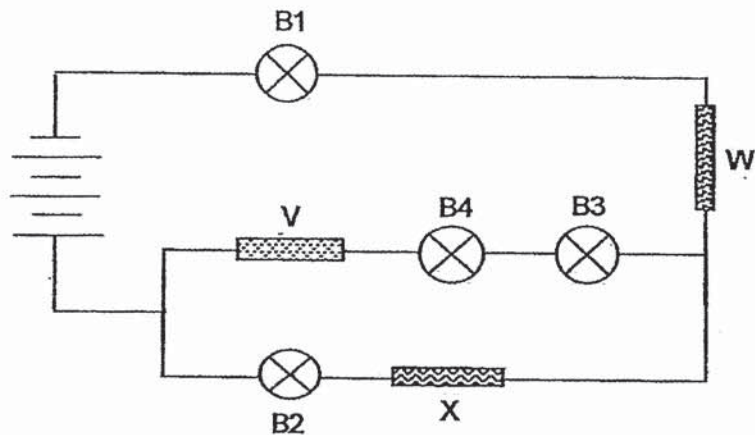

Which one of the following shows the correct bulbs that lit up when V, W and X are made of the stated materials?

Bulbs that light up

	V	W	X	Bulbs that light up
(1)	Iron	Plastic	Aluminium	B2, B3, B4
(2)	Aluminium	Steel	Plastic	B3, B4
(3)	Plastic	Gold	Steel	B1, B2
(4)	Nickel	Iron	Plastic	B1, B2, B3, B4

End of Booklet A

Anglo-Chinese School (Junior)



SEMESTRAL ASSESSMENT 1 (2019)

PRIMARY 5

SCIENCE

BOOKLET B

Friday

17 May 2019

1 hr 45 min

Name: _____ () Class: 5. Parent's Signature: _____

INSTRUCTIONS TO PUPILS

- 1 Do not turn over the pages until you are told to do so.
- 2 Follow all instructions carefully.
- 3 There are 13 questions in this booklet.
- 4 Answer ALL questions.
- 5 The marks are given in the brackets [] at the end of each question or part question.

Booklet	Possible Marks	Marks Obtained
A	56	
B	44	
Total	100	

This question paper consists of 14 printed pages (inclusive of cover page).

Booklet B

For questions 29 to 41, write your answers in this booklet.

The number of marks available is shown in brackets [] at the end of each question or part question. [44 marks]

29. The diagram shows the human digestive system.

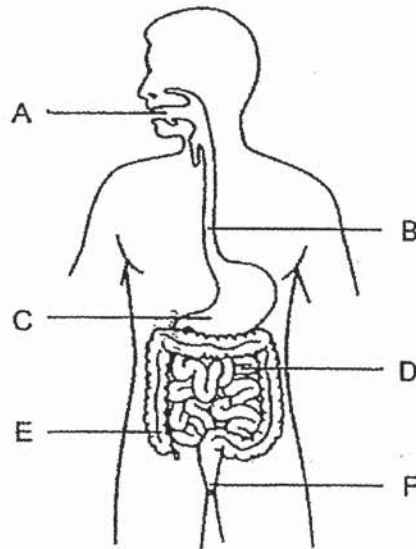

- (a) (i) In which part does digestion begin? _____ [½]
 (ii) In which part is water removed from undigested food? _____ [½]
- (b) Where is saliva present and how does it help in the digestive process? [1]
- _____
- _____
- (c) Explain how the completely digested food in the small intestine is able to provide the body with energy. [1]
- _____
- _____

(Go on to the next page)

SCORE	3
-------	---

30. The diagram shows the life cycle of a frog.

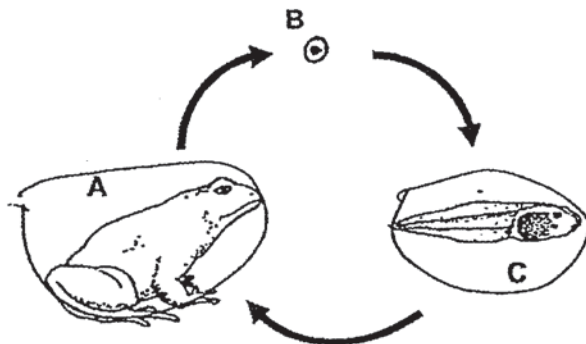

(a) Compare stage A and stage C. What is the difference in the way the animal takes in oxygen in the water? [1]

(b) In the space below, draw the life cycle of an insect with the same number of stages as a frog. Label and name the stages. (Do not draw the actual insect) [1]

(c) State a difference between the young of a frog and that of the insect you drew in (b). [1]

(Go on to the next page)

SCORE	3
-------	---

31. Samy carried out an investigation about matter using five objects, A, B, C, D and E of the same thickness, and placed them, two at a time, on a balance lever. The diagrams show his observations.

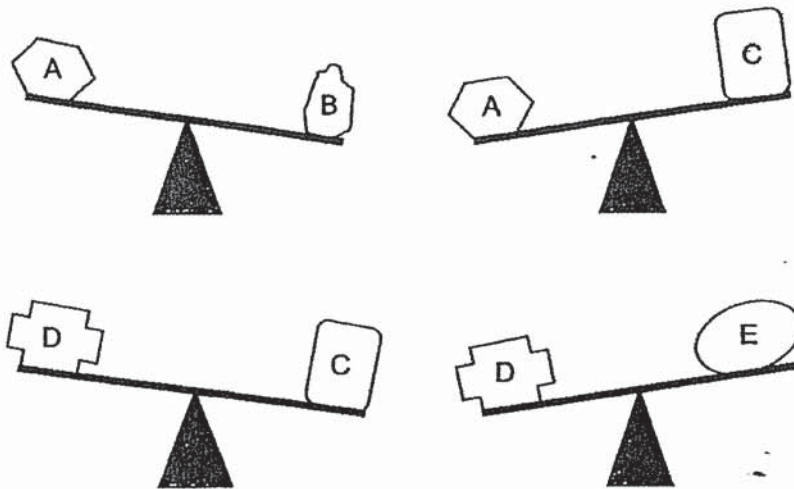

- (a) (i) Which object has the smallest mass? _____ [½]
 (ii) Which object has the greatest mass? _____ [½]

He took some of the objects and put them inside three beakers. He then poured in water until the water level in all the beakers was the same. The diagram shows what he observed.

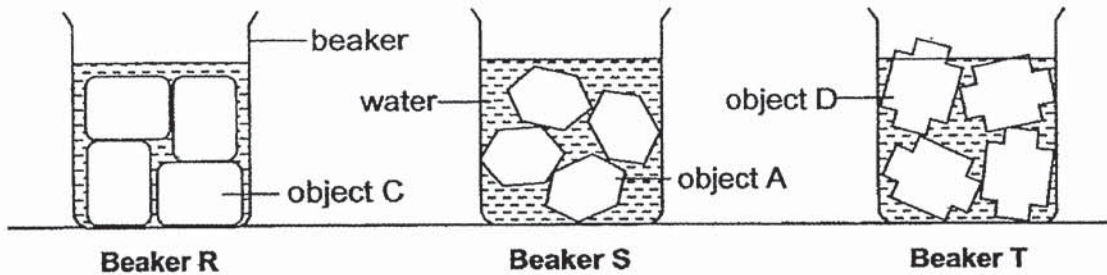

- (b) From his observations only, which one of the beakers, R, S or T, contained the least amount of water? Explain your answer. [1]

- (c) From his investigation, what property of matter can be observed in the water? [1]

(Go on to the next page)

SCORE	3
-------	---

32. Tom suspended four magnets, P, Q, R and S above a box of thumbtacks as shown in the diagram. All the magnets were placed an equal distance away from the thumbtacks.

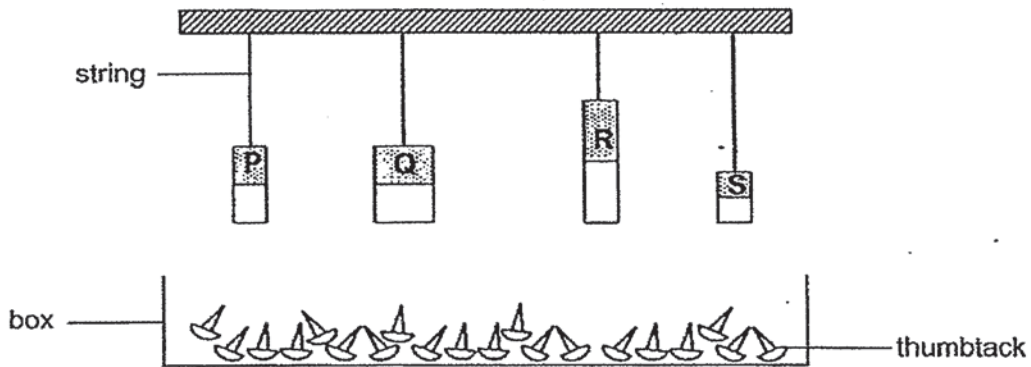

He observed the number of thumbtacks that each magnet was able to attract and recorded his findings in the table below.

Magnet	P	Q	R	S
Number of thumbtacks attracted	3	6	4	7

- (a) Based on his findings, list the magnets according to their magnetic strength, from the strongest to the weakest. [1]

- (b) What was the aim of his experiment? [1]

- (c) Tom replaced the thumbtacks with aluminium ring tabs. What would be the change in the results of his experiment? Explain your answer. [1]

(Go on to the next page)

SCORE	3
-------	---

33. Tom conducted an experiment with iron rod S and magnet T. The diagrams show what he observed.

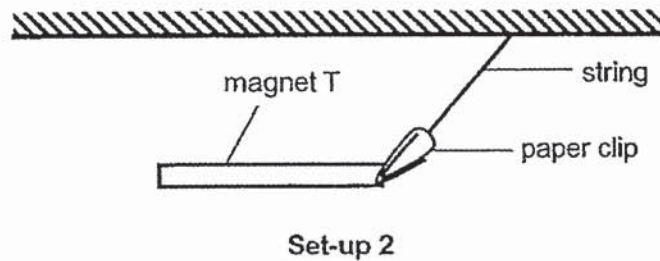
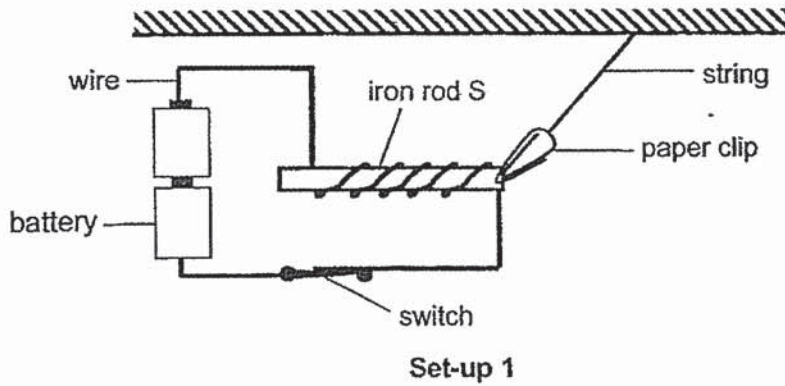

- (a) Tom opens the switch in set-up 1. What will happen to the paper clip? Explain your answer. [1]

- (b) What advantage does set-up 1 have over set-up 2 in attracting the paper clip?

- (c) Tom replaces the paper clip in set-up 1 with an iron ball that is 20 times the mass of the paper clip. Suggest two changes that he needs to make to set-up 1 to ensure that rod S will be able to attract the iron ball. [1]

(Go on to the next page)

SCORE	3
-------	---

34. The diagram shows five children in a playroom separated by four partitions, A, B, C and D. The partitions are made from different materials.

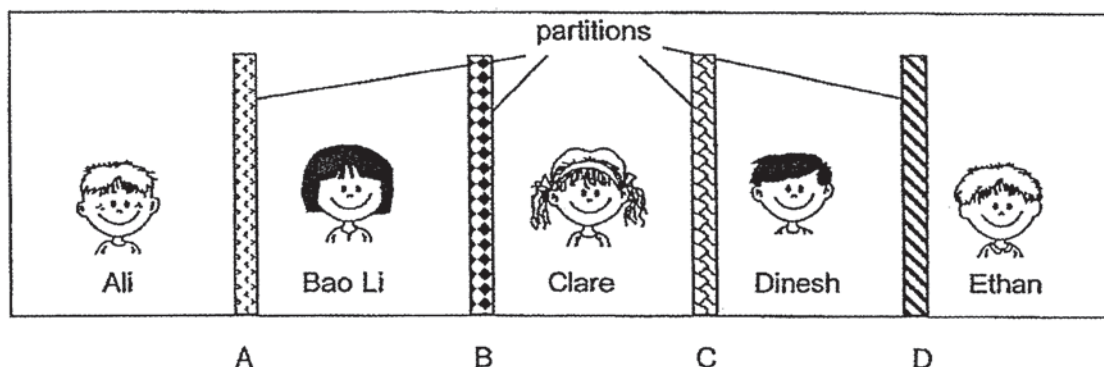

Ali and Clare recorded their observations as follows:

Ali : *I can see Bao Li but I cannot see the rest.*

Clare : *I can see Dinesh clearly but I am not sure who is next to him. I can make out the outline of the face but cannot see the details.*

- (a) What material is each of the partitions made of? Complete the table by writing in the letters A, B, C and D. [2]

Material	Partition
Wood	
Clear Glass	
Clear Plastic	
Frosted Glass	

- (b) The teacher wants to make the playroom safer for the children. She renovates it and replaces all the partitions with clear plastic. State two properties of clear plastic which make it safer for the children. [1]

- (c) The playroom has shelves made of plastic and wood to store books and supplies. Name another material that is commonly used to make such shelves. State the property of the material that makes it suitable. [1]

(Go on to the next page)

SCORE	
	4

35. Ravi wrapped three identical beakers with different materials, A, B and C. He then filled each beaker with 150 ml of water at 80°C and covered them with lids and placed them in his classroom as shown in the diagram.

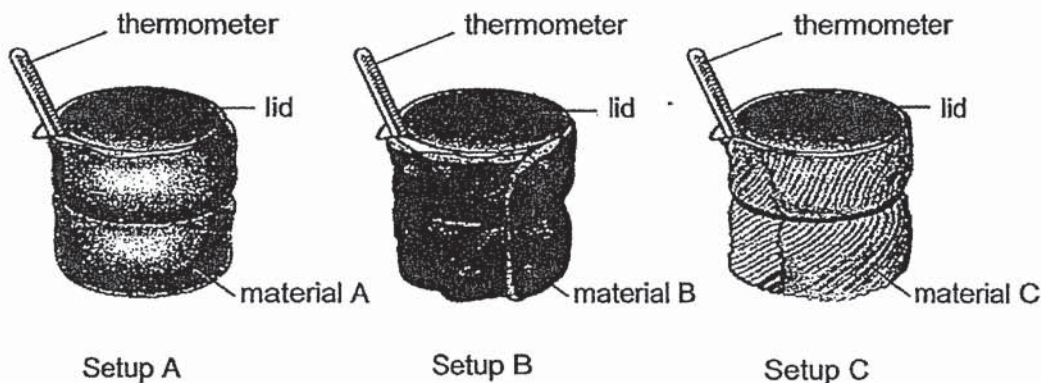

Ravi recorded the temperature of the thermometer over a period of time. His results are shown in the graph below.

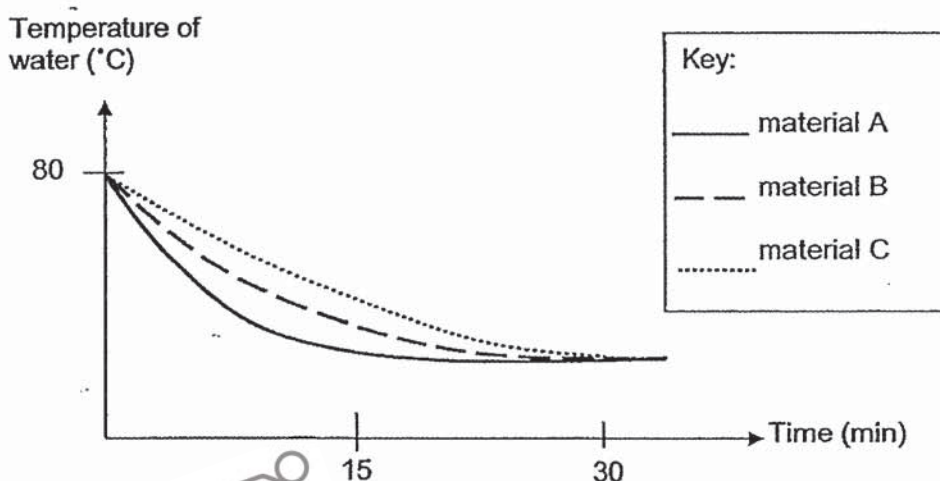

(a) Based on Ravi's results, which material, A, B or C, should he use to make a blanket to keep himself warm during the winter? Give a reason for your answer [2]

(Go on to the next page)

SCORE	2
-------	---

- (b) Name another variable that Ravi needs to keep the same for the three setups in order to ensure a fair experiment. [1]

- (c) Ravi observed that the temperature of the water in all the three beakers were the same after 45 minutes. Explain his observation. [1]

36. Albert wanted to find out how the amount of light reflected by each of the three materials, X, Y and Z is affected by the distance between the torch and the material. He carried out the experiment in a completely dark room using the set-up shown.

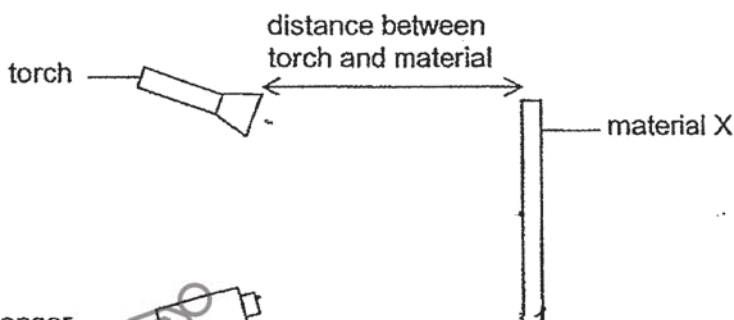

KIASU
ExamPaper
Islandwide Delivery | Whatsapp Only 88660031

- (a) Draw light rays in the above diagram to show how the light sensor detects light reflected by material X when the torch is switched on. [1]

(Go on to the next page)

SCORE	3
-------	---

Albert recorded the amount of light reflected by material X using a light sensor. Then he repeated the experiment with materials Y and Z, one at a time. The graph shows the results of Albert's experiment.

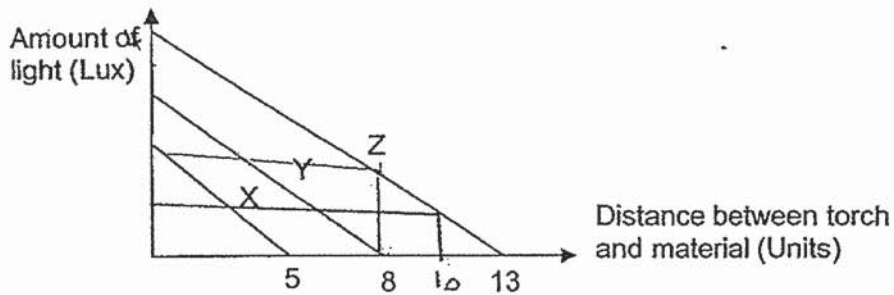

- (b) What is the relationship between the distance between the torch and the material and the amount of light reflected by the materials? [1]

- (c) Based on Albert's results, which material, X, Y or Z is best to be used to make a safety jacket for cyclist to wear at night so that motorist can spot him easily? [1]
Give a reason for your answer.

KIASU
ExamPaper
Islandwide Delivery | Whatsapp Only 88660031

(Go on to the next page)

SCORE	
	2

37. The diagrams show two different types of cells, X and Y.

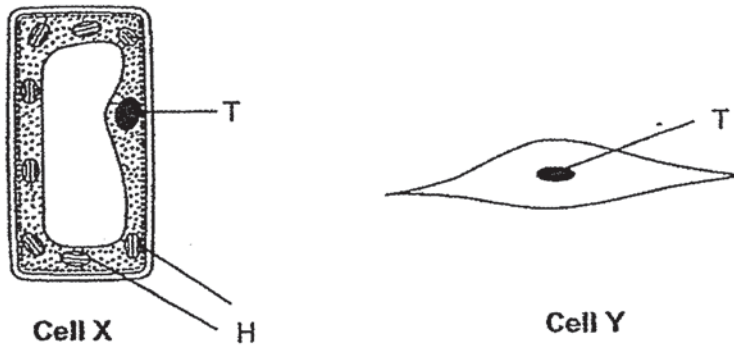

(a) Name and state the function of Parts T and H [3]

	Name	Function
Part T		
Part H		

(b) Which cell, X or Y, is most likely to be from a leaf of a hydrilla plant? Explain why. [1]

KIASU
ExamPaper
Islandwide Delivery | Whatsapp Only 88660031

(Go on to the next page)

SCORE	4
-------	---

38. The circuit card shown has a metal thumbtack at each of the points A, B, C, D and E. Some of the thumbtacks are connected by wires behind the card.

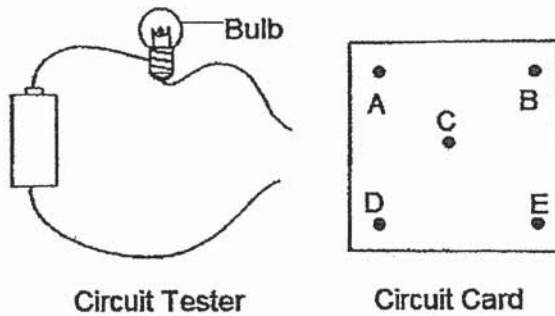

To find out how these thumbtacks are connected, the two ends of the circuit tester are connected to two different thumbtacks each time. The results are tabulated below.

Tester connected to thumbtacks at	Does the bulb light up?
A and D	No
B and D	No
B and C	Yes
C and E	Yes
A and C	No

- (a) Using **only two** wires, draw the arrangement of wires behind the circuit card below: [1]



- (b) Will the bulb in the circuit tester light up if it is connected to thumbtacks B and E? Explain your answer. [1]

(Go on to the next page)

SCORE	2
-------	---

39. Peter entered a "Design a Toy" competition and made a model of a railway track with trains. He wants a traffic light in which only 1 coloured light will light up at a time.



Traffic Light

- (a) Using 3 bulbs, 3 switches, 2 batteries and some wires, draw, using a pencil and ruler, a circuit diagram that allows it to work as a traffic light.

[2]

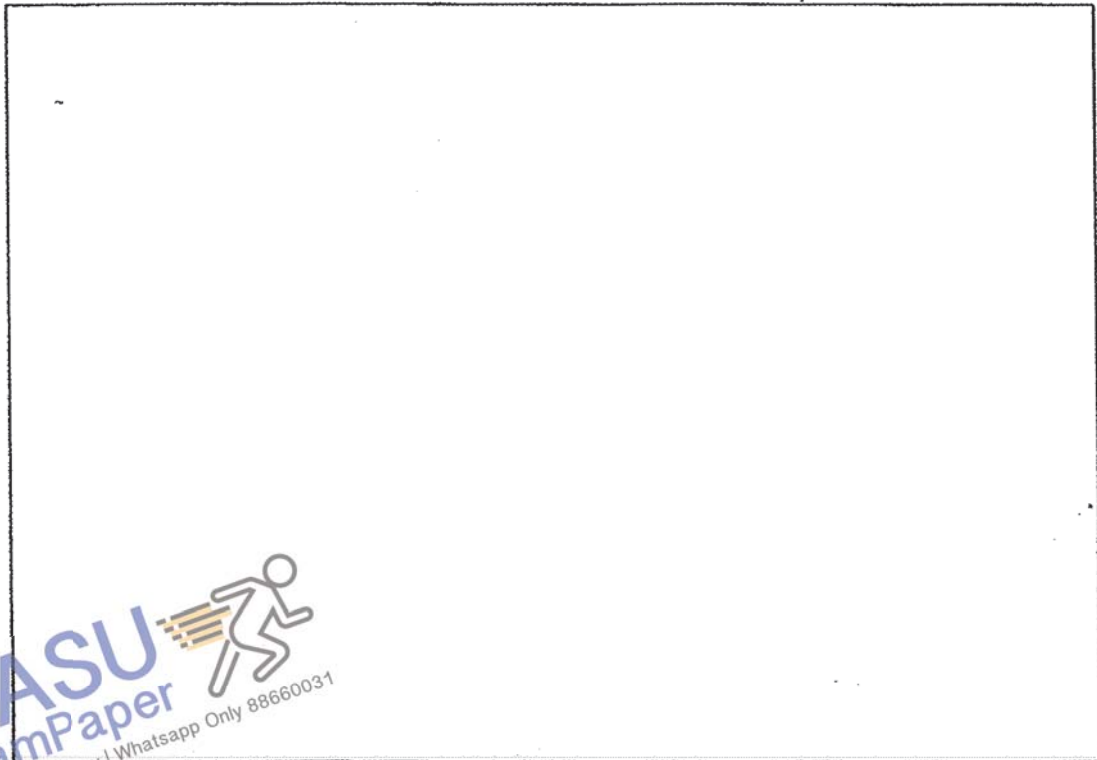

(Go on to the next page)

SCORE	
	2

Peter then set up the following electrical circuit to find out how Liquid A affects the brightness of the bulb.

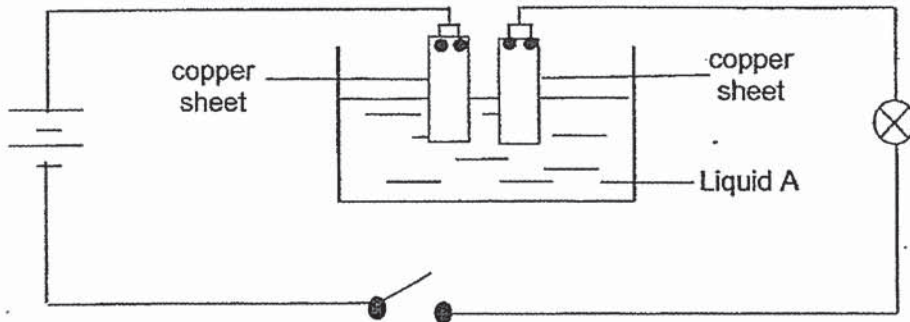

He repeated the experiment with the same set-up by replacing Liquid A with the same amount of Liquids B and C respectively. Peter recorded the brightness of the bulbs in the table.

Type of Liquid	Brightness of Bulb (units)
A	30
B	10
C	20

(b) Based on the results, rank the liquids based on how well they conduct electricity from the best conductor to the worst conductor. [1]

_____ → _____
 Best → Worst

(c) Why did Peter use the same amount of liquid A, B and C for his experiment to ensure that it is a fair test? [1]

KIASU ExamPaper
 Islandwide Delivery | Whatsapp Only 88660031

(d) What would Peter observe if he repeats the experiment with glass rods instead of copper sheets? Give a reason for his observation. [1]

(Go on to the next page)

SCORE	3
-------	---

40. The pictures show the plant transport system and the human circulatory system.

Plant transport system



Human circulatory system

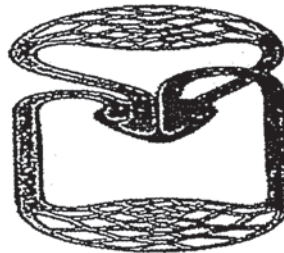

(a) Name two substances that are transported in the plant and human circulatory system. [1]

	Human	Plant
(i)		
(ii)		

(b) Besides those mentioned in (a), state one similarity between the plant and human circulatory system. [1]

The table shows how a boy's heart rate changes with the different activities he carried out.

Activities	Heart Beat (Beats / min)
At rest	68
Jogging	88
Running	108

KIASU
ExamPaper
Islandwide Delivery | Whatsapp: 88666031

(c) Explain why John's heart rate is faster when he was running? [2]

(Go on to the next page)

SCORE	4
-------	---

41. William placed Plant Y, with green leaves, in a flask filled with red-coloured water after cutting off its roots.

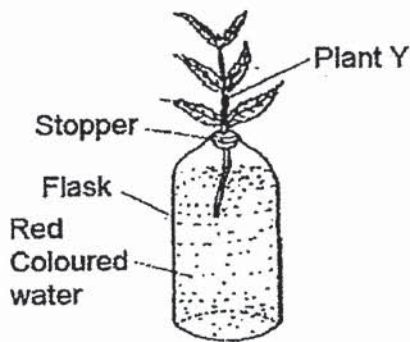

- (a) What will William observe about the leaves of Plant Y after a few days? Explain William's observations.

[2]

Ashton and Betty both made models of a plant stem for their Science lesson.

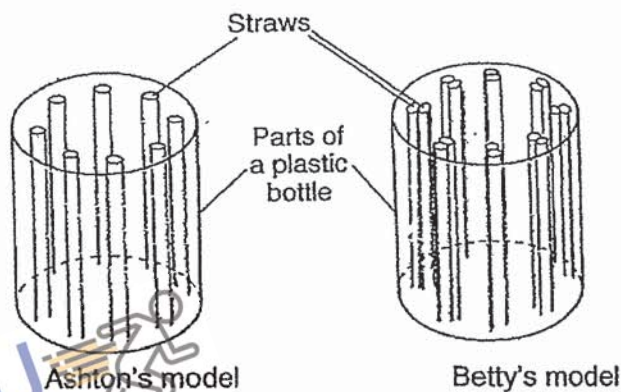

- (b) Whose model is a better representation of the plant transport system? Explain your choice. [1]

(Go on to the next page)

End Of Paper

SCORE	
	3



EXAM PAPER 2019

LEVEL : PRIMARY 5
SCHOOL : ANGLO-CHINESE SCHOOL (Junior)
SUBJECT : SCIENCE
TERM : SA1

SECTION A

Q1	Q2	Q3	Q4	Q5	Q6	Q7	Q8	Q9	Q10
1	3	2	4	2	3	3	4	3	2
Q11	Q12	Q13	Q14	Q15	Q16	Q17	Q18	Q19	Q20
4	2	3	2	1	3	1	3	1	1
Q21	Q22	Q23	Q24	Q25	Q26	Q27	Q28		
3	3	1	2	4	3	1	3		

BOOKLET B

- Q29. (a) (i) A
(ii) E
(b) In the mouth. It makes the food softer so that it is easy to swallow.
(c) The digested food will flow into the blood when it is absorbed through the Blood stream and into all parts of the body.

- Q30. (a) In stage A, the adult takes in oxygen through its moist skin in water but in stage C, the tadpole uses its gill.
(b)

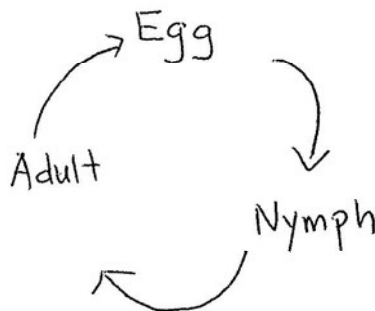

- (c) The insect's young resembles its adult while the frog's young does not resemble its adult.

- Q31. (a) (i) E (ii) B
 (b) Beaker R. Object C took up the most volume, because the gaps were the smallest compared to beaker S and T.
 (c) Water has no definite shape.
- Q32. (a) S, Q, R, P
 (b) He wants to find out is a magnet's strength is dependent on its size.
 (c) No ring tabs will be attracted. As aluminium is a non-magnetic material, the aluminium ring tabs will not be attracted by all magnets.
- Q33. (a) It will not be attracted as iron rod S could not be an electromagnet due to an Open circuit when the switch is open.
 (b) The magnetism can be controlled in iron rod S, but not in magnet T.
 (c) He can coil more wires on rod S and add one more battery to the set-up.
- Q34. (a) Wood : B
 Clear Glass : A
 Clear Plastic : C
 Frosted Glass : B
 (b) It will not break easily and it is more transparent.
 (c) Metal. It is strong and not flexible.
- Q35. (a) Material C. It kept the water the warmest before reaching room temperature because material C is the poorest conductor of heat.
 (b) The size of the material.
 (c) It has reached room temperature.

Q36. (a)

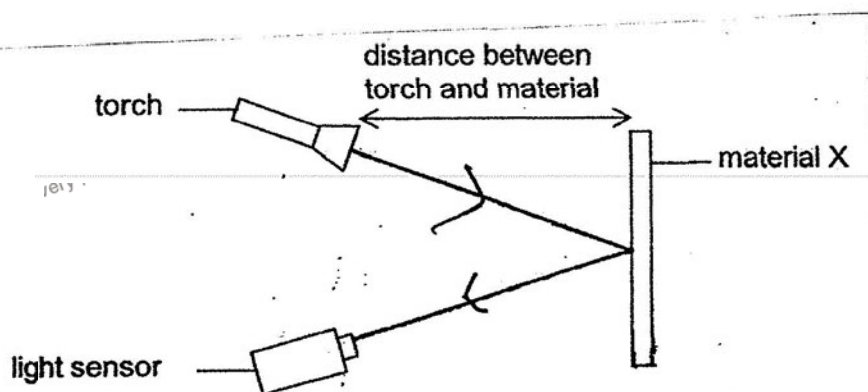

- Q36. (b) The greater the distance between the torch and the material, the lesser the amount light reflected by the material.
- (c) It reflects light at a further distance to shine at the motorist.

- Q37. (a) Nucleus : It controls all activities in the cell.
 Chloroplast : It contains chlorophyll which traps sunlight for the plant To photosynthesise.
- (b) Cell X. It has a cell wall and chloroplasts.

Q38. (a)

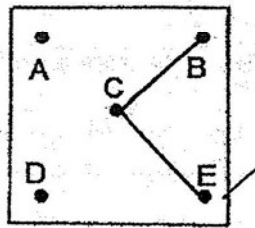

Circuit Card

- (b) Yes. It will form a closed circuit.

Q39. (a)

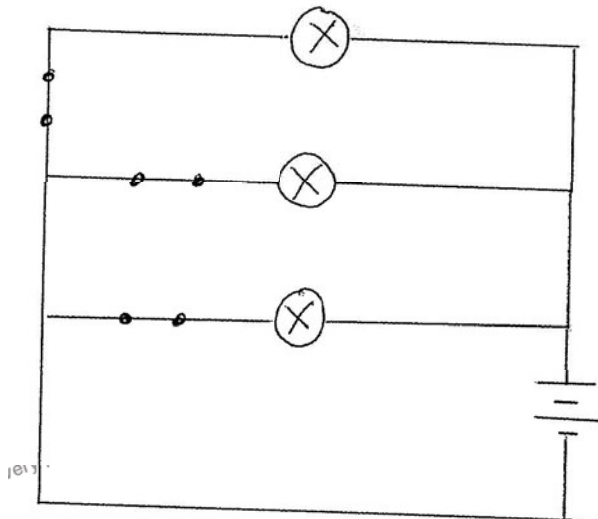

- (b) A C B
- (c) To ensure that it is a fair test and to test out the types of liquid easily.
- (d) The bulb will not light up as glass is an insulator of electricity.

Q40. (a)

Human	Plant
Blood	Water
Digested food	Food

- (b) Both transport substance to all parts of the organism.
(c) His heart has to beat faster to pump more blood rich in oxygen and digested Food to all other parts of the body for energy to be released.

- Q41. (a) The leaves will turn red. The stem in Y takes in the red-coloured water through the water carrying tube and transports it to all parts of the plant.
(b) Betty's model. There are 2 straws side by side representing the water and food Carrying tube while Ashton's model only has 1 straw representing 1 carrying Tube.