

Ai Tong School
P5 Mathematics
2022 Term 2 Review

Name: _____ () Date: _____

Class: 5 _____ Marks: _____ /35

Duration: 50 min Parent's signature: _____

Follow all instructions. Answer all questions.
You are allowed to use a calculator.

Section A

Questions 1 to 5 carry 2 marks each. Show your working clearly in the space provided for each question and write your answers in the spaces provided.
For questions which require units, give your answers in the units stated. (10 marks)

- 1 There are 28 blue marbles and 22 yellow marbles in a box. Find the ratio of the number of blue marbles to the total number of marbles in the box.
Give your answer in its simplest form.

Ans: _____

- 2 How many cubes are there in the solid shown below?

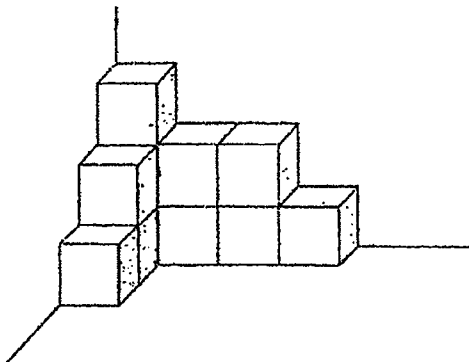

Ans: _____



3 Find the area of triangle ABC.

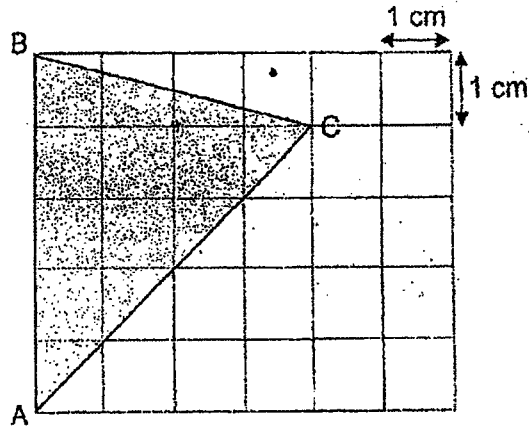

Ans: _____ cm²

4 Name a pair of base and height that can be used to find the area of triangle DEF.

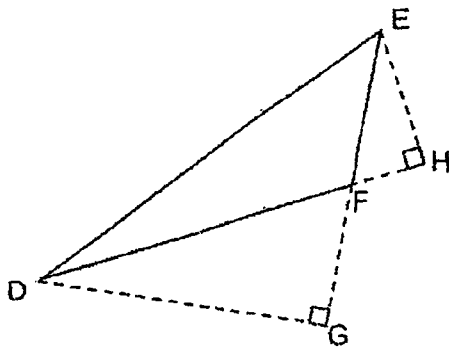

Ans: _____ and _____

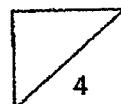

- 5 A cuboid has a height of 14 cm and a square base of 8 cm.
What is the volume of the cuboid?

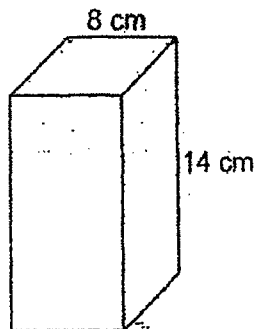

Ans: _____ cm^3

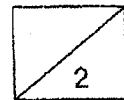

Section B

For questions 6 to 12, show your working clearly in the space provided for each question and write the answers in the spaces provided. The number of marks available is shown in the brackets [] at the end of each question or part-question. (25 marks)

- 6 Two pieces of wood, X and Y, are glued together as shown in the figure below. The ratio of the length of X to the length of Y is 3 : 5. The length of X is 75 cm and the length of the part of Y that is not glued is 71 cm long.

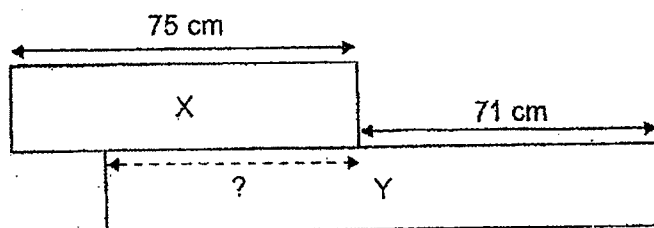

- (a) What is the length of Y?

Ans: (a) _____ [2]

- (b) What is the length of the part of X that is glued to Y?

Ans: (b) _____ [1]



- 7 The box shown below is 11 cm long, 10.5 cm wide and 4 cm tall. There are 4 cubes in the box. The volume of each cube is 1 cm^3 . John wants to fill the box with as many cubes as possible. How many more of such cubes can fit into the box?

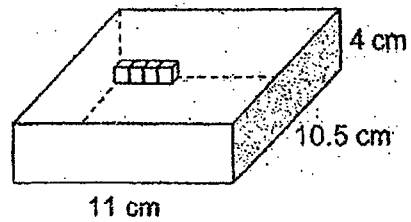

Ans: _____ [3]

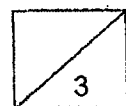

- 8 The figure $SXWU$ is made up of a rectangle and two triangles. STU is a straight line. $ST = 16$ cm and ST is twice as long as TU . $XS = TU$ and $WT = 19$ cm. Find the area of the figure.

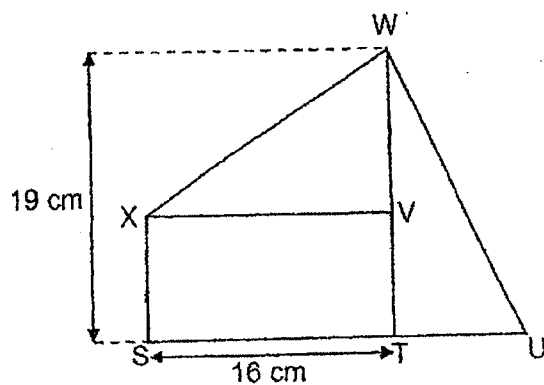

Ans: _____ [4]

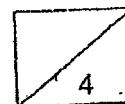

- 9 There were 120 000 spectators at a stadium. 91 200 were men. There were 4 times as many men as women. The remaining spectators were children. Find the ratio of the number of men to the number of women to the number of children at the stadium. Give your answer in its simplest form.

Ans: _____ [3]

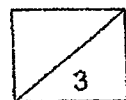

- 10 The figure below is made up of a rectangle JKLM and triangle PQR.
 $JK = 16\text{ cm}$, $KQ = QL$ and the total area of the shaded part is 216 cm^2 .
 Find the length of KQ.

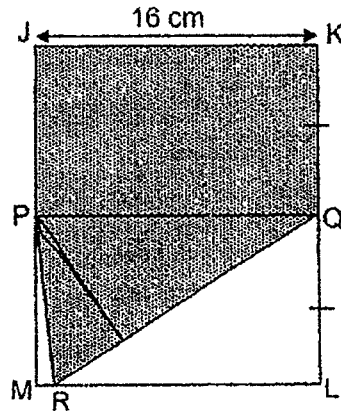

Ans: _____ [3]

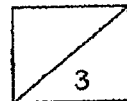

- 11 The figure below shows Triangle A overlapping Triangle B.
 The ratio of the area of Triangle A to the area of Triangle B is 8 : 5.
 The ratio of the shaded area to the area of Triangle B is 1 : 3.
 The area of Triangle A is 168 cm^2 .

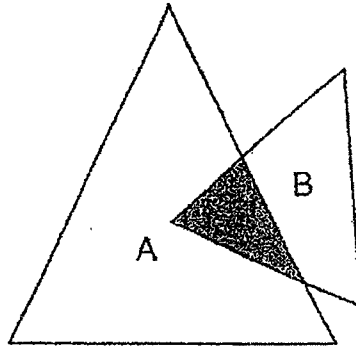

- (a) What is the area of Triangle B?

Ans: (a) _____ [2]

- (b) Find the ratio of the shaded area to the area of Triangle A.

Ans: (b) _____ [2]



- 12 A container measuring 50 cm by 30 cm by 40 cm was $\frac{5}{6}$ filled with water.
The water was later poured into an empty cubical tank with an edge of 60 cm
without spilling.

(a) What was the volume of the water in the container?

Ans: (a) _____ [2]

(b) How much more water was needed to fill the cubical tank completely?
Give your answer in litres.

Ans: (b) _____ [3]

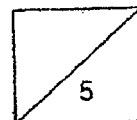

SCHOOL : AI TONG PRIMARY SCHOOL
 LEVEL : PRIMARY 5
 SUBJECT : MATHEMATICS
 TERM : 2022 TERM 2

Q1)	14 : 25
Q2)	11
Q3)	$\frac{1}{2} \times 5 \times 4 = 10\text{cm}^2$
Q4)	DF and EH
Q5)	$8 \times 8 \times 14 = 896\text{cm}^3$
Q6)	a) $75 \div 3 = 25$ $25 \times 5 = 125\text{cm}$ b) $125 - 71 = 54\text{cm}$
Q7)	$11 \times 10 \times 4 = 440$ $440 - 4 = 436$
Q8)	$16 \div 2 = 8$ $\frac{1}{2} \times 8 \times 19 = 76$ $19 - 8 = 11$ $\frac{1}{2} \times 16 \times 11 = 88$ $16 \times 8 = 128$ $76 + 88 + 128 = 292\text{cm}^2$
Q9)	$91200 \div 4 = 22800$ $22800 + 91200 = 114000$ $12000 - 114000 = 6000$ M : W : C 91200 : 22800 : 6000 912 : 228 : 60 152 : 38 : 10 76 : 19 : 5

Q10)	$216 \div 3 = 72$ $\frac{1}{2} \times 16 \times 9 = 72$ Ans : 9cm
Q11)	a) $168 \div 8 = 21$ $21 \times 5 = 105cm^2$ b) $105 \div 3 = 35$ S : A 35 : 167 5 : 24
Q12)	a) $50 \times 30 \times 40 = 60000$ $60000 \times \frac{5}{6} = 50000$ Ans : 50ℓ b) $60 \times 60 \times 60 = 216000$ $216 - 50 = 166ℓ$