



Established since 1930

RULANG PRIMARY SCHOOL

Nurturing Competencies, Inspiring Excellence; Empowering Individuals
Scholars of Tomorrow

Name : _____ ()

Total Marks
Paper 1

Level : Primary Five

Class : Primary 5

Date : 28 October 2022

Setters : Mdm Wahetha Begum and Ms Lim Yan Cheng

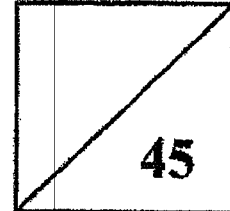

END OF YEAR EXAMINATION 2022 MATHEMATICS

PAPER 1 BOOKLET A

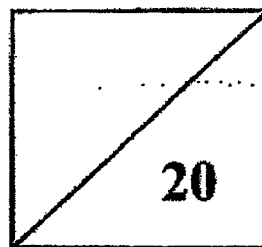

TOTAL TIME FOR PAPER 1 (BOOKLETS A & B): 1 hour
30 questions
45 marks

- DO NOT OPEN THIS BOOKLET UNTIL YOU ARE TOLD TO DO SO.
- READ ALL THE INSTRUCTIONS CAREFULLY.
- ANSWER ALL THE QUESTIONS.
- YOU ARE NOT ALLOWED TO USE A CALCULATOR.

Questions 1 to 10 carry 1 mark each. Questions 11 to 15 carry 2 marks each. For each question, four options are given. One of them is the correct answer. Make your choice (1, 2, 3 or 4) and shade your answer on the Optical Answer Sheet. (20 marks)

1. In 9 568 327, the value of the digit 6 is .

What is the missing number in the box above?

- (1) 60
- (2) 600
- (3) 6000
- (4) 60 000

2. Round 239 648 to the nearest thousand.

- (1) 240 000
- (2) 239 600
- (3) 239 000
- (4) 200 000

3. Find the value of $408 \div 6$.

- (1) 68
- (2) 408
- (3) 680
- (4) 4080

4. Express $\frac{3}{20}$ as a decimal.

- (1) 0.03
- (2) 0.15
- (3) 0.3
- (4) 1.5

5. $5.2 \div 100 =$.

What is the missing number in the box above?

- (1) 0.052
- (2) 0.52
- (3) 52
- (4) 520

6. In the figure below, ABC is an isosceles triangle. Find $\angle ABC$.

- (1) 58°
 (2) 61°
 (3) 64°
 (4) 122°

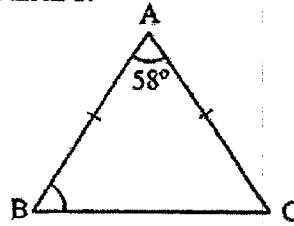

7. In the figure below, XYZ is a right-angled triangle. Find $\angle x$.

- (1) 55°
 (2) 70°
 (3) 125°
 (4) 145°

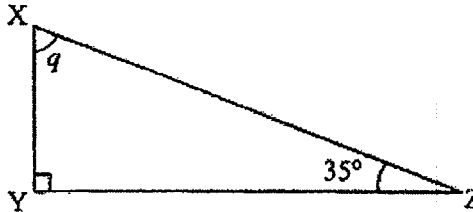

8. 4% of 20 =

What is the missing number in the box above?

- (1) 0.08
 (2) 0.8
 (3) 8
 (4) 80

9. Find the average of 0, 16, 34 and 34.

- (1) 84
 (2) 34
 (3) 28
 (4) 21

10. The average mass of 6 books is 18.36 kg. What is the total mass of the 6 books?

- (1) 3.06 kg
 (2) 3.6 kg
 (3) 108.16 kg
 (4) 110.16 kg

11. Bala bought two bags. The average cost of the two bags was \$360. One of the bags cost \$198. What was the cost of the other bag?

- (1) \$58
- (2) \$162
- (3) \$378
- (4) \$522

12. $\frac{3}{5} \times \frac{2}{9} = \boxed{\quad ? \quad}$

What is the missing fraction in the box above?

- (1) $\frac{1}{5}$
- (2) $\frac{2}{15}$
- (3) $\frac{2}{3}$
- (4) $\frac{5}{14}$

13. Find the value of $84 - 7 \times 8 + 28 \div 4$.

- (1) 21
- (2) 35
- (3) 161
- (4) 623

14. Mrs Tan had $\frac{4}{5}$ kg of flour. She used $\frac{3}{4}$ of it to bake cookies. How much flour did she have left?

- (1) $\frac{1}{20}$ kg
- (2) $\frac{1}{5}$ kg
- (3) $\frac{3}{5}$ kg
- (4) $\frac{1}{4}$ kg

15. In the figure below, JKLM is a trapezium, JKM is an isosceles triangle and IJK is a straight line. Find $\angle KLM$.

- (1) 50°
 (2) 87°
 (3) 90°
 (4) 93°

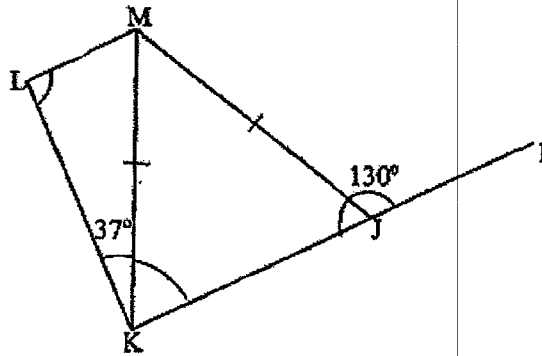

End of Paper 1 Booklet A



Established since 1930

RULANG PRIMARY SCHOOL

Nurturing Competencies, Inspiring Excellence, Empowering Individuals
Scholars of Tomorrow

Name : _____ ()

Level : Primary Five

Class : Primary 5 _____

Date : 28 October 2022

Setters : Mdm Wahetha Begum and Ms Lim Yan Cheng

END OF YEAR EXAMINATION

2022

MATHEMATICS

PAPER 1

BOOKLET B

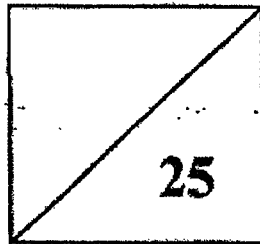

TOTAL TIME FOR PAPER 1 (BOOKLETS A & B): 1 hour
30 questions
45 marks

- **DO NOT OPEN THIS BOOKLET UNTIL YOU ARE TOLD TO DO SO.**
- **READ ALL THE INSTRUCTIONS CAREFULLY.**
- **ANSWER ALL THE QUESTIONS.**
- **YOU ARE NOT ALLOWED TO USE A CALCULATOR.**

Questions 16 to 20 carry 1 mark each. Write your answers in the spaces provided. For questions which require units, give your answers in the units stated. (5 marks)

16. Write five million, sixty-two thousand and eight in numerals.

Ans: _____

17. Multiply 947 by 300. What is the answer?

Ans: _____

18. What is 3006 g in kilogrammes? Express your answer as a decimal.

Ans: _____ kg

19. Mr Lee had a rope which was 4 m long. He cut it into 6 equal pieces. What was the length of each piece of rope? Express your answer as a fraction in its simplest form.

Ans: _____ m

20. In the figure below, PQR is a triangle and QRS is a straight line. Find $\angle m$.

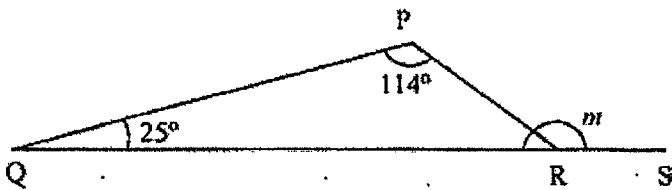

Ans: _____ $^\circ$

Questions 21 to 30 carry 2 marks each. Show your working clearly and write your answers in the spaces provided. For questions which require units, give your answers in the units stated.

(20 marks)

-
21. The ratio of John's mass to Mary's mass is 4 : 3. John's mass is 48 kg. What is Mary's mass?

Ans: _____ kg

-
22. Mrs Lee has 24 apples, 20 oranges and 26 pears. What is the ratio of number of oranges to the number of pears to the total number of fruits she has in its simplest form?

Ans: _____

-
23. Mr Tan had 300.5 kg of rice. He packed them equally into 50 _____ How much rice was there in each packet?

Ans: _____ kg

24. The length of a cuboid is 18 cm and its breadth is 9 cm. Its height is $\frac{1}{3}$ of its length.
What is the volume of the cuboid?

Ans: _____ cm^3

25. In the figure below, EFGH is a parallelogram. Find $\angle EFG$.

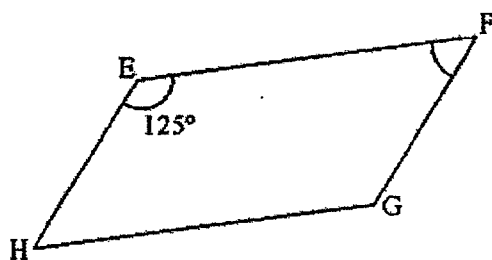

Ans: _____ $^\circ$

26. (a) Express $\frac{4}{5}$ as a percentage.
(b) Express 7.5% as a decimal.

Ans: (a) _____ %

(b) _____

27. Mr Yeo bought a laptop for \$3235. He paid \$1435 first and the remaining amount in monthly payments of \$300 each. How many months did he take to pay the remaining amount?

Ans: _____

28. Find the area of triangle ABC.

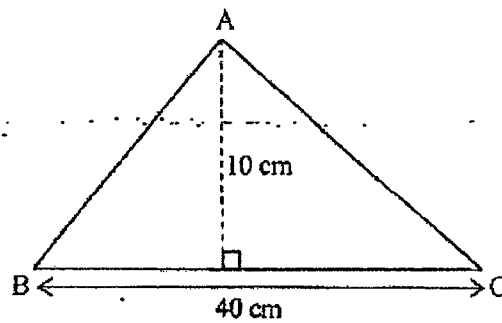

Ans: _____ cm^2

29. Find the area of triangle CEF.

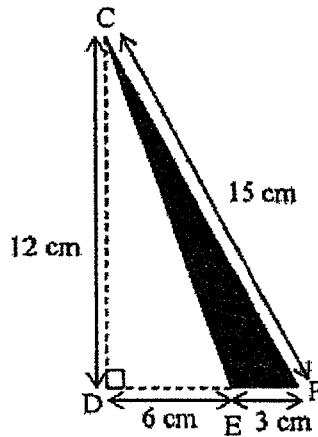

Ans: _____ cm^2

30. Mary and Lina had some stickers. After Lina and Mary each gave away 28 stickers, Lina had 3 times as many stickers as Mary.

Each statement below is either true, false or not possible to tell from the information given. For each statement, put a tick (\checkmark) in the correct column.

Statement	True	False	Not possible to tell
Lina had more stickers than Mary at first.			
Mary and Lina had 232 stickers in the end.			
Lina had 85 more stickers than Mary in the end.			

End of Paper 1



RULANG PRIMARY SCHOOL

Nurturing Competencies, Inspiring Excellence, Empowering Individuals
Scholars of Tomorrow

Established since 1930

Name : _____ () Total Marks
Papers 1 & 2

Level : Primary Five

Class : Primary 5 _____

Date : 28 October 2022

Setters : Mdm Wahetha Begum and Ms Lim Yan Cheng

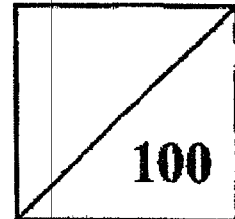

END OF YEAR EXAMINATION

2022

MATHEMATICS

PAPER 2

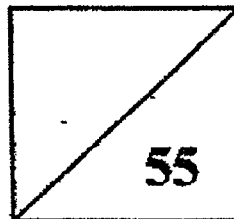

TOTAL TIME FOR PAPER 2: 1 hour 30 minutes

17 questions

55 marks

- **DO NOT OPEN THIS BOOKLET UNTIL YOU ARE TOLD TO DO SO.**
- **READ ALL THE INSTRUCTIONS CAREFULLY.**
- **ANSWER ALL THE QUESTIONS.**
- **YOU ARE ALLOWED TO USE A CALCULATOR.**

Questions 1 to 5 carry 2 marks each. Show your working clearly and write your answers in the spaces provided. For questions which require units, give your answers in the units stated.

(10 marks)

1. Mr Koh is 37 years old. His son is 4 years old. In how many years' time will Mr Koh be 4 times as old as his son?

Ans: _____

2. The mass of a box containing 30 similar books is 36.8 kg. The mass of an identical box containing 15 such books is 18.8 kg. What is the mass of a book?

Ans: _____ kg _____ g

3. The table below shows the amount of money saved by four children.

Name	Amount Saved
Anne	\$280
Betty	\$320
Calvin	\$304
Derek	?

The average amount of money the four children saved was \$295. How much did Derek save?

Ans: \$ _____

4. In the figure below, PQ is 3 times as long as XY. PQ is 21 cm long while QR is 14 cm long. Find the area of the shaded triangle XYR.

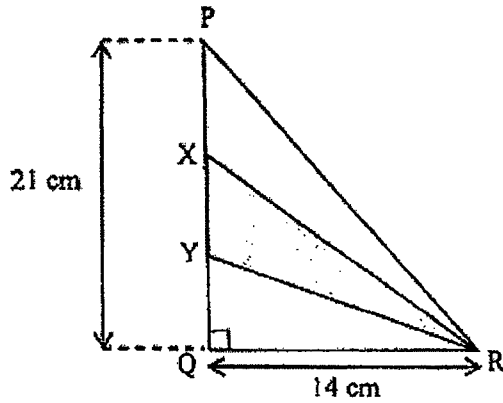

Ans: _____ cm^2

5. PQRS is a square of side 18 cm. The ratio of the length of PX to the length of XQ is 1:5. The length of XQ is equal to the length of XY. Find the area of the shaded triangle QXY.

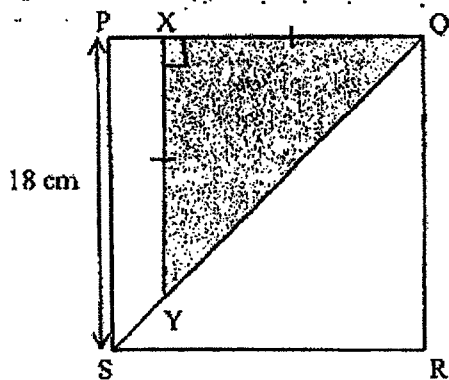

Ans: _____ cm^2

For Questions 6 to 17, show your working clearly and write your answers in the spaces provided. The number of marks available is shown in brackets [] at the end of each question or part-question. (45 marks)

6. The table below shows the ticket prices at a cinema.

Types of Tickets	Ticket Price (Weekdays)	Ticket Price (Weekends)
Adults	\$9 per ticket	\$14.50 per ticket
Children (12 years old and below)	\$7 per ticket	
Senior Citizens (60 years old and above)	\$4.50 per ticket	

Mr Ng wants to buy 2 adult tickets, 2 senior citizen tickets and 3 children tickets to watch a movie on a Tuesday evening. How much will he have to pay for all the tickets?

Ans: _____ [3]

7. Leo and Amelia had the same amount of money at first. After Leo spent $\frac{3}{4}$ of his money and Amelia spent $\frac{1}{3}$ of her money, Amelia had \$15 more than Leo. How much money did they have altogether at first?

Ans: _____ [3]

8. A rectangular tank measuring 40 cm by 30 cm was filled with water to a height of 18 cm. Jack poured some of the water from the tank into 3 identical pails until they are completely full. The height of the water in the tank then dropped to 5 cm.
- (a) Find the volume of water in the tank at first.
(b) Find the capacity of each pail.

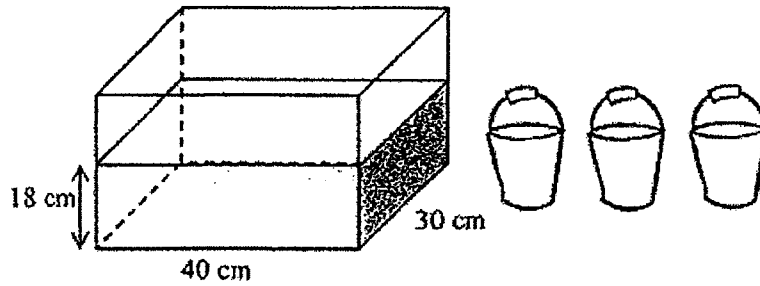

Ans: (a) _____ [1]

(b) _____ [2]

9. The solid below is built using 1-cm cubes.
 (a) What is the volume of the solid?

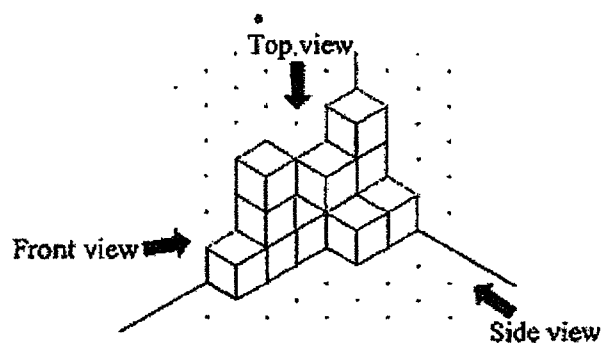

Ans: (a) _____ [1]

- (b) Draw the front and top views of the solid on the square grids below. [2]

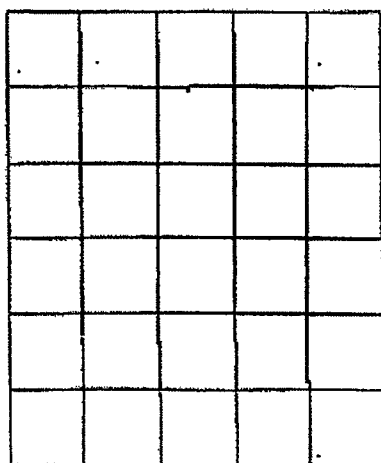

Front View

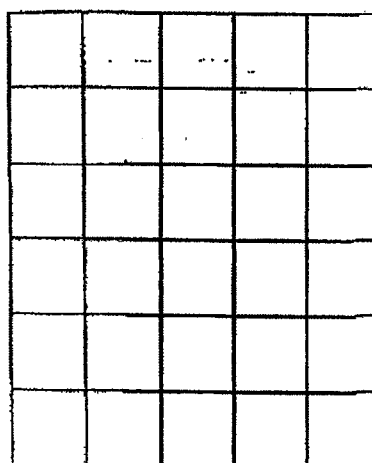

Top View

10. A rectangular piece of paper is folded as shown below.
 (a) Find $\angle x$.
 (b) Find $\angle y$.

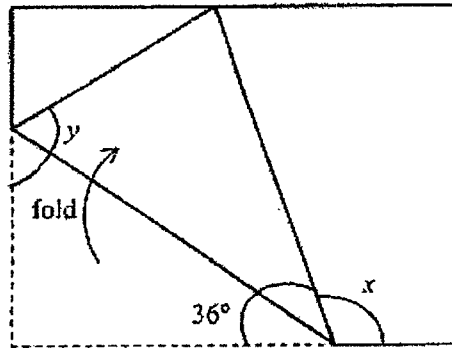

Ans: (a) _____ [2]

(b) _____ [1]

11. At a supermarket, 200 g of grapes cost \$4.50. Apples are sold at 5 for \$3.60. How much will 600 g of grapes and 30 apples cost altogether?

Ans: _____ [3]

12. A rectangular tank was partially filled with water at first. Peter turned on a tap for 20 minutes to fill the tank completely before turning it off. The line graph below shows the volume of water in the tank at 5-minute intervals up to 20 minutes.

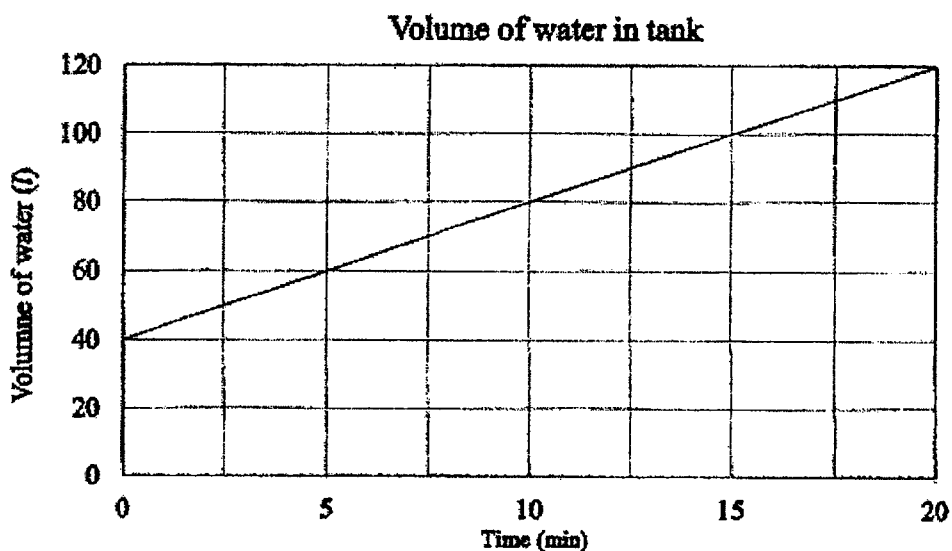

- (a) What was the rate of the flow of water from the tap in litres per minute?
- (b) What fraction of the tank was filled with water after Peter had turned on the tap for 14 minutes? Express your answer in its simplest form.

Ans: (a) _____ [1]

(b) _____ [3]

13. The table below shows the number of cupcakes sold by Mr Lim from Monday to Friday.

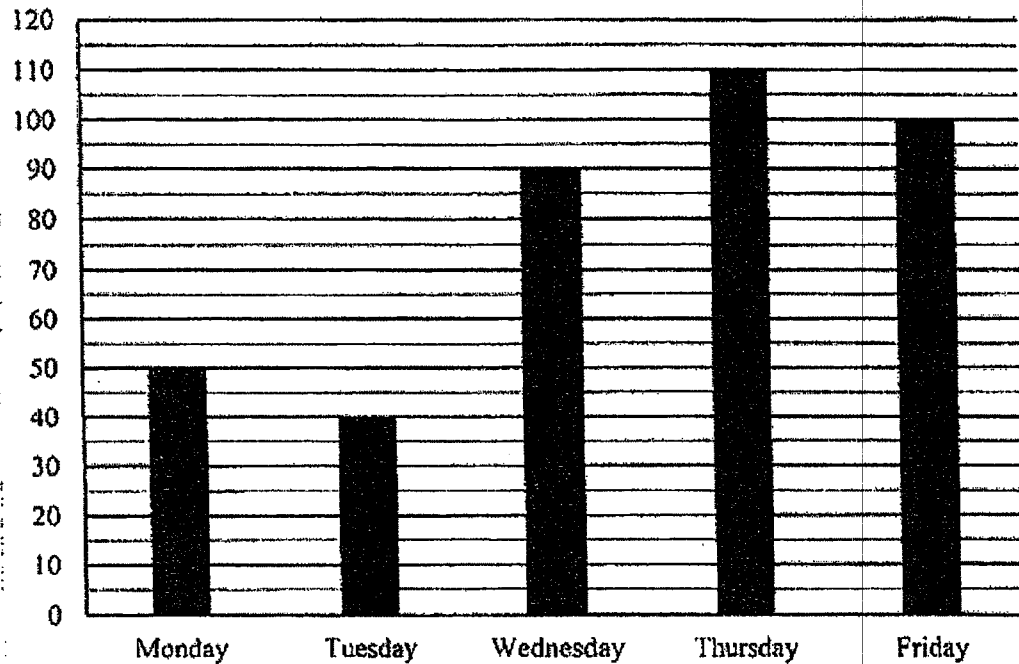

- (a) What was the average number of cupcakes sold by Mr Lim from Monday to Friday?
- (b) The average number of cupcakes Mr Lim sold from Monday to Sunday was 120 cupcakes. How many cupcakes did he sell altogether on Saturday and Sunday?

Ans: (a) _____ [2]

(b) _____ [2]

14. Mr Ahmad won \$8888 in a lucky draw. He gave 40% of it to his parents and 25% of it to his wife. He bought a laptop with the rest of the money.
- (a) How much money did he pay for the laptop?
 - (b) What was the difference in the amount of money given to his parents and the amount of money he paid for the laptop?

Ans: (a) _____ [2]

(b) _____ [2]

15. Karen spent \$10 on 2 exercise books and 8 pens. She wanted to buy another exercise book but was short of \$0.60. Instead, she bought 1 more pen and had \$0.40 left.
- (a) What was the cost of an exercise book?
- (b) How much money did Karen have at first?

Ans: (a) _____ [3]

(b) _____ [2]

6. The figure below shows two overlapping triangles, AEH and CIG. AEH is an isosceles triangle with $EA = EH$. $\angle AHE = 65^\circ$, $\angle DFE = 76^\circ$ and $\angle ICG = 42^\circ$.

(a) Find $\angle FDE$.

(b) Find $\angle IJH$.

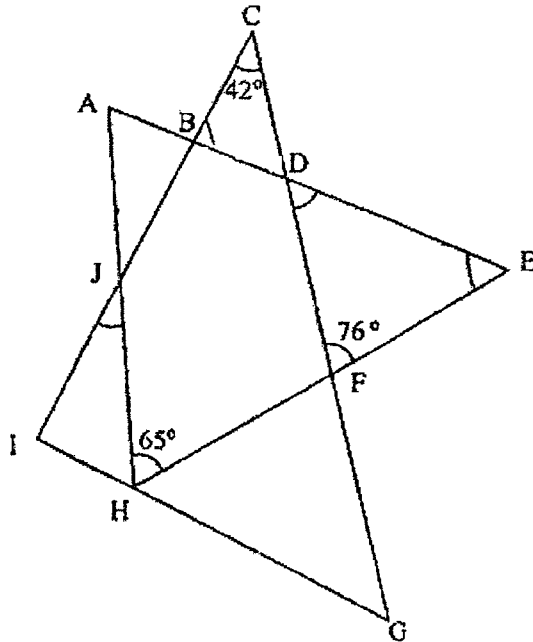

Ans : (a) _____ [3]

(b) _____ [2]

17. Kelly, Jennifer and Sarah donated some money to charity. Jennifer and Sarah donated $\frac{5}{9}$ of the amount that Kelly donated. Jennifer donated $\frac{1}{3}$ of the amount that Sarah donated. Jennifer donated \$40 less than Sarah.
- (a) How much money did Jennifer and Sarah donate altogether?
- (b) How much more money than Sarah did Kelly donate?

Ans : (a) _____ [3]

(b) _____ [2]

END OF PAPER

SCHOOL : RULANG PRIMARY SCHOOL
 LEVEL : PRIMARY 5
 SUBJECT : MATHEMATICS
 TERM : 2022 SA2

PAPER 1 BOOKLET A

Q 1	Q2	Q3	Q4	Q5	Q6	Q7	Q8	Q9	Q10
4	1	3	2	1	2	1	2	4	4
Q 11	Q12	Q13	Q14	Q15					
4	2	2	2	4					

PAPER 1 BOOKLET B

Q16)	5062008	
Q17)	284100	
Q18)	3.006kg	
Q19)	$4 \div 6 = \frac{4}{6}$ $= \frac{2}{3} \text{ m}$	
Q20)	$180 - 41 = 139^\circ$	
Q21)	$48 \div 4 = 12$ $12 \times 3 = 36\text{kg}$	
Q22)	$20 + 24 + 26 = 70$ O : P : TF 20 : 26 : 70 10 : 13 : 35	
Q23)	$300.5 \div 50 = 300.5 \div 10 \div 5$ $= 30.05 \div 5$ $= 6.01\text{kg}$	
Q24)	$18 \div 3 = 6$ $6 \times 18 \times 9 = 108 \times 9$ $= 972\text{cm}^3$	

Q25)	$180 - 125 = 55^\circ$									
Q26)	a) $\frac{4}{5} = \frac{80}{100}$ $= 80\%$ b) $\frac{7.5}{100} = 0.075$									
Q27)	$3235 - 1435 = 1800$ $1800 \div 300 = 6\text{months}$									
Q28)	$\frac{1}{2} \times 10 \times 40 = 200\text{cm}^2$									
Q29)	$\frac{1}{2} \times 12 \times 3 = 18\text{cm}^2$									
Q30)	<table border="1" style="margin-left: auto; margin-right: auto;"> <tr> <td style="text-align: center;">√</td> <td></td> <td></td> </tr> <tr> <td></td> <td></td> <td style="text-align: center;">√</td> </tr> <tr> <td></td> <td style="text-align: center;">√</td> <td></td> </tr> </table>	√					√		√	
√										
		√								
	√									

PAPER 2

Q1)	$37 - 4 = 33$ $33 \div 3 = 11$ $11 \times 4 = 44$ $44 - 37 = 7\text{years}$
Q2)	$36.8 - 18.8 = 18$ $18 \div 15 = 1.2$ $0.2 \times 1000 = 200$ Ans: 1kg 200g
Q3)	$280 + 320 + 304 = 904$ $295 \times 4 = 1180$ $1180 - 904 = \$276$
Q4)	$21 \div 3 = 7$ $\frac{1}{2} \times 14 \times 7 = 49\text{cm}^2$
Q5)	$5 + 1 = 6$ $18 \div 6 = 3$ $3 \times 5 = 15$ $\frac{1}{2} \times 15 \times 15 = 112.5\text{cm}^2$
Q6)	$9 \times 2 = 18$ $7 \times 3 = 21$ $4.50 \times 2 = 9$ $18 + 21 + 9 = \$48$

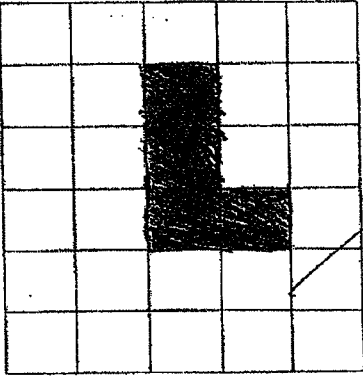
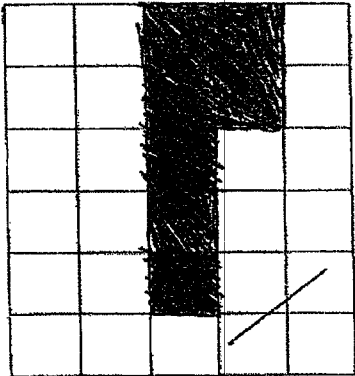
Q7)	$\frac{3}{4} = \frac{9}{12}$ $\frac{1}{3} = \frac{4}{12}$ $9 - 4 = 5$ $15 \div 5 = 3$ $3 \times 12 = 36$ $36 \times 2 = \$72$
Q8)	<p>a) $18 \times 40 \times 30 = 21600 \text{cm}^3$</p> <p>b) $5 \times 40 \times 30 = 6000$ $21600 - 6000 = 15600$ $15600 \div 3 = 5200 \text{cm}^3$</p>
Q9)	<p>a) 12cm^3</p> <p>b)</p> <div style="display: flex; justify-content: space-around; align-items: center;"> <div style="text-align: center;">  <p>Front View</p> </div> <div style="text-align: center;">  <p>Top View</p> </div> </div>
Q10)	<p>a) $180 - 36 - 36 = 108^\circ$</p> <p>b) $180 - 90 - 36 = 54^\circ$</p>
Q11)	$600 \div 200 = 3$ $30 \div 5 = 6$ $3 \times 4.50 = 13.50$ $6 \times 3.60 = 21.60$ $13.50 + 21.60 = \$35.10$
Q12)	<p>a) $120 - 40 = 80$ $80 \div 20 = 4\ell$</p> <p>b) $4 \times 4 = 56$ $56 + 40 = 96$ $\frac{96}{40} = \frac{4}{5}$</p>

Q13)	<p>a) $50 + 40 + 90 + 110 + 100 = 390$ $390 \div 5 = 78$cupcakes</p> <p>b) $120 \times 7 = 840$ $840 - 390 = 450$cupcakes</p>
Q14)	<p>a) $100 - 40 - 25 = 35$ $\frac{35}{100} \times 8888 = \\3110.80</p> <p>b) $\frac{40}{100} \times 8888 = 3555.20$ $3555.20 - 3110.80 = \\$444.40$</p>
Q15)	<p>a) $0.60 + 0.40 = 1$ $1 \times 2 = 2$ $10 - 2 = 8$ $8 \div 10 = 0.80$ $0.80 + 1 = \\$1.80$</p> <p>b) $10 + 0.80 + 0.40 = \\$11.20$</p>
Q16)	<p>a) $180 - 65 - 65 = 50$ $180 - 76 - 50 = 54^\circ$</p> <p>b) $180 - 54 - 42 = 84$ $180 - 84 - 65 = 31^\circ$</p>
Q17)	<p>a) $3 - 1 = 2$ $40 \div 2 = 20$ $20 \times 4 = \\$80$</p> <p>b) $80 \div 20 = 4$ $4 \times 15 = 60$ $4 \times 36 = 144$ $144 - 60 = \\$84$</p>