



HENRY PARK PRIMARY SCHOOL
2019 SEMESTRAL EXAMINATION-2
MATHEMATICS
PRIMARY 5

PAPER 1
(BOOKLET A)

Name: _____ ()

Parent's Signature

Class: Primary 5 _____

Marks:

Paper 1	Booklet A	20
	Booklet B	25
Paper 2		55
Total		100

Total Time for Booklets A and B: 1 hour

Do not turn over this page until you are told to do so.

Follow all instructions carefully.

Answer all questions.

Shade your answers in the Optical Answer Sheet (OAS) provided.

You are **not** allowed to use a calculator.

Questions 1 to 10 carry 1 mark each. Questions 11 to 15 carry 2 marks each.
For each question, four options are given. One of them is the correct answer.
Make your choice (1, 2, 3 or 4) and shade your answer in the Optical Answer Sheet.

(20 marks)

1 What is the value of the digit 6 in 2.056?

- (1) 6 ones
- (2) 6 tenths
- (3) 6 hundredths
- (4) 6 thousandths

2 Round 30 164 to the nearest hundred.

- (1) 30 000
- (2) 30 100
- (3) 30 160
- (4) 30 200

3 How many quarters are there in $4\frac{1}{2}$?

- (1) 8
- (2) 9
- (3) 17
- (4) 18

4 Express $\frac{2}{5}$ hour in minutes.

- (1) 12 min
- (2) 20 min
- (3) 24 min
- (4) 40 min

5 Arrange these numbers from the smallest to the greatest.

0.14,	0.104,	0.4
-------	--------	-----

	<u>Smallest</u>		<u>Greatest</u>
(1)	0.104,	0.4,	0.14
(2)	0.4,	0.14,	0.104
(3)	0.104,	0.14,	0.4
(4)	0.14,	0.4,	0.104

6 Find the value of $54 - 30 \div 3 \times 4$

- (1) 14
- (2) 2
- (3) 32
- (4) 176

- 7 In the figure, AXD and CXE are straight lines.
Given that $\angle EXD = 118^\circ$, find $\angle BXC$.

- (1) 28°
- (2) 62°
- (3) 76°
- (4) 152°

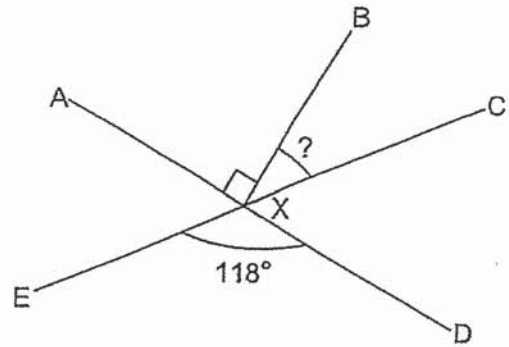

- 8 A square has an area of 100 cm^2 . Find the perimeter of the square.

- (1) 10 cm
- (2) 25 cm
- (3) 40 cm
- (4) 50 cm

- 9 The charges for renting a car are shown below.

Monday – Friday:	\$45 per day
Saturday – Sunday:	\$60 per day

Mr Manoj rented a car from Tuesday to Sunday. How much did he pay?

- (1) \$180
- (2) \$270
- (3) \$285
- (4) \$300

- 10 The square grid below shows the locations of the library and the market in a town.

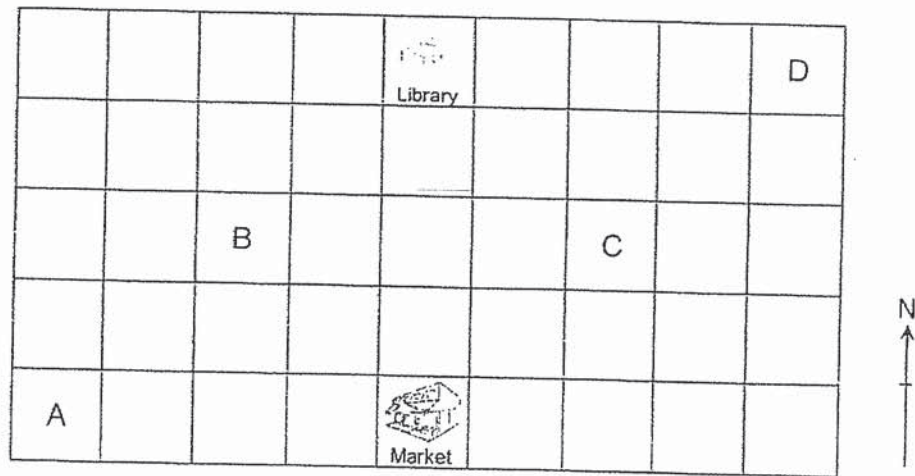

A new shopping mall will be built at a location South-West of the library and North-West of the market.

At which of the following locations, A, B, C or D, will the new shopping mall be built?

- (1) A
 - (2) B
 - (3) C
 - (4) D
- 11 What percentage of the figure is shaded?

- (1) 11%
- (2) 25%
- (3) 44%
- (4) 55%

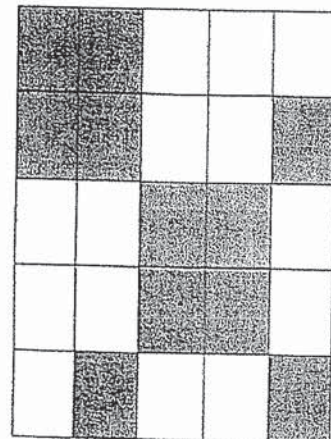

- 12 The figure below is made up of 2 squares of sides 5 cm and 3 cm., Find the area of the shaded parts.

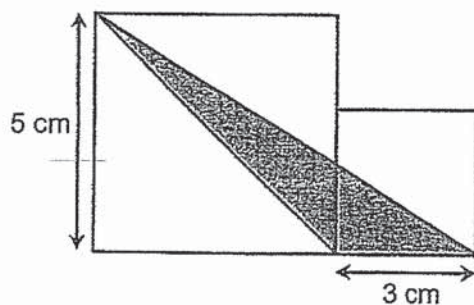

- (1) 7.5 cm^2
(2) 12.5 cm^2
(3) 15 cm^2
(4) 25 cm^2
- 13 Kelly bought 24 buns. How much did she pay for the buns?

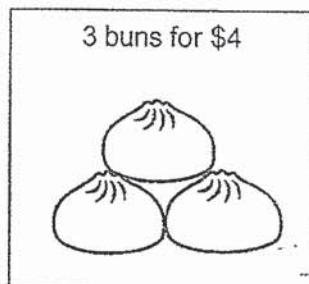

- (1) \$6
(2) \$8
(3) \$18
(4) \$32

- 14 Sanjay had a box containing some fruits. $\frac{3}{5}$ of the fruits were apples.
 $\frac{1}{4}$ of the apples were red and the remaining apples were green.
What fraction of the fruits in the box were green apples?

(1) $\frac{3}{4}$

(2) $\frac{3}{20}$

(3) $\frac{7}{20}$

(4) $\frac{9}{20}$

- 15 Jenny had 12 more stickers than Elly at first.
Jenny gave 48 of her stickers to Elly.
In the end, Elly had 4 times as many stickers as Jenny.
How many stickers did Jenny have in the end?

(1) 12

(2) 15

(3) 21

(4) 28



HENRY PARK PRIMARY SCHOOL
2019 SEMESTRAL EXAMINATION 2
MATHEMATICS
PRIMARY 5

PAPER 1
(BOOKLET B)

Name: _____ ()

Class: Primary 5 _____

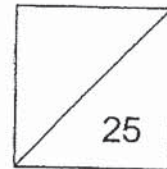

Total Time for Booklets A and B: 1 hour

Do not turn over this page until you are told to do so.

Follow all instructions carefully.

Answer all questions.

Write your answers in this booklet.

You are **not** allowed to use a calculator.

Questions 16 to 20 carry 1 mark each. Write your answers in the spaces provided.
For questions which require units, give your answers in the units stated.

(5 marks)

Do not write
in this space

16 Write nine hundred and five thousand and forty-two in numerals.

Ans: _____

17 Express $7\frac{9}{25}$ as a decimal.

Ans: _____

18 Shade one more square so that the figure becomes symmetrical.

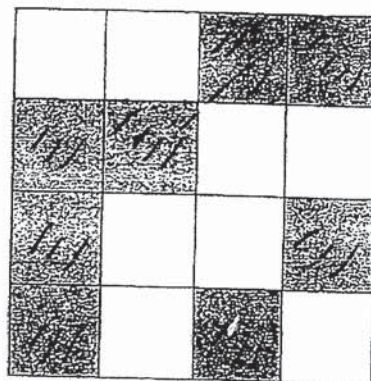

- 19 Ms Lee left the market at 11.20 a.m. She was at the market for 1 h 25 min.
What time did she arrive at the market?

Do not write
in this space

Ans: _____ a.m.

- 20 How much did Clive pay for the pair of shoes after the discount?



Ans: \$ _____

Questions 21 to 30 carry 2 marks each. Show your working clearly and write your answers in the spaces provided. For questions which require units, give your answers in the units stated.

Do not write in this space

(20 marks)

- 21 The distance between Albert's house and Coby's house is 1.6 km. Albert's house is 950 m away from the bus stop. What is the distance (in km) between Coby's house and the bus stop?

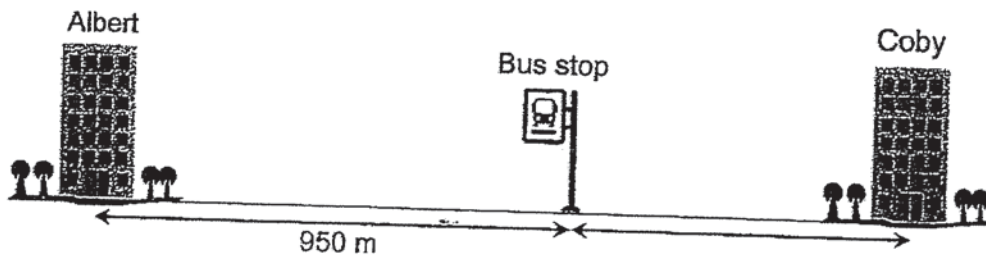

Ans: _____ km

- 22 Mr Kim had some black pens and 91 green pens. After he gave away 27 black pens and 42 green pens, he had 309 pens left. How many black pens did he have at first?

Ans: _____

23 1 kg of flour was packed equally into 7 jars. What is the total mass of flour (in kg) in 3 such jars?

Do not write
in this space

Ans: _____ kg

24 In a company, there were a total of 1134 Chinese, Malay and Indian workers in the ratio 5 : 3 : 1. How many Chinese workers were there in the company?

Ans: _____

25 A class of students were asked to choose a favourite colour each. 20% of the students chose blue. $\frac{1}{3}$ of the students chose pink and the rest chose green. What fraction of the class of students chose green?

Ans: _____

- 26 Zayn had \$400. He spent \$74 and saved the rest. What percentage of his money he save?

Do not write
in this space

Ans: _____ %

- 27 In the figure, ACD and BCE are straight lines. ABC is an equilateral triangle and CDE is a right-angled triangle. Find $\angle CED$.

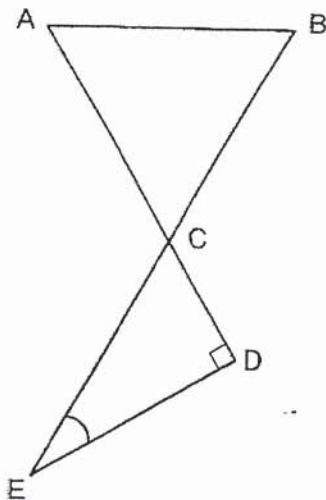

Ans: _____ °

- 28 The table below shows the scores of 4 students in a game. Given that the average score of each student is 35, find Devi's score.

Name	Score
Ahmad	42
Betty	25
Cathy	33
Devi	?

Do not write
in this space

Ans: _____

- 29 In the figure, PQR is an isosceles triangle where $PQ = PR$. Given that PQS is a straight line, find $\angle RQS$.

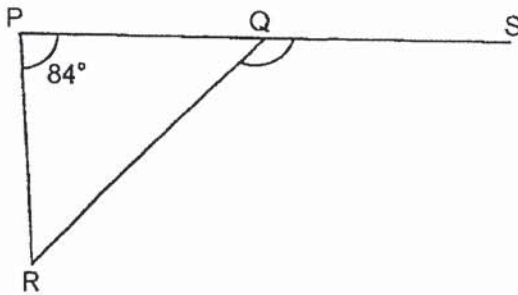

Ans: _____

- 30 Jack had a square piece of paper. He cut out a rectangle from the square piece of paper as shown below. The area of the rectangle is 36 cm^2 . What was the area of the square piece of paper before it was cut?

Do not write
in this space

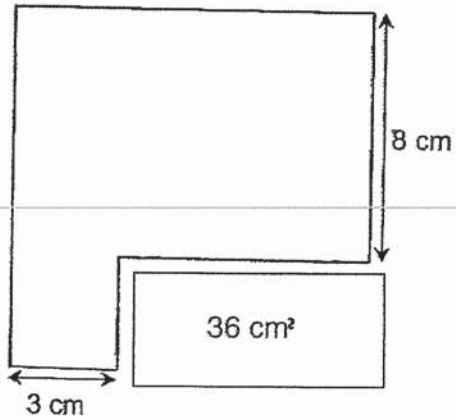

Ans: _____ cm^2

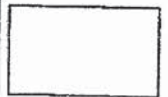



HENRY PARK PRIMARY SCHOOL
2019 SEMESTRAL EXAMINATION 2
MATHEMATICS
PRIMARY 5

PAPER 2

Name: _____ ()

Class: Primary 5 _____

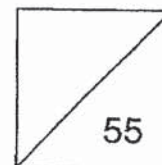

Time for Paper 2: 1 h 30 min

Do not turn over this page until you are told to do so.

Follow all instructions carefully.

Answer all questions.

Show your working clearly as marks are awarded for correct working.

Write your answers in this booklet.

You are allowed to use a calculator.

Questions 1 to 5 carry 2 marks each. Show your working clearly and write your answers in the spaces provided. For questions which require units, give your answers in the units stated.

(10 marks)

Do not write
in this space

- 1 Mr Gan deposits \$5975 in a bank for one year.
The interest rate is 1.4% per year. What is the total amount of money Mr Gan will have in the bank at the end of one year?

Ans: \$ _____

- 2 Mdm Wee paid \$154.95 for 3 pairs of similar pants and 7 similar blouses.
Each pair of pants cost \$4.65 more than each blouse.
How much did each pair of pants cost?

Ans: \$ _____

3

The line graph below shows the amount of money Joshua saved in each month from January to May.

Do not write
in this space

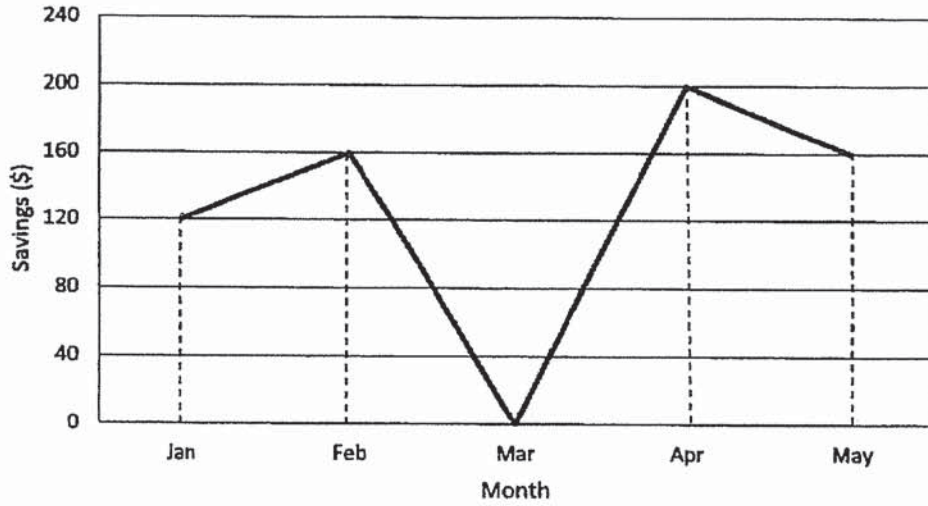

What was the average amount of money he saved in each month from January to May?

Ans: \$ _____

- 4 The figure is made up of ten identical isosceles triangles. O is the centre of the figure. Find $\angle OJK$.

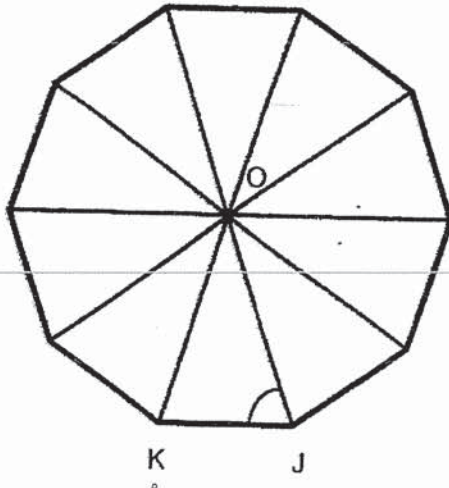

Do not write
in this space

Ans: _____ °

- 5 A machine started printing posters at 8.00 a.m. at the rate of 1750 posters per hour. After every 3 hours of printing, it was stopped for an hour. How many posters were printed in total by 5 p.m. on the same day?

Ans: _____

For questions 6 to 17, show your working clearly and write your answers in the spaces provided. The number of marks available is shown in the brackets [] at the end of each question or part-question.

(45 marks)

Do not write in this space

- 6 The bar graph shows the number of notebooks sold in 3 months. The bar that shows the number of notebooks in January is not drawn.

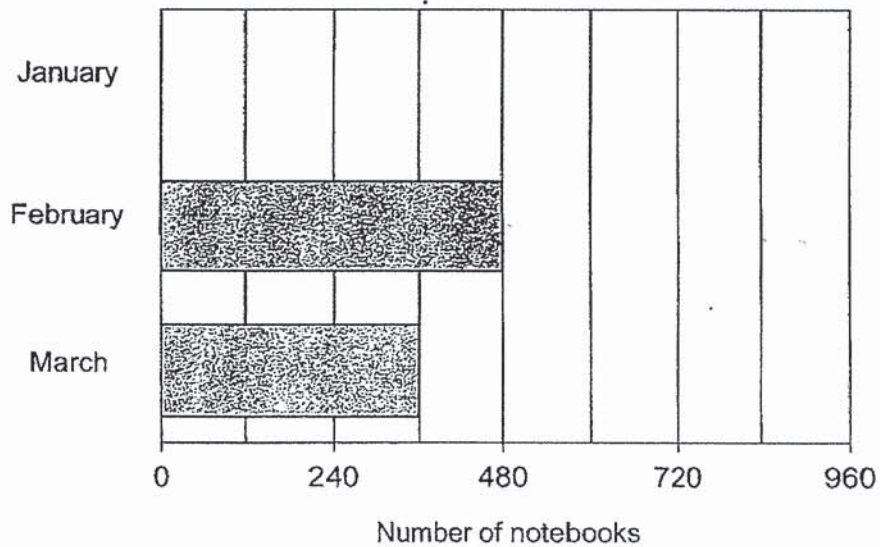

$\frac{3}{8}$ of the total number of notebooks sold in the 3 months were sold in January. How many notebooks were sold in January?

Ans: _____ [3]

- 7 In the figure, ABCD is a parallelogram and ADEF is a rhombus. Find $\angle DAF$.

Do not write
in this space

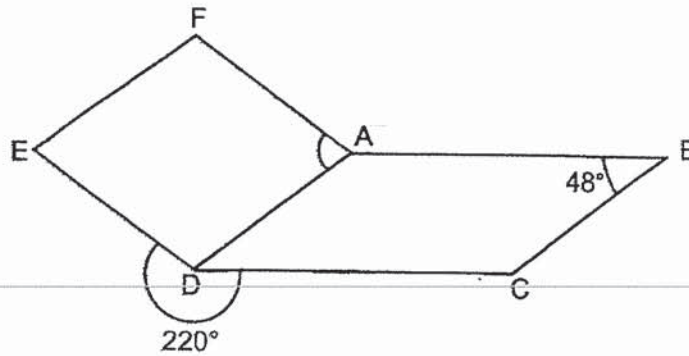

Ans: _____ [3]

- 8 Mrs Ramesh paid \$172.85 for a vase and 20 stalks of roses.
Mrs Tan paid \$457.85 for a similar vase and 58 stalks of roses.
What was the cost of one such vase?

Ans: _____ [3]

9

Mrs Ang baked 164 more muffins than cupcakes.

After selling $\frac{3}{4}$ of the muffins and half of the cupcakes, she had a total of 344 muffins and cupcakes left.

How many muffins and cupcakes did Mrs Ang bake altogether?

Do not write
in this space

Ans: _____ [3]

- 10 The table below shows how much a shop charges a customer for renting a pair of rollerblades.

Do not write
in this space

First hour	\$8.50
Every additional $\frac{1}{2}$ hour	\$3.50

Ms Chan paid \$26 for renting a pair of rollerblades starting from 09 00.
What would be the latest time she must return the pair of rollerblades to the shop?

Ans: _____ [3]

- 11 A container measuring 25 cm by 16 cm by 48 cm was $\frac{1}{3}$ -filled with water at first. James poured some water into the container. In the end, the height of the water level in the container was 20 cm as shown below.

Do not write
in this space

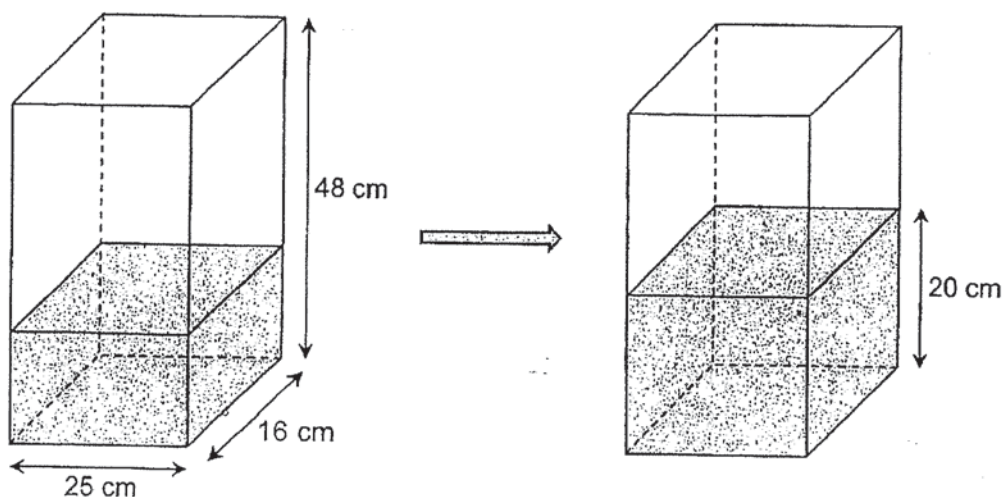

- (a) How much water did James pour into the container?
- (b) James then poured all the water in the container into several identical jugs. Given that each jug can hold at most 1.25 l of water, what is the least number of jugs he would need?

Ans: (a) _____ [2]

(b) _____ [2]

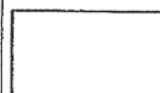

- 12 There were 525 students gathering at a hall for a concert. 52% of the students were boys. At the end of the concert, 45 boys left the hall. What percentage of the remaining students were girls?

Do not write
in this space

Ans: _____ [3]

- 13 The rectangular piece of wood shown in Figure 1 has a perimeter of 68 cm. Mdm Fatimah arranged 4 such rectangular pieces of wood to form a figure as shown in Figure 2.

Do not write in this space

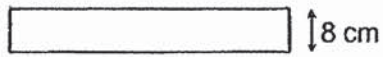

Figure 1

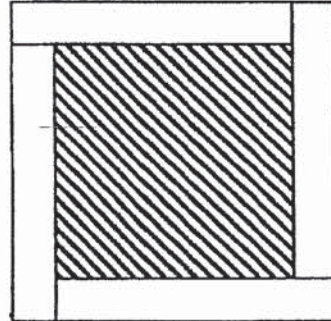
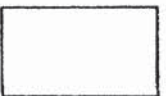

Figure 2

- (a) Find the length of the rectangular piece of wood.
(b) Find the shaded area in Figure 2.

Ans: (a) _____ [2]

(b) _____ [3]



- 14 The table shows the prices of different types of files sold in a shop.

Type of file	Price of each file
Clear	\$1.20
Box	\$2.30
Ring	\$1.80

Rina bought some clear files, box files and ring files from the shop in the ratio 1 : 3 : 2. She spent a total of \$81.90. How many files did Rina buy altogether?

Do not write
in this space

Ans: _____ [4]

15 In the figure, ABCD is a square. $AE = AB$ and $\angle CAE = 19^\circ$.

(a) Find $\angle m$.

(b) Find $\angle n$.

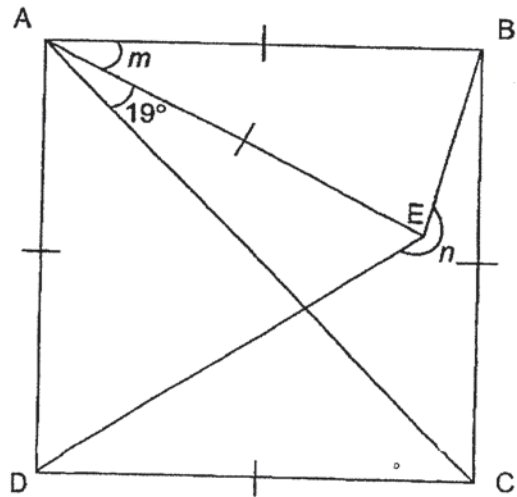

Do not write in this space

Ans: (a) _____ [1]

(b) _____ [3]

16 Jacob spent $\frac{2}{5}$ of his money on 7 sandwiches and 27 curry puffs for a party. The cost of each sandwich is 3 times the cost of each curry puff. He bought some more sandwiches with $\frac{5}{6}$ of his remaining money.

Do not write
in this space



- (a) How many curry puffs could be bought with the same amount of money paid for 7 sandwiches?
- (b) How many sandwiches did Jacob buy altogether?

Ans: (a) _____ [1]

(b) _____ [4]

- 17 Collin and Debbie bought pencils and erasers at the prices shown below.

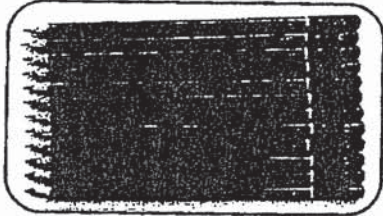
Do not write
in this space

<p>\$4.90 per box of 12 pencils</p>  <p>\$4.90</p>	<p>\$1.40 per pack of 3 erasers</p>  <p>\$1.40</p>
---	--

- (a) Collin bought an equal number of pencils and erasers. He spent a total of \$84. How many pencils and erasers did he buy altogether?
- (b) Debbie spent an equal amount of money on pencils and erasers. What is the least possible number of erasers and pencils that she could have bought in total?

Ans: (a) _____ [3]

(b) *0* _____ [2]

ANSWER KEY

YEAR : 2019
LEVEL : PRIMARY 5
SCHOOL : HENRY PARK PRIMARY SCHOOL
SUBJECT : MATHEMATICS
TERM : SA2

PAPER 1 : BOOKLET A

Q1	Q2	Q3	Q4	Q5	Q6	Q7	Q8
4	4	4	3	3	1	1	3
Q9	Q10	Q11	Q12	Q13	Q14	Q15	
4	2	3	1	4	4	4	

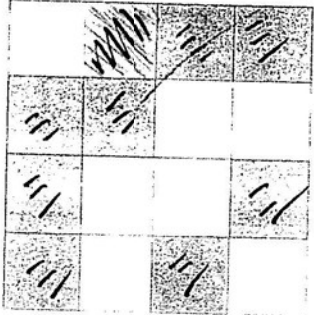
Q16	905 402			
Q17	7.36			
Q18				
Q19	<table style="margin-left: auto; margin-right: auto; border-collapse: collapse;"> <tr> <td style="border: 1px solid black; padding: 2px;">5min</td> <td style="border: 1px solid black; padding: 2px;">1hour</td> <td style="border: 1px solid black; padding: 2px;">20min</td> </tr> </table> <p style="text-align: center;">9.55am 10.00am 11.00am 11.20am</p> <p>Ans: 9.55 a.m.</p>	5min	1hour	20min
5min	1hour	20min		
Q20	$25\% \times \$200 = \50 $\$200 - \$50 = \$150$			
Q21	$1600 - 950 = 650\text{m}$ $650\text{m} = 0.65\text{km}$ Ans: 0.65km			
Q22	$9 + 27 + 42 = 378$ $378 - 91 = 287$			
Q23	$1000\text{g} = 1\text{ kg}$ $1 \div 7 \times 3 = \frac{3}{7}\text{kg}$			
Q24	$1134 \div 9 = 126$ $126 \times 5 = 630$			
Q25	$20\% \rightarrow \frac{1}{5}$ $1 - \frac{1}{5} - \frac{1}{3} = \frac{15}{15} - \frac{3}{15} - \frac{5}{15} = \frac{7}{15}$			
Q26	$400 - 76 = 326$ $326 \div 400 = 81.5\%$			

Q27	$\angle CED = 90 - 60 = 30^\circ$
Q28	$35 \times 4 = 140$ $140 - 42 - 25 - 33 = 40$
Q29	$\angle PQR = (180 - 84) \div 2 = 48^\circ$ $\angle RQS = 180 - 48 = 132^\circ$
Q30	$9 \times 4 = 36\text{cm}^2$ $9 + 3 = 8 + 4 = 12\text{cm}$ (length of square) $12 \times 12 = 144\text{cm}^2$

PAPER 2

Q1	$\$5975 \div 100 = \59.75 $\$59.75 \times 1.4 = \83.65 $\$59.75 + \$83.65 = \$6058.65$
Q2	$\$154.95 - (\$4.65 \times 3) = \$141.00$ $\$141 \div 10 = \14.10 $\$14.10 + \$4.65 = \$18.75$
Q3	$120 + 160 + 0 + 200 + 160 = 640$ $640 \div 5 = 128$
Q4	$360 \div 10 = 36$ $(180 - 36) \div 2 = 72$
Q5	Total time = 9 hours Rest 2 hours and remain 7 hours $1750 \times 7 = 12250$
Q6	$840 \div (8 - 3) = 168$ $168 \times 3 = 504$ notebooks
Q7	$\angle ADE = 360 - 220 - 48 = 92^\circ$ $\angle DAF = 180 - 92 = 88^\circ$
Q8	38 roses \rightarrow $\$457.85 - \$172.85 = \$285$ 1 rose \rightarrow $\$285 \div 35 = \7.50 20 rose \rightarrow $\$7.50 \times 20 = \150 1 vase \rightarrow $\$172.85 - \$150 = \$22.85$ at first) $M : C = 4u + 164 : 4u$ (in the end) $M : C = 4u \times \frac{1}{4} + 164 \times \frac{1}{4} : 4u \times \frac{1}{2} \rightarrow M : C = 1u + 41 : 2u$ $3u + 41 = 344$ $3u = 344 - 41 = 303$ $1u = 101$ $8u + 164 = 8 \times 101 + 164$ $= 972$
Q10	$\$26 - \$8.50 = \$17.50$ $\$17.50 \div \$3.50 = 5$ $5 \times \frac{1}{2} = 2\frac{1}{2}$ Answer : 12 30

Q11	<p>(a) Base area $\rightarrow 25 \times 16 = 400\text{cm}^2$ $48 \times \frac{1}{3} = 16$ $20 + 16 = 4\text{cm}$ (diff in height) $4\text{cm} \times 400\text{cm}^2 = \underline{1600\text{cm}^3}$</p> <p>(b) $1.25\text{l} = 1250\text{cm}^3$ $20\text{cm} \times 400\text{cm}^2 = 8000\text{cm}^3$ $8000 \div 1250 = 6.4$ Ans: 7 jugs</p>																
Q12	<p>$525 \div 100 = 5.25$ $5.25 \times 52 = 273$ $273 - 45 = 228$ $525 - 273 = 252$ girls $252 + 228 = 480$ $252 \div 480 = 52.5\%$</p>																
Q13	<p>(a) $68 - (8 \times 2) = 52$ $52 \div 2 = \underline{26\text{cm}}$</p> <p>(b) length of square $\rightarrow 26 - 8 = 18\text{cm}$ $18 \times 18 = \underline{324\text{cm}^2}$</p>																
Q14	<p>C : B ; R = 1 : 3 : 2 $(\\$1.20 \times 1) + (\\$2.30 \times 3) + (\\$1.80 \times 2)$ $= \\$11.70$ $\\$81.90 \div \\$11.70 = 7$ $7 \times 6 = 42$</p>																
Q15	<p>(a) $\angle m = 45 - 19 = \underline{26^\circ}$ (b) $\angle AEB = (180 - 26) \div 2 = 77$ $\angle DAE = 45 + 19 = 64$ $\angle AED = (180 - 64) \div 2 = 58$ $\angle n = 360 - 58 - 77 = \underline{225^\circ}$</p>																
Q16	<p>(a) $7 \times 3 = \underline{21}$ curry puffs (b) Assume all puff in $\frac{2}{5}$ money $\rightarrow 21 + 27 = 48\text{u}$ $\frac{3}{5}$ of his money $\rightarrow = 48\text{u} \div 2 \times 3 = 72\text{u}$ $72\text{u} \times \frac{5}{6} = 60\text{u}$ 60 puff = 20 sandwich ($60 \div 3$) $20 + 7 = \underline{27}$ sandwiches</p>																
Q17	<p>$3 \times 4 = 12$ (a) $\\$1.40 \times 4 = \\5.60 $\\$5.60 + \\$4.90 = \\$10.50$ $\\$84 \div \\$10.50 = 8$ $8 \times (12 \times 2) = 192$ (12 pencils and 21 erasers per set)</p>																
(b)	<table border="1"> <tbody> <tr> <td>Pencils</td> <td>\$4.90</td> <td>\$9.80</td> <td></td> <td></td> <td></td> <td></td> <td></td> </tr> <tr> <td>Erasers</td> <td>\$1.40</td> <td>\$2.80</td> <td>\$4.20</td> <td>\$5.60</td> <td>\$7.00</td> <td>\$8.40</td> <td>\$9.80</td> </tr> </tbody> </table> <p>$12 \times 2 + 7 \times 3 = 24 + 21 = 45$ altogether</p>	Pencils	\$4.90	\$9.80						Erasers	\$1.40	\$2.80	\$4.20	\$5.60	\$7.00	\$8.40	\$9.80
Pencils	\$4.90	\$9.80															
Erasers	\$1.40	\$2.80	\$4.20	\$5.60	\$7.00	\$8.40	\$9.80										

3
END