



NAN HUA PRIMARY SCHOOL  
SEMESTRAL ASSESSMENT 1 – 2019  
PRIMARY 5

MATHEMATICS  
PAPER 1  
(BOOKLET A)

Total Time for Booklets A and B: 1 hour

**INSTRUCTIONS TO CANDIDATES**

1. Write your name and index number in the space provided.
2. Do not turn over the page until you are told to do so.
3. Follow all instructions carefully.
4. Answer all questions.
5. Shade your answers in the Optical Answer Sheet (OAS) provided for Questions 1-15.
6. The use of calculators is **NOT** allowed.

Name : \_\_\_\_\_ (       )

Class : 5 \_\_\_\_\_

Date : 16 May 2019

Parent's Signature : \_\_\_\_\_

Questions 1 to 10 carry 1 mark each. Questions 11 to 15 carries 2 marks each. For each question, four options are given. One of them is the correct answer. Make your choice (1, 2, 3 or 4) and shade your answer on the Optical Answer Sheet (OAS)  
(20 marks)

---

1. Round 541.362 to the nearest tenth.

- (1) 540
- (2) 541.4
- (3) 541.36
- (4) 541.462 ( )

2. Express 0.078 as a fraction.

- (1)  $\frac{7}{8}$
- (2)  $\frac{78}{100}$
- (3)  $\frac{78}{1000}$
- (4)  $\frac{780}{1000}$  ( )

3. Which of the following numbers is the largest?

- (1) 0.34
- (2) 0.33
- (3) 0.325
- (4) 0.315 ( )

4.  $\frac{29}{12} \times \frac{4}{7} = \underline{\hspace{2cm}}$

(1)  $\frac{203}{48}$

(2)  $\frac{36}{16}$

(3)  $\frac{33}{19}$

(4)  $\frac{29}{21}$

( - )

5. The table below shows the number of fruits at a fruit stall.

Oranges	Apples	Watermelons
15	12	6

Find the ratio of the number of apples to the number of oranges to the total number of fruits.

(1) 5 : 4 : 2

(2) 4 : 5 : 11

(3) 11 : 5 : 4

(4) 15 : 12 : 6

( )

6. Which of the following is not an equivalent ratio of 4 : 12?

- (1) 1 : 3
- (2) 2 : 6
- (3) 8 : 36
- (4) 32 : 96

( )

7. Find the base of the triangle that is related to the given height EB.

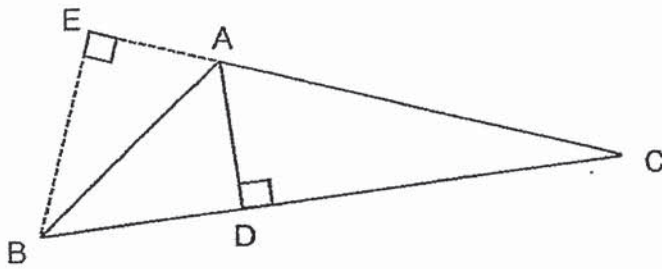

- (1) EC
- (2) BC
- (3) AE
- (4) AC

( )

8. Which of the following figures does not show AB as the line of symmetry?

(1)

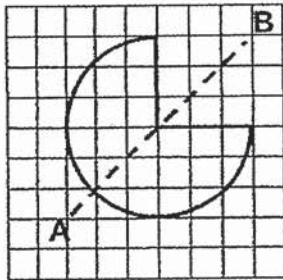

(2)

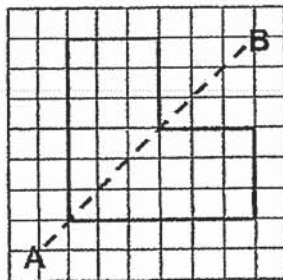

(3)

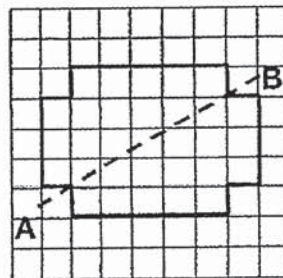

(4)

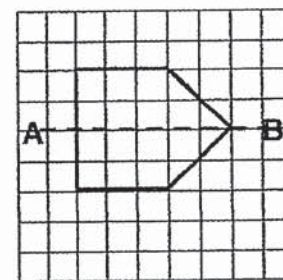

( )

9. The area of a rectangle is  $80 \text{ cm}^2$ .  
Given that the breadth is  $5 \text{ cm}$ , what is the length of the rectangle?

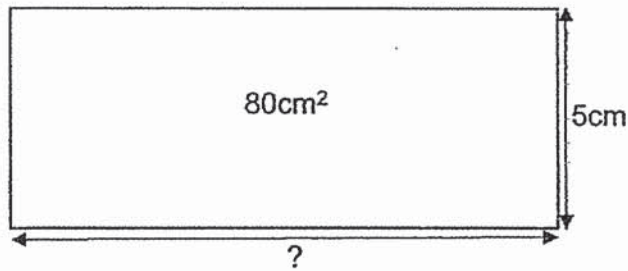

- (1) 70 cm  
(2) 35 cm  
(3) 16 cm  
(4) 11 cm

( )

10. Which two lines are parallel to each other?

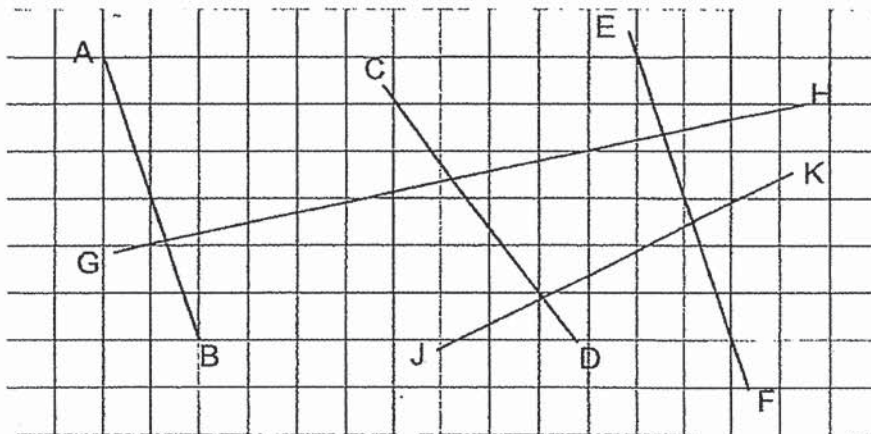

- (1) GH and JK  
(2) CD and JK  
(3) CD and EF  
(4) AB and EF

( )

11. The first common multiple of 6 and 8 is \_\_\_\_\_.

- (1) 1  
(2) 2  
(3) 24  
(4) 48

( )

12. Find the value of  $27 + 42 \times 8 + 6 \div 2$ .

- (1) 555
- (2) 489
- (3) 366
- (4) 279

( )

13. John was given \$500 to spend from July to December.

The graph below shows the amount of money John had left at the end of each month.

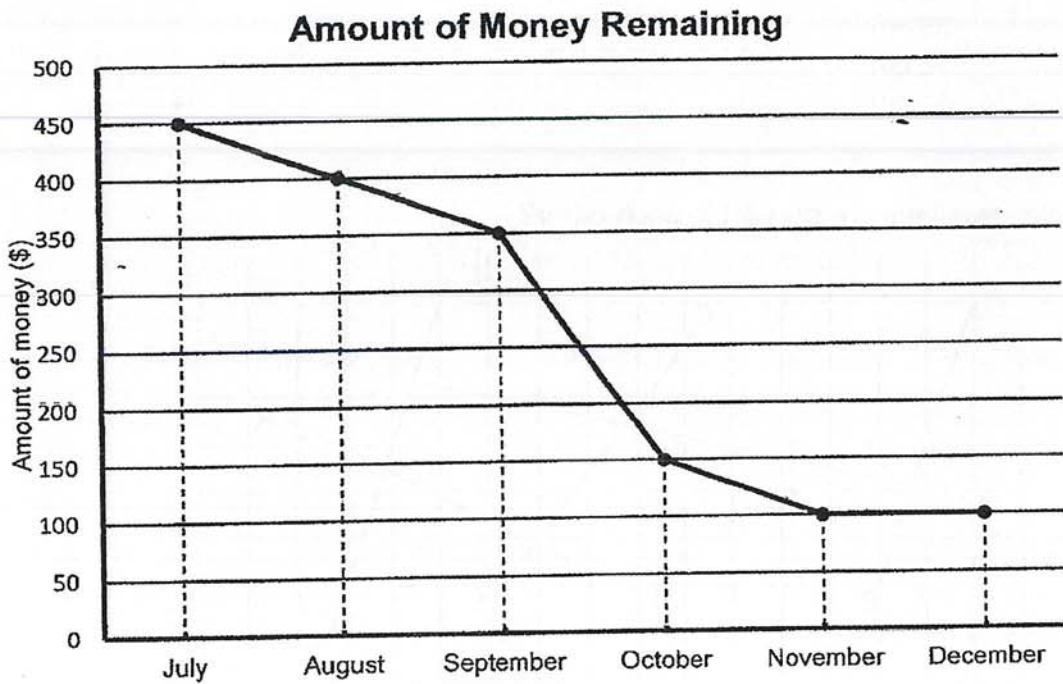

How much money did John spend in the month of October?

- (1) \$150
- (2) \$200
- (3) \$300
- (4) \$350

( )

14. John had 504 boxes of candies. He sold  $\frac{7}{9}$  of it.  
How many boxes of candies were left?

- (1) 56
- (2) 112
- (3) 392
- (4) 648

( )

15. The figure shows an 8-point compass.

John made a  $\frac{3}{4}$  - turn in the anticlockwise direction.

Then, he turned  $135^\circ$  clockwise.

He faced south-east in the end.

Which direction was he facing at the beginning?

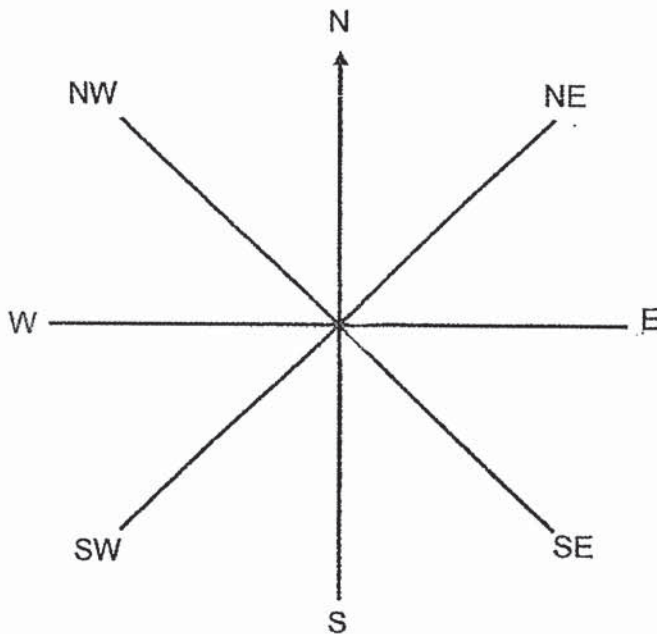

- (1) North
- (2) East
- (3) South
- (4) West

( )





NAN HUA PRIMARY SCHOOL  
SEMESTRAL ASSESSMENT 1 – 2019  
PRIMARY 5

MATHEMATICS  
PAPER 1  
(BOOKLET B)

Total Time for Booklets A and B: 1 hour

**INSTRUCTIONS TO CANDIDATES**

1. Write your name and index number in the space provided.
2. Do not turn over the page until you are told to do so.
3. Follow all instructions carefully.
4. Answer all questions.
5. Write your answers in this booklet.
6. The use of calculators is **NOT** allowed.

**Marks Obtained**

Paper 1	Booklet A		/ 45
	Booklet B		
Paper 2			/ 55
Total			/ 100

Name : \_\_\_\_\_ (       )

Class : 5 \_\_\_\_\_

Date : 16 May 2019

Parent's Signature : \_\_\_\_\_

Questions 16 to 20 carry 1 mark each. Write your answer in the blanks provided. For questions which require units, give your answers in the units stated.

(5 marks)

Do not write  
in this space

16. Round 43 632 kg to the nearest 1000 kg.

Ans: \_\_\_\_\_ kg

17. Express 27 : 36 in the simplest form.

Ans: \_\_\_\_\_

18. Express  $\frac{16}{56}$  in the simplest form.

Ans: \_\_\_\_\_

Subtotal	/ 3
----------	-----

19. Arrange these numbers in order. Begin with the largest number.



--	--	--	--

Largest

Do not write  
in this space

20. Tom took 14 hours to build a model aeroplane. He started at 8.30 a.m.  
What time did he finish building the model aeroplane?

Ans: \_\_\_\_\_ p.m.

Subtotal	/ 2
----------	-----

Questions 21 to 30 carry 2 marks each. Show your working clearly and write your answers in the spaces provided. For questions which require units, give your answers in the units stated.

(20 marks)

Do not write in this space

21. Four fractions are given below. Identify the smallest and largest fractions.

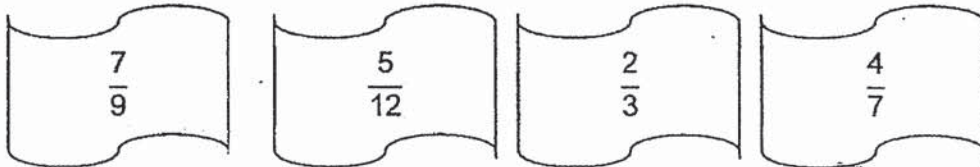

Ans: Smallest \_\_\_\_\_

Ans: Largest \_\_\_\_\_

22. The following diagram shows a triangle ABC.

- a) Measure the length of the line AB.
- b) Measure  $\angle ABC$ .

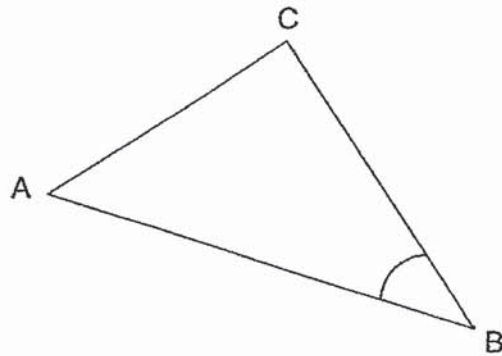

Ans: a) \_\_\_\_\_ cm

b) \_\_\_\_\_ °

Subtotal	/ 4
----------	-----

23. Kimberly bought 3 ℓ of juice.  
She poured all the juice into 8 small bottles equally.  
How much juice did each bottle contain?

Do not write  
in this space

Ans: \_\_\_\_\_ ℓ

24. A factory made 348 toys for an event.  
26 toys were given out as prizes and the rest were sold at \$8 each.  
How much money was collected from the sale of the toys?

Ans: \$ \_\_\_\_\_

Subtotal	/ 4
----------	-----

25. What is the missing number in the box?

$$15 : 45 = \boxed{\phantom{00}} : 27$$

Ans: \_\_\_\_\_

Do not write  
in this space

26. Complete the symmetric figure below with AB as the line of symmetry.

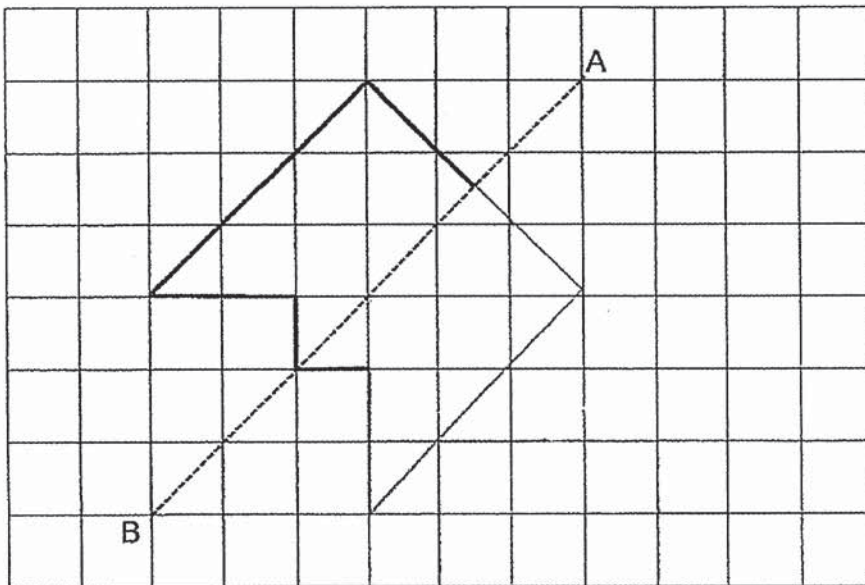

Subtotal	/ 4
----------	-----

Do not write  
in this space

27. Some children participated in a competition and were grouped into 3 teams. They were to clear as many stations as they could and were allowed to clear them in any order.

Only team C managed to clear all the stations.

The table below shows the score each team received at the end of the competition.

Team	Number of stations cleared	Number of points scored
A	6	12
B	5	?
C	9	25

Each of the statement below is either true, false or not possible to tell from the information given. For each statement, put a tick (✓) to indicate your answer.

Statement	True	False	Not possible to tell
There was a total of 20 stations.			
Team B scored fewer points than Team A.			

Subtotal	/ 2
----------	-----

28. Complete the figure below to form a rectangle ABCD.

Do not write  
in this space

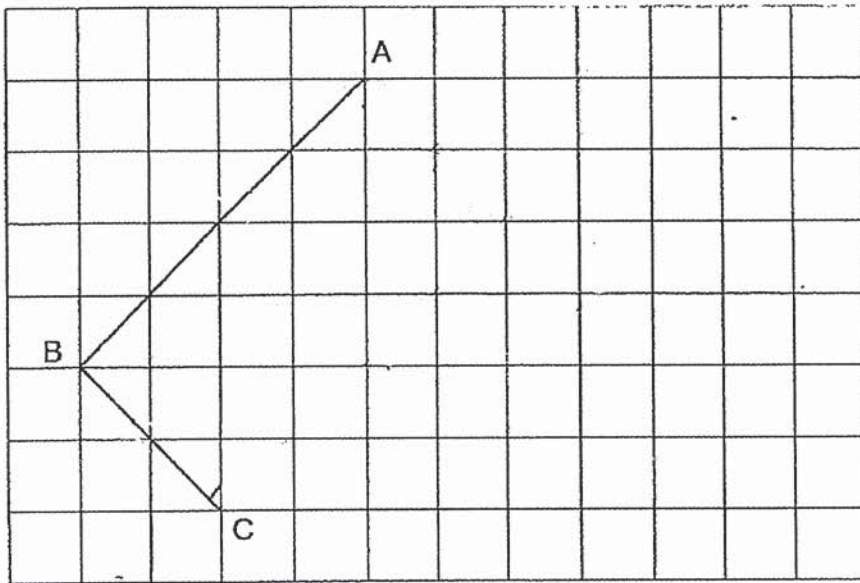

29. 61 children attended a camp.  
Another 11 children decided to join the camp.  
The children were then grouped into 9 groups equally.  
They were tasked to work in pairs in each group.  
How many pairs were there in each group?

Ans: \_\_\_\_\_

<b>Subtotal</b>	<b>/ 4</b>
-----------------	------------



30. Sam bought 7 bags of cherries. The mass of cherries in each bag is 2.84 kg. He found out that 0.62 kg of cherries were spoilt and threw them away. He split the remaining cherries equally into 2 boxes. What was the mass of cherries in each box?

Do not write  
in this space

Ans: \_\_\_\_\_ kg

--- End of Paper 1 ---

Subtotal	/ 2
----------	-----



NAN HUA PRIMARY SCHOOL  
SEMESTRAL ASSESSMENT 1 – 2019  
PRIMARY 5

MATHEMATICS  
Paper 2

Total Time for Paper 2: 1 hour 30 minutes

INSTRUCTION TO CANDIDATES

1. Write your name and index number in the space provided.
2. Do not turn over the page until you are told to do so.
3. Follow all instructions carefully
4. Answer all questions.
5. Write your answers in this booklet.
6. The use of an approved calculator is expected, where appropriate.

Marks Obtained

Total	Max Mark
	55

Name: \_\_\_\_\_ ( )

Class: \_\_\_\_\_

Date: 16 May 2019

Parent's Signature: \_\_\_\_\_

Questions 1 to 5 carry 2 marks each. Show your working clearly and write your answers in the spaces provided. For questions which require units, give your answers in the units stated.

Do not write  
in this space

(10 marks)

1. Jason left his house at 10 20 and took 25 min to cycle from his house to the library. He spent 1 h 30 min in the library and left the library. At what time did he leave the library? Give your answer in 24-hour clock.

Ans: \_\_\_\_\_

2. Find the area of the shaded triangle.

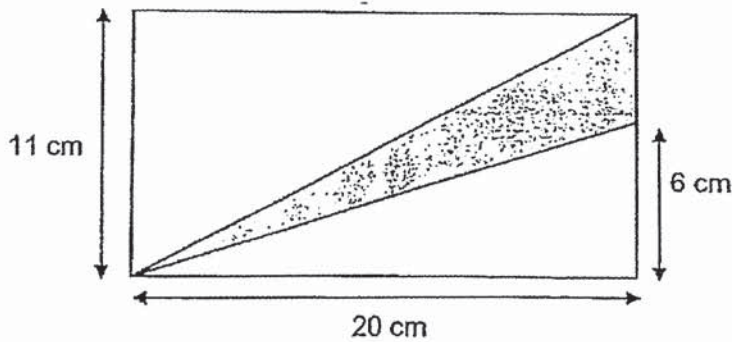

Ans: \_\_\_\_\_ cm<sup>2</sup>

Subtotal	/ 4
----------	-----

3. Diana had 600 g of flour. She used  $\frac{2}{3}$  of the flour to bake a cake and  $\frac{1}{4}$  of the flour to bake a tart. How much flour did Diana use altogether?

Do not write  
in this space

Ans: \_\_\_\_\_ 9

4. The graph below shows the number of books donated by some Primary 5 students. For students who donated at least 2 books, they were each given 2 bookmarks by the school. How many bookmarks were given altogether to these students?

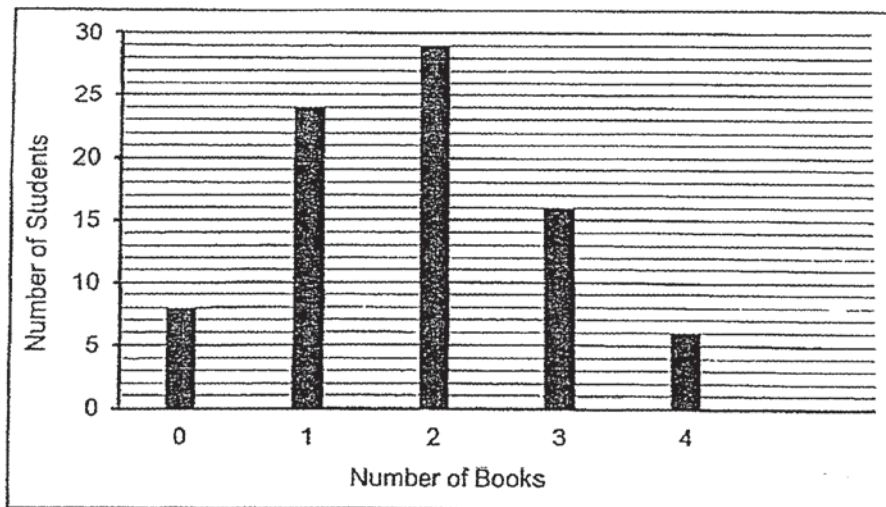

Ans: \_\_\_\_\_

Subtotal	/ 4
----------	-----

5. The table below shows the marks that 3 students scored in a quiz. Use the information below and complete the table.

Do not write  
in this space

(a) Ivan scored a total of 255 marks for all 3 subjects. Find Ivan's Mathematics score.

(b) Jayden scored the lowest for Science and Ivan scored the highest for Science among the 3 students.  
Kenneth's Science score was the highest among his 3 subjects. Find Kenneth's Science score.

Name	English	Mathematics	Science
Ivan	79	(a) _____	91
Jayden	82	86	85
Kenneth	89	87	(b) _____

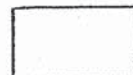

For questions 6 to 17, show your working clearly and write your answers in the spaces provided. The number of marks available is shown in brackets [ ] at the end of each question or part-question.

Do not write  
in this space

(45 marks)

- 
6. Lina and Melissa saved a total of \$572. Lina and Nicole saved a total of \$360. Melissa saved three times as much as Nicole. Find Lina's savings.

Ans: \_\_\_\_\_ [3]

7. Keith bought some game cards. He gave  $\frac{3}{5}$  of them to his brother and  $\frac{1}{4}$  of the remainder to his cousin. After that, Keith had 54 game cards left. How many game cards did Keith buy?

Ans: \_\_\_\_\_ [3]

4

Subtotal	/ 6
----------	-----

Scanned by CamScanner

8. In the figure below, ABCD is a rectangle and EFGD is a square with an area of  $64 \text{ cm}^2$ . Find the total area of the shaded parts.

Do not write  
in this space

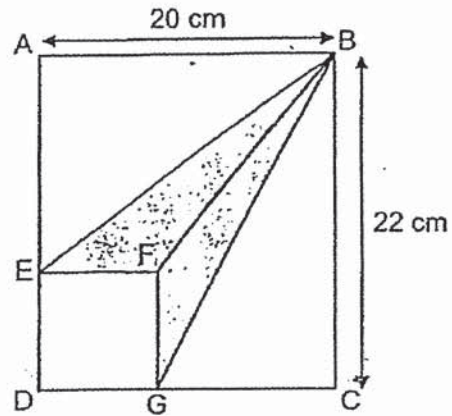

Ans: \_\_\_\_\_ [3]

9. The figure below is made up of a rectangle and a square. Find the value of  $\angle a$ .

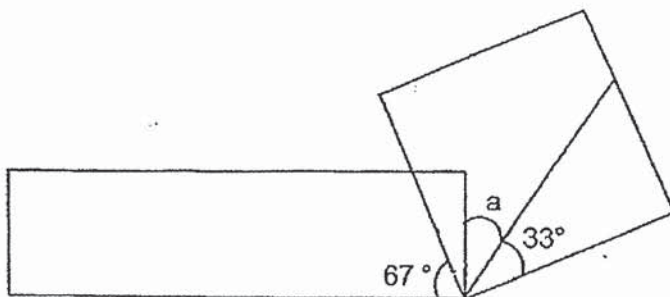

Ans: \_\_\_\_\_ [3]

Subtotal	/ 6
----------	-----

10. At an exhibition, the ratio of the number of adults to the number of children was 7 : 4. There were 108 more adults than children. After some time, 35 adults and 24 children left the exhibition. How many people remained at the exhibition?

Do not write  
in this space

Ans: \_\_\_\_\_ [ 3 ]

11. The total cost of 5 T-shirts and 2 dresses is \$253. The total cost of 3 T-shirts and 6 dresses is \$483. How much does Emily need to pay if she wants to buy 1 T-shirt and 1 dress?

Ans: \_\_\_\_\_ [ 4 ]

Subtotal	17
----------	----



12. The prices of the admission ticket to a museum are shown below.

Do not write  
in this space

Ticket Type	Price per person
Adult	\$ 37
Child (Ages 3 – 12 years old)	\$ 25
Senior (Ages 60 years and above)	\$ 17

The bar graph below shows the number of each type of ticket sold on a Sunday.

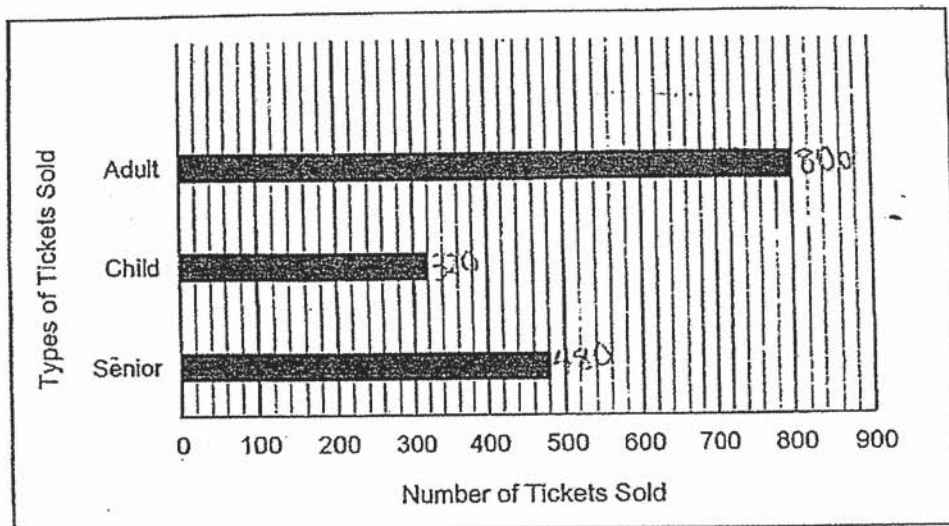

- (a) What fraction of the total number of tickets sold on that Sunday were children tickets? Give your answer in the simplest form.
- (b) What was the total amount collected from the sale of admission tickets on that Sunday?

Ans: a) \_\_\_\_\_ [2]

b) \_\_\_\_\_ [2]

13. The figure below shows a rectangular piece of paper with 2 squares cut out. The side of the bigger square is 4 cm and the side of the smaller square is 2 cm. The area of the remaining piece of paper is  $78 \text{ cm}^2$ . What is the perimeter of the remaining piece of paper?

Do not write  
in this space

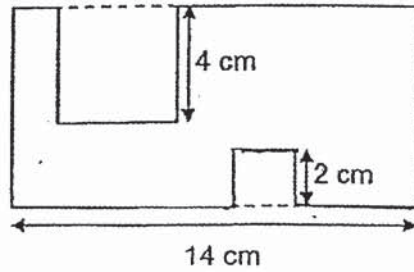

Ans: \_\_\_\_\_ [ 4 ]

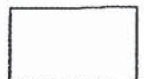

14. Anna, Betsy and Charlene had a total of 168 marbles. Charlene gave 15 marbles to Betsy. Then, Betsy gave 8 marbles to Anna. In the end, the ratio of the number of marbles that Anna had to the number of marbles that Betsy had to the number of marbles that Charlene had is 2 : 5 : 7. How many marbles did Betsy have at first?

Do not write  
in this space

Ans: \_\_\_\_\_ [4]

15. Mr Tan made some fish balls. He sold  $\frac{3}{4}$  of the fish balls in the morning and  $\frac{1}{3}$  of the remaining fish balls in the afternoon. He made another 506 fish balls and had twice the number of fish balls he made at first. How many fish balls did he make at first?

Do not write  
in this space

Ans: \_\_\_\_\_ [ 4 ]

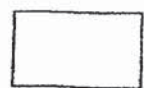

16. Mrs Chen bought 12 kg of flour and 5 kg of sugar to bake some cakes. To bake each cake, the amount of flour required is 3 times the amount of sugar. After baking 8 cakes, she had 3.16 kg of sugar and some flour left.

- (a) How many kilograms of flour were used to bake one cake?
- (b) How many kilograms of flour were left?

Do not write  
in this space

Ans: a) \_\_\_\_\_ [3]

b) \_\_\_\_\_ [2]

17. Container A is completely filled with water and Container B is filled with some water. Half of the water from Container A is poured into Container B.

Do not write  
in this space

- (a) How much water is there in Container B now? Give your answer in millilitres.
- (b) After half of the water was transferred from Container A to Container B, Mr Lim wants to fill Container B with water to the brim. How much more water does he need? Give your answer in litres.

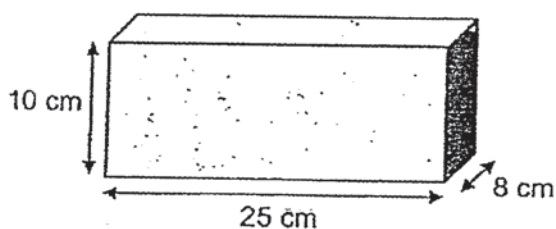

Container A

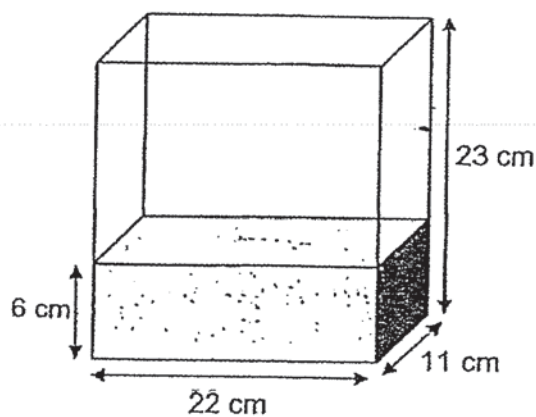

Container B

Ans: a) \_\_\_\_\_ [ 3 ]

b) \_\_\_\_\_ [ 2 ]

— End of Paper 2 —

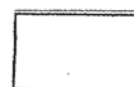

## ANSWER KEY

**YEAR** : 2019  
**LEVEL** : PRIMARY 5  
**SCHOOL** : NAN HUA PRIMARY SCHOOL  
**SUBJECT** : MATHEMATICS  
**TERM** : SA1

### PAPER 1 : BOOKLET A

<b>Q1</b>	<b>Q2</b>	<b>Q3</b>	<b>Q4</b>	<b>Q5</b>	<b>Q6</b>	<b>Q7</b>	<b>Q8</b>
2	3	1	4	2	3	4	3
<b>Q9</b>	<b>Q10</b>	<b>Q11</b>	<b>Q12</b>	<b>Q13</b>	<b>Q14</b>	<b>Q15</b>	
3	4	3	3	2	2	4	

### PAPER 1 : BOOKLET B

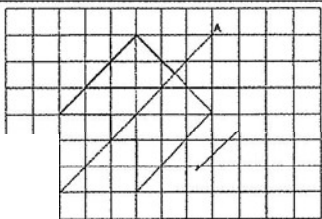
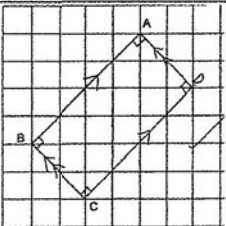
<b>Q16</b>	44000kg
<b>Q17</b>	3 : 4
<b>Q18</b>	$\frac{2}{7}$
<b>Q19</b>	26547 → 26475 → 25674 → 25476
<b>Q20</b>	10.30 p.m.
<b>Q21</b>	Smallest: $\frac{5}{12}$ Largest: $\frac{7}{9}$
<b>Q22</b>	(a) 6.1 (b) 40°
<b>Q23</b>	$3.000\text{L} \div 8 = 0.375\text{L}$
<b>Q24</b>	$348 - 26 = 322$ $322 \times \$8 = \$2576$
<b>Q25</b>	9
<b>Q26</b>	
<b>Q27</b>	(i) False (ii) Not possible to tell
<b>Q28</b>	
<b>Q29</b>	$61 + 11 = 72$ $72 \div 9 = 8$ $8 \div 2 = 4 \text{ pairs}$

Q30	$7 \times 2.84\text{kg} = 19.88\text{kg}$ $19.88\text{kg} - 0.62\text{kg} = 19.26\text{kg}$ $19.26\text{kg} \div 2 = 9.63\text{kg}$
-----	---

PAPER 2

Q1	$10\ 20 + 00\text{h}25\text{m} + 01\text{h}\ 30\text{m} = 11\text{h}\ 75\text{m}$ $\approx 12\ 15$
Q2	Height of shaded triangle $\rightarrow 11 - 6 = 5\text{cm}$ $\frac{1}{2} \times 20 \times 5 = 50\text{cm}^2$
Q3	$600 \times \frac{2}{3} = 400\text{g}$ (cake used) $600 \times \frac{1}{4} = 150\text{g}$ (tart used) $400 + 150 = 550\text{g}$
Q4	Total students receive bookmarks $\rightarrow 29 + 16 + 6 = 51$ $51 \times 2 = 102$ bookmarks
Q5	(a) $255 - 91 - 79 = 85$ (b) 90
Q6	$2N \rightarrow \$572 - \$360 = \$212$ $N \rightarrow \$212 \div 2 = \$106$ $L \rightarrow \$360 - \$106 = \$254$
Q7	$\frac{5}{5} - \frac{3}{5} = \frac{2}{5}$ $\frac{2}{5} \times \frac{1}{4} = \frac{1}{10}$ $\frac{1}{10} \times 3 = \frac{3}{10}$ $3u = 54$ $1u = 54 \div 3 = 18$ $10u = 18 \times 10 = 180$
Q8	$64\text{cm}^2 = 8\text{cm} \times 8\text{cm}$ $\angle\text{EFB} \rightarrow \frac{1}{2} \times 8 \times 14 = 56\text{cm}^2$ $\angle\text{FGB} \rightarrow \frac{1}{2} \times 8 \times 12 = 48\text{cm}^2$ $m^2 + 48\text{cm}^2 = 104\text{cm}^2$
Q9	$-67^\circ = 23^\circ$ $90^\circ - 23^\circ - 33^\circ = 34^\circ$
Q10	$7 - 4 = 3u$ $1u \rightarrow 108 \div 3 = 36$ $36 \times 11 = 396$ $396 - 35 - 24 = 337$



Q11	$[5T + 2D = \$253] \times 3$ $[15T + 6D = \$759]$ $[3T + 6D = \$483]$ $12T = 759 - 483 = 276$ $T = 276 \div 12 = \$23$ $3 \times \$23 + 6D = \$483$ $\$69 + 6D = \$483$ $6D = \$483 - \$69 = \$414$ $D = \$414 \div 6 = \$69$ $T + D = \$23 + \$69 = \$92$
Q12	$320 + 480 + 800 = 1600$ (a) $\frac{320}{1600} = \frac{1}{5}$
(b)	Adult $\rightarrow 800 \times \$37 = \$29600$ Child $\rightarrow 320 \times \$25 = \$8000$ Senior $\rightarrow 480 \times \$17 = \$8160$ $29600 + 8000 + 8160 = \$45760$
Q13	$4 \times 4 = 16\text{cm}^2$ $2 \times 2 = 4\text{cm}^2$ $78 + 16 + 4 = 98\text{cm}^2$ $98 \div 14\text{cm} = 7\text{cm}$ (height of rectangle) $14 + 14 + 7 + 7 + 4 + 4 + 2 + 2$ $= 54\text{cm}$
Q14	$7 + 5 + 2 = 14u$ $1u \rightarrow 168 \div 14 = 12$ In the end Betsy $\rightarrow 12 \times 5 = 60$ $60 + 8 = 68$ $68 - 15 = 53$
Q15	$12u \times 2 = 24u$ $2u + 506 = 24u$ $506 = 24u - 2u = 22u$ $1u = 506 \div 22 = 23$ $12u = 23 \times 12 = 276$ fish balls
Q16	$- 3.16 = 1.84\text{kg}$ $14 \times 3 = 5.52\text{kg}$ (total kg for 8 cakes) $5.52 \div 8 = 0.69\text{kg}$ (b) $12\text{kg} - 5.52\text{kg} = 6.48\text{kg}$
Q17	(a) Half of Container A = $(10 \times 25 \times 8) \div 2 = 1000\text{cm}^3$ Water in Container B = $6 \times 22 \times 11 = 1452\text{cm}^3$ Ans : $1000 + 1452 = 2452\text{ml}$ (b) $23 \times 22 \times 11 = 5566\text{ml}$ $5566 - 2452 = 3114$ $3114\text{ml} = 3.114\text{L}$

3  
END