



HENRY PARK PRIMARY SCHOOL
2019 SEMESTRAL EXAMINATION 1
MATHEMATICS
PRIMARY 5

PAPER 1
(BOOKLET A)

Name: _____ ()

Parent's Signature

Class: Primary 5. _____

Marks:

Paper 1	Booklet A	20
	Booklet B	25
Paper 2		55
Total		100

Total Time for Booklets A and B: 1 hour

Do not turn over this page until you are told to do so.

Follow all instructions carefully.

Answer all questions.

Shade your answers in the Optical Answer Sheet (OAS) provided.

You are **not** allowed to use a calculator.

Questions 1 to 10 carry 1 mark each. Questions 11 to 15 carry 2 marks each.
For each question, four options are given. One of them is the correct answer.
Make your choice (1, 2, 3 or 4) and shade your answer on the Optical Answer Sheet.
(20 marks)

- 1 What is the value of the digit 6 in 1 168 189?
- (1) 60
 - (2) 600
 - (3) 6000
 - (4) 60 000
- 2 Which one of the following numbers is 78 000 when rounded to the nearest thousand?
- (1) 77 449
 - (2) 77 501
 - (3) 78 649
 - (4) 78 901
- 3 Which one of the following is **not** a common factor of 24 and 32?
- (1) 1
 - (2) 2
 - (3) 3
 - (4) 4
- 4 Which of the following fractions is greater than $\frac{5}{12}$?
- (1) $\frac{1}{6}$
 - (2) $\frac{1}{2}$
 - (3) $\frac{1}{3}$
 - (4) $\frac{1}{4}$

- 5 Study the diagram below.
What fraction of the circles are shaded?

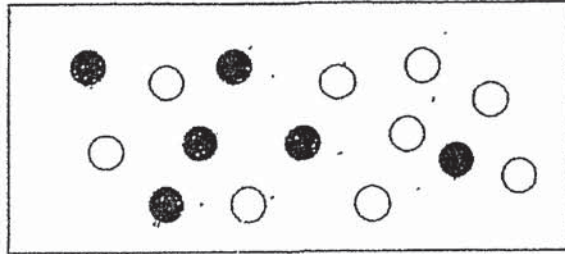

- (1) $\frac{1}{3}$
(2) $\frac{2}{3}$
(3) $\frac{2}{5}$
(4) $\frac{3}{5}$
- 6 Which of the following is equal to $3\frac{5}{6}$?

- (1) $\frac{15}{6}$
(2) $\frac{21}{6}$
(3) $\frac{23}{6}$
(4) $\frac{35}{6}$

7 $52.94 = 50 + 2 + \frac{90}{\boxed{?}} + \frac{4}{100}$

What is the missing number in the box?

- (1) 1
(2) 10
(3) 100
(4) 1000

8 In a hall, $\frac{3}{8}$ of the number of students are girls. What is the ratio of the number of boys to the number of girls in the hall?

- (1) 3 : 11
- (2) 5 : 3
- (3) 5 : 8
- (4) 5 : 11

9 What is the area of triangle ABC?

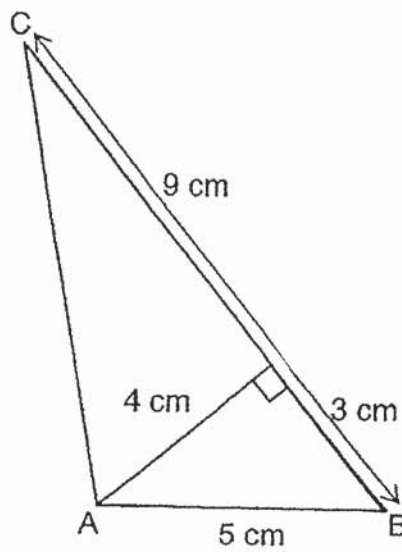

- (1) 24 cm²
- (2) 30 cm²
- (3) 48 cm²
- (4) 60 cm²

10 What is the volume of the cuboid shown below?

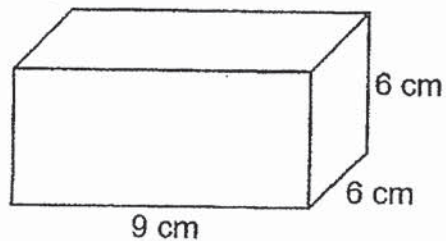

- (1) 216 cm³
- (2) 324 cm³
- (3) 486 cm³
- (4) 729 cm³

11 Ms Lee paid \$240 for a bag and a skirt. The bag cost 4 times as much as the skirt. How much more did the bag cost than the skirt?

- (1) \$144
- (2) \$120
- (3) \$96
- (4) \$48

12 There were 16 pupils in a class at first. 12 of them were girls. 2 more boys and 2 more girls joined the class. In the end, what fraction of the pupils in the class were girls?

- (1) $\frac{2}{3}$
- (2) $\frac{7}{8}$
- (3) $\frac{7}{9}$
- (4) $\frac{7}{10}$

13 What is the value of $7 + 3 \times 6 - 4$?

- (1) 56
- (2) 21
- (3) 20
- (4) 13

- 14 The diagram below shows a triangle XYZ drawn inside a box.

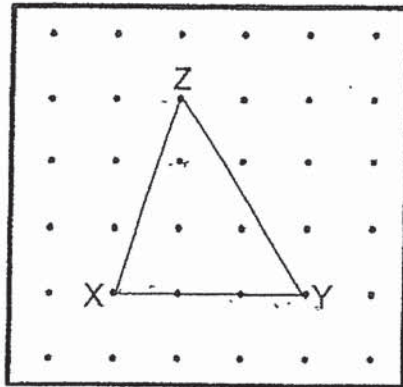

Which of the following triangles has the same area as triangle XYZ above?

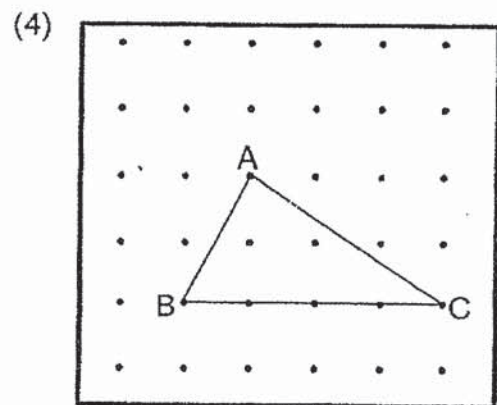
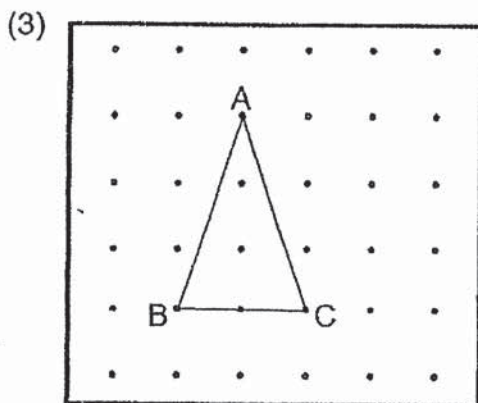
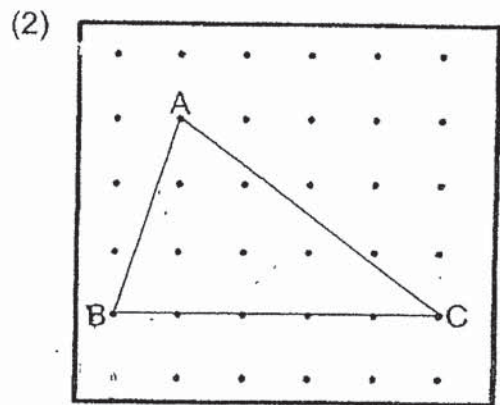
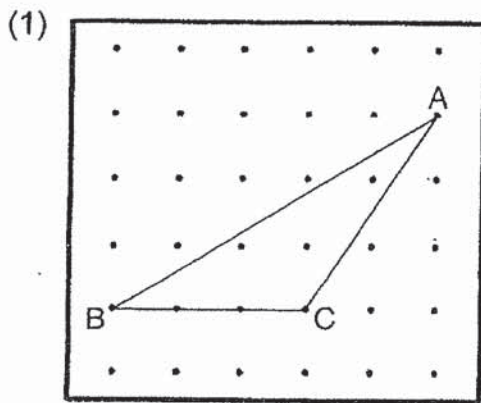

- 15 The figure below is made up of identical rectangles. How many white rectangles must be removed so that $\frac{2}{5}$ of the figure is shaded?

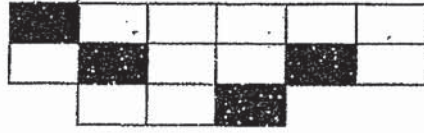

- (1) 1
- (2) 2
- (3) 5
- (4) 6

(Go on to Booklet B)

Questions **16** to **20** carry 1 mark each. Write your answers in the spaces provided. For questions which require units, give your answers in the units stated. (5 marks)

Do not write in this space

16 What is the missing number in the number pattern shown below?

611 899, _____, 612 099, 612 199, 612 299, 612 399

Ans: _____

17 Find the value of $4\frac{2}{5} + 1\frac{9}{10}$

Ans: _____

18 Express 0.06 as a fraction. Give your answer in its simplest form.

Ans: _____

(Go on to the next page)

- 19 In the triangle below, BCD is a straight line and $AB = BC$. What is the area of the triangle ACD?

Do not write in this space

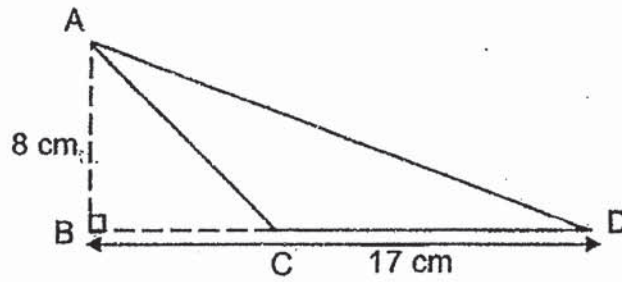

Ans: _____ cm^2

- 20 The solid below is made up of 1-cm cubes. What is the volume of the solid?

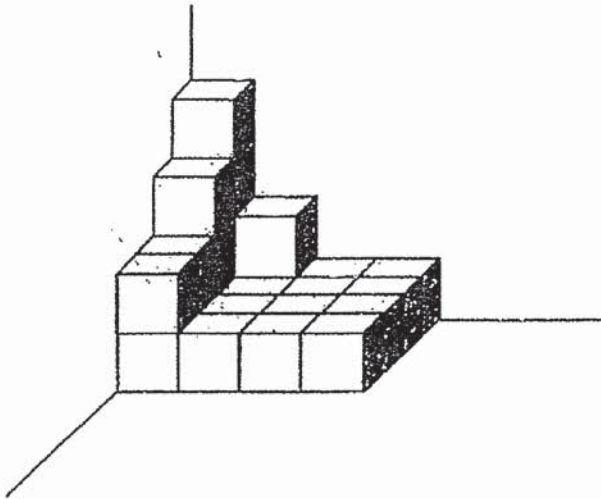

Ans: _____ cm^3

(Go on to the next page)

Questions 21 to 30 carry 2 marks each. Show your working clearly and write your answers in the spaces provided. For questions which require units, give your answers in the units stated.

(20 marks)

Do not write in
in this space

- 21 Mr Wong and Mrs Lee have a total of \$8776. Mr Wong has \$2388 more than Mrs Lee. How much does Mr Wong have?

Ans: \$ _____

- 22 List all the common multiples of 4 and 6 which are smaller than 30.

Ans: _____

- 23 $\frac{4}{9}$ of a number is 72. What is the number?

Ans: _____

(Go on to the next page)

- 24 Randy, Samy and Tann donated \$1152 in the ratio of 3 : 2 : 4 respectively. How much did Tann donate?

Do not write
in this space

Ans: \$ _____

- 25 The figure below is made up of 5 identical triangles. What is the area of one such triangle?

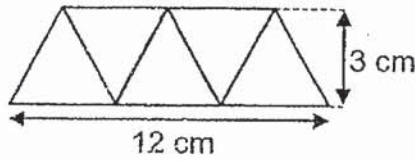

Ans: _____ cm²

- 26 Abigail had 414 packets of buttons. Each packet contained 6 buttons. She repacked the buttons into packets of 4. How many packets of 4 buttons would she get?

Ans: _____

(Go on to the next page)

Use the information below to answer Questions 27a and 27b.

The table below shows the schedule for a shuttle bus that leaves a hotel for a shopping mall.

Leaves hotel	Arrives at shopping mall
11 30	11 45
12 00	12 15
12 30	12 45
13 00	13 15
13 30	13 45
14 00	14 15

27a What is the latest time Ming Ming can take the shuttle bus to reach the shopping mall by 1 p.m.?

Ans: _____ p.m.

27b Li Li wants to take the shuttle bus that leaves at 11 30 but she is 25 minutes late. What is the earliest time she can arrive at the shopping mall, by taking the shuttle bus from the hotel?

Ans: _____ p.m.

28 Ali and Ben shared the total cost of a present.

Ali paid \$15 more than $\frac{3}{8}$ of the cost of the present. Ben paid \$25.

How much did the present cost?

Ans: \$ _____

Do not write
in this
space

- 29 A pole was 2 m long. Jack painted $\frac{1}{4}$ of the pole red, $\frac{2}{5}$ of the pole blue and the rest of it green. Find the length of the pole that was painted green. Express your answer in cm.

Do not write
in this space

Ans: _____ cm

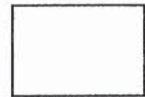

- 30 The figure shows a rectangular glass box partly filled with unit cubes. Jim then completely filled the box with unit cubes. How many such unit cubes were there altogether in the end?

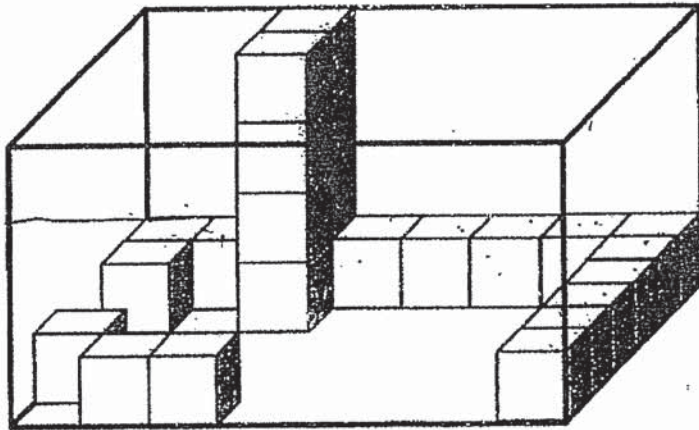

Ans: _____

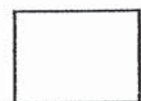

End of Paper 1

Questions 1 to 5 carry 2 marks each. Show your working clearly and write your answers in the spaces provided. For questions which require units, give your answers in the units stated.

(10 marks)

Do not write in this space

- 1 The ratio of the number of adults to the number of children at the zoo was 2 : 1. There were 885 boys and 637 girls at the zoo. Altogether, how many people were at the zoo?

Ans: _____

- 2 John wrote a decimal. He wanted to multiply it by 4. Instead, he multiplied it by 7 and the answer was 1.05. What should have been the correct answer?

Ans: _____

(Go on to the next page)

- 3 Mr Lee wants to fence his rectangular farm measuring 550 m by 350 m. The fence costs \$15 per metre. How much does he have to pay in total to fence his rectangular farm?

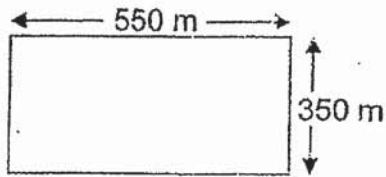

Do not
write in
this
space

Ans: \$ _____

- 4 Joe had \$4315 more than Kim at first. Then, Kim gave Joe \$268. How much more money did Joe have than Kim in the end?

Ans: \$ _____

(Go on to the next page)

- 5 Study the following solid. Draw its front view and side view on the square grids below.

Do not write in this space

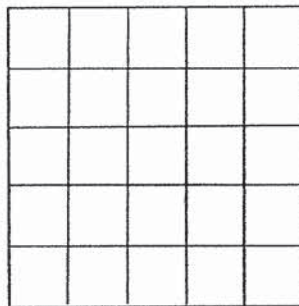
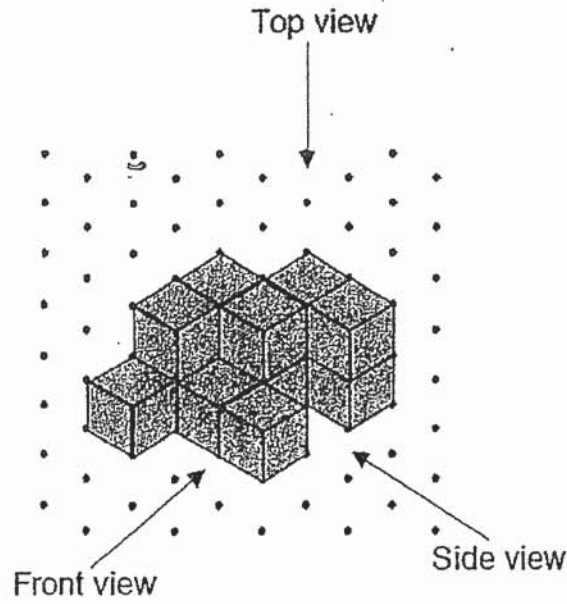

Front View

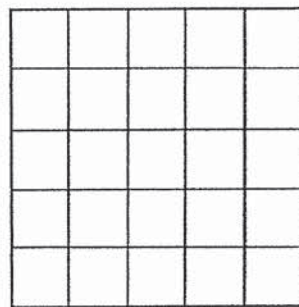

Side View

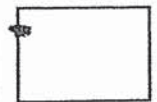

(Go on to the next page)

For questions 6 to 17, show your working clearly and write your answers in the spaces provided. The number of marks available is shown in brackets [] at the end of each question and part-question.

(45 marks)

Do not
write in
this
space

- 6 In a class, $\frac{3}{5}$ of the pupils are girls. $\frac{1}{6}$ of the girls and $\frac{3}{4}$ of the boys wear spectacles. What fraction of the pupils wear spectacles? Express your answer in its simplest form.

Ans: _____ [3]

- 7 In a crate, $\frac{2}{5}$ of the fruits were apples and the rest were pears. $\frac{1}{2}$ of the apples and 74 pears from the crate were sold. There were then a total of 150 apples and pears left in the crate. What was the total number of apples and pears in the crate at first?

Ans: _____ [3]

(Go on to the next page)

- 8 The figure below shows square ABEF and rectangle BCDE. Find the sum of $\angle x$ and $\angle y$.

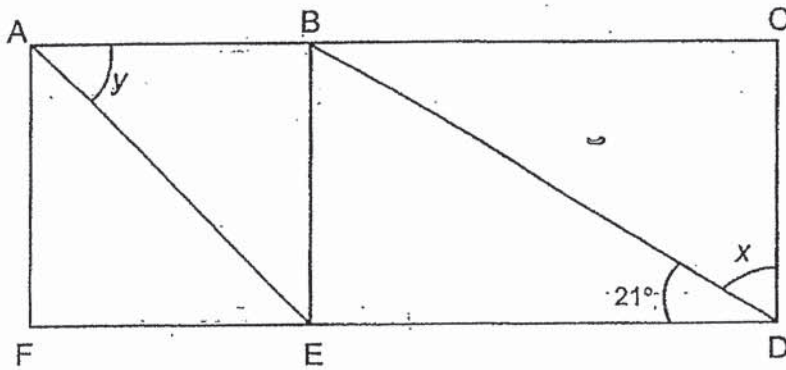

Do not
write in
this
space

Ans: _____ [3]

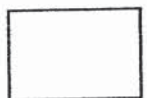

(Go on to the next page)

- 9 The bar graph below shows the favourite colours of all the students in a school. Each student was only allowed to choose 1 favourite colour.

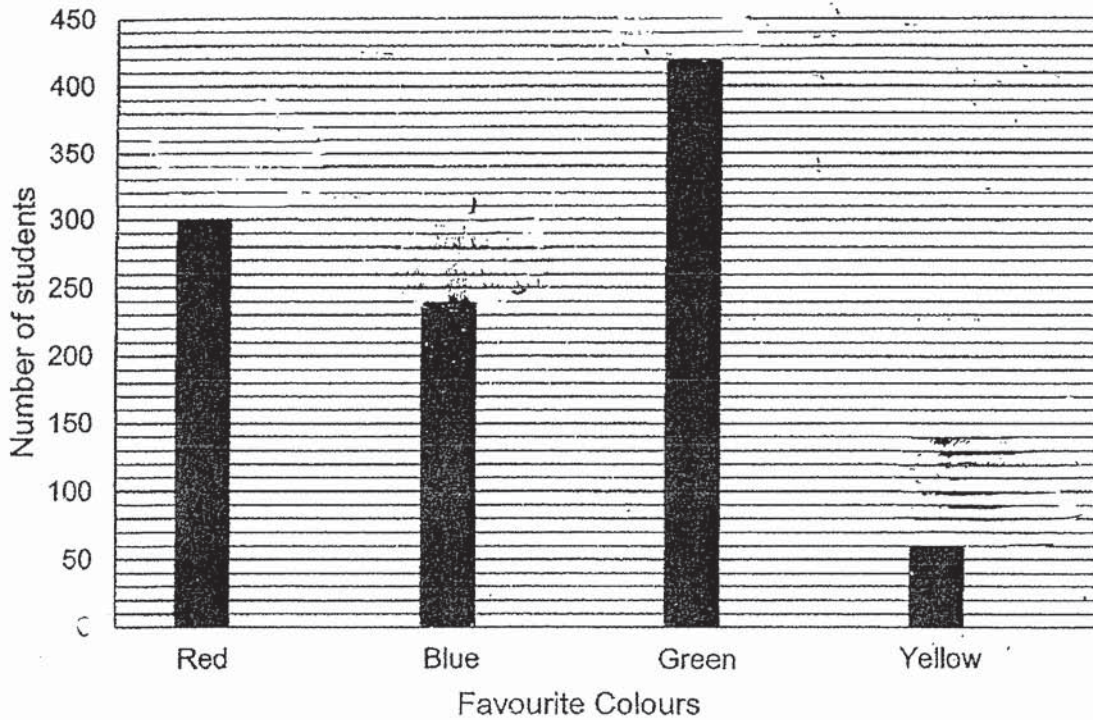

Do not write in this space

- (a) What is the ratio of the number of students who chose red to the number who chose blue to the number who chose yellow?
- (b) Mr Tan bought T-shirts for all the students in the school in their favourite colours. The total amount collected from the sales of T-shirts was \$10 710. Given that the cost of each T-shirt was the same, find the cost of each T-shirt.

Ans: (a) _____ [1]

(b) _____ [2]

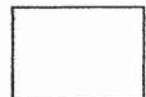

(Go on to the next page)

- 10 744 girls and 1498 boys signed up for a Mathematics competition. On the actual day of the competition, some boys were absent. As a result, the ratio of the number of girls to the number of boys taking part in the competition was 6 : 11. How many boys were absent for the competition?

Do not write in this space

Ans: _____ [4]

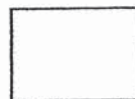

- 11 Jake and Kim had a total of \$3139 at first. After Jake spent \$254 and Kim spent \$185, Jake had 4 times as much money as Kim had left. How much money did Jake have at first?

Do not
write in
this
space

Ans: _____ [5]

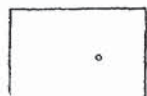

(Go on to the next page)

12 The figure below shows a rectangular piece of paper with one of its corners folded.

Do not write in this space

(a) Find the area of the shaded triangle.

(b) The length of the paper is 23 cm and the breadth is 8 cm, ~~how many~~ such triangles can be cut from the piece paper? what is the greatest number of

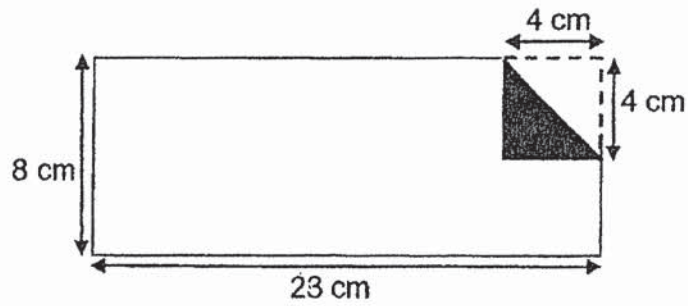

Ans: (a) _____ [1]

(b) _____ [4]

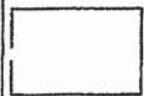

- 13 Ali and Ben had 213 stamps. Ali and Clement had 270 stamps. The ratio of the number of stamps Ben had to the number of stamps Clement had was 4 : 7. How many stamps did Ali have?

Do not write in this space

Ans: _____ [3]

- 14 The figure below is made up of 2 squares. Find the area of the shaded part.

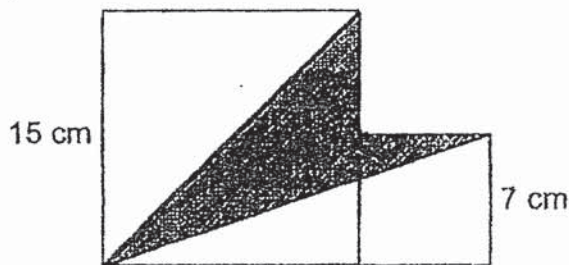

Ans: _____ [3]

(Go on to the next page)

- 15 A baker bought some eggs. She used $\frac{1}{3}$ of the eggs to bake tarts, 92 eggs to bake muffins and $\frac{2}{3}$ of the remaining eggs to bake cupcakes. After that, she still had 36 eggs. How many eggs did the baker buy?

Do not
write
this
space

Ans: _____ [4]

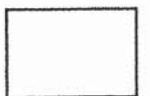

(Go on to the next page)

- 16 A rectangular tank measuring 150 cm by 70 cm by 85 cm high was $\frac{2}{5}$ -filled with water. Mrs Tan poured 12 pails of water, each containing the same volume of water, into the tank. In the end, there was 615 ℓ of water in the tank. What was the volume of water in each pail? Give your answer in litres.

Do not write in this space

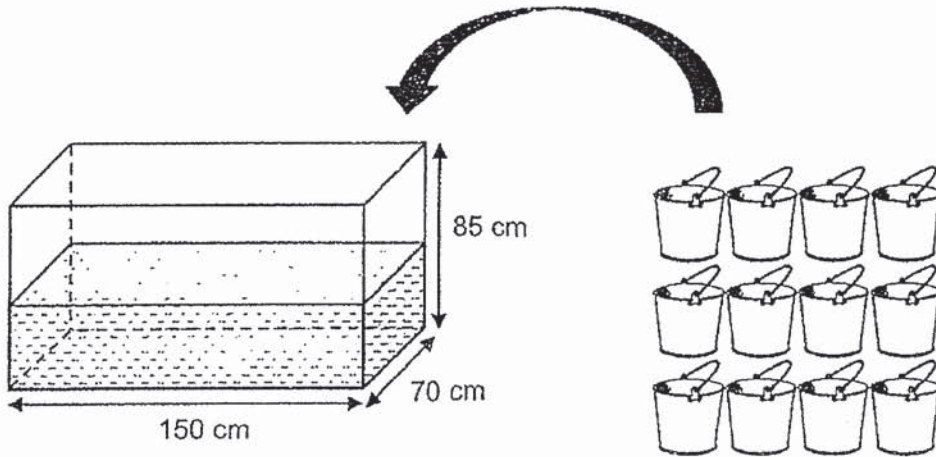

Ans: _____ [4]

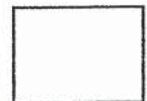

17. Mr Lau bought a tennis racket and a bag at discounted prices. He spent a total of \$168.75 on the two items. The ratio of the amount Mr Lau paid for the tennis racket to the amount he paid for the bag was 2 : 1.

Do not write
in this space

- (a) Find the cost of the bag after the discount.
- (b) The total discount given for the two items was \$31.25. Mr Lau was given a 10% discount for the tennis racket. What was the percentage discount given for the bag?

Ans: (a) _____ [1]

(b) _____ [4]

(Go on to the next page)

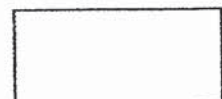

ANSWER KEY

YEAR : 2019
LEVEL : PRIMARY 5
SCHOOL : HENRY PARK PRIMARY SCHOOL
SUBJECT : MATHEMATICS
TERM : SA1

PAPER 1 : BOOKLET A

Q1	Q2	Q3	Q4	Q5	Q6	Q7	Q8
4	2	3	2	3	3	3	2
Q9	Q10	Q11	Q12	Q13	Q14	Q15	
1	2	1	4	2	1	3	

Q16	611999
Q17	$4\frac{4}{10} + 1\frac{9}{10} = 6\frac{3}{10}$
Q18	$\frac{3}{50}$
Q19	$17 - 8 = 9\text{cm}$ $\frac{1}{2} \times 8 \times 9 = 36\text{cm}^2$
Q20	24cm^3
Q21	$8776 - 2388 = \$6388$ $\$6388 \div 2 = \3194 $\$3194 + \$2388 = \$5582$
Q22	12 and 24
Q23	162
Q24	$\$1152 \div 9 = \128 $\$128 \times 4 = \512
Q25	$\frac{1}{2} \times 4 \times 3 = 6\text{cm}^2$
Q26	$114 \times 6 \div 4 = 621\text{packets}$
Q27a	9 p.m.
Q27b	5 p.m.
Q28	$\$25 + \$15 = \$40$ $5u \rightarrow \$40$ $u \rightarrow \$8$ $8u \rightarrow \$64$
Q29	$1 - \frac{1}{4} - \frac{2}{5} = \frac{20}{20} - \frac{5}{20} - \frac{8}{20}$ $= \frac{7}{20}$ $2m = 200\text{cm}$ $200\text{cm} \times \frac{7}{20} = 70\text{cm}$
Q30	$4 \times 6 \times 8 = 192\text{ cubes}$

PAPER 2

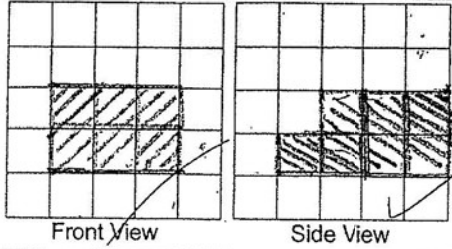
Q1	$885 + 637 = 1522$ $1u \rightarrow 1522$ $3u \rightarrow 4566 \text{ people}$
Q2	$1.05 \div 7 = 0.15$ $0.15 \times 4 = 0.6$
Q3	$(550 + 350) \times 2 = 1800$ $1800 \times \$15 = \27000
Q4	$2 \times \$268 = \536 $\$4315 + \$536 = \$4851$
Q5	 <p>Front View Side View</p>
Q6	$G : B : T \rightarrow 3 : 2 : 5 \rightarrow 6 : 4 : 10$ $\frac{1}{10} + \frac{3}{10} = \frac{4}{10} = \frac{2}{5}$
Q7	<p>At first $\rightarrow A : P = 2u : 3u$ In the end $\rightarrow A : P = 1u : 3u - 74$ $1u + 3u - 74 = 150$ $4u = 150 + 74 = 224$ $1u = 56$ $5u = 56 \times 5 = 280$</p>
Q8	$\angle x = 90 - 21 = 69$ $\angle y = 90 - 45 = 45$ $\angle x + \angle y = 69 + 45 = 114$
Q9	<p>(a) $R : B : Y \rightarrow 300 : 240 : 60 \rightarrow 5 : 4 : 1$ (b) $300 + 240 + 420 + 60 = 1020$ $\\$10710 \div 1020 = \\10.50</p>
Q10	$744 \div 6 = 124$ $124 \times 11 = 1364$ $\quad - 1364 = 134$
Q11	$\quad - \$185 - \$254 = \$2700$ $\$2700 \div 5 = \540 $\$540 \times 4 + 254 = \2414
Q12	<p>(a) $\frac{1}{2} \times 4 \times 4 = 8 \text{ cm}^2$ (b) $8 \div 4 = 2$ $23 \div 4 = 5 \text{ R } 3$ $5 \times 2 \times 2 = 20 \text{ triangles can be cut}$</p>
Q13	$7 - 4 = 3u$ $3u \rightarrow 270 - 213 = 57$ $4u \rightarrow 57 \div 3 \times 4 = 76$ Ali : $213 - 76 = 137 \text{ stamps (Ali have)}$

Q14	<p>Length of base $\rightarrow 7 + 15 = 22$</p> <p>Total area $\rightarrow 15 \times 15 + 7 \times 7 = 225 + 49 = 274$</p> <p>Unshaded part $\rightarrow (\frac{1}{2} \times 15 \times 15) + (\frac{1}{2} \times 7 \times 22) = 112.5 + 77 = 194.5$</p> <p>Total shaded area $\rightarrow 274 - 194.5 = 84.5\text{cm}^2$</p>
Q15	<p>$36 \times 3 = 108$</p> <p>$108 + 92 = 200$</p> <p>$200 \div 2 \times 3 = 300$</p>
Q16	<p>$85 \times \frac{2}{5} = 34$</p> <p>$34 \times 70 \times 150 = 357000\text{ml}$</p> <p>$357000\text{ml} = 357\text{L}$</p> <p>$615 - 357 = 258\text{L}$</p> <p>$258\text{L} \div 12 = 21.5\text{L}$ for each pail</p>
Q17	<p>(a) $\\$168 \div 3 = \\56.25</p> <p>(b) $\\$56.25 \times 2 = \\112.50</p> <p>$\\$112.50 \div 9 = \\12.50</p> <p>$\\$31.25 - \\$12.50 = \\$18.75$</p> <p>$\\$18.75 + \\$56.25 = \\75</p> <p>$\\$18.75 \div \\$75.00 = 0.25$</p> <p>$0.25 \approx 25\%$</p>