

RIVER VALLEY PRIMARY SCHOOL
SEMESTRAL ASSESSMENT 2 / 2017
PRIMARY 5

STANDARD SCIENCE

(BOOKLET A)

Name: _____ ()

Date : 31 Oct 2017

Class : P5 _____

Total Time for Booklet A & Booklet B : 1 hour 45 min



INSTRUCTIONS TO CANDIDATES

1. Write your name, index number and class in the space above.
2. Do not turn over this page until you are told to do so. Follow all instructions carefully.
3. Answer all questions.
4. For Section A, shade your answers for questions 1 to 28 in the Optical Answer Sheet (OAS).
5. For Section B, write your answers for questions 29 to 40 in the space provided in Booklet B.
6. The total marks for Booklet A is 56 marks.

Section A (56 marks)

For each question from 1 to 28, four options are given. One of them is the correct answer. Make your choice (1, 2, 3 or 4). Shade your answer on the Optical Answer Sheet (OAS).

1. Study the organisms below carefully.

Group X	Group Y
 bread mould	 turtle

Which of the following about Groups X and Y is correct?







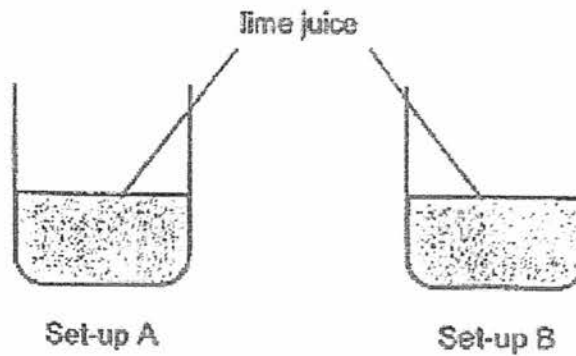

- A. Group X grows but Group Y does not.
- B. Group X makes its own food but Group Y does not.
- C. Group X reproduces by spores but Group Y does not.
- D. Group X needs air, food and water but Group Y does not.

- (1) A
- (2) B
- (3) C
- (4) D

2. Sulaiman conducted an experiment to find out if the size of food affects how fast digestion takes place. He sets up 2 identical beakers, A and B, containing the same amount of lime juice.



Which of the following food sizes should he use for the set-ups?

	Set-up A	Set-up B
(1)		
(2)		
(3)		
(4)		

3. The pictures below shows commuters in a train during peak hours.

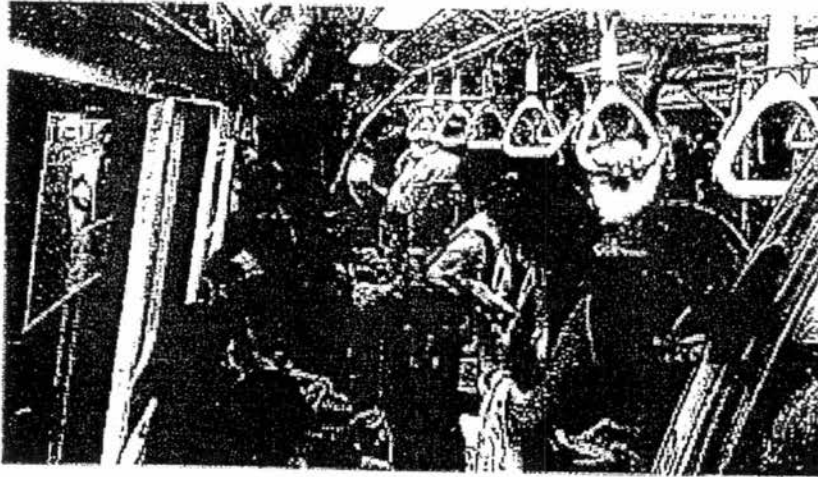

A few commuters complained of having difficulties in breathing and felt uncomfortable.

What could be the possible changes in the composition of air in the train which led to their discomfort?

	Nitrogen	Oxygen	Carbon dioxide	Water Vapour
(1)	Increase	Decrease	Increase	Remain the same
(2)	Decrease	Increase	Decrease	Remain the same
(3)	Remain the same	Increase	Decrease	Decrease
(4)	Remain the same	Decrease	Increase	Increase

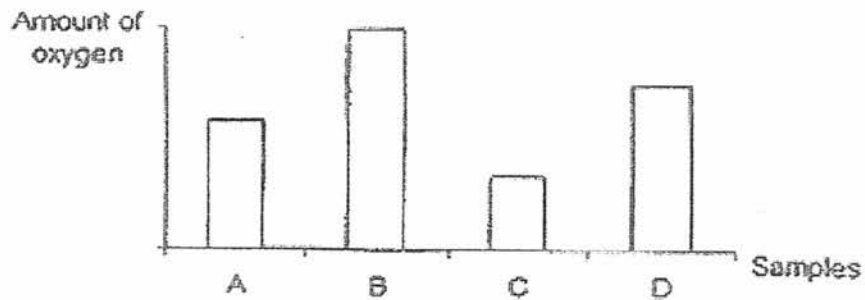

4. Four blood samples, A, B, C and D, were taken from different blood vessels in the human body. The graph below shows the amount of oxygen in each of the blood samples.



Which blood sample (A, B, C or D) was most likely taken from blood going from the heart to the lungs?

- (1) A
- (2) B
- (3) C
- (4) D

5. Desmond put four glass jars A, B, C and D containing six similar seeds in as shown below. After a few days, he observed the seeds.

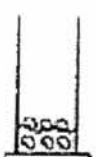
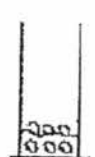
	Jar A	Jar B	Jar C	Jar D
				
cotton wool	Damp	Damp	Damp	Dry
Location	In the freezer	Near a window	In a dark room	In the garden

In which jars would he most likely be able to see the growth of seedlings?

- (1) Jar A and Jar B only
- (2) Jar B and Jar C only
- (3) Jar B and Jar D only
- (4) Jar A, Jar B and Jar C only

6. Farmer John found many organism X on his fruit trees. He decided to leave them to develop to the next stage. Why is that so?

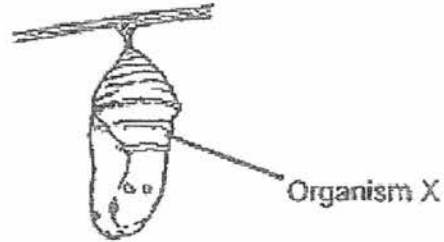

- (1) It is a pest and it is too many to remove.
- (2) It has stopped feeding so it will not destroy his trees.
- (3) It does not need air to survive so it will not compete for oxygen.
- (4) It can reproduce at this stage so they can help in pollination.

7. Shufen placed a balsam plant into a beaker with 300 ml of water. She added a layer of oil on the water. After three days, she observed that the leaves and flowers began to wither. The water level remained at 300ml.

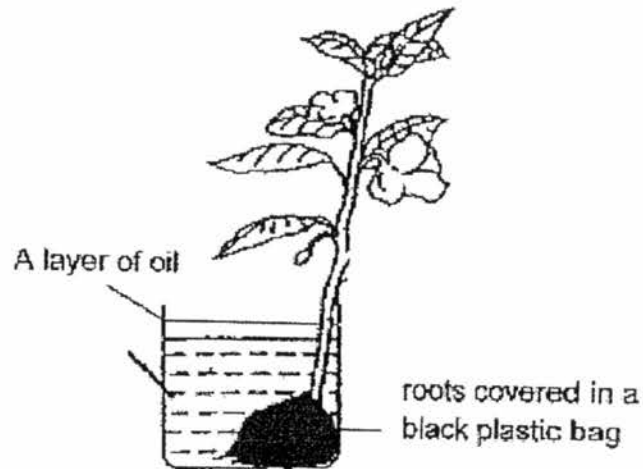

This experiment shows that plants _____

- (1) need air
- (2) reproduce
- (3) need water to survive
- (4) can make their own food

8. The flowchart below shows the characteristics of four organisms, A, B, C and D.

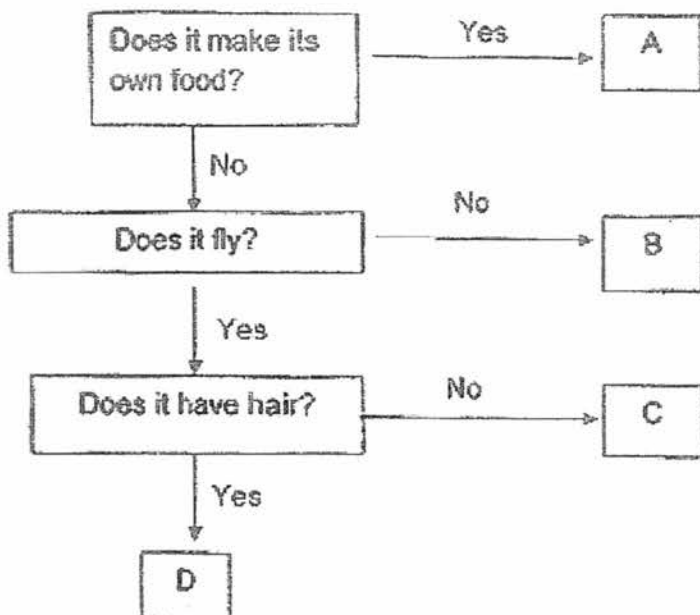

Based on the flowchart above, what could organisms A, B, C and D be?

	A	B	C	D
(1)	Fern	Mushroom	Bird	Mammal
(2)	Fungi	Bird	Butterfly	Mammal
(3)	Fern	Yeast	Fish	Butterfly
(4)	Fungi	Mammal	Grasshopper	Bird

9. Alicia observed three cells, A, B and C, under the microscope and recorded her results in the table below.

Parts of cell	Cell A	Cell B	Cell C
Nucleus	✓	✓	✓
Cell Wall	X	✓	✓
Cytoplasm	✓	✓	✓
Chloroplast	X	X	✓

Based on her observations, Alicia then classified the cells (A, B and C) into animal cells and plant cells. Which of the following shows the correct classification?

	Animal Cell	Plant Cell
(1)	A	B and C
(2)	B	A and C
(3)	A and C	B
(4)	A and B	C

10. The diagram below shows Cell X.

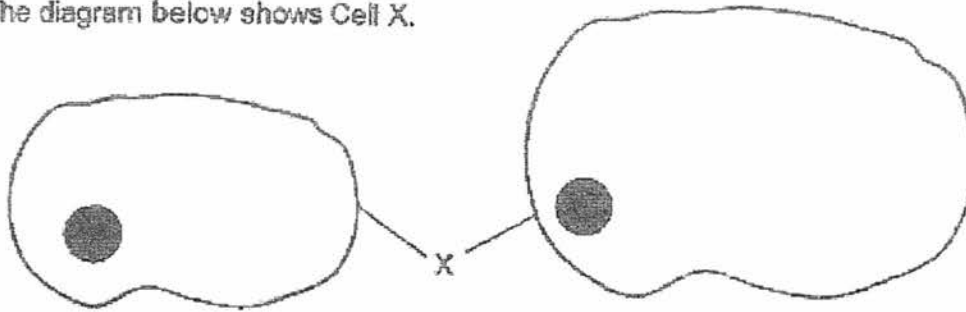

Cell X swelled after it has been placed in water

A group of students placed Cell X in water. After a while, it swelled.

The students then concluded that Cell X swelled because the _____ allowed water to enter,

- A. cell wall
- B. nucleus
- C. cytoplasm
- D. cell membrane

Which of the following are correct?

- (1) A and B only
- (2) A and C only
- (3) B and C only
- (4) B and D only

11. Two islands P and Q were located beside each other. No one lived on those islands. In Island P, four different types of plants were found but none of these plants were found in Island Q.

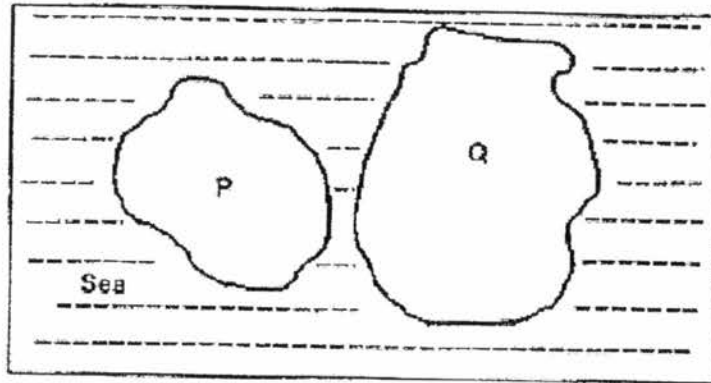

The characteristics of the four fruits are shown in the table below.

Plant	Characteristic of fruit
A	Fibrous husk
B	Dry fruit wall
C	Fleshy and juicy
D	Soft hair-like structures

After some time, some of the plants were found to be growing on Island Q. Which plants were most likely to be growing on Island Q?

- (1) A and C only
- (2) A and B only
- (3) A, C and D only
- (4) B, C and D only

12. Plant Z has male and female reproductive parts growing on separate flowers

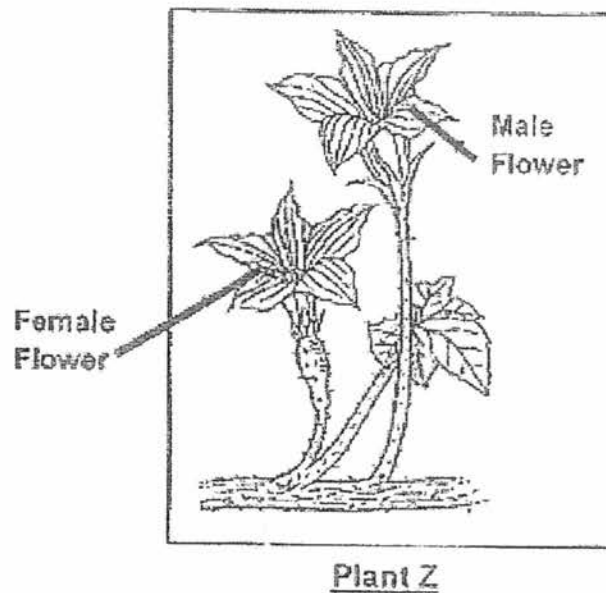

The male flowers are observed to have grown taller than the female flowers.

Which of the following can be a possible reason for the male flower growing taller than the female flower?

- (1) This allows the stigma to grow towards the anther.
- (2) This allows the anther to be easily carried away by wind.
- (3) This allows the insects to reach the stigma easily for pollination.
- (4) This allows pollen grains from the anther to fall onto the stigma easily.

13. The diagram below shows the male and female human reproductive system.

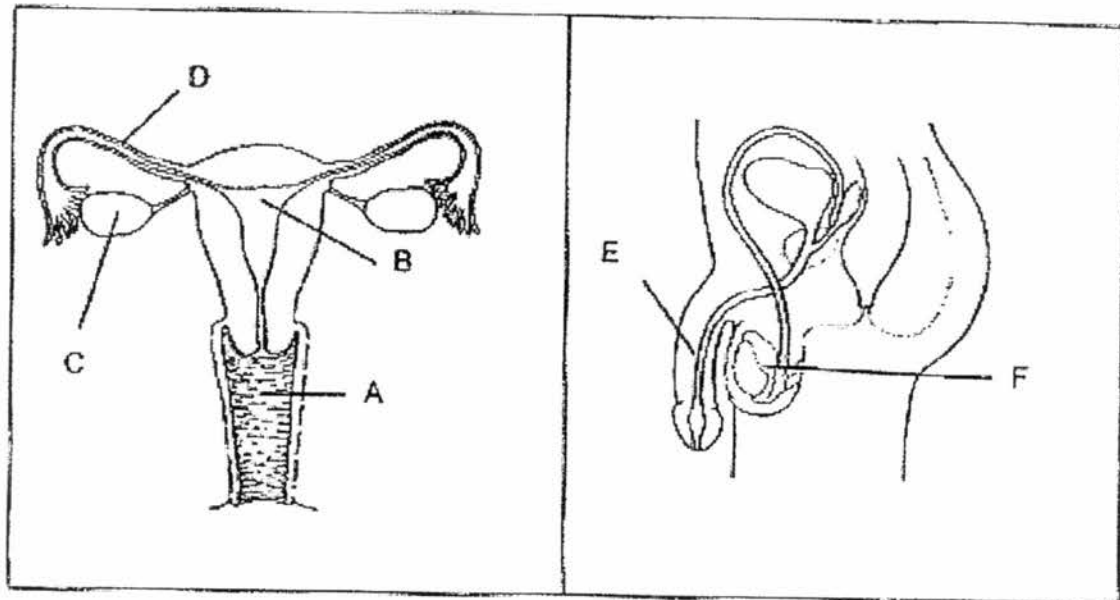

Based on the above illustration, how does sperm travel to allow fertilisation to take place?

- (1) C → D → B → A → E
- (2) D → B → A → E → F
- (3) E → A → B → D → C
- (4) F → E → A → B → D

14. Abigail conducted an experiment using a beaker of water to observe how heat was gained and lost. She measured the temperature of the water at various times as shown below.

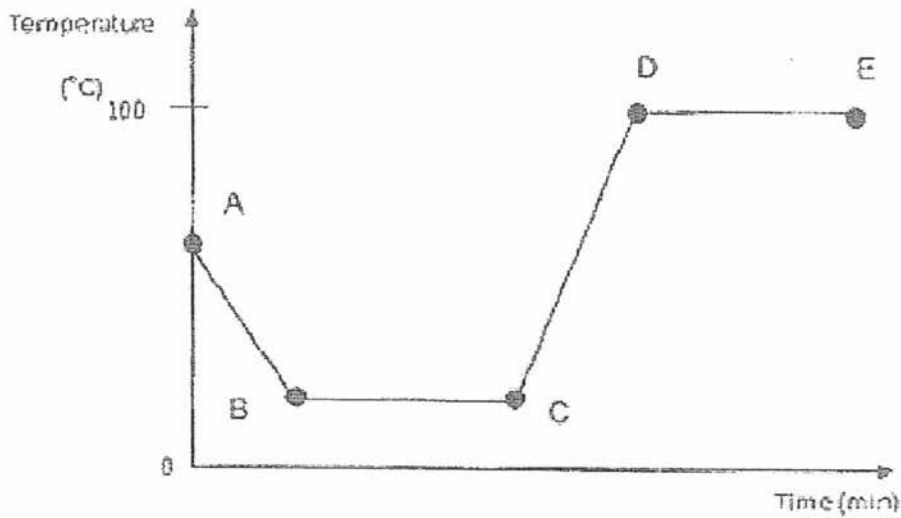

Which of the following describes the changes taking place in the beaker during the experiment?

(1)	A to B	Some ice cubes were added into the beaker.
(2)	B to C	A lighted candle is placed beside the beaker.
(3)	C to D	The beaker of water is placed in the freezer.
(4)	D to E	More water at 80°C is added into the beaker.

15. "Rainwater Harvesting" systems as shown below are commonly used in some places for residents to conserve water in their homes.

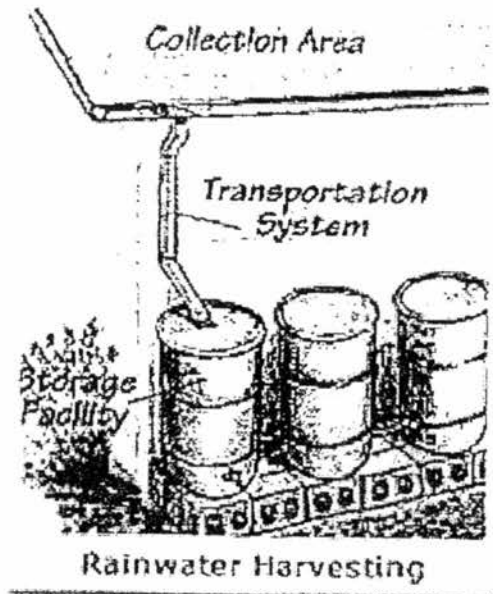

How can residents improve the system so that they can conserve more water?

A: Make the Collection Area bigger

B: Repair leaks in the Storage Facility tanks

C: Build one more pipe in the Transportation System

- (1) A and B
- (2) A and C
- (3) B and C
- (4) A, B and C

16. The diagram below shows a set-up that represents the water cycle.

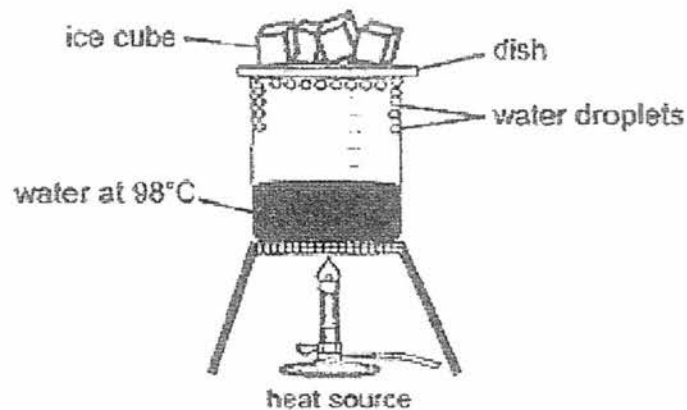

Three
Four students made the following statements on the objects used in the set-up.

Amy: The ice cubes melted to form water droplets.

Bella: The dish prevents water vapour from escaping.

Cliff: The heat source represents the Sun in the water cycle.

Whose statement(s) is/are correct?

- (1) Amy only
- (2) Bella and Cliff only
- (3) Amy and Bella only
- (4) Amy, Bella and Cliff

17. The table below shows the state of four different substances, A, B, C and D, at different temperatures.

Substance	State of substance at 20°C	State of substance at 50°C	State of substance at 90°C
A	Gas	Gas	Gas
B	Solid	Solid	Liquid
C	Liquid	Liquid	Gas
D	Solid	Liquid	Liquid

Which substance has the lowest melting point?

- (1) A
- (2) B
- (3) C
- (4) D

18. A drop of wax is placed on one end of four rods (A, B, C and D) respectively. Each rod is made of a different material. The other end of each rod is heated over a fire until the wax melts completely as shown in diagram A.

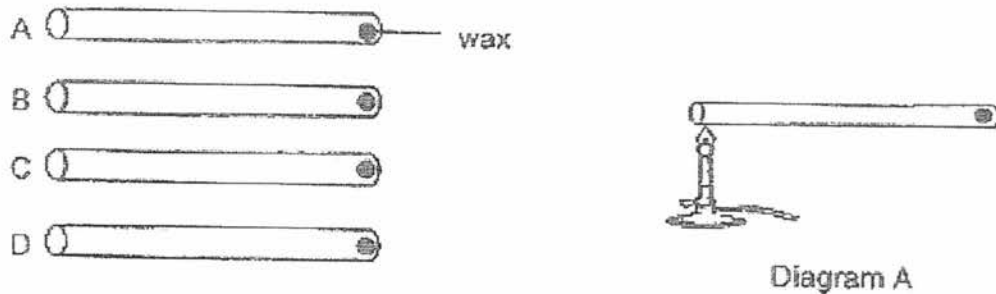

The time needed for the wax to melt is recorded in the table below.

Material	Time taken for wax to melt completely (seconds)
A	55
B	36
C	300
D	160

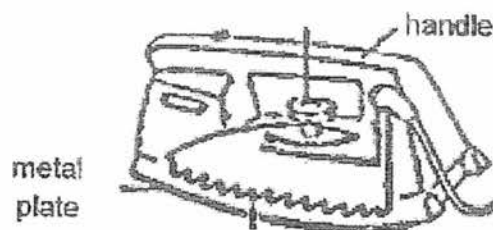

Based on the above results, which of the following materials is the most suitable to make the handle and metal plate?

	Handle	Metal plate
(1)	C	B
(2)	B	C
(3)	D	B
(4)	A	C

19. Four materials, E, F, G and H, were connected in the electrical circuit as shown below.

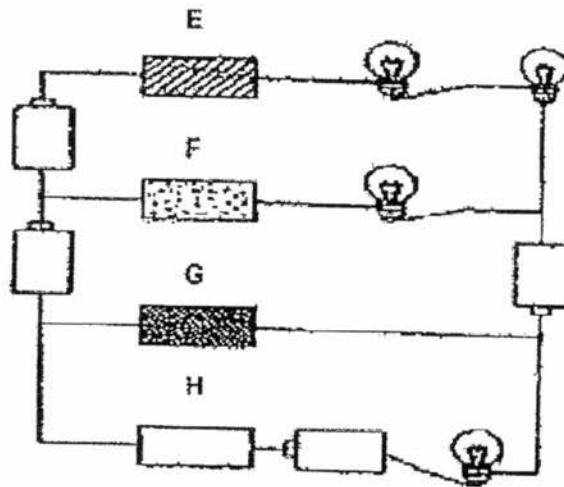

Which of the following correctly represents the materials E, F, G and H such that only two of the bulbs will light up?

	Material E	Material F	Material G	Material H
(1)	Plastic	Wood	Glass	Iron
(2)	Copper	Plastic	Steel	Glass
(3)	Iron	Copper	Steel	Plastic
(4)	Steel	Glass	Wood	Copper

20. Lisa wanted to find out if the size of the magnet affects the distance the paper clips are attracted.

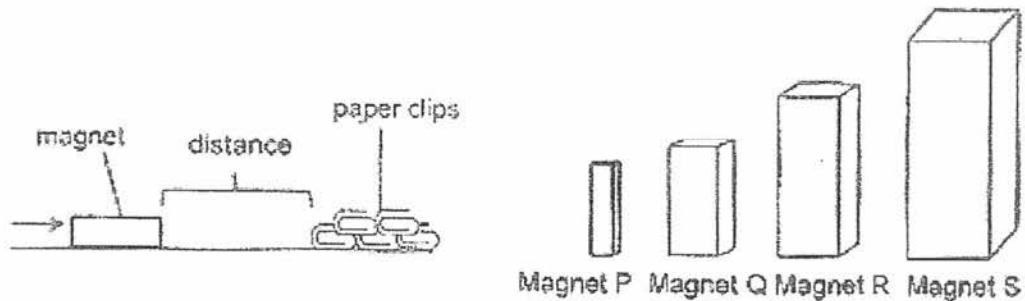

She plotted her results in the graph as shown below.

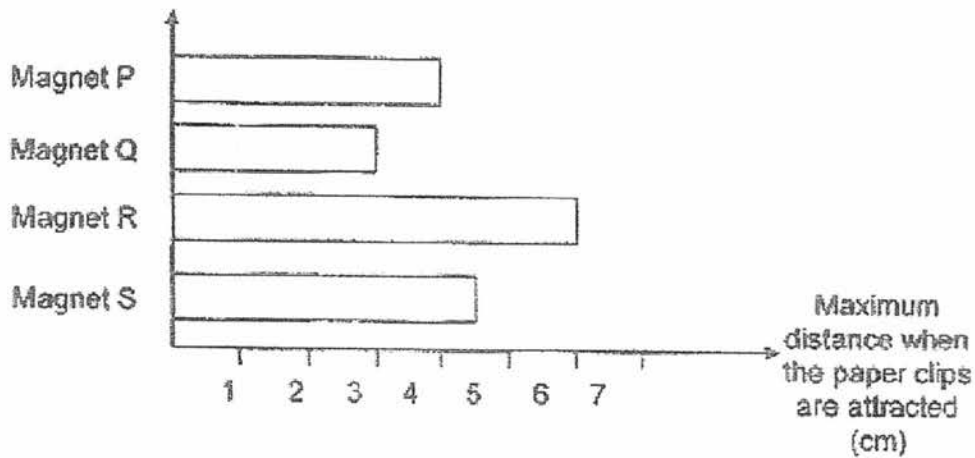

Based on the graph, which of the following statements are true?

- A: Magnet Q is not as strong as Magnet P.
- B: Magnet S is the strongest as it is the biggest.
- C: Magnet R can attract more paper clips than Magnet S.
- D: Magnet P is able to attract paper clips that are placed 4 cm away from it.

- (1) A only
- (2) B and C only
- (3) A, C and D only
- (4) B, C and D only

21. Aisha carried out an experiment using three metal bars, P, Q and R. She set up the electrical system as shown below.

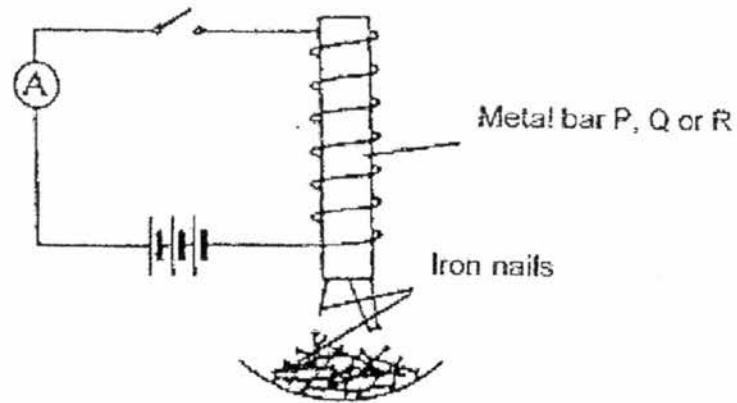

When she closed the switch, the metal bar was able to attract some iron nails. When the switch was opened, the nails dropped. She then recorded the results as shown below.

Metal bar	Number of nails attracted	Number of nails left on the metal bar
P	35	4
Q	20	5
R	40	3

What conclusions can Aisha draw from her results?

- (1) Metal P will make the best electromagnet.
- (2) Metal Q will make the best electromagnet.
- (3) Metal R will make the best electromagnet.
- (4) Metal Q will make the best permanent magnet.

22. Paul wanted to investigate if the distance between an object and the light sensor affects the reading of the light sensor. He prepared the set-up as shown below.

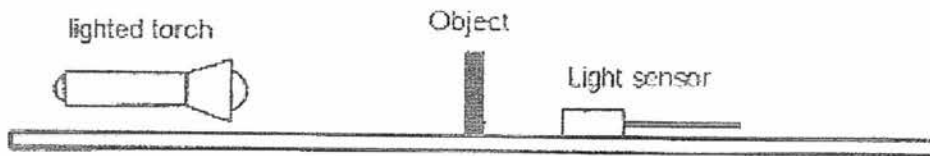

Which of the following variables should be kept constant to ensure a fair test?

- A: Material of the objects
- B: Amount of light from the torch
- C: Distance between the torch and the object
- D: Distance between the object and the light sensor

(1) A, B and C only

(2) A, B and D only

(3) A, C and D only

(4) B, C and D only

23. Zenn made a doll from a ball, a toothpick and a cone as shown below.

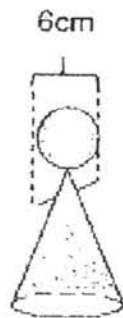

Which of the following shadow(s) could be formed when light is shone from all directions?



A



B



C



D

- (1) A only
- (2) A and B only
- (3) C and D only
- (4) A, C and D only

24. Jonathan conducted an experiment by placing a glass cube and an Iron cube of the same size at room temperature into a beaker of hot water as shown in the diagram below.

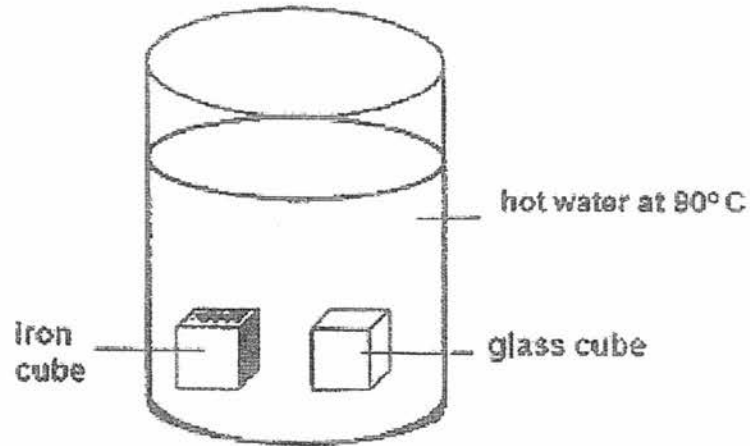

He then left the set-up on the table in the laboratory for 15 minutes.

What would be the most likely temperatures of the glass cube, iron cube and water at the end of the experiment?

Temperature (°C)			
	Iron cube	Glass cube	Water
(1)	65	35	25
(2)	55	35	75
(3)	45	45	75
(4)	35	45	65

25. Michaela set up an experiment using two beakers of water, A and B, of the same temperature. She placed the two beakers on a table in an air-conditioned room with the room temperature set at 20°C .

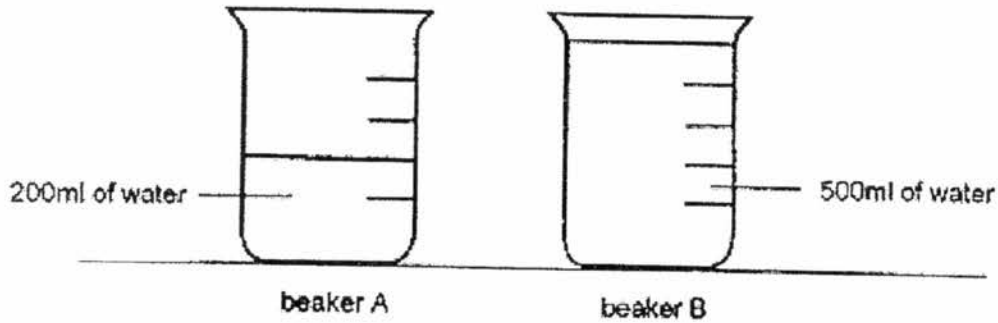

Which line graph shows the likely changes in the temperature of the water in the two beakers after some time?

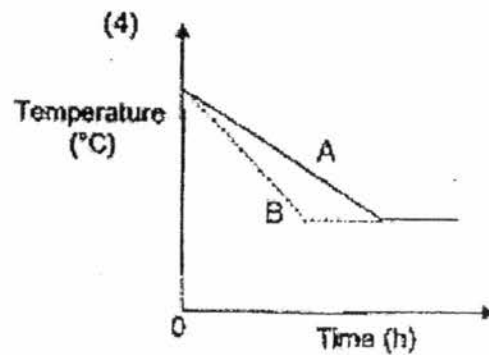
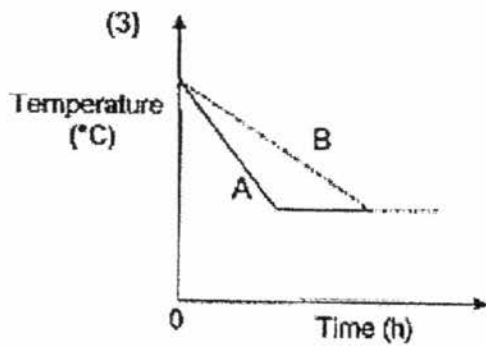
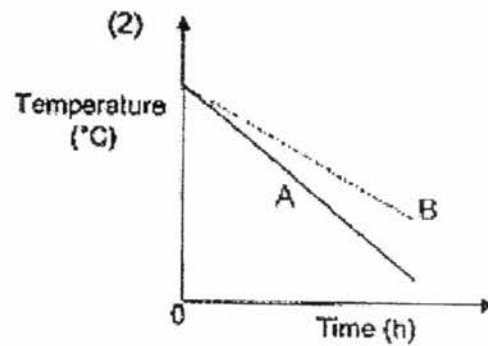
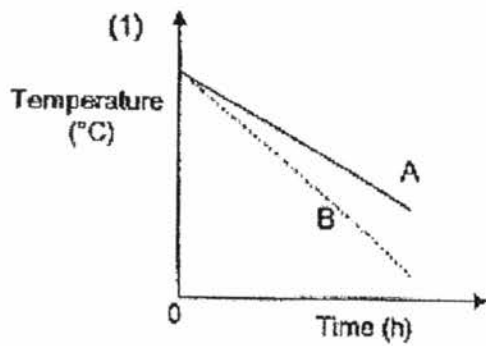

26. Jen constructed a circuit with four bulbs and two batteries. She covered the circuit with a piece of cardboard. The bulbs could be seen through the holes as shown below.

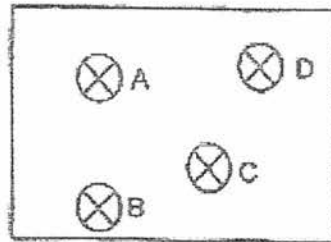

Jen removed bulbs A, B, C and D one at a time and observed the other three bulbs before connecting the bulb back into the circuit. She recorded her observations in the table below.

Bulb removed	A	B	C	D
Observations	B and C did not light up	A and D remained lit	A and D remained lit	A, B and C did not light up

Which of the following shows the circuit under the cardboard?

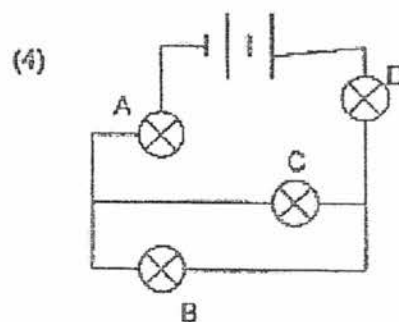
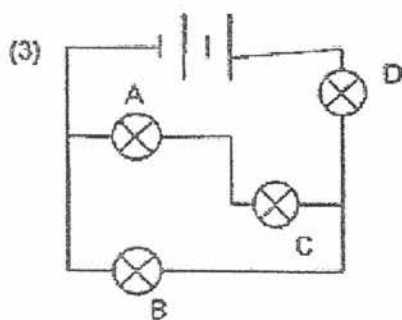
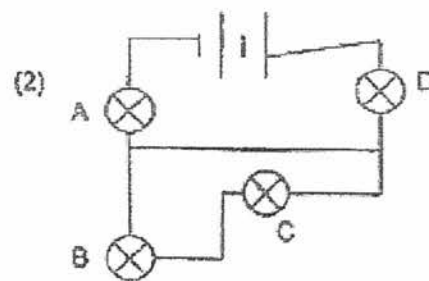
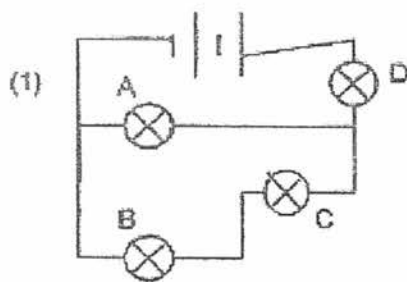

27. Mohan carried out an experiment to find out which objects, W, X, Y and Z, allow electricity to pass through. He connected each object to the same circuit one at a time. His results are shown in the table below.

Object	Light produced by bulb
W	Dim
X	None
Y	Very bright
Z	None

Which four objects were used in Mohan's experiment?

	W	X	Y	Z
(1)	Pencil lead	Plastic ruler	Steel clip	Glass slide
(2)	Glass slide	Steel clip	Pencil lead	Plastic ruler
(3)	Pencil lead	Glass slide	Steel clip	Iron nail
(4)	Steel clip	Iron nail	Plastic ruler	Pencil lead

28. The diagram below shows two school players, John and Anna. John hits the ball over the net and Anna is ready to hit the ball with more force.

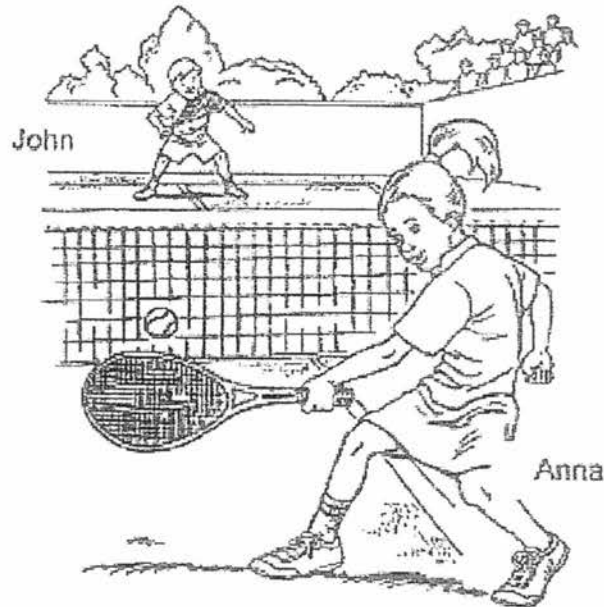

Which of the following statements are true after Anna hits the ball?

- A: The size of the ball changes.
 - B: The mass of the ball increases.
 - C: The speed of the ball increases.
 - D: The direction of the ball changes.
- (1) A and B only
(2) A and C only
(3) B and C only
(4) C and D only

~End of Section A~

RIVER VALLEY PRIMARY SCHOOL
SEMESTRAL ASSESSMENT 2 / 2017
PRIMARY 5

STANDARD SCIENCE

(BOOKLET B)

Name : _____ ()

Date : 31 Oct 2017

Class : P5 _____

Total Time for Booklet A & Booklet B : 1 hour 45 min

INSTRUCTIONS TO CANDIDATES

1. Write your name, index number and class in the space above.
2. Do not turn over this page until you are told to do so. Follow all instructions carefully.
3. Answer all questions.
4. For Section A, shade your answers for questions 1 to 28 in the Optical Answer Sheet (OAS).
5. For Section B, write your answers for questions 29 to 40 in the space provided in Booklet B.
6. The total marks for Booklet B is 44 marks.

Booklet A		/58
Booklet B		/44
Total		/100
Parent's Signature		

Section B (44 marks)

For questions 29 to 40, write your answers in this booklet.

29. The diagram below shows a cell of Organism Y.



(a) Scientists made some changes to the cell of Organism Y. The changes should allow the cell to:

- have a fixed body shape, and
- make its own food when there is light.

Draw and label the changes made to the cell in the box below. [2m]

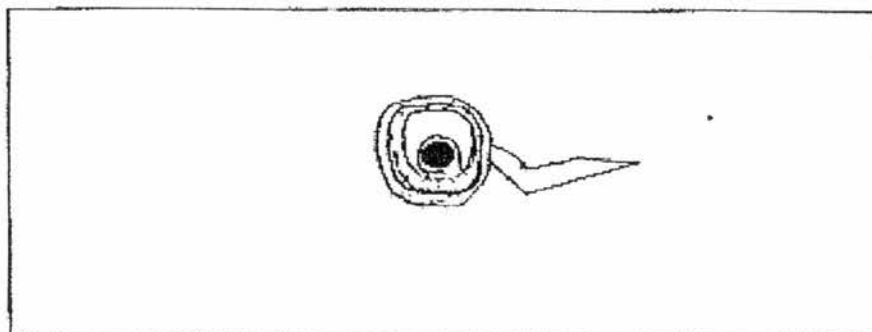

(b) Scientists also remarked that the tail-like structure of the cell would help Organism Y to survive better. Name 2 ways it would help Organism Y in its survival. [1m]

	3
--	---

30. Natasha saw two different Flowers, X and Y, in the garden.

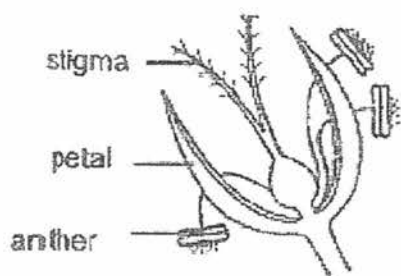

Flower X

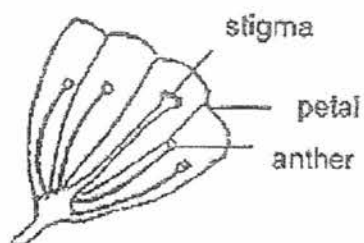

Flower Y

- (a) Based on the above diagram, how is Flower X likely to be pollinated? Explain your answer. [2m]

- (b) Flower Y has large and brightly coloured petals. How does having large and brightly coloured petals help Flower Y to pollinate? [2m]

	4
--	---

31. The diagram below shows the gills of a young and adult fish.

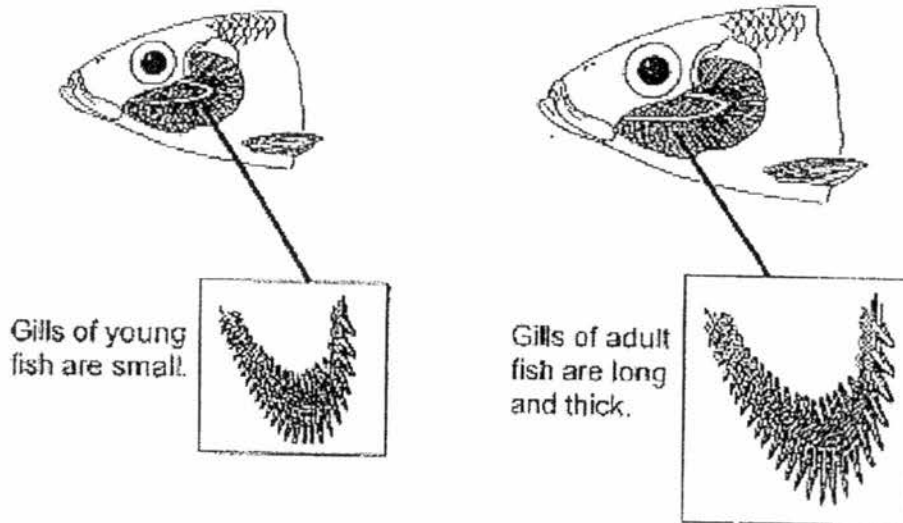

- (a) Based on the above diagram, explain why the adult fish can breathe more than the young. [1m]

The diagram below shows Fish C which can stay on land for a long period of time. When it is on land, it stores water in its gill chambers. After a while, it goes back to the water to get more water in its gill chambers before coming up to land again.

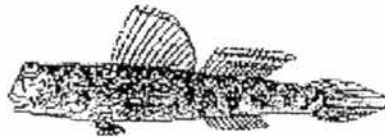

- (b) Why does Fish C get more water in its gill chambers before coming back to land again? [1m]

	2
--	---

32. The diagram below shows part of a plant. Some tubes were removed at different parts of the stem as shown below, and Leaf A and B were covered by different objects.

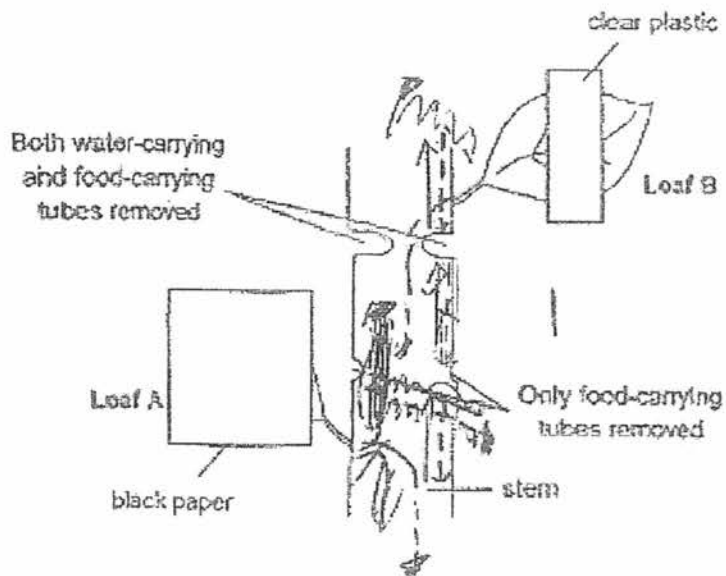

(a) If the food-carrying and water-carrying tubes had not been removed, draw arrow(s) in the diagram above to show the direction of the food and water in the plant: [1m]

Type of arrow to represent the direction of food: - - - - - →

Type of arrow to represent the direction of water: —————→

(b) Describe how Leaf A and Leaf B will look like after a few days. Explain your answer. [2m]

	3
--	---

33. Mother wanted to purchase a kettle to be used on a stove as shown in the diagram below.

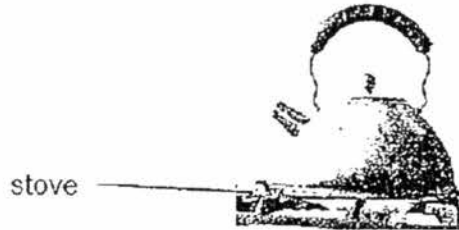

The salesperson told her that although both kettles were made from the same material, she should buy Kettle A instead of Kettle B.

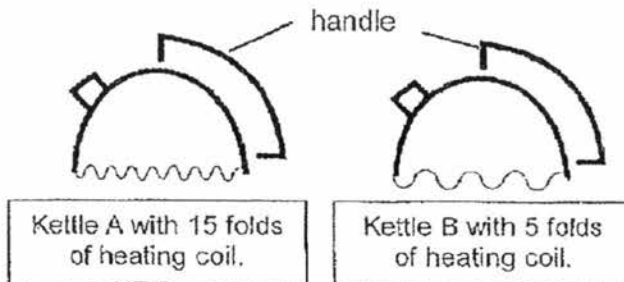

(a) Based on the above diagram, explain why Kettle A is a better choice for Mother. [2m]

	2
--	---

- (b) The salesperson showed Mother how Kettle A and Kettle B work. He poured water at room temperature of 30°C and placed data loggers in each kettle. Both kettles were heated and the water was left to boil.

Draw and label Line A to represent Kettle A and Line B to represent Kettle B to show the changes in the temperature of the water in the two kettles. [1m]

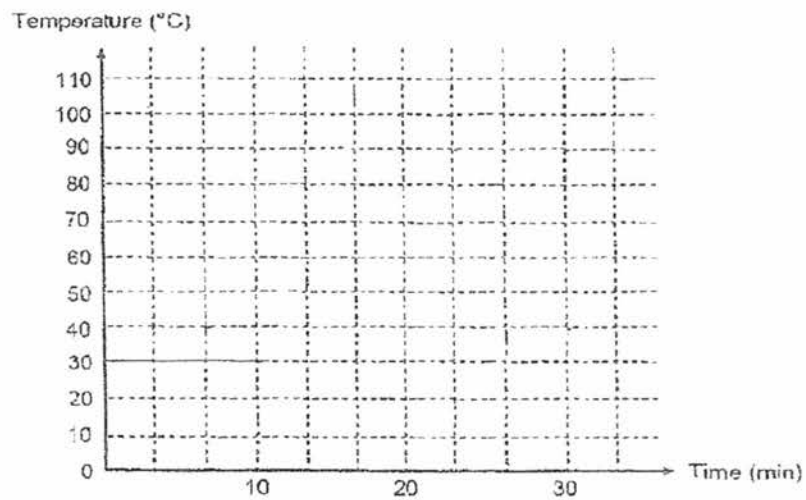

	1
--	---

34. The graph below shows the change in the temperature of water over time

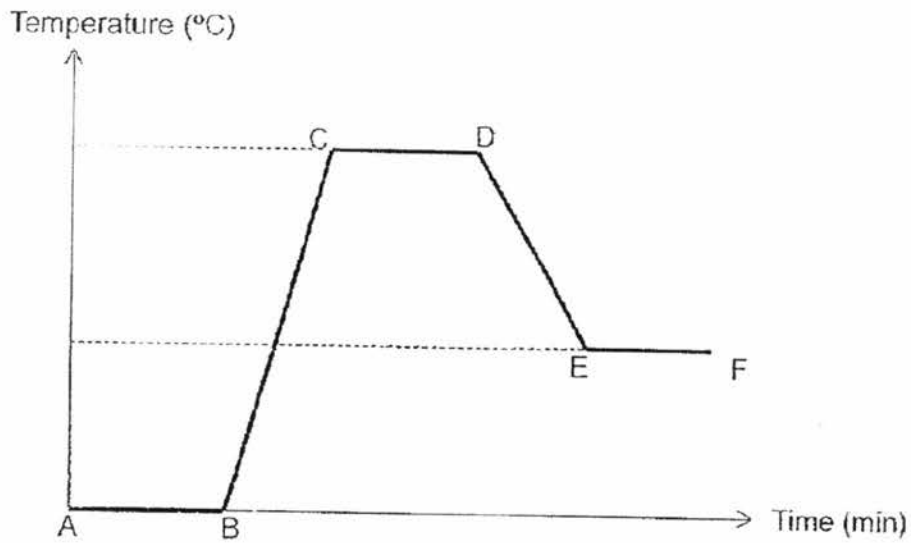

- (a) Based on the graph, Student A commented that heat was removed at Point C. Is Student A's comment correct? Explain your answer. [1m]

- (b) State two changes that Student A could have made to the water from Points D to F. [2m]

	3
--	---

35. A few students predicted that water will evaporate faster if the surrounding air temperature is higher. To confirm their prediction, they placed water in containers at two rooms of different temperatures.

(a) Name three factors that should be the same for a fair investigation. [3m]

(i) _____

(ii) _____

(iii) _____

They recorded the mass of the water and the container in Room 1 and Room 2 for 3 days. The table below shows their results.

Time (days)	Mass of water and container(g)	
	Room 1	Room 2
0	100	100
1	92	85
2	80	72
3	72	54

(b) Based on the above results, which room, 1 or 2, will have a higher air temperature? Explain your answer. [1m]

	4
--	---

36. Mandy bought some fries from a nearby fast food restaurant. She packed the fries in a plastic bag and tied it up. When she reached home, she noticed that the fries were not crispy anymore and the inside of the bag was wet.

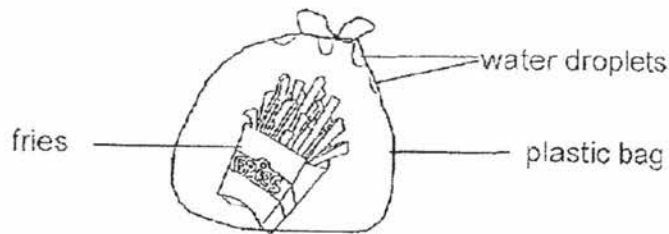

- (a) Why was the inside of the plastic bag wet? [2m]

- (b) What could Mandy do to keep the fries crispy on her way home next time? Explain your answer. [2m]

	4
--	---

**BLANK
PAGE**

37. Dave placed six metal pins P, Q, R, S, T and U on a wooden board as shown in Figure 1 below. He connected a few of the pins below the wooden board.

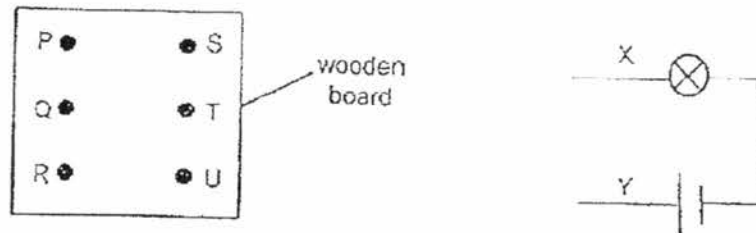
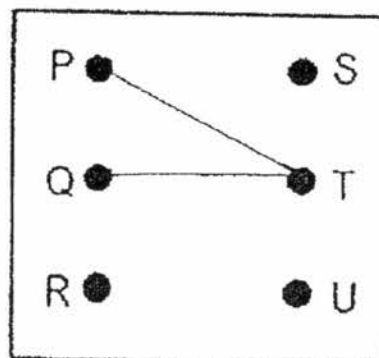

Figure 1

He then connected X and Y to the pins and recorded his results in the table below.

Pin connected to X	Pin connected to Y	Did the bulb light up?
P	S	No
Q	T	Yes
R	U	No
S	R	No
T	P	Yes
Q	P	Yes

- (a) Based on the results above, use only two lines to draw the connection of the pins in the diagram below. [2m]



	2
--	---

As shown in the picture below, streetlamps are connected in both series and parallel. Usually, a set of three streetlamps are connected in series and each set is connected in parallel to the next set.

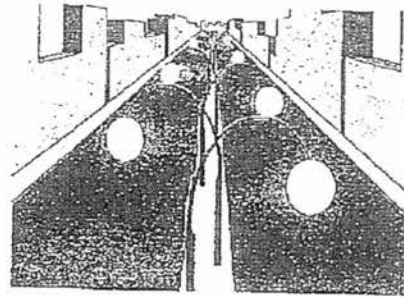

- (b) In the space below; use circuit symbols to complete the diagram to show how nine streetlamps are connected to one another. The first three streetlamps have been drawn for you. [1m]

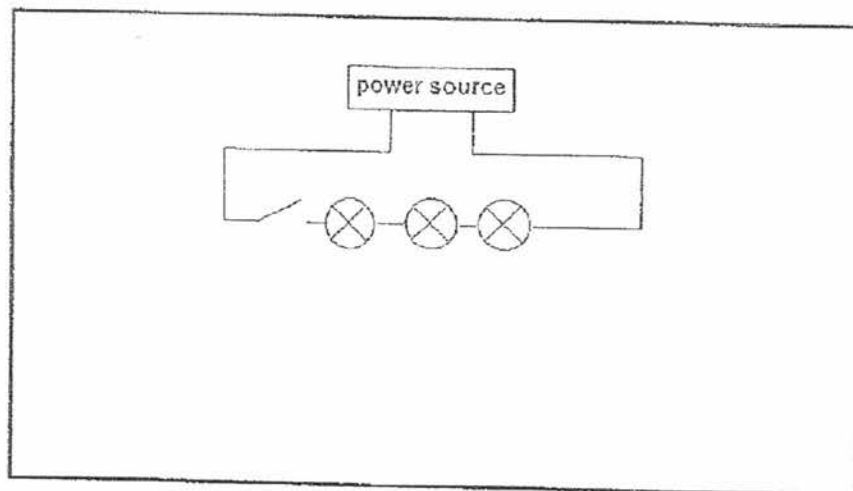

- (c) Based on the method of connection for streetlamps, how will it be safe for drivers at night? [2m]

	3
--	---

38. A heating element gives out heat. The diagrams below show how a heating element can be connected in a circuit in two different ways.

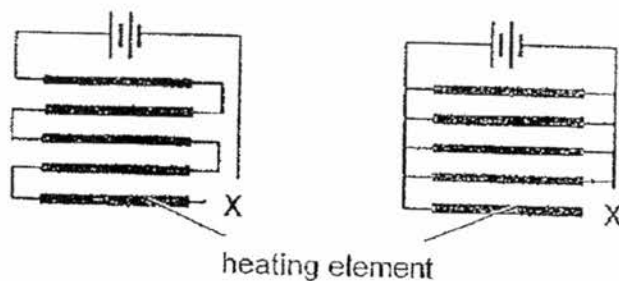

Circuit A

Circuit B

- (a) There is a break in both circuits and the break is marked "X". State if the heating element will work in both circuits and explain your answer. [2m]

Circuit A: _____

Circuit B: _____

	2
--	---

A heating element is usually installed at the back windscreen of a car as shown below. It is connected to the car battery and is used during heavy rain.

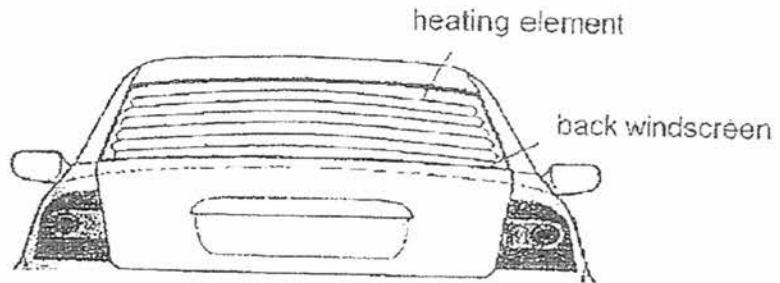

- (b) State two advantages of using Circuit B to connect the heating element to the car battery. [2m]

	2
--	---

39. Gunalan carried out an experiment to find out how the mass of an object affects the length of a spring when objects were placed on it. He placed objects of different masses on Spring P and Spring Q, and measured the length of the spring each time. The results are recorded in a graph as shown below.

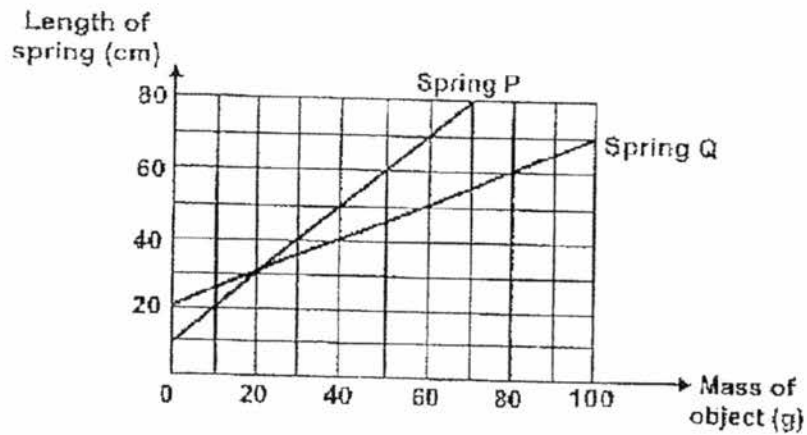

- (a) What was the mass of the object when both springs were of the same length? [1m]
-
- (b) Which spring, P or Q, had a greater elastic spring force? Explain your answer. [2m]
-
-

	3
--	----------

- (c) Gunalan repeated the experiment with Spring R and recorded the results as shown in the graph below.

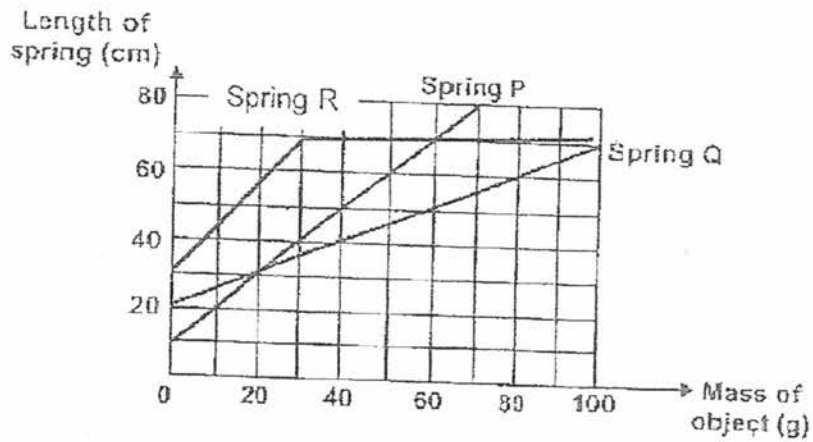

Gunalan would like to use one of the springs to measure the mass of two 1-dollar coins as shown below.



Which spring, P, Q or R is the least suitable? Explain your answer. [2m]

	2
--	---

40. Edith wanted to find out how the angle of a slope would affect how far a ball travelled. She released a ball at the top of a plank as shown in Set-up A and measured the distance the ball travelled from the bottom of the plank. She repeated the experiment with a bigger angle as shown in Set-up B.

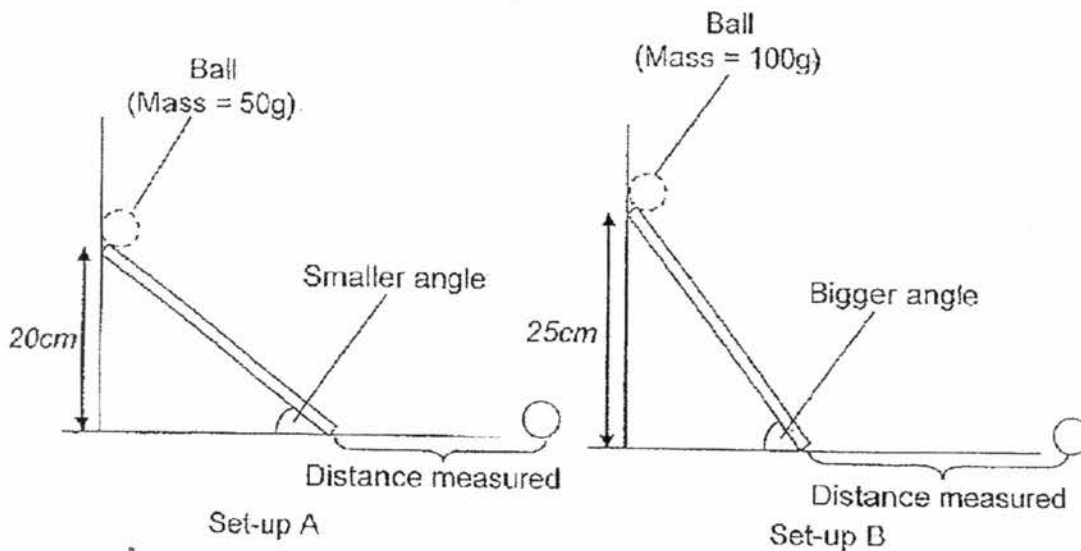

Edith predicted that the bigger angle would cause the ball to travel further. However, her teacher told Edith that her experiment was *not* a fair test and her results were wrong.

(a) Give two possible reasons why the results were wrong. [2m]

(b) What forces are at work as the ball rolled down the slope? [2m]

	4
--	---

SCHOOL : RIVER VALLEY PRIMARY SCHOOL
 LEVEL : PRIMARY 5
 SUBJECT : SCIENCE
 TERM : SA2

CONTACT : CALL MR GAN @ 9299 8971, 8606 5443, 9247 5053

SECTION A

Q 1	Q2	Q3	Q4	Q5	Q6	Q7	Q8	Q9	Q10
3	2	4	3	2	4	3	1	1	4
Q 11	Q12	Q13	Q14	Q15	Q16	Q17	Q18	Q19	Q20
2	4	4	1	2	2	3	3	2	3
Q 21	Q22	Q23	Q24	Q25	Q26	Q27	Q28		
3	1	3	1	3	2	1	4		

SECTION B

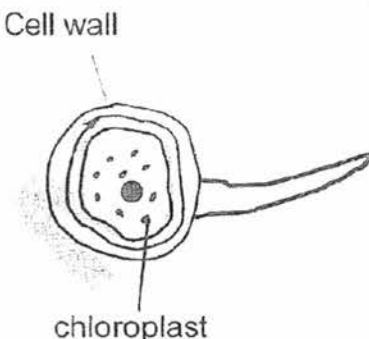
Q 29	<p>a)</p>  <p>Cell wall</p> <p>chloroplast</p> <p>b) It will enable the cell to move towards sunlight to make food and move away from danger.</p>
Q 30	<p>a) By wind. The anthers are hanging outside of the petals which makes it easy for wind to carry off the pollen grains.</p> <p>b) It will attract pollinators such as animals which will transfer pollen grains to the stigma of the flower for pollination.</p>
Q 31	<p>a) The adult fish's gills has a greater surface areas than that of the young fish.</p> <p>b) So that it can absorb more dissolved oxygen in the water.</p>

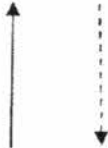
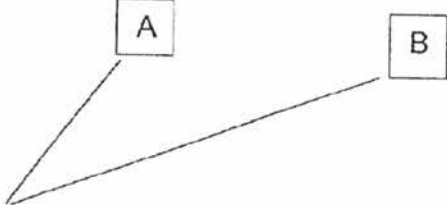
Q 32	<p>a)</p>  <p>b) After a few days, Leaf A will turn brown(wither and die) as it is unable to carry out photosynthesis due to a lack of light while Leaf B will also wither as it is able to make food due to a lack of water.</p>
Q 33	<p>a) There are more folds of the heating coil in Kettle A than in Kettle B, hence the water in Kettle A will boil faster.</p> <p>b)</p> 
Q 34	<p>a) Student A is wrong. The temperature of water stayed constant from Point C to D before dropping. Hence, heat could not have been removed at Point C.</p> <p>b) Turning off the heat at Point D. Allowing the water to cool.</p>
Q 35	<p>a) (i) Amount of water used. (ii) The exposed surface area of the water. (iii) Temperature of water at the start of the experiment.</p> <p>b) Room 2. The mass of water and container is lesser in Room 2 (54g) than in Room 1(72g) after 3 days as evaporation takes place faster in Room 2 which has a higher air temperature.</p>
Q 36	<p>a) Hot water vapour in the bag has condensed on the cooler surface of the plastic bag to form water droplets.</p> <p>b) She could open the plastic bag to allow the water vapour to escape, hence preventing the water vapour from condensing in the bag, keeping the fries crispy.</p>

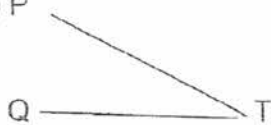
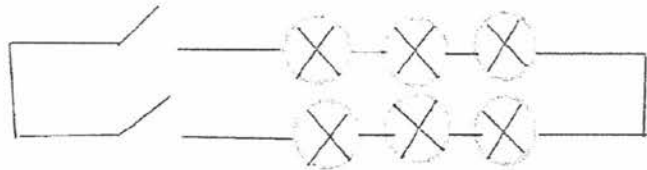
Q 37	<p>a) </p> <p>b) </p> <p>c) If one of the street lamps, arranged in a series fuses, all the other lamps in the series will not light up. However, the street lamps arranged in parallel will still remain lighted to guide the drivers at night.</p>
Q 38	<p>Circuit A: No. The break at X will result in an open circuit and the element cannot be heated up. Circuit B: Yes. The break at X will only result in an open circuit for one of the heating element. The other heating elements can still work and the circuits are closed.</p> <p>b) Electricity will be equally distributed and hence the elements will be evenly heated up. If one of the elements is not working well, the other elements can still be heated.</p>
Q 39	<p>a) 20g</p> <p>b) Spring P extends 20cm more than Spring Q when the same mass is added to both springs.</p> <p>c) Spring R. It stopped extending after placing objects of 30g whereas Spring P and Q were able to extend after objects with greater mass were placed on them.</p>
Q 40	<p>a) The mass of the 2 balls is different. The starting point of the ball is different.</p> <p>b) Frictional and Gravitational forces.</p>