



RAFFLES GIRLS' PRIMARY SCHOOL

SEMESTRAL ASSESSMENT (2) 2016

Name : _____ Index No: _____ Class: P5 _____

27 Oct 2016

SCIENCE

Attn: 1 h 30 min

Section A	50
Section B	40
Your score out of 100	90
Parent's signature	

SECTION A (25 X 2 marks)

For each question from 1 to 25, four options are given. One of them is the correct answer. Make your choice (1, 2, 3 or 4). Shade the correct oval on the Optical Answer Sheet.

The diagram below shows the classification of the plant and human reproduction systems.

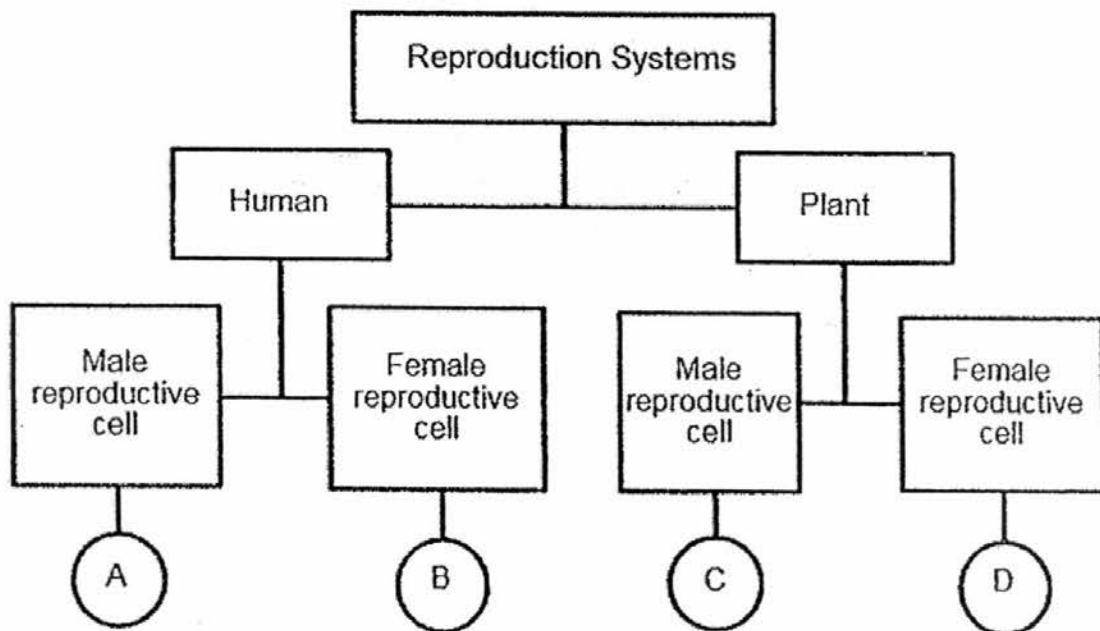

Which one of the following best represents A, B, C and D?

	A	B	C	D
(1)	sperm	egg	pollen grain	egg
(2)	penis	stigma	anther	ovule
(3)	anther	egg	penis	womb
(4)	penis	ovule	stigma	ovary

2. The diagram below shows the female reproductive system.

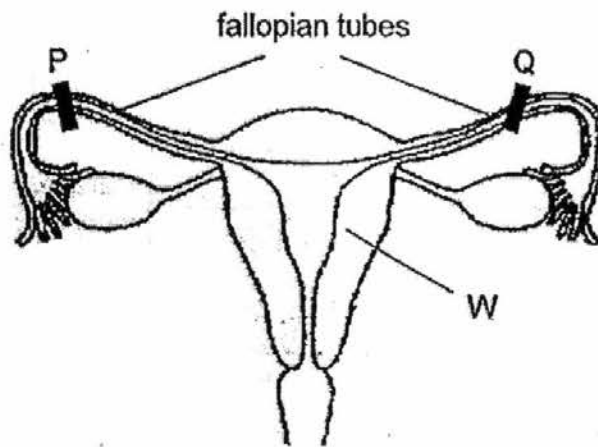

Fallopian tubes are tubes along which egg cells travel.

Which of the following statement(s) is/are true after the fallopian tubes are clipped at positions P and Q during a surgery?

- A Fertilisation cannot take place in this reproductive system.
 - B The female will not be able to produce any reproductive cells.
 - C The male reproductive cells can only reach the female reproductive cell at part W.
- (1) A only
(2) B only
(3) C only
(4) A and B only

3. The diagram below shows a fruit.

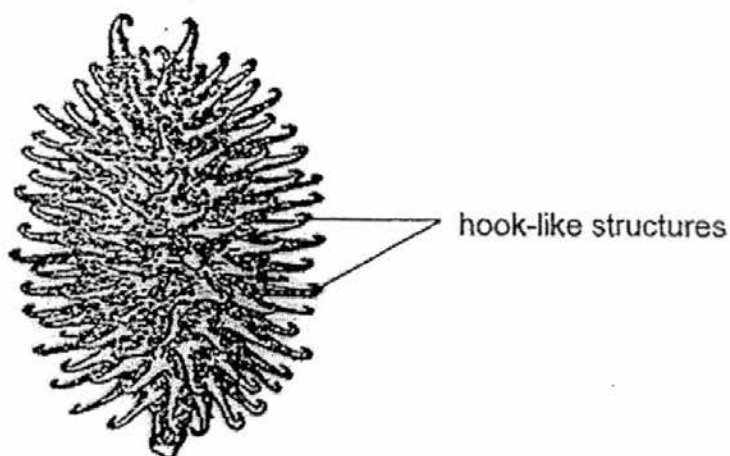

Based on the diagram above, which one of the following is the method of dispersal of the fruit?

- (1) By wind
 - (2) By water
 - (3) By animal
 - (4) By splitting
4. The diagram below shows the stages in the life cycle of a flowering plant.

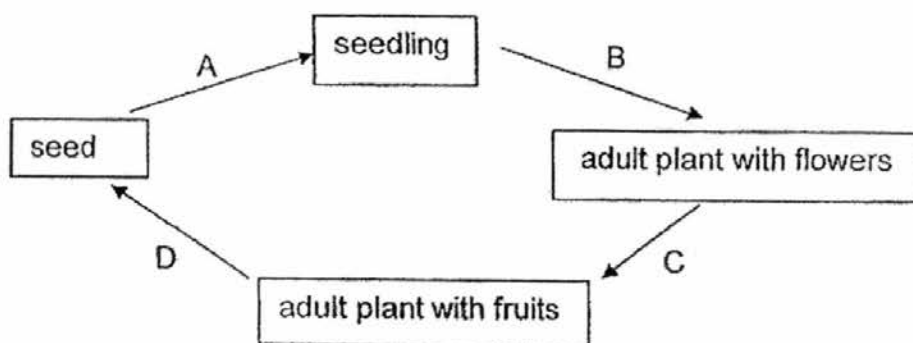

Which of the following correctly represent the processes of pollination and germination respectively?

	Pollination	Germination
(1)	B	C
(2)	B	D
(3)	C	A
(4)	C	D

5. Adam prepared three set-ups, A, B and C, using plants of the same type but with different number of leaves as shown below. The plants were placed in beakers containing 400 ml of blue-coloured water with a layer of oil on the water surface.

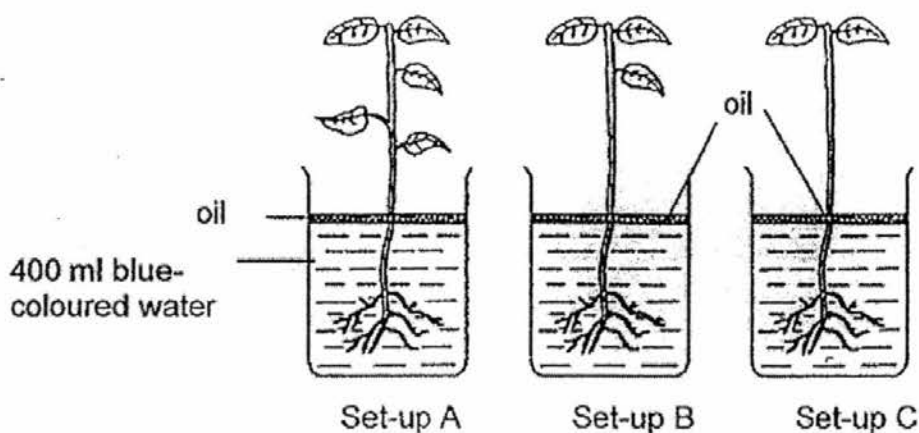

Which one of the following statements is correct?

- (1) The plants in all the set-ups would wilt.
 - (2) The leaves of the plants in all the set-ups would turn blue.
 - (3) The oil prevents the water from being taken in by the plant.
 - (4) The water level in set-up B would be the lowest at the end of the experiment.
6. The diagram below shows movement of a foot.

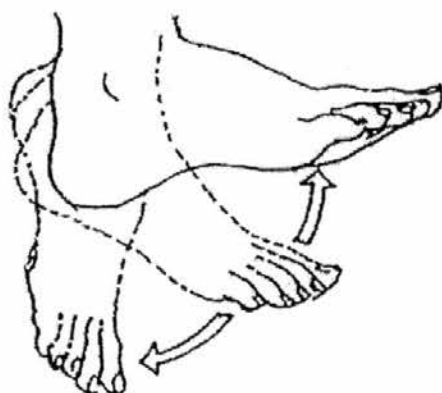

Which of the following pairs of systems need to work together to allow the foot to move?

- (1) Muscular and skeletal systems
- (2) Circulatory and skeletal systems
- (3) Respiratory and skeletal systems
- (4) Circulatory and muscular systems

7. The diagram below shows parts of a digestive system.

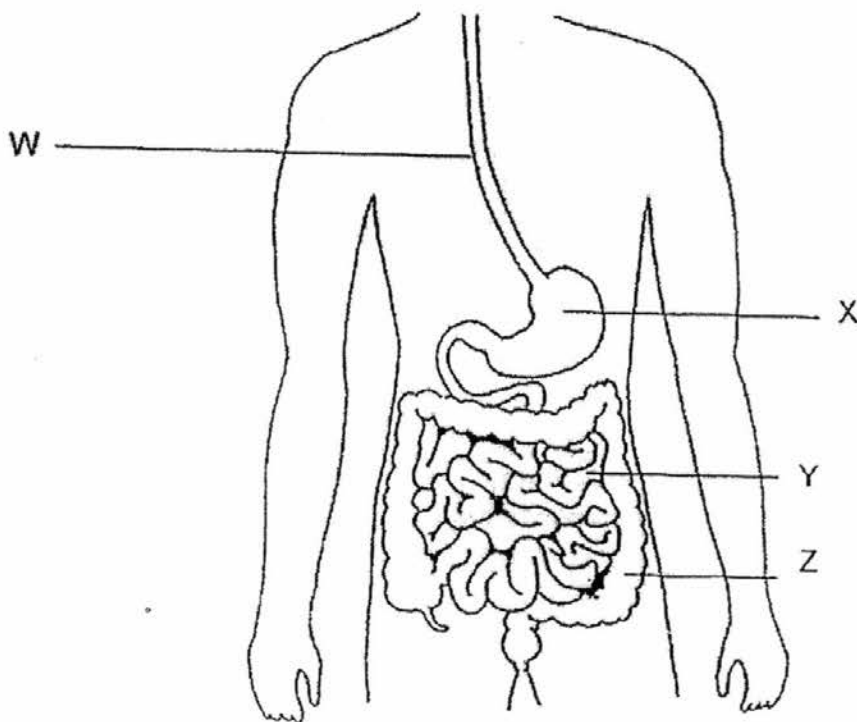

Which of the following statement(s) is/are correct about parts W, X, Y and Z?

- A Digestive juices are produced in W, X and Y
- B Water is removed from the undigested food at Z.
- C Digested food is absorbed into the bloodstream at Y.

- (1) A only
- (2) A and B only
- (3) B and C only
- (4) A, B, and C

8. Study the flowchart below.

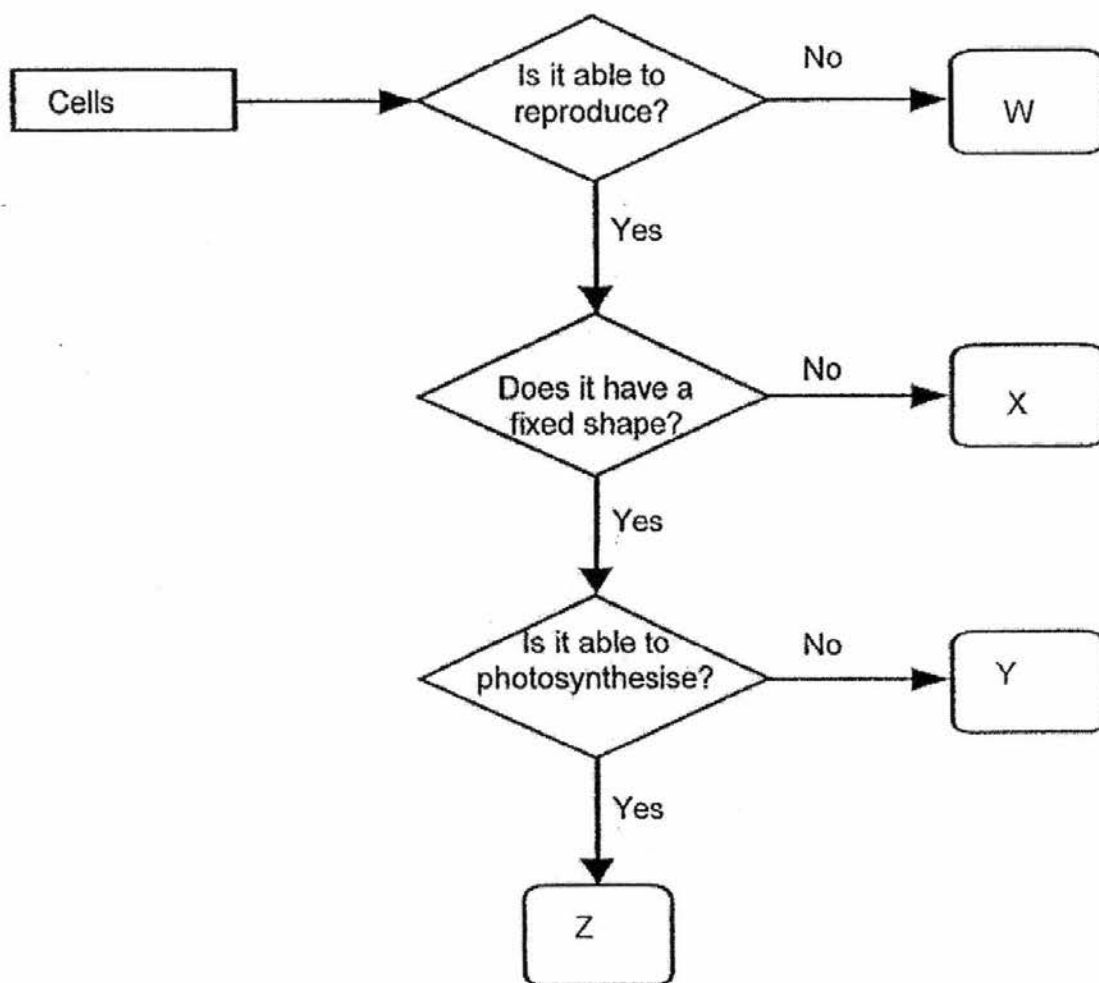

Which one of the following identifies Cells A and B correctly?

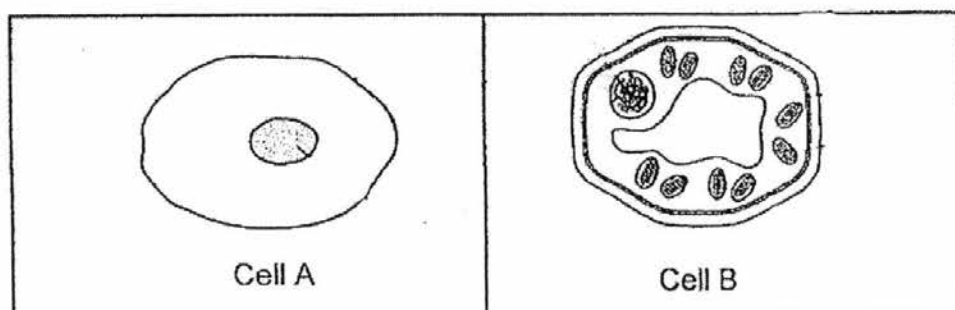

	Cell A	Cell B
(1)	W	Z
(2)	X	Y
(3)	X	Z
(4)	Y	Z

9. Which of the following correctly shows the direction of blood flow in certain parts of the human body?

(1)

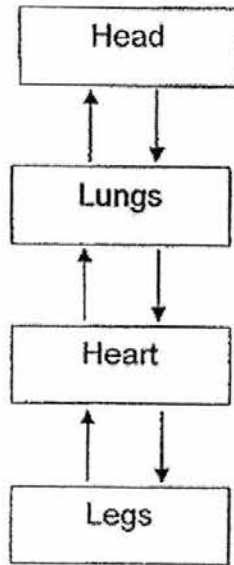

(2)

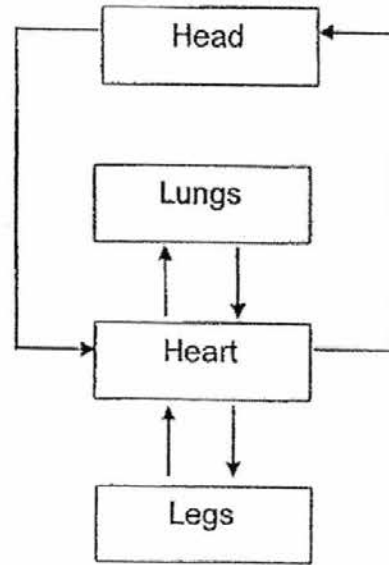

(3)

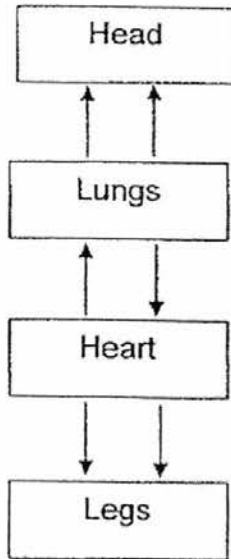

(4)

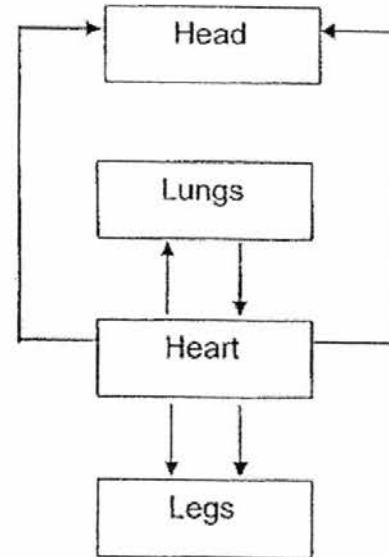

10. The diagram below shows how some substances, P, Q, R and S, are transported in the human body.

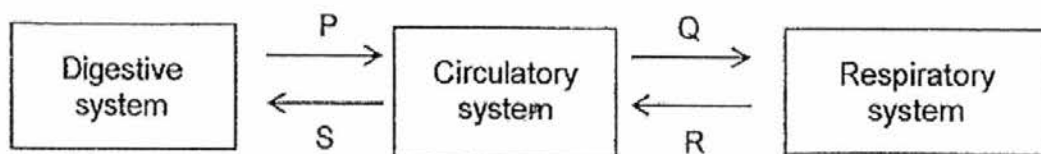

Which one of the following correctly identify the substances P, Q, R and S?

	P	Q	R	S
(1)	Oxygen	Oxygen	Carbon dioxide	Digested food
(2)	Carbon dioxide	Carbon dioxide	Oxygen	Digested food
(3)	Digested food	Oxygen	Carbon dioxide	Water
(4)	Digested food	Carbon dioxide	Oxygen	Oxygen

11. The following diagram shows a plant.

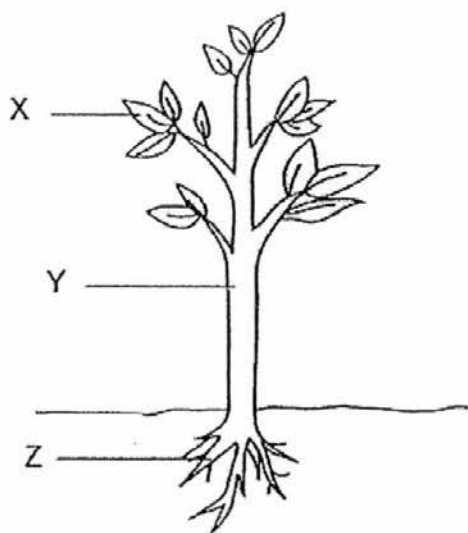

At which part(s), X, Y and/or Z, can the tubes that transport water be found?

- (1) X only
- (2) Z only
- (3) X and Y only
- (4) X, Y and Z

12. Sam wanted to investigate the conditions affecting the germination of seeds. Sam prepared four set-ups using the same type of seeds as shown below.

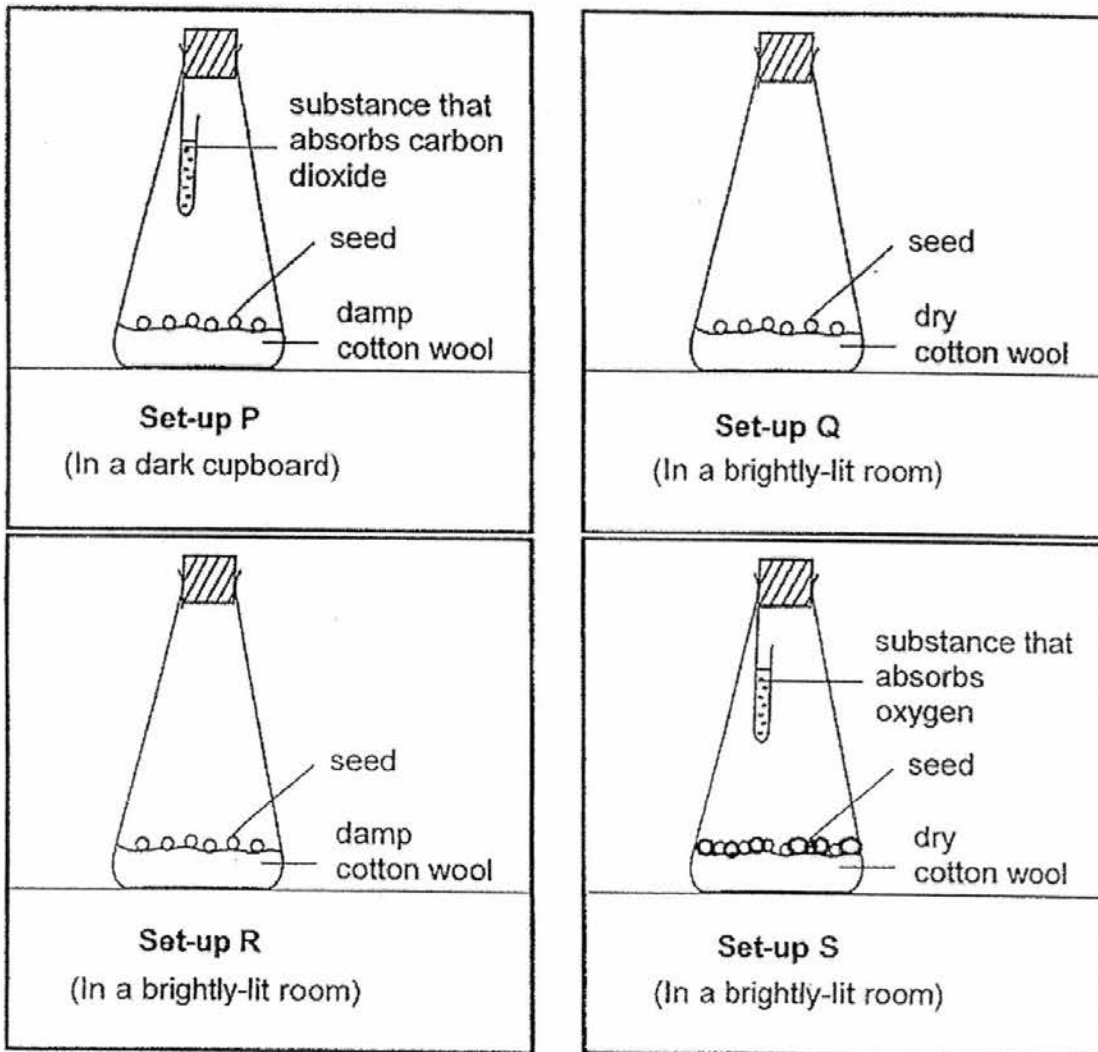

Which one of the following pair of set-ups should Sam use to investigate the respective aim?

	Aim	Set-ups
(1)	To find out if light is needed for germination of seeds.	P and R
(2)	To find out if water is needed for germination of seeds.	Q and R
(3)	To find out if oxygen is needed for germination of seeds.	Q and S
(4)	To find out if overcrowding affects germination of seeds.	P and S

13. Theresa placed a test tube containing some water into a beaker of ice and salt mixture. The diagrams below show the set-up at the beginning and at the end of the experiment.

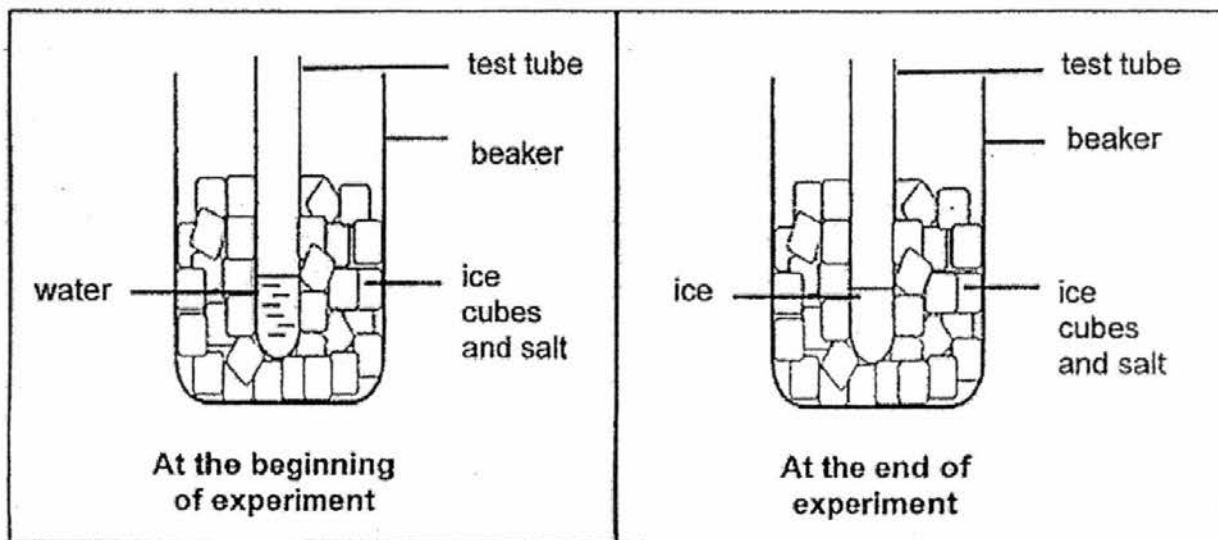

She observed that the water became ice after a while.

Which one of the following statements best explains her observation?

- (1) The water lost heat to the surrounding air.
- (2) The water lost heat to the ice and salt mixture.
- (3) The ice and salt mixture lost heat to the water.
- (4) The ice and salt mixture lost heat to the surrounding air.

14. Yanni prepared a set-up as shown in the diagram below.



Which of the following statements are true?

- A Water droplets would form at the bottom of the flask.
- B Water droplets would form on the inner surface of the flask.
- C Water droplets would form on the outer surface of the glass beaker.
- D Water droplets would form on the inner surface of the glass beaker.

- (1) A and B only
- (2) A and D only
- (3) B and C only
- (4) C and D only

15. The letters, A, B, C and D, represent four students standing at different positions in a tunnel. Four mirrors were placed in the tunnel as shown below.

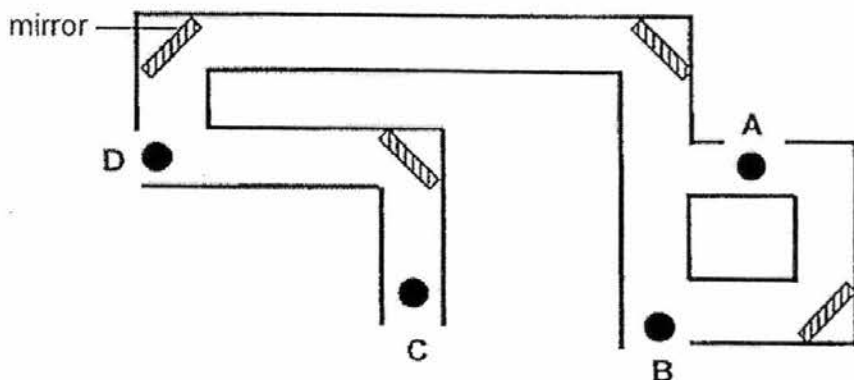

Which student, A, B, C or D, will be able to see the most number of students in the above tunnel?

- (1) A
- (2) B
- (3) C
- (4) D

16. A light sensor was used to determine the amount of light passing through four sheets, P, Q, R and S, made of different materials. The results were shown in the graph below.

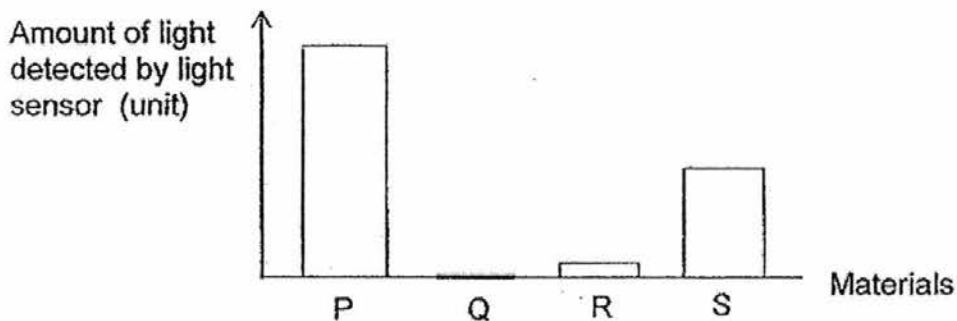

The materials were then arranged in a straight line at four positions, W, X, Y and Z. A triangular hole was cut out from one of the cards, as shown in the diagram below.

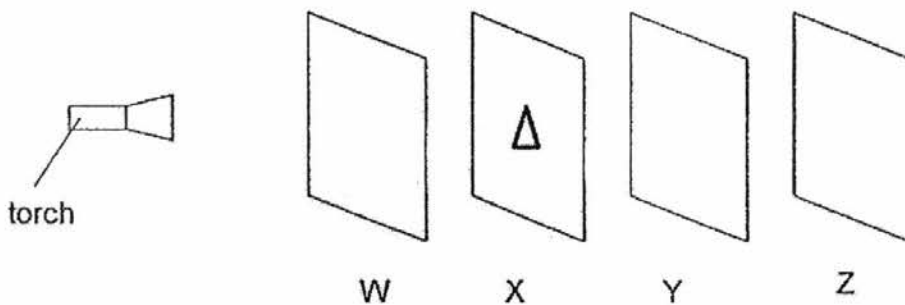

When the torch was switched on, a bright triangular patch of light was observed on the card at position Y.

Based on the information above, which of the following most likely shows the correct arrangement of the four materials?

	W	X	Y	Z
(1)	P	Q	R	S
(2)	Q	S	R	P
(3)	R	P	S	Q
(4)	S	R	P	Q

17. Susan placed a light source at position Q and an object at position S as shown below. The light source is a torch placed inside a box with a hole.

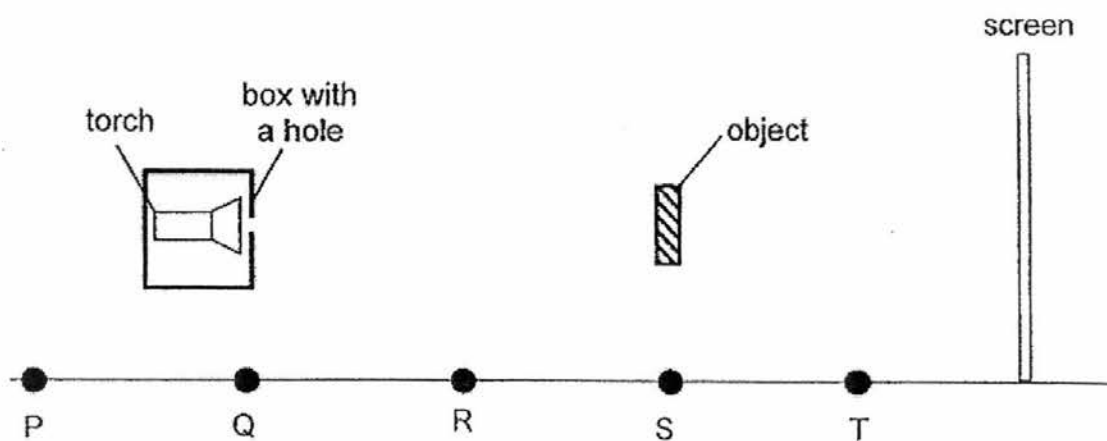

When the torch was switched on, Susan observed a shadow cast on the screen.

Which of the following shows the positions of the torch and object respectively such that a smaller shadow would be cast on the screen than the one cast above?

	Position of torch	Position of object
A	P	T
B	Q	R
C	Q	T
D	R	S

- (1) B only
 (2) A and C only
 (3) B and D only
 (4) A, B and C only

18. Substance X is a solid at room temperature. Substance X was placed in a test tube over a flame to melt. Then, it was left to cool in a room.

The graph below shows the change in the temperature of heated Substance X when it was left to cool in a room over a period of time.

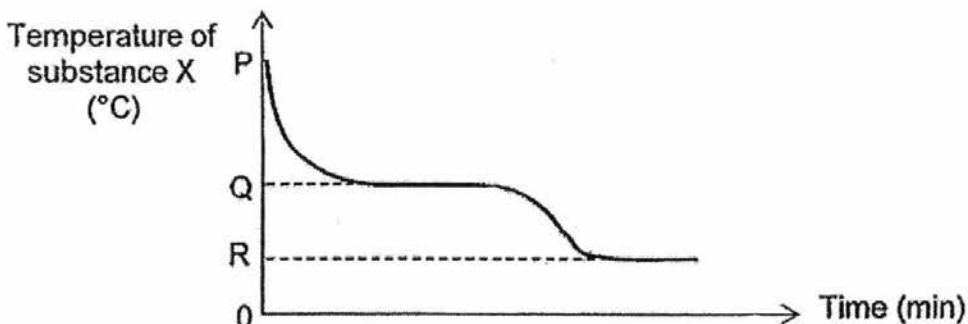

Which one of the following statements is correct?

- (1) At R, Substance X is a solid.
 - (2) Q is the temperature of the room.
 - (3) R is the melting point of Substance X.
 - (4) At P, Substance X gains heat from the surrounding.
19. Rachel poured some hot soup into a bowl and wrap a plastic sheet around the opening as shown in Figure 1. Figure 2 shows the bowl of soup observed after 5 minutes.

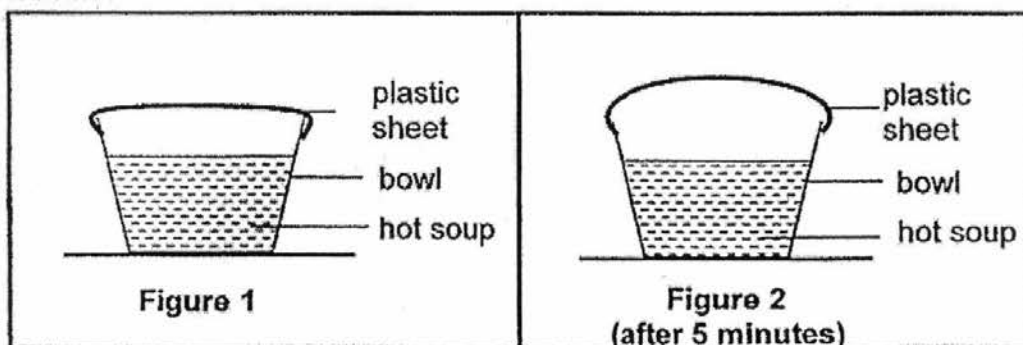

Rachel wanted to reduce the 'bulging' of the plastic sheet as shown in Figure 2. Which of the following show the correct action and corresponding explanation?

	Action	Explanation
(1)	Add ice to the hot soup.	The ice will lose heat and contract more slowly.
(2)	Poke a hole in the plastic sheet.	The hot air in the bowl will escape into the surrounding air.
(3)	Pour soup at a higher temperature into the bowl.	The soup in the bowl will gain heat and expand more quickly.
(4)	Place the set-up under the hot sun	The air in the bowl will gain heat and expand.

20. Lily had two identical large ice cubes. She smashed one of the ice cubes into smaller pieces. Then she placed the large ice cube into beaker X and all the small pieces of ice into beaker Y as shown below.

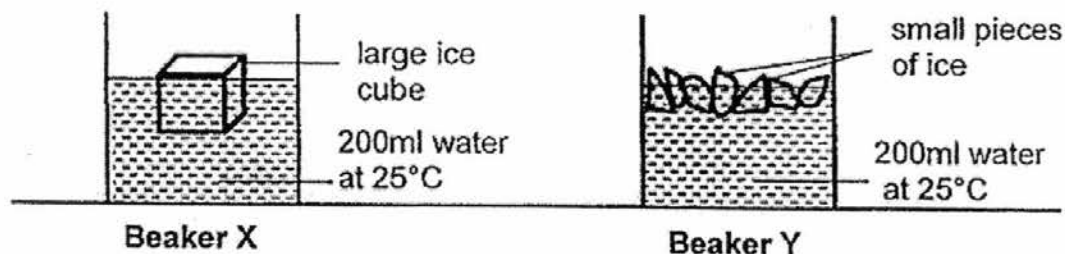

She observed that the ice in beaker X took a longer time to melt completely than the ice in beaker Y.

Which of the following statements are correct?

- A There is more ice in beaker Y than in beaker X.
 - B The temperature of the ice in beaker X is higher than the ice in beaker Y.
 - C The ice in beaker X loses heat to the water more slowly than the ice in beaker Y.
 - D The surface area of the ice exposed to water in beaker X is less than the total surface area of the ice exposed to water in beaker Y.
- (1) A and B only
(2) B and C only
(3) C and D only
(4) A, C and D only

21. Kelly wanted to find out if the arrangement of bulbs in a circuit affects the brightness of the bulbs. She set up four circuits using identical components as shown below.

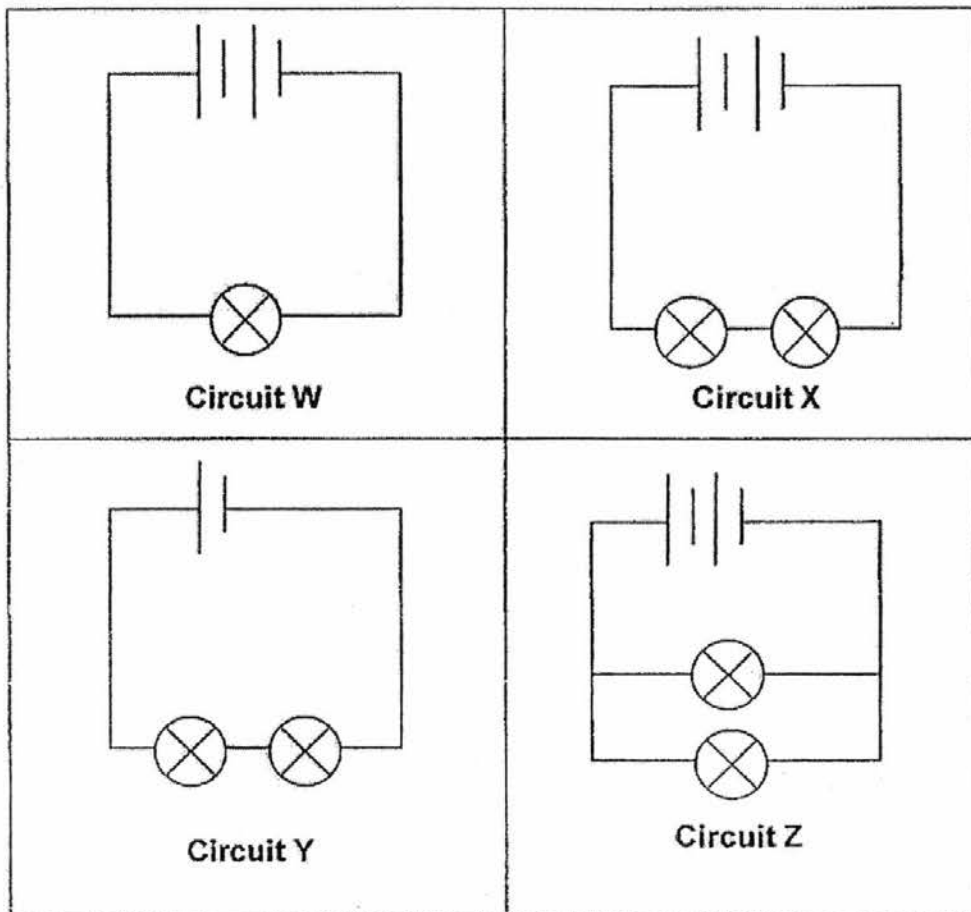

Which two circuits should Kelly use to carry out a fair test?

- (1) W and X
- (2) W and Z
- (3) X and Y
- (4) X and Z

22. Study the circuit diagram below.

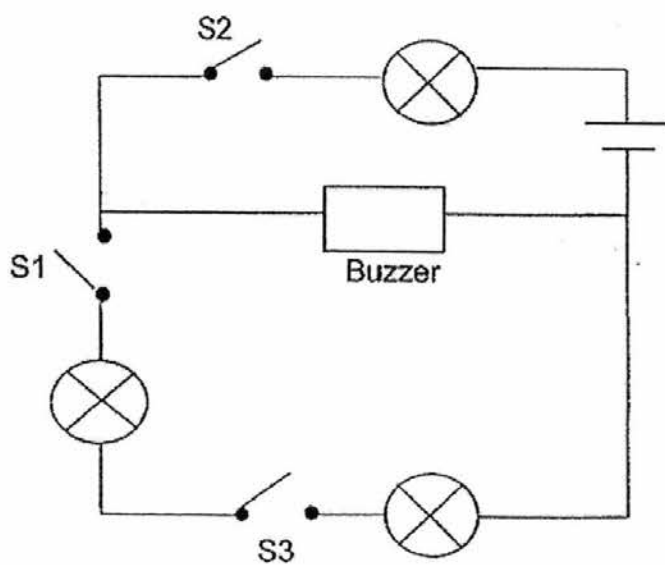

Which of the following switch(es) should be closed so that the buzzer will ring and only one of the bulbs will light up?

- (1) S2 only
- (2) S3 only
- (3) S1 and S3 only
- (4) S1 and S2 only

23. Samuel made a circuit card and the clips of his circuit card were tested with a circuit tester.

The results of his test is shown below.

Clips tester	Bulb of circuit tester
P and Q	Lights up
P and U	Does not light up
Q and S	Lights up
R and T	Does not light up

Which one of the following shows the correct arrangement of Samuel's circuit card?

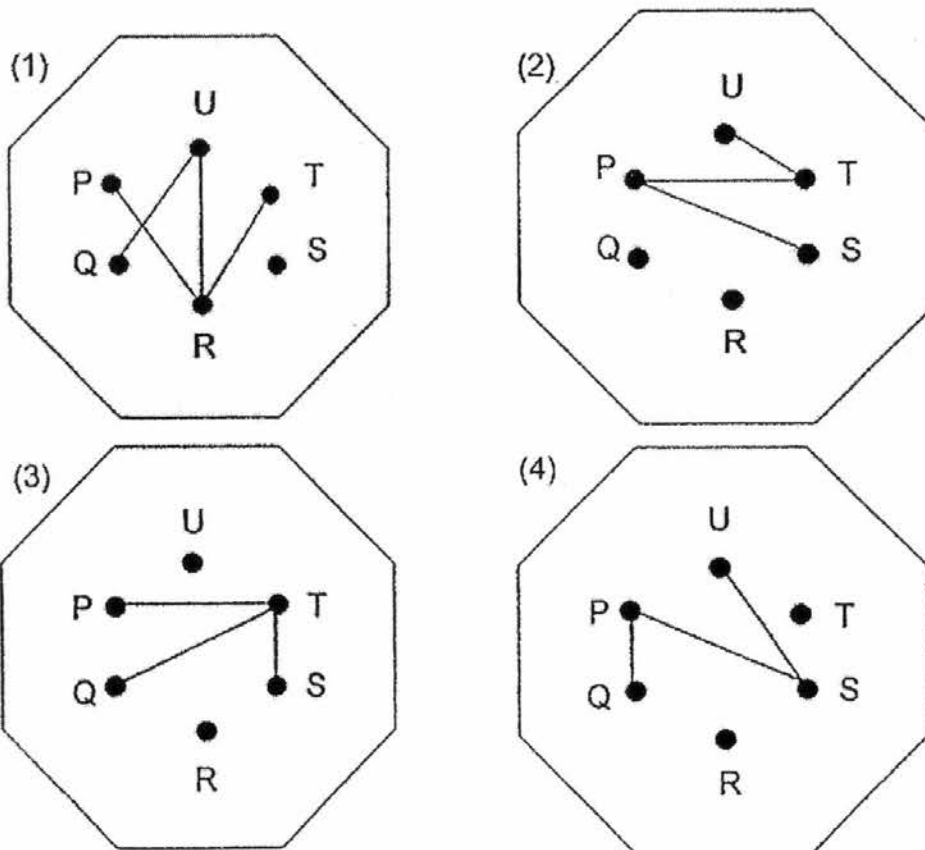

24. Joan attached magnet A to a plastic rod and a roller. The roller was hung onto a support which allowed the roller to move freely on it. Then she placed an electromagnet at a distance of 2 cm away from magnet A, as shown in the diagram below.

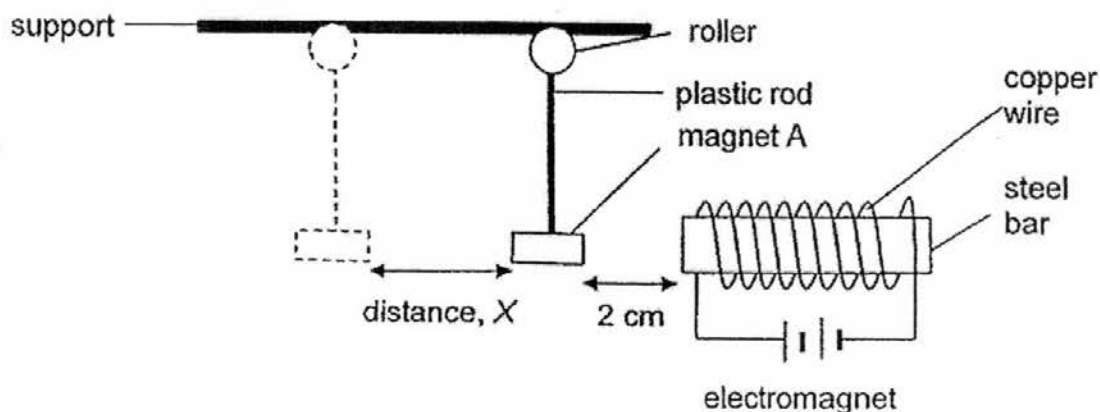

Joan observed that the iron nail moved by a distance, X.

Which of the following actions would cause the distance, X, to increase?

- A Decrease the number of coils around the steel bar.
 - B Add another battery in series arrangement to the circuit for the electromagnet.
 - C Place the electromagnet at a distance of 1 cm away from magnet A, instead of 2 cm.
- (1) A only
(2) C only
(3) A and B only
(4) B and C only

25. Tom held magnet A, 5 cm away from object X and object Y, as shown in the diagram below. Both objects X and Y are not magnets.

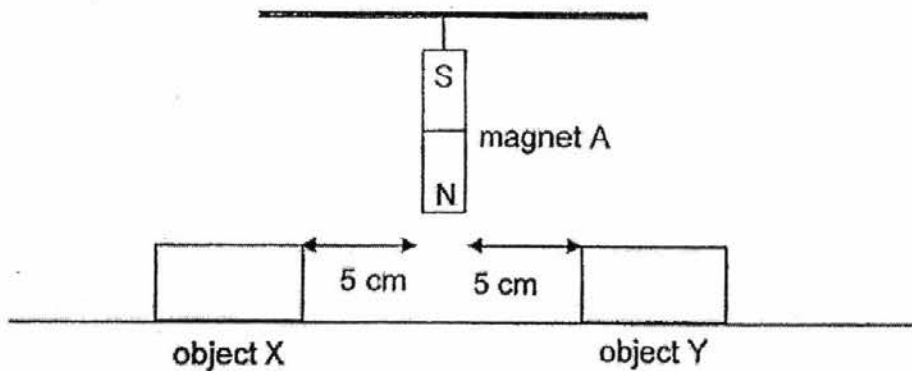

After he released the magnet A, he found that it moved towards object X, as shown below.

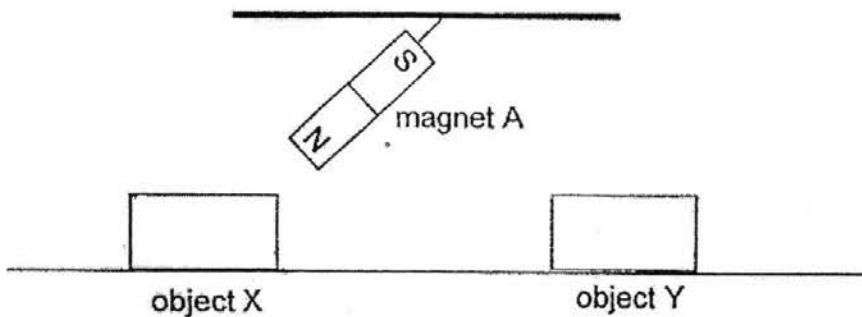

Which of the following statements(s) is/are correct?

- A Object X is a magnetic material.
- B Object Y is a non-magnetic material.
- C Unlike poles of object X and magnet A are facing each other.

- 1) B only
- 2) C only
- 3) A and B only
- 4) B and C only

Name: _____ Index No: _____ Class: P5 _____

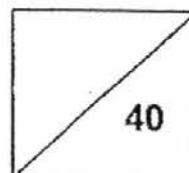

SECTION B (40 marks)

For questions 26 to 38, write your answers clearly in the spaces provided.

The number of marks is shown in brackets [] at the end of each question or part question.

26. The diagrams below show the male and female reproductive systems in humans.

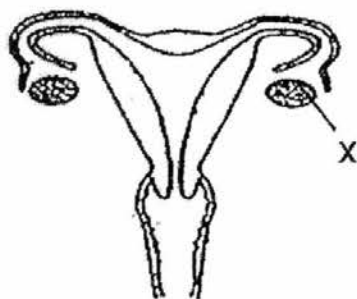

Female

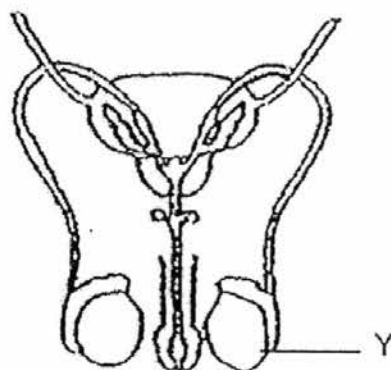

Male

- (a) Identify the parts labelled X and Y. [2]

X : _____

Y : _____

- (b) State the common function performed by Part X and Part Y. [1]

SCORE	3
-------	---

27. The classification table below shows how some living things are grouped.

P	Q
fern mushroom	papaya rose plant

(a) Give a suitable heading for P and Q.

P: _____

Q: _____

(b) State one difference between a fern and a mushroom. [1]

The diagram below shows an edible juicy and fleshy fruit containing small seeds.

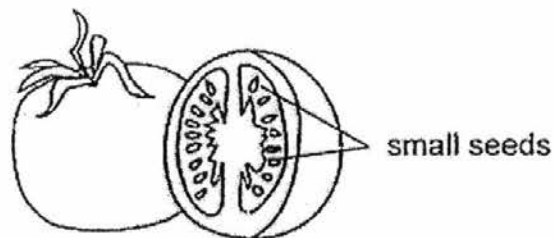

(c) Explain clearly how the seeds are dispersed. [2]

SCORE	3
-------	---

28. Adam placed two similar plants in two identical pots. The pots are filled with the same amount of soil of the same type as shown in the diagrams below.

He wrapped roots of the plant in Set-up B with a plastic bag. He placed both set-ups in the garden for 3 weeks. He watered both plants daily with the same amount of water.

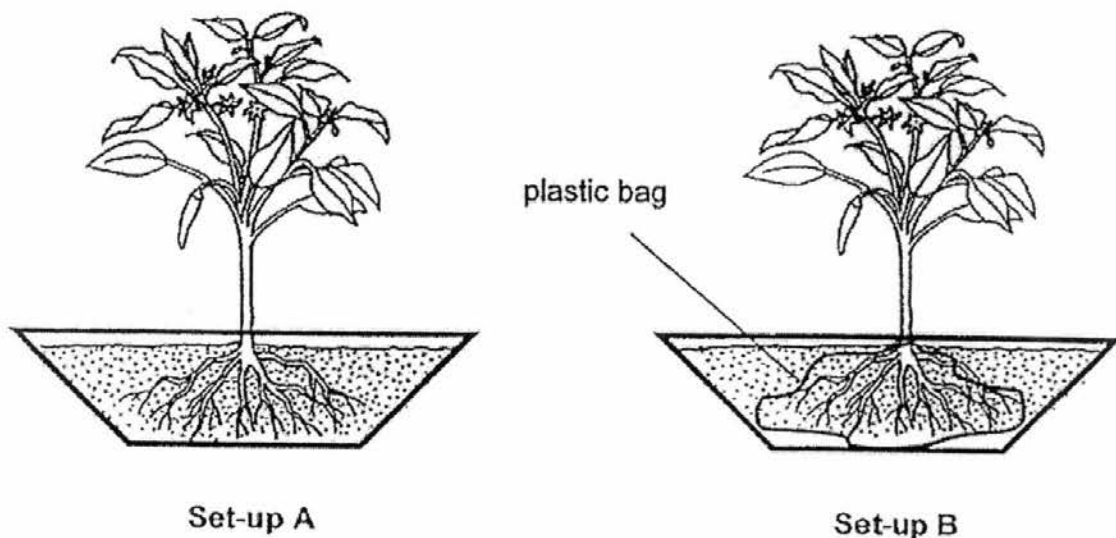

- (a) At the end of the experiment, he observed that the plant in Set-up A has grown taller, but the plant in Set-up B has died. Explain his observations clearly.

[2]

- (b) Adam placed both set-ups at the same location in the garden. How does this ensure a fair test?

[1]

SCORE	3
-------	---

29. The graph below shows the amount of undigested food as it leaves the different parts of the digestive system.

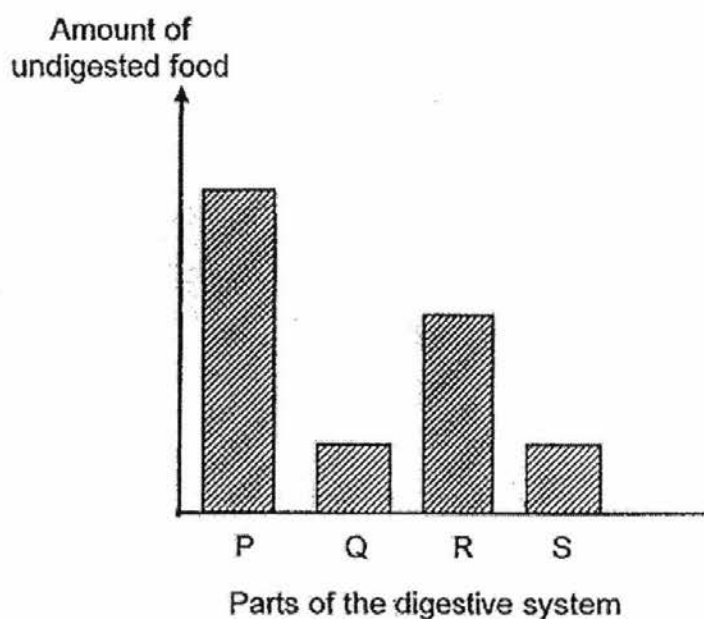

- (a) Based on the graph above, match parts P, Q, R and S in the graph to the parts of the digestive system in the table below. [2]

Parts of the digestive system			
mouth	stomach	small intestine	large intestine

- (b) Which part of the digestive system, P, Q, R or S, has the same amount of undigested food as the gullet? Give a reason for your answer. [1]

SCORE	3
-------	---

30. The table below shows the parts found in different types of cells. A tick (✓) indicates the presence of the cell part.

Cell parts	Cell A	Cell B	Cell C
cell wall	✓	✓	
nucleus	✓	✓	
cell membrane	✓	✓	✓
chloroplast	✓		

- (a) Based on the table above, which of the following cell(s) is/are able to reproduce? Give a reason for your answer. [1]

- (b) The diagram below shows a cell.

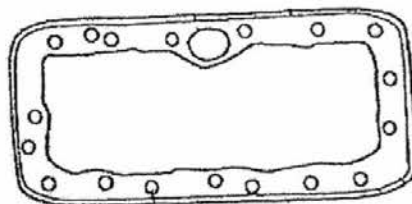

- Peter identify the above cell as Cell B. Do you agree with Peter? Give a reason for your answer. [1]

- 31 The diagram below shows how different substances are transported in a plant. The different arrows represent the transport of different substances in a plant and R represents a plant part.

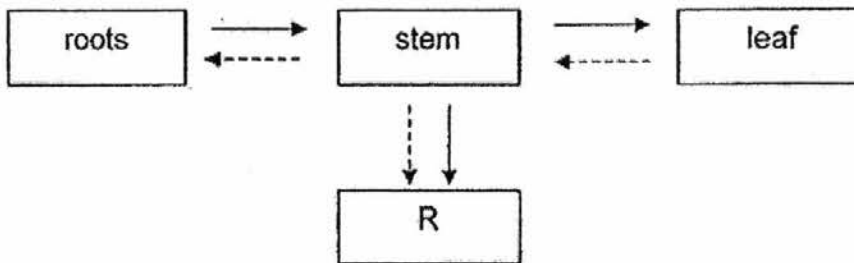

- (a) Identify one substance that is being transported by each of the arrow.[1]

(i) \longrightarrow : _____

(ii) \dashrightarrow : _____

- (b) Identify plant part R.

[1]

SCORE	2
-------	---

32. The graph below shows how Mandy's heartbeat rate changed over a period of time.

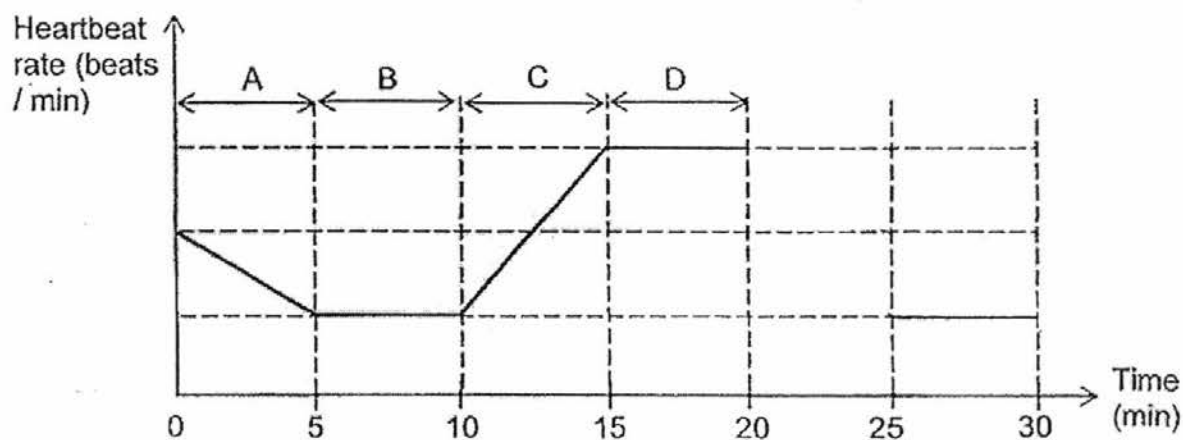

- (a) Based on the graph, during which period, A, B, C or D, was the greatest amount of carbon dioxide given out by Mandy? Explain your answer. [1]

- (b) Suggest an activity Mandy was doing during period B. [1]

- (c) Complete the above line graph to show Mandy's heartbeat rate returning to resting heartbeat rate 10 minutes after the activity had been carried out at period D. [1]

SCORE	3
-------	---

33. Desmond prepared two set-ups, X and Y, using two identical plants as shown below. He removed some roots from the plant in set-up X and most of the roots from the plant in set-up Y.

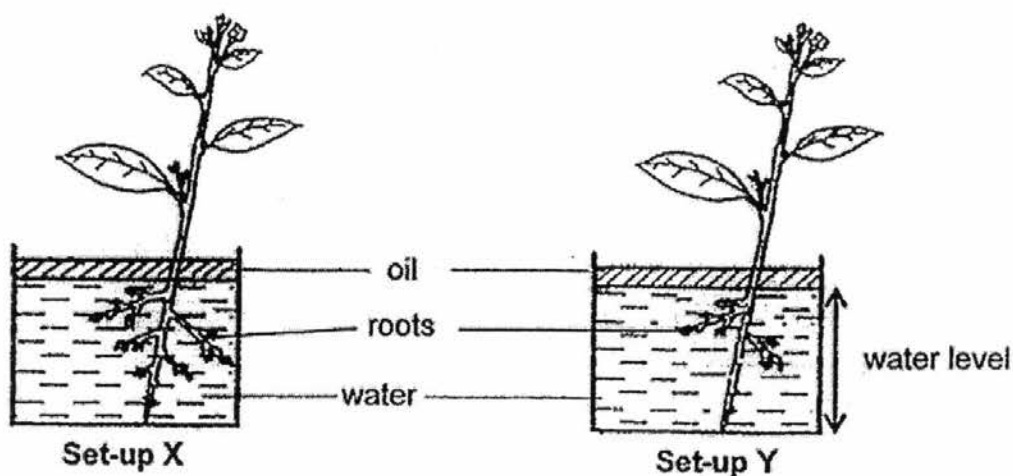

He recorded the water level of both set-ups at regular intervals shown below.

Set-up	Water level (cm)			
	Day 1	Day 5	Day 10	Day 15
(i) _____	30	25	18	11
(ii) _____	30	20	12	4

- (a) Fill in the correct blanks with X and Y in the above table which represent the correct water levels. [1]
- (b) Explain your answer in (a)(i) clearly. [2]

SCORE	3
-------	---

34. Mrs Lim took a freshly-baked cake out of the hot oven, and immediately placed it in a glass container as shown in the diagram below.

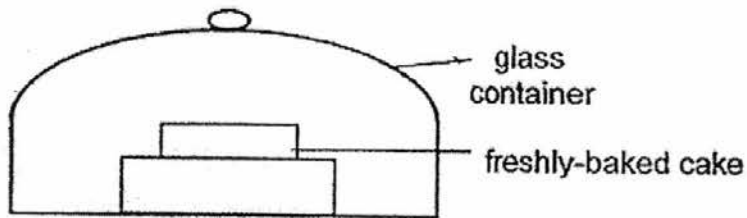

Some water droplets were observed on the inner surface of the glass container ten minutes after the cake has been placed in the glass container.

- (a) Explain how the droplets of water were formed. [2]

Mrs Lim baked another cake and left it to cool in the kitchen for half an hour before putting it in another glass container.

- (b) Comparing with the first set-up, would the amount of water droplets observed on the inner surface of the glass container increase, decrease or remain the same ten minutes after the cake has been placed in the glass container? Explain your answer. [1]

35. Grace tied her wet hair in a bun as shown in diagram 1 below. Her mother told her to let her hair down as shown in diagram 2.

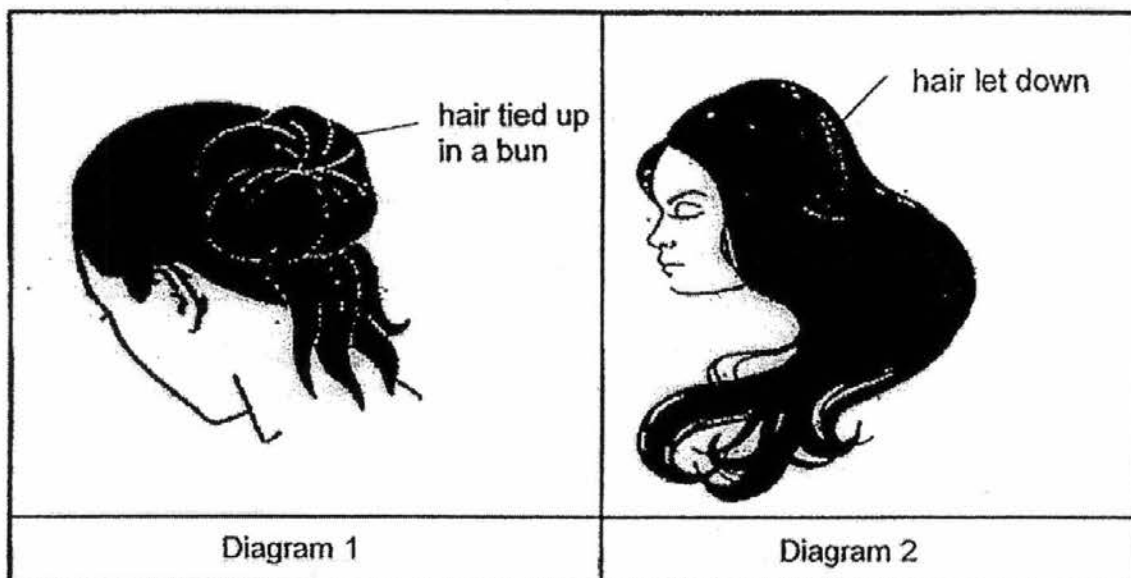

- (a) Her mother told her that her hair would dry faster if she lets it down. Do you agree with her mother? Explain your answer clearly. [2]

- (b) State another way that would help Grace dry her hair faster. [1]

SCORE	3
-------	---

36. Jane had three rods, X, Y and Z, made of different materials. When she touched the rods with her hands, X was the coldest, followed by Z and then Y.

(a) Explain why Jane's hand felt cold when she touched the rods. [1]

Then Jane heated the rods, X, Y and Z, to 85°C. She then placed each of them into a beaker of water as shown below.

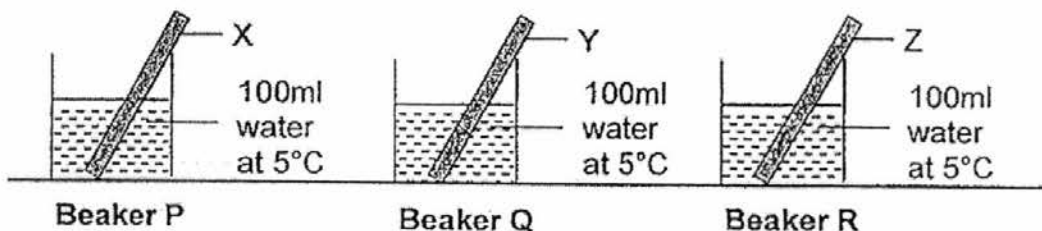

She left the beakers in her room and measured the temperature of water in each beaker over a period of time. The line graphs below show the results of her experiment.

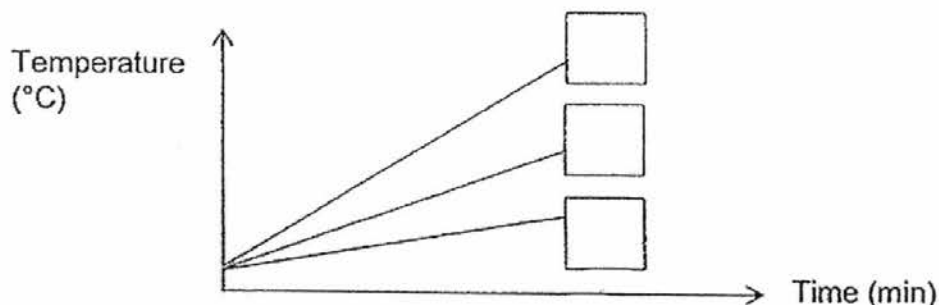

(b) Label the above line graphs by writing 'P', 'Q' and 'R' in the correct boxes. [1]

(c) Rods X, Y and Z were left in the freezer overnight. Based on the above information, which rod should be placed in a cup of hot tea for the tea to cool in the shortest period of time? Explain your answer clearly. [2]

SCORE	4
-------	---

37. Justin wanted to find out if rods, X, Y and Z, are conductors of electricity. He placed the rods in two electrical circuits as shown below.

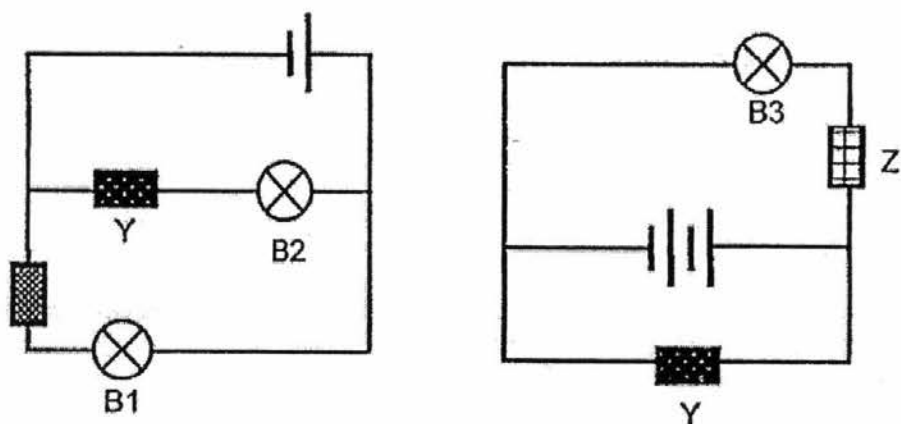

He observed that B1 and B3 lit up but B2 did not.

- (a) Based on Justin's observations above, classify rods, X, Y and Z, based on their electrical conductivity in the table below. [1]

Conductors of electricity	Insulators of electricity

- (b) Suggest a material that rod X could be made of. [1]

(continued on next page)

SCORE	2
-------	---

(continued from previous page)

Justin then placed rods X, Y and Z in another electrical circuit as shown below.

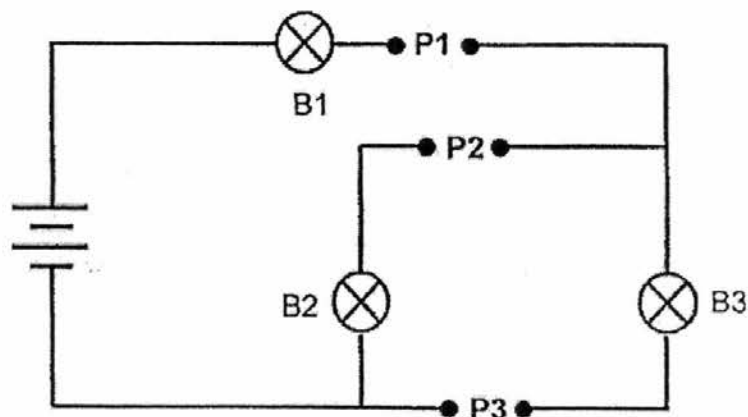

- (b) In the table below, put a tick (✓) in the correct box(es) to show the bulb(s) that would light up when the three rods were placed at the different positions P1, P2 and P3. [2]

	Positions where rods were placed			Bulb		
	P1	P2	P3	B1	B2	B3
(i)	X	Y	Z			
(ii)	Z	X	Y			

SCORE	2
-------	---

38. The diagram below shows an iron ball hung at an equal distance between the two set-ups, A and B. Both set-ups, A and B, were constructed using similar batteries and wires.

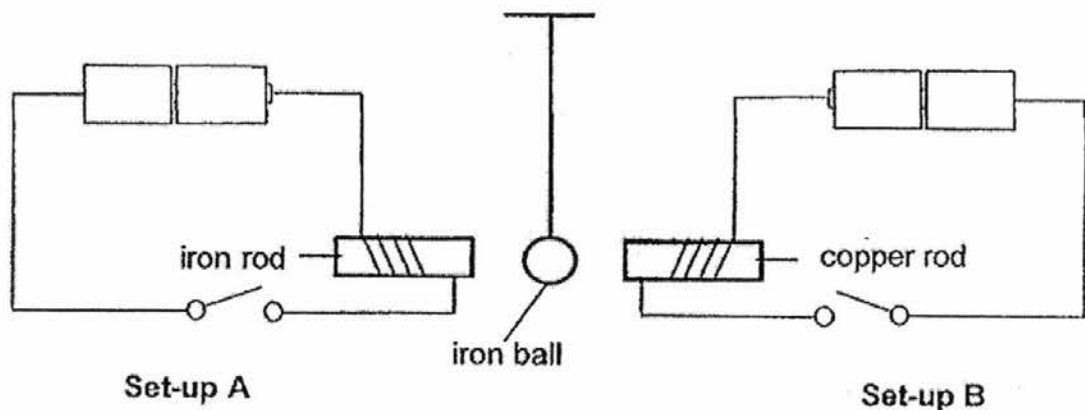

- (a) What will happen to the iron ball when the switches in set-ups, A and B, are closed at the same time? Explain your answer. [2]

- (b) What would happen if the iron rod is replaced with an aluminium rod and the switches in both set-ups are closed at the same time? Explain your answer. [2]

- End of Paper -

SCORE	4
-------	---

EXAM PAPER 2016 (P5)

SCHOOL : RAFFLES GIRLS'

SUBJECT : SCIENCE

TERM : SA2

Q1	Q2	Q3	Q4	Q5	Q6	Q7	Q8	Q9	Q10
1	1	3	3	2	1	3	3	2	4
Q11	Q12	Q13	Q14	Q15	Q16	Q17	Q18	Q19	Q20
1	2	2	2	4	1	2	1	2	3
Q21	Q22	Q23	Q24	Q25					
4	1	3	4	3					

26)a)X: ovary

Y: testis

b)Both part X and produce reproductive cells.

27)a)P: reproduce by spores.

Q: reproduce by seeds.

b)Ferns can made its own food but mushroom cannot make its own.

c)Animals will eat the fruit and the seeds and the seeds will get passed out through its droppings.

28)a)The roots in set-up B was wrapped with a plastic bag so it could not take in any water and nutrience from the soil to survive but the roots in set-up A is not wrapped with a plastic bag so it will be able to take in water and nutrience to survive therefore the plant in set-up A has grown taller but the plant in set-up B died.

b)Both plants would be able to receive the same amount of light.

29)a)P R Q S

b)Part P. There is no digestion taking place at the gullet and there should be the same amount of undigested food leaving the gullet as the mouth.

30)a)Cells A and B. Both cells have a nucleus to reproduce.

b)I do not agree with Peter. Cell B does not have chloroplast but the cell above has chloroplast.

31)a)i)water ii)food

b)Flowers.

32)a)The heart pumped most amount of oxygenated blood to all Part of the body to release most amount of energy and remove more carbon dioxide produced.

b)Sleeping.

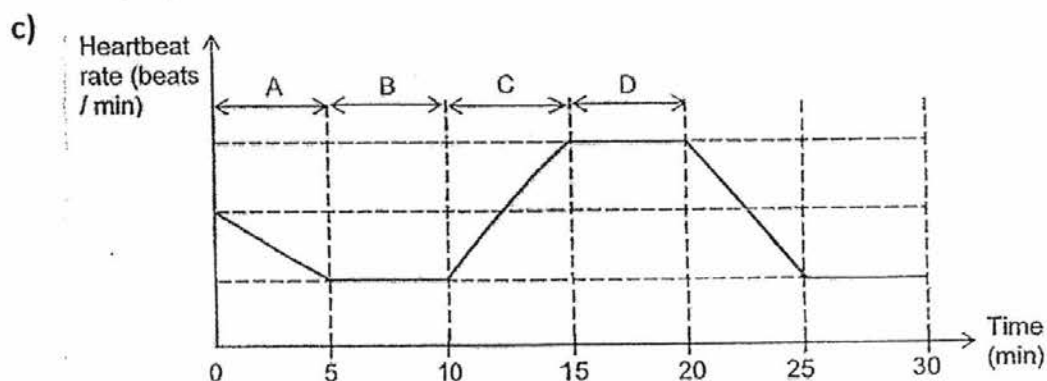

33)a)i)Y ii)X

b)The plant in set-up X has more roots taking in more water but as for the plant in set-up Y has lesser roots taking in lesser water.

34)a)The water vapour in the air within the container gained heat from the cake. The warmer water vapour lost heat to the cooler inner surface of glass container and condensed into water droplets.

b)Decrease. The temperature of difference between the warmer water vapour in the container and cooler glass container is smaller thus reduced the rate of condensation was slowed down.

35)a)The expose surface area of the water on the untied wet hair is greater so the water on the wet hair can gain heat and evaporate faster from the surrounding air.

b)She could dry her hair over a heat source.

36)a)Jane's hand loss heat to the rods thus her hand felt colder when she touched it.

b)P , R , Q

c)Rod X. There is greatest increase in the temperature of water in beaker with rod X shows that X is the best conductor of heat. It conducted the most amount of heat away from the hot tea to the surrounding air.

37)a) Conductors of electricity

Insulators of electricity

Z, X

Y

b)Steel (any metals/copper/iron)

b)i)B1 , B3 ii)B1, B2

38)a)The iron ball would move towards the iron rod only iron rod would get magnetised and attract the iron ball as it is a magnetic material but the copper rod would not get magnetised as it is not a magnetic material.

b)The iron ball will not be attracted to the aluminium and copper rods. The alminium and copper rods are not magnetic therefore cannot be magnetised.