



NANYANG PRIMARY SCHOOL

PRIMARY 5 SCIENCE

SEMESTRAL ASSESSMENT 2

2016

BOOKLET A

Date : 24 Oct 2016

Duration : 1 h 45 min

Name : _____ ()

Class: Primary 5 (

**DO NOT OPEN THIS BOOKLET UNTIL YOU ARE TOLD TO DO SO.
FOLLOW ALL INSTRUCTIONS CAREFULLY.**

Booklet A consists of 18 printed pages including this cover page.

Section A (28 x 2 marks = 56 marks)

For each question from 1 to 28, four options are given. One of them is the correct answer. Make your choice (1, 2, 3 or 4). Shade the correct oval (1, 2, 3 or 4) on the Optical Answer Sheet provided.

1. The diagrams below show the same plant which has a life cycle of four years, before and after three months.

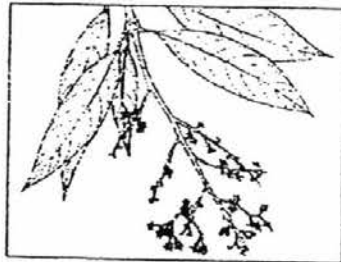

before



after

Which processes have taken place in the plant shown above?

- A dispersal
- B pollination
- C fertilisation
- D germination

- (1) A and C only
- (3) B and C only

- (2) A and D only
- (4) B, C and D only

2. The diagrams below show parents X and Y.



X



Y

Based on the characteristics shown, which of the following could likely be their offspring(s)?



A



B



C



D

- (1) D only
- (3) B and D only

- (2) A and C only
- (4) A, C and D only

3. The graph below shows the amount of oxygen found in blood samples taken from 4 blood vessels W, X, Y and Z in the human body.

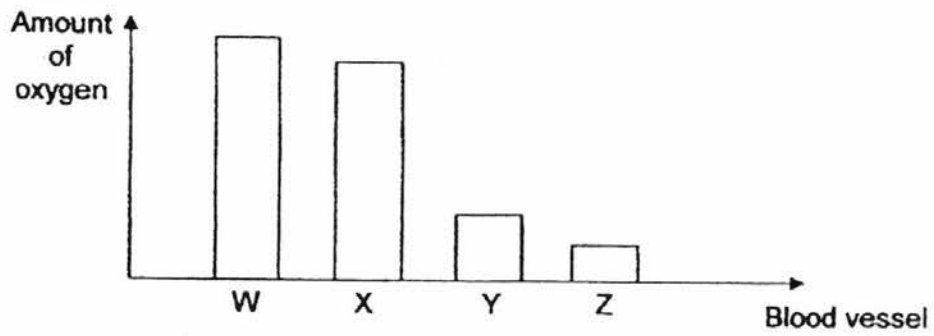

Which one of the following diagrams shows the correct movement of blood that matches the blood vessels?

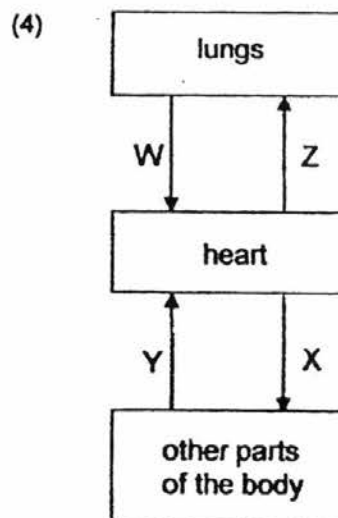
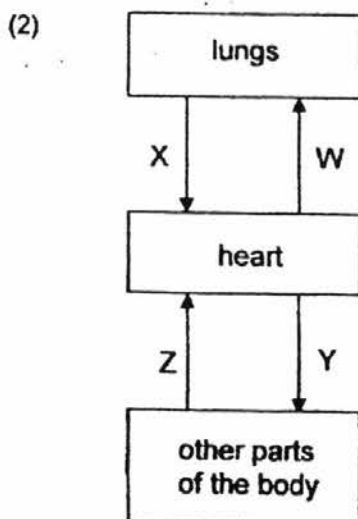
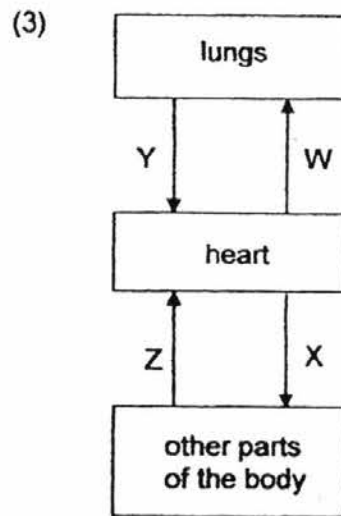
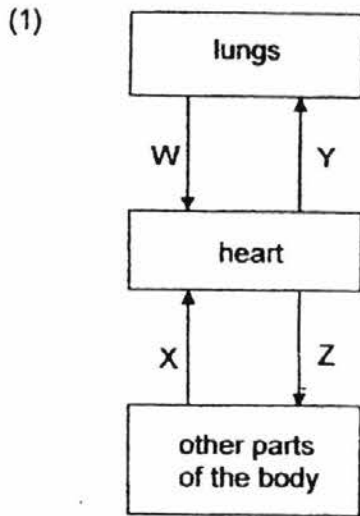

4. Fishes take in and give out air in the water using gills.

Which of the following statements are **correct**?

- A Blood flowing from the gills to the heart is rich in oxygen.
- B Gills have a small surface area and they are rich in blood.
- C Water containing dissolved air enters the fish from under the gill covers.
- D Carbon dioxide is removed from the blood in the gills and flows out in the water under the gill covers.

- (1) A and D only
- (2) B and C only
- (3) A, C and D only
- (4) B, C and D only

5. Siti observed three cells, P, Q and R, and recorded her observations of each cell in the table below.

A tick (✓) shows that the cell part is present.

| Cell Part | Cell P | Cell Q | Cell R |
|---------------|--------|--------|--------|
| Nucleus | ✓ | | ✓ |
| Cell wall | ✓ | | ✓ |
| Chloroplast | | | ✓ |
| Cell membrane | ✓ | ✓ | ✓ |

Based on the information given in the table, which of the following conclusions can Siti **correctly** draw?

- A Only cell Q cannot divide.
- B Only cell R can photosynthesise.
- C Only cells P and Q are animal cells.
- D Only cells P and R can control the substances moving in and out of them.

- (1) A and B only
- (2) A and D only
- (3) B and C only
- (4) C and D only

6. Benny recorded the length of a young cockroach until it reached the adult stage. Which one of the graphs shows its changes in length?

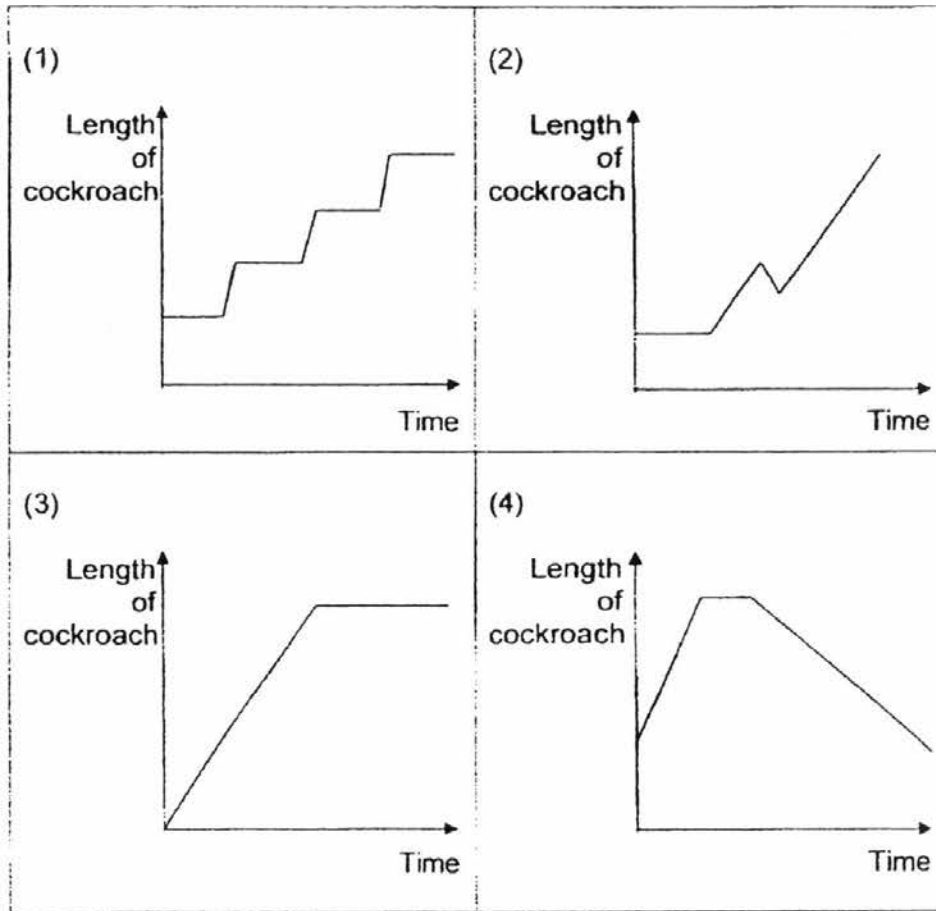

7. The classification chart below shows how some animals are being grouped.

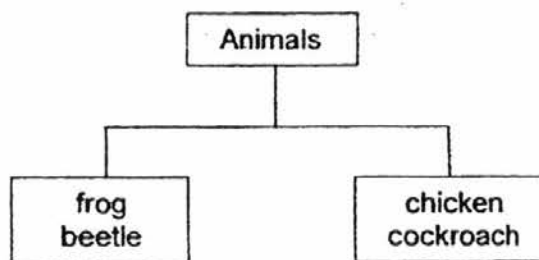

How are these animals grouped?

- (1) animal's body covering
- (2) animal's ability to moult
- (3) resemblance of young to adult
- (4) number of stages in their life cycle

8. Which one of the following shows the life cycle of a flowering plant?

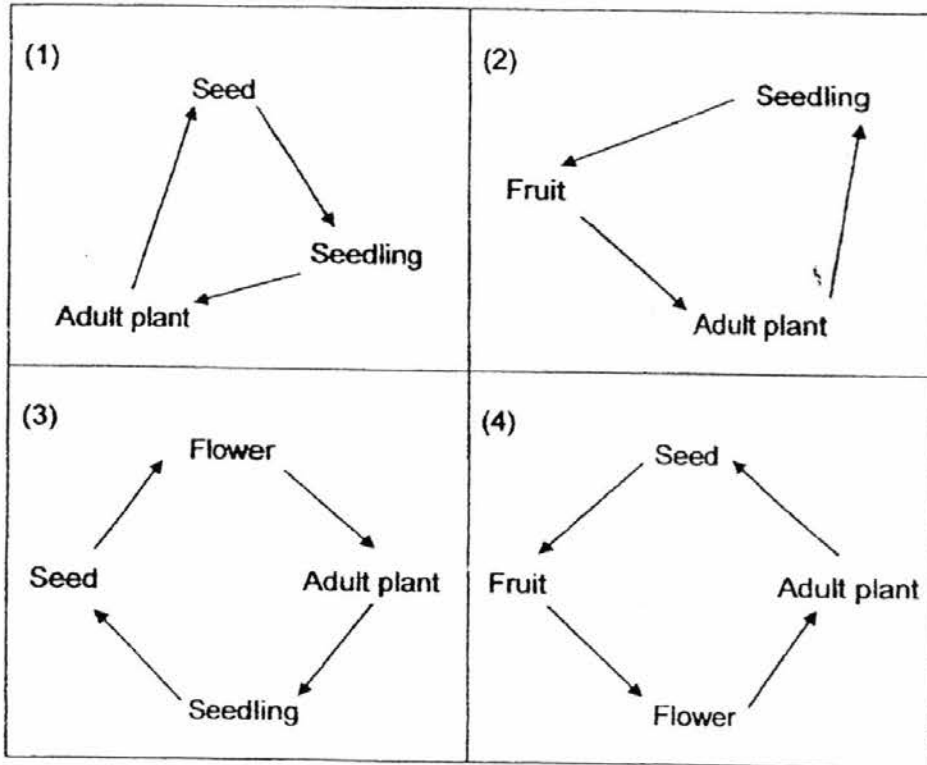

9. The flow chart below shows the movement of different substances as three systems of the human body work together.

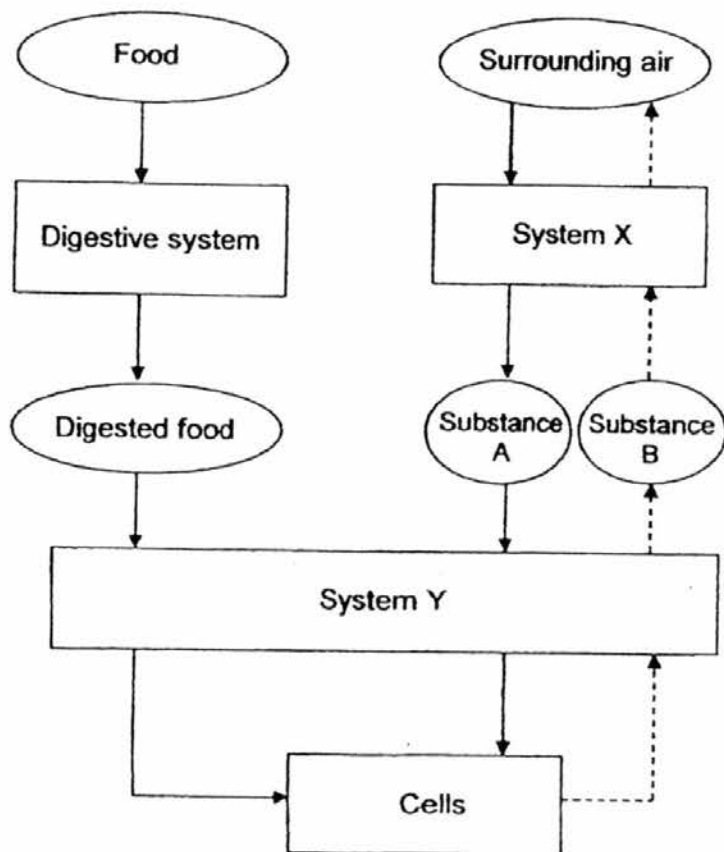

Which one of the following identifies A, B, X and Y **correctly**?

| | A | B | X | Y |
|-----|----------------|----------------|-------------|-------------|
| (1) | oxygen | carbon dioxide | respiratory | circulatory |
| (2) | oxygen | carbon dioxide | circulatory | respiratory |
| (3) | carbon dioxide | oxygen | respiratory | circulatory |
| (4) | carbon dioxide | oxygen | circulatory | respiratory |

10. Four children, Ariel, Bree, Caili and Dinah each made a statement about the way the human digestive system works.

Ariel : Water from the food is absorbed in the large intestine.

Bree : Only undigested food moves into the stomach from the gullet.

Caili : Digested food in the small intestine is absorbed into the bloodstream.

Dinah : Undigested food from the small intestine moves into the large intestine to be digested

Which of the following children have made **correct** statements about how the digestive system works?

(1) Ariel and Caili only

(2) Bree and Dinah only

(3) Ariel, Bree and Caili only

(4) Ariel, Bree, Caili and Dinah

11. On very hot days, Mrs Tan would turn on her fan and place it directly in front of her wet towel to cool down the room.

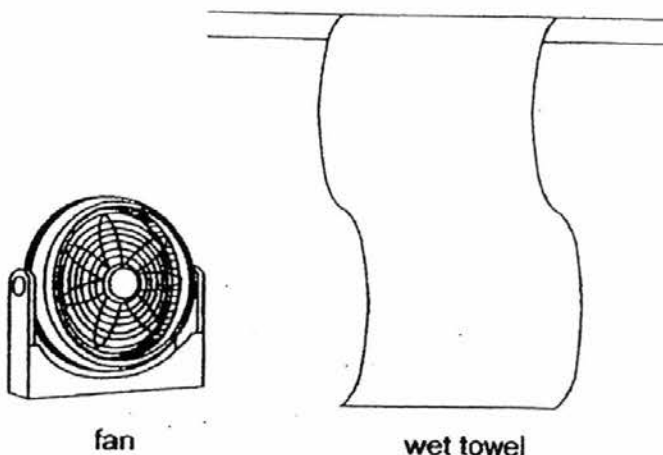

How does this arrangement help to cool down the room?

- (1) The surrounding water vapour condenses slower, causing the wet towel to dry faster.
- (2) The wet towel dries faster because the surrounding water vapour condenses faster.
- (3) The water from the wet towel evaporates faster by gaining heat from the surrounding air faster.
- (4) The water from the wet towel evaporates faster by allowing the surrounding air to gain more heat.

12. Bryan came out from a hot shower and found that the mirror in the bathroom was fogged up.

Which one of these substances had formed on the mirror?

- (1) steam
 - (2) dry ice
 - (3) water vapour
 - (4) water droplets
13. Mdm Chia clamped 3 test tubes filled with the same amount of water at different temperatures. She placed a container below each boiling tube at room temperature as shown in the diagram below.

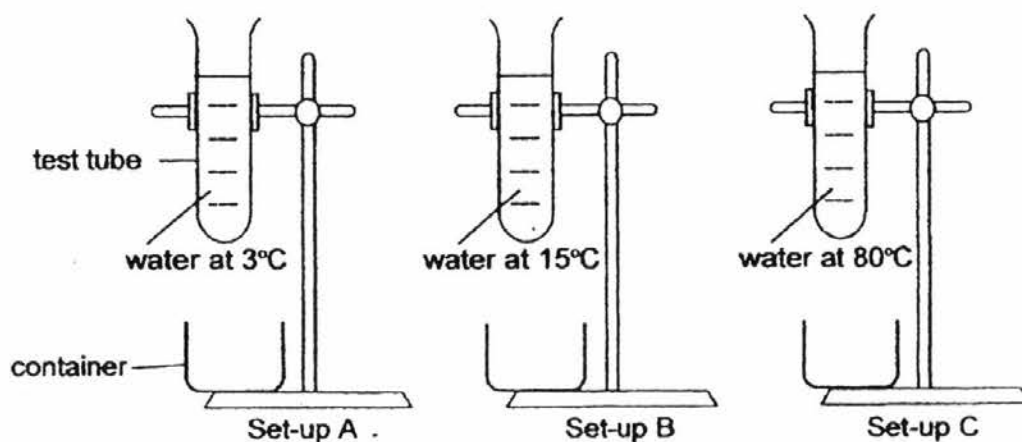

After 20 minutes, she measured the amount of water collected in each container.

In which set-up did she collect the most water?

- (1) Set-up A
- (2) Set-up B
- (3) Set-up C
- (4) None of the above

14. Look at the diagram below.

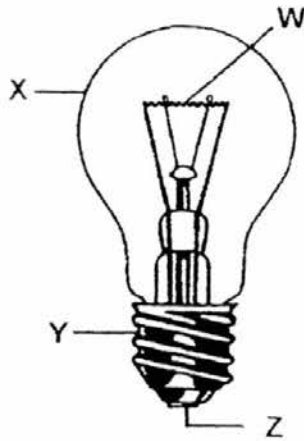

Which parts of the bulb, W, X, Y or Z conduct electricity?

- (1) W and Y only
 - (2) X and Z only
 - (3) Y and Z only
 - (4) W, Y and Z only
15. Sheryl used 6 identical batteries to find out how the number of batteries affects the brightness of a bulb. The graph below shows the results of her experiment.

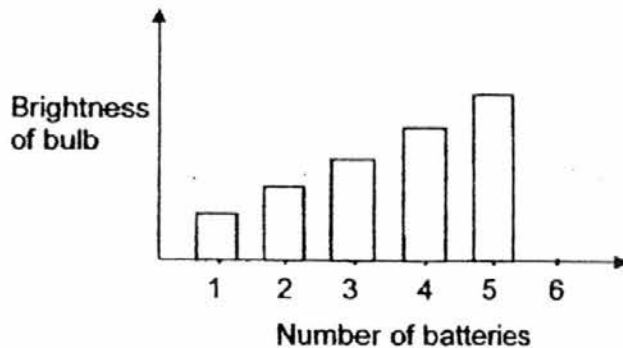

Which one of the following is a **correct** conclusion?

- (1) The bulb becomes less bright when more batteries are added.
- (2) As the number of batteries increases, the bulb become brighter.
- (3) The number of batteries has no effect on the brightness of the bulb.
- (4) The greater the number of batteries, the brighter the bulb up to a maximum of 5 batteries.

16. Nelson was given a battery, a bulb and wire. All the electrical components were working properly. He was asked to connect the three electrical parts in different ways for the bulb to light up. He set up 5 different arrangements, (A – E) as shown below.

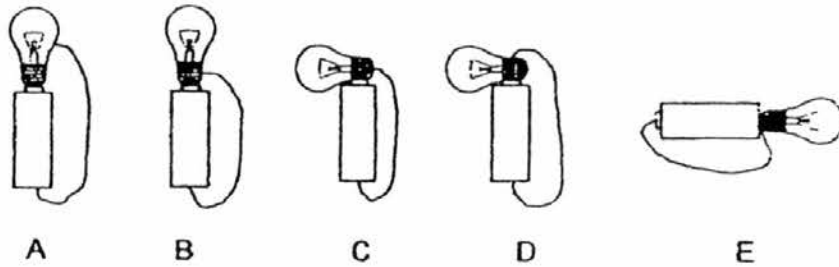

In which of the arrangements would the bulb light up?

- (1) A and B only
 (2) B and C only
 (3) C and D only
 (4) A, B, D and E only
17. Mr Pang set up an electrical circuit as shown in the diagram below. However, the bulb remained unlit.

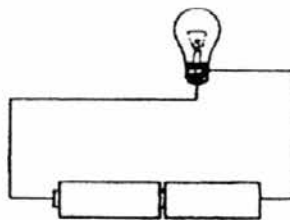

Which of the following could explain why the bulb did not light up?

- A It is a closed circuit.
 B The bulb has fused.
 C The batteries are drained.
 D The components in the circuit are connected wrongly.
- (1) A and D only
 (2) B and C only
 (3) A, B and C only
 (4) B, C and D only

18. Study the circuit diagram shown below.

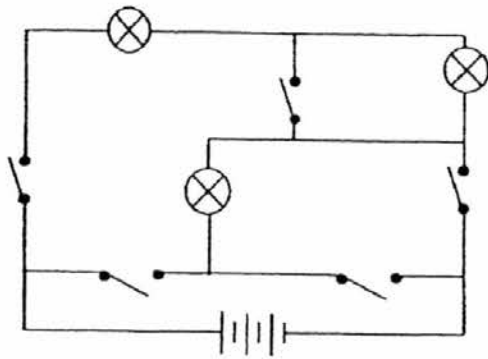

What is the least number of switches that must be closed for **all** the bulbs to light up?

- (1) 1 switch only
- (2) 2 switches only
- (3) 3 switches only
- (4) 4 switches only

19. Elliot made a circuit card with 6 fasteners, A, B, C, D, E and F which are connected on the underside. He connected a circuit tester to 2 of the fasteners at a time and placed a tick whenever the pair of fasteners allowed the bulb to light up.

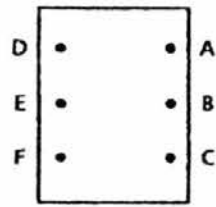

circuit card

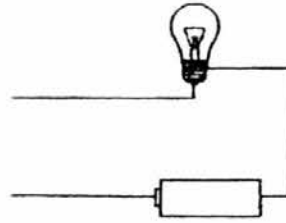

circuit tester

He obtained the following results.

| Fasteners | A | B | C | D | E | F |
|-----------|---|---|---|---|---|---|
| A | | √ | √ | | √ | |
| B | | | √ | | √ | |
| C | | | | | √ | |

Based on his results, which one of the following connections is not possible?

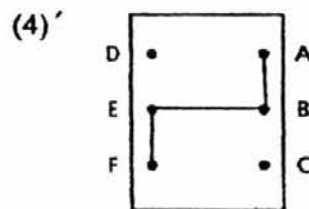
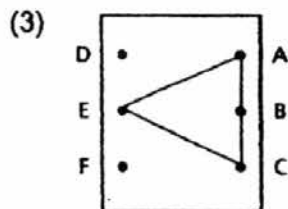
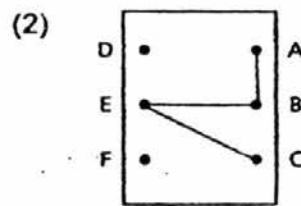
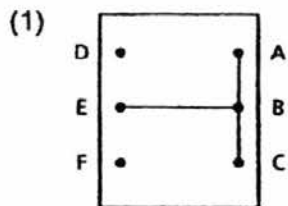

20. Ennie used batteries, bulbs and some wire in an electrical circuit as shown below. All the electrical components were working properly. She placed four materials, rubber, steel, copper and iron, at positions A, B, C and D.

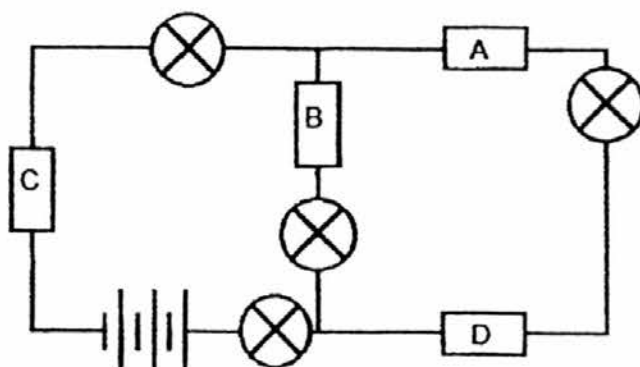

She found that none of the bulbs lit up.

How did Ennie arrange the four materials?

| | | Materials | | | |
|-----|----------|-----------|-------|--------|------|
| | | Rubber | Steel | Copper | Iron |
| (1) | Position | B | C | D | A |
| (2) | | C | A | B | D |
| (3) | | A | D | B | C |
| (4) | | D | C | A | B |

21. The diagram below shows the setup of an electrical doorbell.

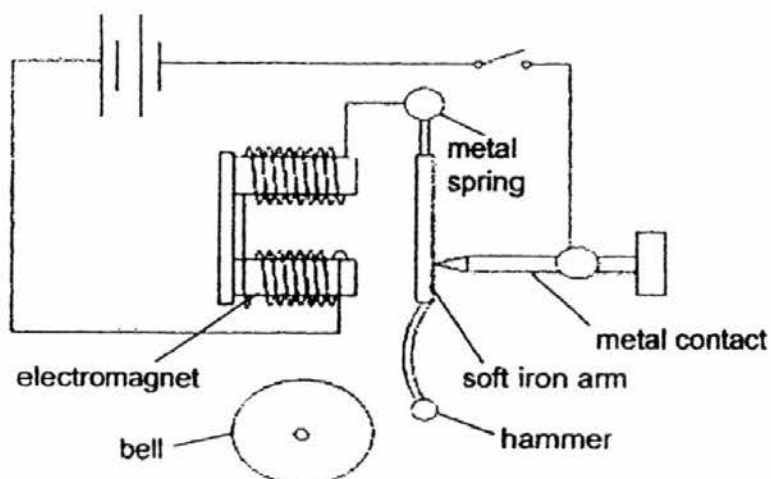

Which one of the following statements is false?

- (1) When the switch is closed, a closed circuit is formed.
 - (2) When the hammer hits the bell, the circuit is already open.
 - (3) In a closed circuit, the electromagnet will pull the soft iron arm towards it.
 - (4) The hammer will only return to its original position when the switch is open.
22. The diagram below shows a socket in Ginny's house.

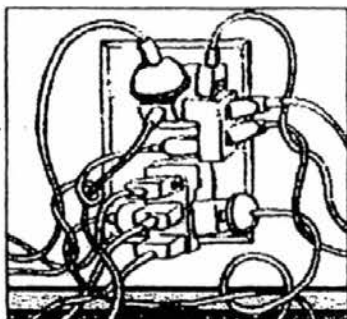

What is/are the disadvantage(s) of connecting multiple plugs to the socket?

- A She may trip over the wires.
B The plugs may get too hot and start a fire.
C Less electricity will be used when she connects the plugs to only one socket.
- (1) C only
 - (2) A and B only
 - (3) B and C only
 - (4) A, B and C

23. Which of the following actions involve **both** a push and a pull?

- A sweeping the floor
- B twisting a towel dry
- C shaking a bottle of drink
- D opening the refrigerator door

- (1) C only
- (2) B and D only
- (3) A, B and C only
- (4) A, B, C and D

24. Which one of the following does not show the effects of forces?

- (1) a pail holding water
- (2) a leaf falling onto the ground
- (3) a caterpillar feeding on a leaf
- (4) a car screeching to a stop at the junction

25. A wheel was rolled from point A to point B in the direction shown by the arrow.

Which one of the following shows the direction of friction acting on the wheel **correctly**?

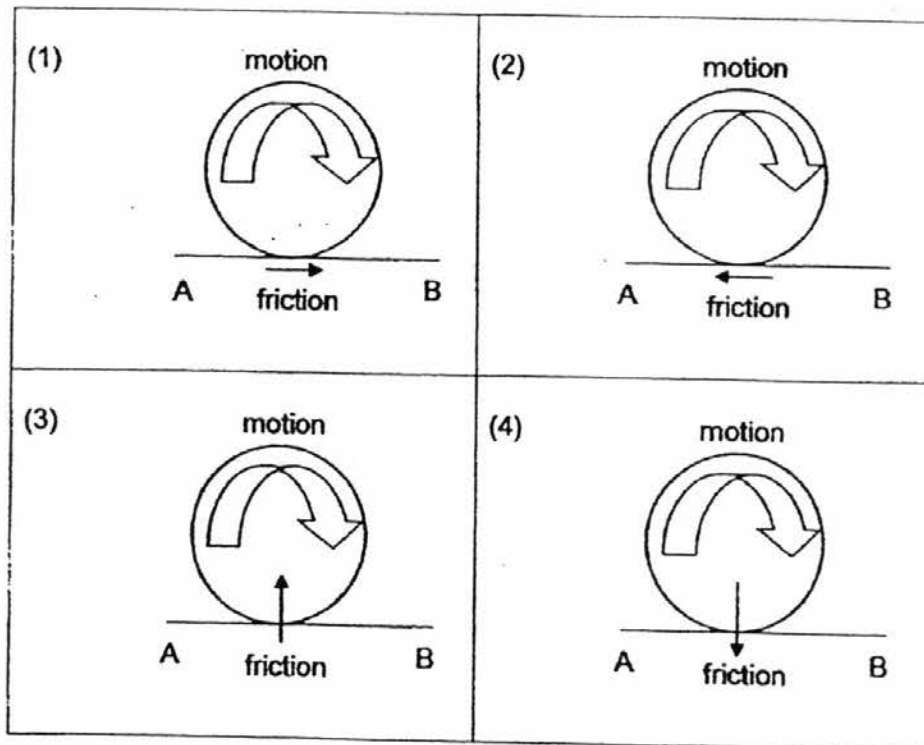

28. Lenny placed two ring magnets, J and K, into the holder at first. He observed distance Y, the gap between the magnets. What would he notice about distance Y if he adds another magnet L to the holder as shown below?

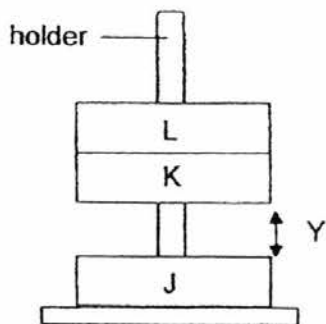

- (1) Y would increase because magnet L is attracted to magnet K.
- (2) Y would remain the same because magnet L is not repelling magnet K.
- (3) Y would decrease because the magnetic forces of repulsion between J and K has to overcome the weight of K and L.
- (4) Y would decrease because the magnetic forces of attraction between K and L is more than the magnetic forces of repulsion between J and K.



NANYANG PRIMARY SCHOOL

PRIMARY 5 SCIENCE

SEMESTRAL ASSESSMENT 2

2016

BOOKLET B

Date : 24 Oct 2016

Duration : 1 h 45 min

Name : _____ ()

Class: Primary 5 ()

Marks Scored:

| | | |
|--------------------|--|------------|
| Booklet A: | | 56 |
| Booklet B : | | 44 |
| Total : | | 100 |

Any query on marks awarded should be raised by 4 Nov 2016. We seek your understanding in this matter as any delay in the confirmation of marks will lead to delays in the generation of results.

Parent's signature:

**DO NOT OPEN THIS BOOKLET UNTIL YOU ARE TOLD TO DO SO.
FOLLOW ALL INSTRUCTIONS CAREFULLY.**

Booklet B consists of 14 printed pages including this cover page.

Section B (44 marks)

Write your answers to questions 29 to 41 in the spaces provided.

29. Mr Lin instructed his pupils to mount some onion cells on a microscope slide.

- (a) Draw one complete cell that should be observed in the box provided below. [1]

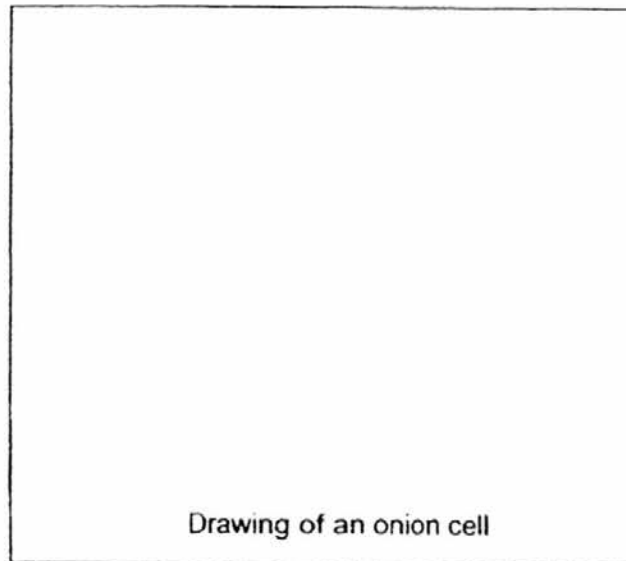

- (b) In your diagram above, **label** the two cell parts (i) and (ii) using X and Y. [2]
- (i) X : a jelly-like substance where cell activities take place
- (ii) Y : controls the movement of substances in and out of the cell

30. The graph below shows the heart rate of Marvin for 40 minutes. He started exercising with a few minutes of warm-up stretches followed by a run around the park.

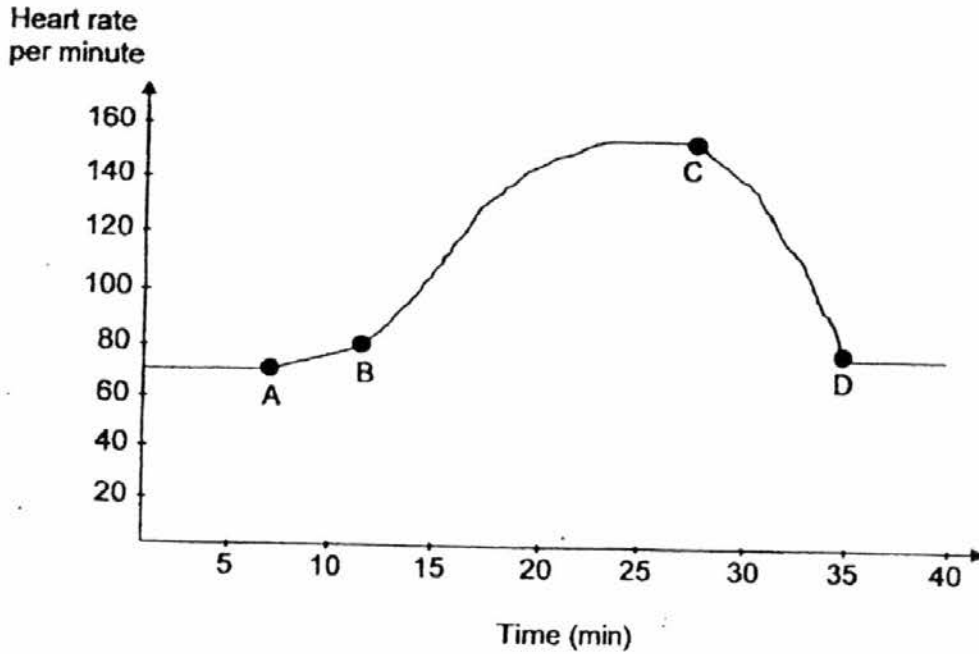

- (a) Based on the graph above, at which point, A, B, C or D did Marvin start running? [1]
-
- (b) Explain your answer to (a). [2]
-
-
-
- (c) Marvin's brother runs more regularly than him and is fitter. If he also ran around the park with Marvin at the same speed, would his heart rate be higher or lower? Why? [1]
-
-

31. Samy conducted an experiment on seed dispersal using a toy he made. He went to the field and released it from where he stood. Next, he measured the distance, d , as shown in the diagram below. He repeated the experiment at the same time for the next two days.

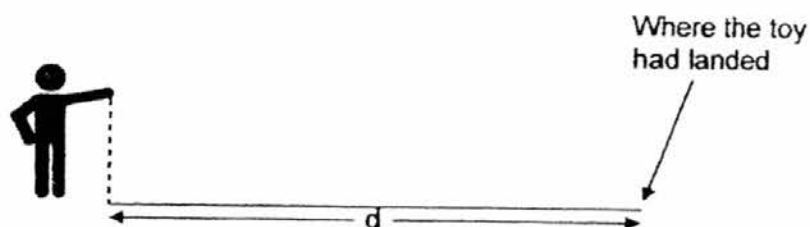

The table below shows the results he recorded.

| Day | d (metre) |
|-----|-------------|
| 1 | 2.6 |
| 2 | 1.8 |
| 3 | 4.2 |

- (a) Based on the results, describe the most likely characteristic of the toy dispersed. [1]
- _____
- (b) Samy concluded that the seeds of a particular tree have similar characteristics as the toy that he had made. How does this characteristic help the tree ensure continuity of their own kind? [2]
- _____
- _____
- (c) Give a possible reason why the result for Day 3 is very different from Day 2. [1]
- _____
- _____
- (d) Samy picked up two other seeds, observed them and concluded on their methods of dispersal. State one characteristic of each seed that correctly led him to his conclusions. [1]

| Method of Dispersal | Characteristic of Seed |
|-----------------------|------------------------|
| (i) Water | |
| (ii) Explosive action | |

32. Lucy studied the life cycle of insect X. She recorded the number of days spent for the four stages of its life cycle. Her results are shown in the graph below.

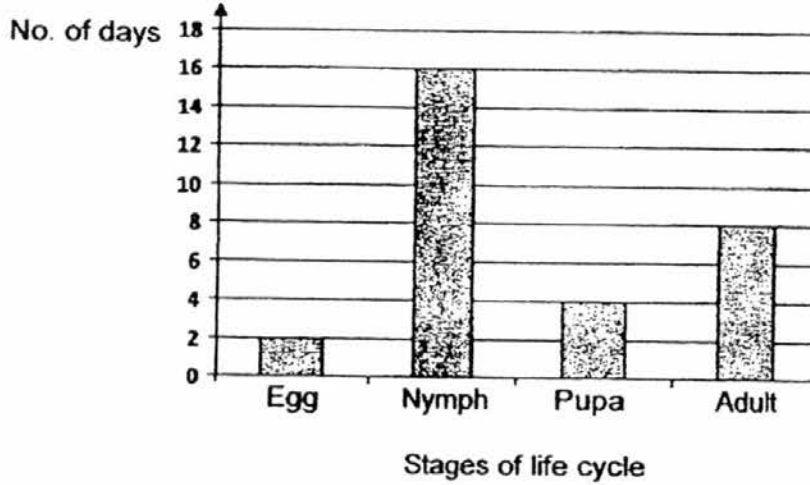

- (a) Lucy's teacher said that she had written the name of one of the stages wrongly. Which is it and what should it be? [1]

The stage that Lucy had written wrongly: _____

The correct name for that stage: _____

- (b) How many days does it take for the young of insect X to grow into an adult from the time it hatches? [1]

- (c) State one difference between the young of an insect with a 3-stage life cycle and the young of another insect with a 4 stage life cycle.

33. The diagram below shows plant K.



- (a) Xiao Long stated that it was an adult plant. Identify one part of the plant that supports his statement. [1]

The diagram below shows the stages in the life cycle of plant K.

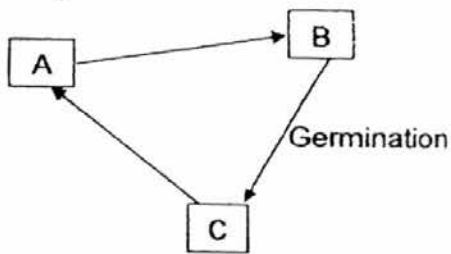

- (b) Which letter represents the stage plant K is at as shown in the diagram above? [1]

Stage _____

The diagram below shows plant K at one of its stages.



- (c) At this stage, how does plant K get its food? [1]

34. The diagrams below show the cross-section of a plant stem and part of a human blood vessel. X, Y and Z are tubes that carry out the function of transportation in the organisms.

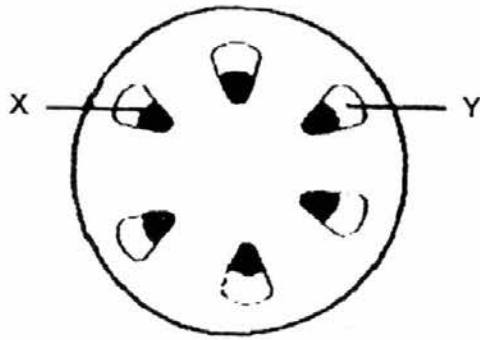

cross-section of a stem

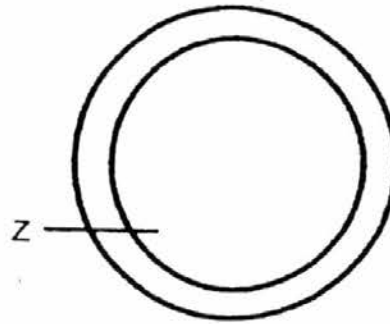

cross-section of a blood vessel

- (a) How are tubes Y and Z similar in the substance(s) that they transport? [1]

- (b) Describe one way in which tubes X and Y are different in the transportation of substances. [1]

35. The diagram below shows the human digestive system.

- (a) Label and name the **three parts** where digestive juices are released. [1]

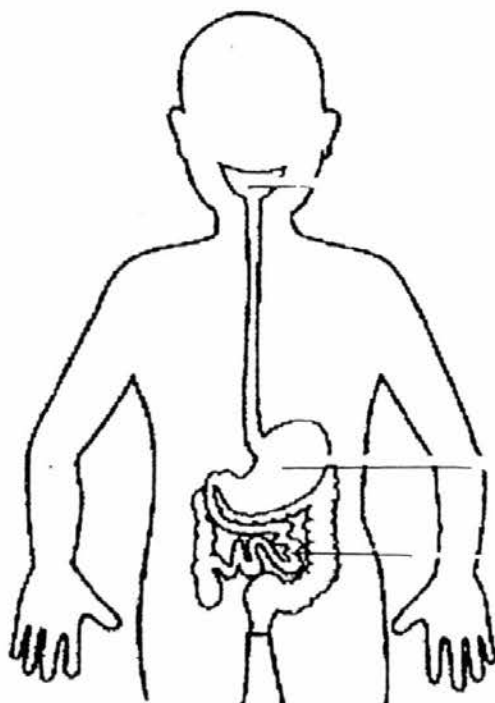

- (b) Digestion is complete in the small intestines.
How does the digestive system work together with the circulatory system in the human body? [2]

36. Judy carried out an experiment using 3 plastic containers, P, Q and R, of different diameters. She poured 500ml of water into each container and left them near the window as shown in the diagram below.

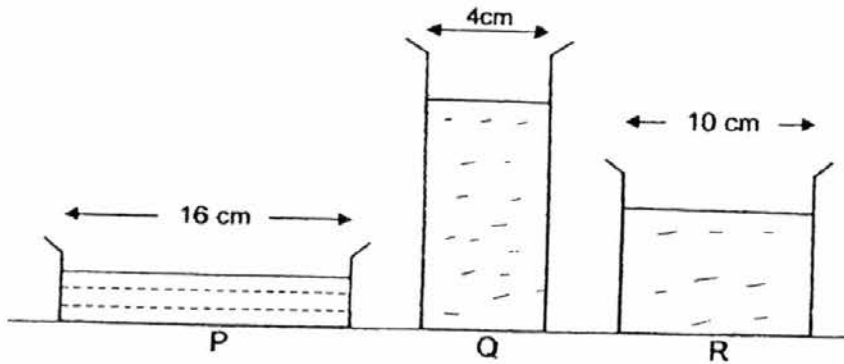

- (a) Draw in the water levels for containers Q and R at the start of the experiment. [1]
- (b) After 12 hours, Judy measured the amount of water left in each container. Based on the set-ups, what was the aim of her experiment? [1]

- (c) Fill in a possible result for container Q after 12 hours. [1]

| Container | P | Q | R |
|----------------------|-----|---|-----|
| Volume of water (ml) | 200 | | 350 |

- (d) Judy commented that if all the containers were placed in a room at 20°C, the water would not evaporate at all. Did Judy make a correct statement? Explain your answer. [1]

37. Siti used batteries, bulbs and some wire to form the circuits X, Y and Z as shown in the diagrams below. All the electrical components were working properly.

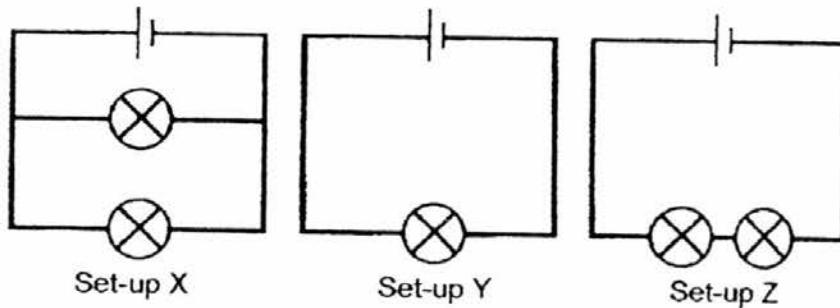

- (a) Which set-up(s) will have the brightest bulb(s)? [1]

- (b) What are two disadvantages of set-up Z compared to set-up X? [2]

- (i) _____

- (ii) _____

38. Barry wanted to investigate whether 4 rods, A, B, C and D were electrical conductors or insulators. He used the circuit shown below.

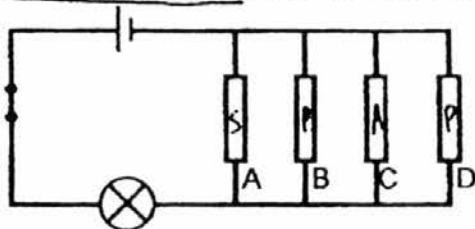

The table below shows what happened when the switch was closed and certain rod(s) was/were removed.

| Rod(s) removed from circuit | Did the bulb light up? |
|-----------------------------|------------------------|
| B | Yes |
| C and D | Yes |
| A, B and D | No |
| B, C and D | No |

- (a) Classify the rods by putting a tick (✓) in the correct column below. [2]

| Rod | Electrical Conductors | Electrical Insulators |
|-----|-----------------------|-----------------------|
| A | | |
| B | | |
| C | | |
| D | | |

Barry replaced the 4 rods with different materials as shown below.

| Rod | Material |
|-----|-----------|
| A | Silver |
| B | Plastic |
| C | Aluminium |
| D | Paper |

- (b) Fill in the new results obtained in the table below. [1]

| Rod(s) removed from circuit | Did the bulb light up? (Yes/No) |
|-----------------------------|---------------------------------|
| B | |
| C and D | |
| A, B and D | |
| B, C and D | |

39. The graph below shows the amount of rainfall in Singapore and the amount of time the air-conditioning unit in Tommy's house was switched on over 6 months.

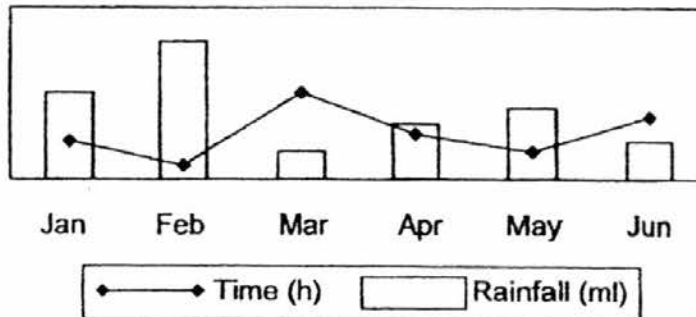

- (a) Based on the graph above, what is the relationship between the amount of rainfall and the number of hours that the air-conditioning unit was switched on? [1]
- _____
- _____
- (b) Based on the graph above, explain why Tommy's usage of electricity for March was the highest. [2]
- _____
- _____
- (c) Besides switching off the air-conditioning unit, suggest two other methods he could use to lower his electrical bill. [2]

- (i) _____
- _____
- (ii) _____
- _____

40. Mrs Lam bought a new pair of shoes and when she brought them home, she immediately stuck an additional rough sole at the bottom of the shoes as shown below.



- (a) Explain using the concept of forces, why Mrs Lam used an additional sole. [2]

- (b) Give a disadvantage of the force mentioned above. [1]

41. Sally attached a rubber duck to a Block R and placed it at one end of a wooden plank as shown below. She then placed Block S 5cm behind Block R.

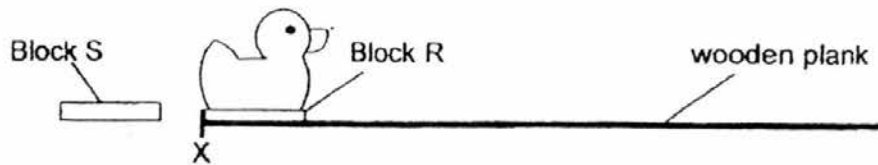

When she moved Block S to point X, the duck would move forward too.

- (a) Explain why the duck is able to move forward even though Block S did not touch Block R. [2]

Sally then placed Blocks R and S at the same starting points again. She measured and recorded d , the distance the duck moved across the plank when she brought Block S to point X, in the table below.

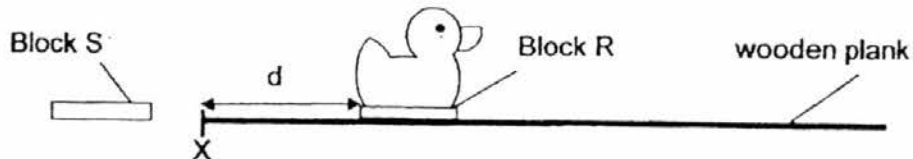

Next, she applied a layer of oil onto the surface of the plank and repeated the experiment.

- (b) Fill in the box below to give a possible distance the duck moved across the plank when oil was applied. [1]

| | Original surface | Oil applied to surface |
|--|------------------|------------------------|
| d , the distance moved by the duck across the plank (cm) | 4 | _____ |

- (c) Give a reason for your answer in (b) [1]

YEAR : 2016
LEVEL : PRIMARY 5
SCHOOL : NANYANG PRIMARY
SUBJECT : SCIENCE
TERM : SA2

Booklet A

| | | | | | | | | | | | | | |
|----|---|----|---|-----|---|-----|---|-----|---|-----|---|-----|---|
| Q1 | 3 | Q5 | 1 | Q9 | 1 | Q13 | 1 | Q17 | 2 | Q21 | 4 | Q25 | 1 |
| Q2 | 4 | Q6 | 1 | Q10 | 1 | Q14 | 4 | Q18 | 2 | Q22 | 2 | Q26 | 2 |
| Q3 | 4 | Q7 | 3 | Q11 | 3 | Q15 | 4 | Q19 | 4 | Q23 | 3 | Q27 | 4 |
| Q4 | 1 | Q8 | 1 | Q12 | 4 | Q16 | 2 | Q20 | 2 | Q24 | 1 | Q28 | 3 |

Booklet B

Q29a & b

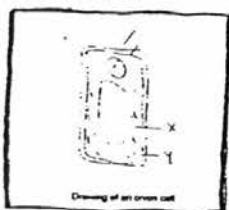

Q30a B

Q30b His heart rate increased the most from point B. More energy is needed when Marvin exercised harder and his heart beat faster to transport more oxygen and digested food to yield more oxygen energy. More carbon dioxide and waste materials had to be removed from the body.

Q30c His heart rate would be lower. Being more fit, his heart can pump blood more efficiently each time as compared to Marvin.

Q31a Wing-like structure.

Q31b They will not be overcrowded and will reduce competition for water, sunlight, space and minerals salts.

Q31c There is more wind blowing the toy in Day 3 than in Day 2.

Q31d

| Method of Dispersal | Characteristic of Seed |
|-----------------------|------------------------------|
| (i) Water | Fibrous husk which traps air |
| (ii) Explosive action | Dry pod |

Q32a The stage that Lucy had written wrongly: Nymph
The correct name for that stage: Larva

Q32b 20 days

Q32c The young of an insect from a 3-stage life cycle resembles the adult but the young of the insect from a 4-stage life cycle does not.

Q33a It has flowers.

Q33b Stage : A

Q33c Seed leaves.

Q34a Tube Y transports food to all parts of the plant and tube Z transports food to all parts of the body.

Q34b Tube X transports water and minerals from the roots to the rest of the plant while tube Y transports food from the leaves to the rest of the plant.

Q35a

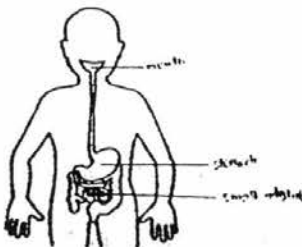

Q35b After digestion is completed in the small intestine, the digested food from the digestive system would be absorbed by the bloodstream and transported to all parts of the body by the circulatory system.

Q36a

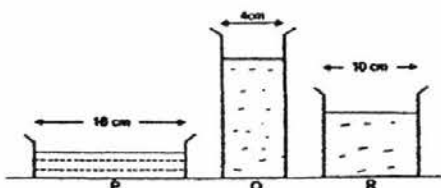

Q36b To find out how the exposed surface area of the water affects the rate of evaporation.

Q36c Q : 400

Q36d No. Water evaporates at any temperature.

Q37a Set-ups X and Y.

- Q37b (i) If one bulb fuses, the other bulb would not light up.
(ii) The light is dimmer for each bulb.

Q38a

| Rod | Electrical Conductors | Electrical Insulators |
|-----|-----------------------|-----------------------|
| A | | ✓ |
| B | ✓ | |
| C | | ✓ |
| D | ✓ | |

Q38b

| Rod(s) removed from circuit | Did the bulb light up? (Yes/No) |
|-----------------------------|---------------------------------|
| B | Yes |
| C and D | Yes |
| A, B and D | Yes |
| B, C and D | Yes |

Q39a The higher the amount of rainfall, the lesser the number of hours that the air-conditioning unit was switched on.

Q39b March has the lowest rainfall so the temperature is the hottest. He used most electricity when he turned on the aircon.

- Q39c (i) Use a fan instead of an air-conditioner.
(ii) Turn off lights when not in use.

Q40a So she would prevent herself from slipping on wet days as there is greater frictional force between the rough sole and the ground.

Q40b It causes things to wear out.

Q41a Both block save magnets and the like poles are facing each other so blocks will repel block R which results in the duck moving.

Q41b Oil applied to surface : 6

Q41c Oil reduces the friction between block R and the plank, so it is able to move further.

End