

Anglo-Chinese School (Junior)



SEMESTRAL ASSESSMENT 1 (2017)

PRIMARY 5

SCIENCE

BOOKLET A

Wednesday

17 May 2017

1 hr 30 min

Name: _____ () Class: 5.(

INSTRUCTIONS TO PUPILS

- 1 Do not turn over the pages until you are told to do so.
- 2 Follow all instructions carefully.
- 3 There are 25 questions in this booklet.
- 4 Answer ALL questions.
- 5 Shade your answers in the Optical Answer Sheet (OAS) provided.

This question paper consists of 20 printed pages (inclusive of cover page).

Booklet A (50 marks)

For each question from 1 to 25, four options are given. One of them is the correct answer. Choose the correct option (1, 2, 3 or 4) and shade the correct oval on the Optical Answer Sheet (OAS).
(25 x 2 marks)

1 Study the classification chart below.

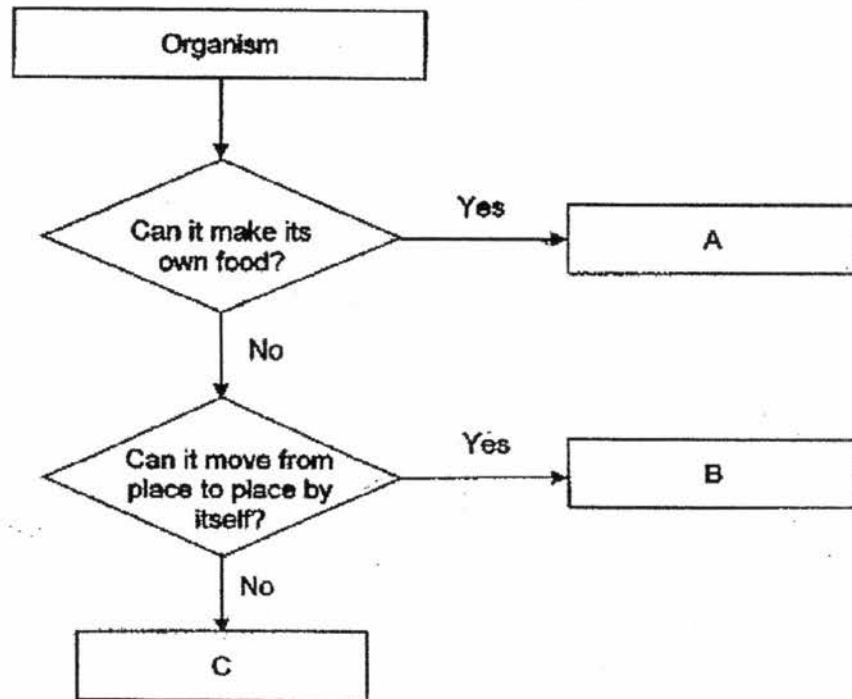

Which of the following can A, B and C be?

	A	B	C
(1)	Fern	Mould	Earthworm
(2)	Mould	Fern	Fungi
(3)	Mould	Fungi	Fern
(4)	Fern	Earthworm	Mould

- 2 Three pupils were arguing among themselves while making comparisons of the following organisms.



Organism A

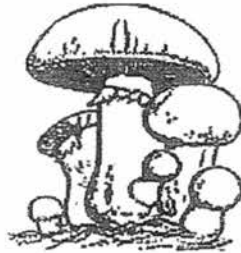

Organism B



Organism C

Each pupil then made the following statements.

Susan: All the above organisms need food to grow.

John: Organisms A and B can move on its own but not organism C.

Dawn: Organisms B and C contain chlorophyll but Organism A does not.

Which of the above pupil(s) had made the correct statement(s)?

- (1) John only
 - (2) Dawn only
 - (3) Susan only
 - (4) John, Susan and Dawn
- 3 Weights are added to 2 rubber bands, A and B. The length of each rubber band, as weights are added to them is shown on the graph below.

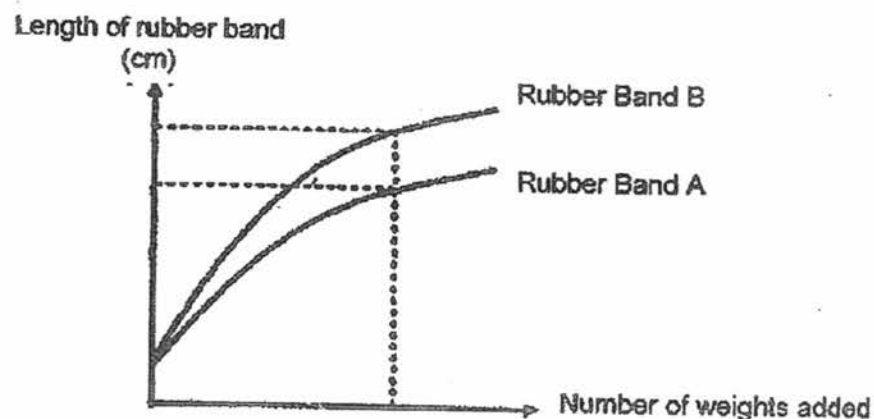

Based on the graph, what can be concluded about the rubber bands A and B?

- (1) Both rubber bands stretch to the same length when the same number of weights is added to each of them.
- (2) B requires more weights to be added before it stretches to the same length as A.
- (3) A requires more weights to be added before it stretches to the same length as B.
- (4) When the same number of weights is added to the rubber bands, A would stretch longer than B.

- 4 The diagram below shows the growth of a bean plant.

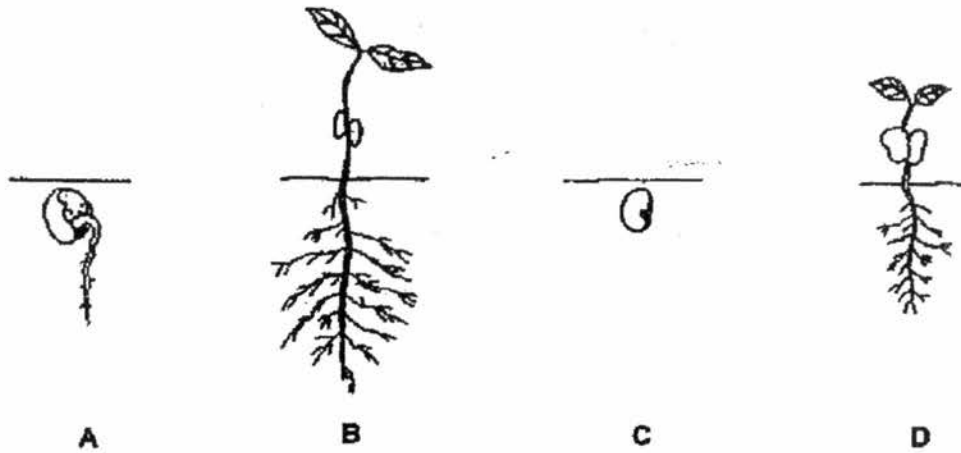

At which point of its growth does the bean plant need sunlight?

- (1) C only
 - (2) A and C only
 - (3) B and D only
 - (4) A, B, C and D
- 5 Study the experiment below.

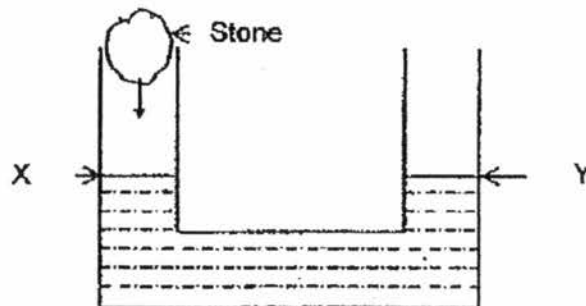

What will happen to the water level at X and Y and the volume of water when the stone is gently dropped into the container?

	Water Level at X	Water Level at Y	Volume of Water
(1)	Increases	Increases	Remains the same
(2)	Decreases	Remains the same	Remains the same
(3)	Increases	Remains the same	Increases
(4)	Decreases	Increases	Increases

- 6 The graph below shows the number of days in each stage of the life cycle of an insect.

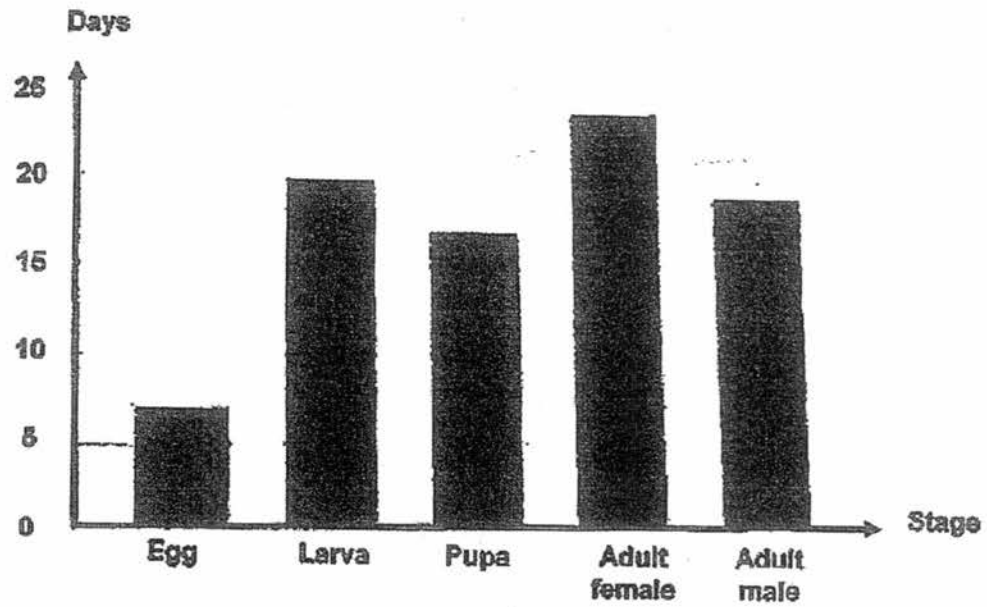

Based on the graph above, which of the following statement(s) is/are true?

- A The insect is a pupa for 20 days.
- B The insect has four stages in its life cycle.
- C There are more male adults than female adults.
- D It takes a shorter time for larva to become a pupa than an egg to become a larva.

- (1) B only
- (2) A and D only
- (3) B and C only
- (4) A, C and D only

- 7 An experiment was conducted with magnets of different sizes as shown in the diagram below.

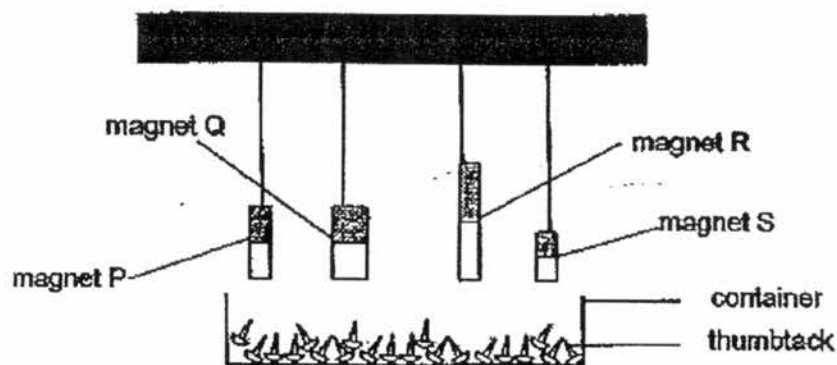

The results of the experiment are recorded in the table below.

Magnet	Number of thumbtacks attracted		
	1 st Attempt	2 nd Attempt	Average
P	4	3	3.5
Q	3	3	3
R	2	1	1.5
S	5	4	4.5

Based on the experiment, what conclusion can be drawn?

- (1) The thumbtacks attracted all the magnets.
 - (2) The poles of all the magnets are equally strong.
 - (3) Magnet S is weaker in magnetism than magnet R.
 - (4) The size of a magnet does not affect its magnetic strength.
- 8 Joan brought a bar magnet close to a small dish of iron nails as shown in the diagram below.

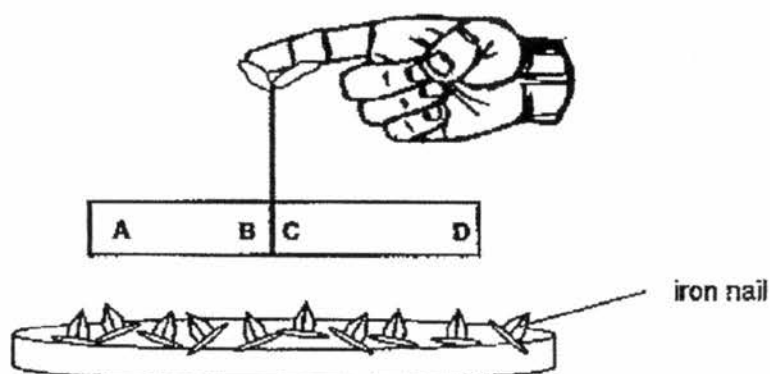

She observed that the magnet attracted the iron nails. Which parts of the magnet would attract the least number of iron nails?

- (1) A and D only
- (2) B and C only
- (3) A, C and D only
- (4) B, C and D only

- 9 The diagram below shows the arrangement of four bar magnets.

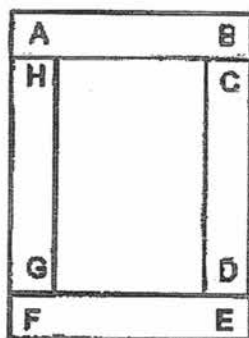

Which of the following arrangements below is possible?

<p>(1)</p>	<p>(2)</p>
<p>(3)</p>	<p>(4)</p>

- 10 Jean carried out an experiment to test the magnetic strength of an iron bar when given a certain number of strokes. She used the North-seeking pole of the magnet to stroke the iron bar in the same direction. She recorded the number of paper clips the iron bar could attract and plotted a graph.

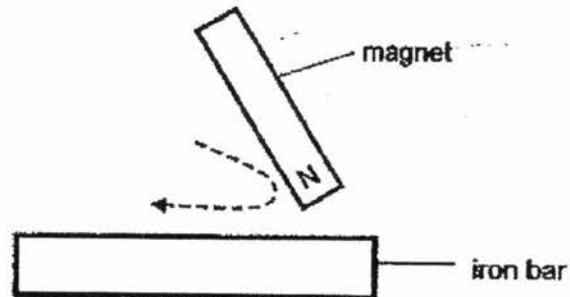

Which one of the graphs best represents the relationship between the number of strokes made and the number of paper clips the iron bar could attract?

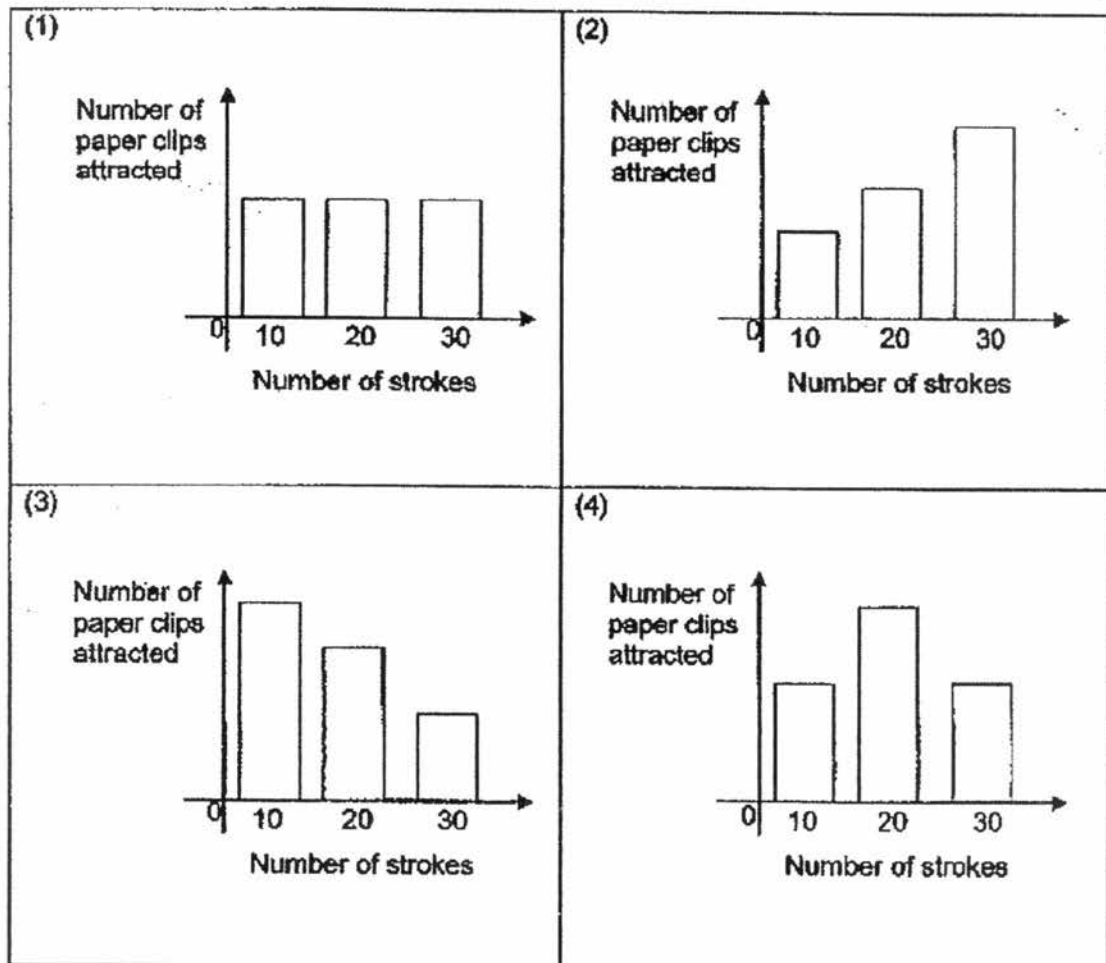

- 11 Study the diagram below. The magnet is glued to the lever and the lever is tilted downwards at the magnet.

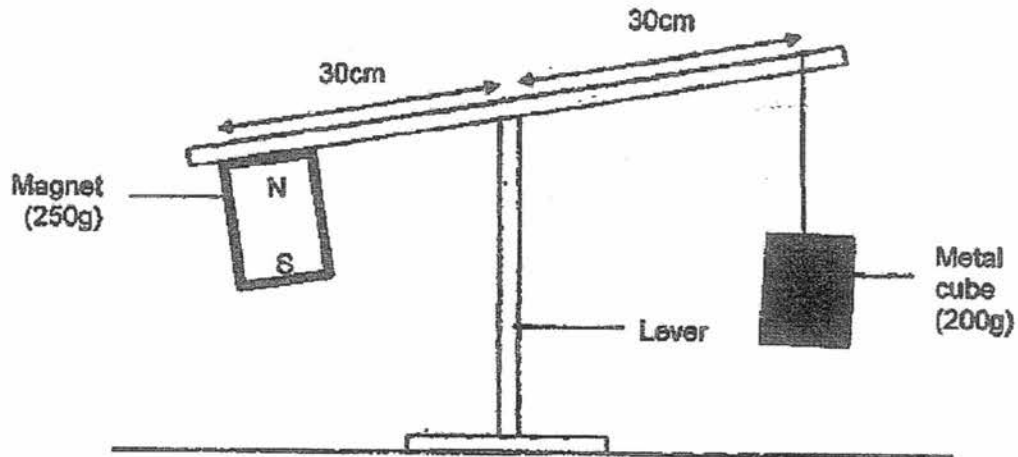

The diagram below shows what happens to the lever when Object X is added to the set-up.

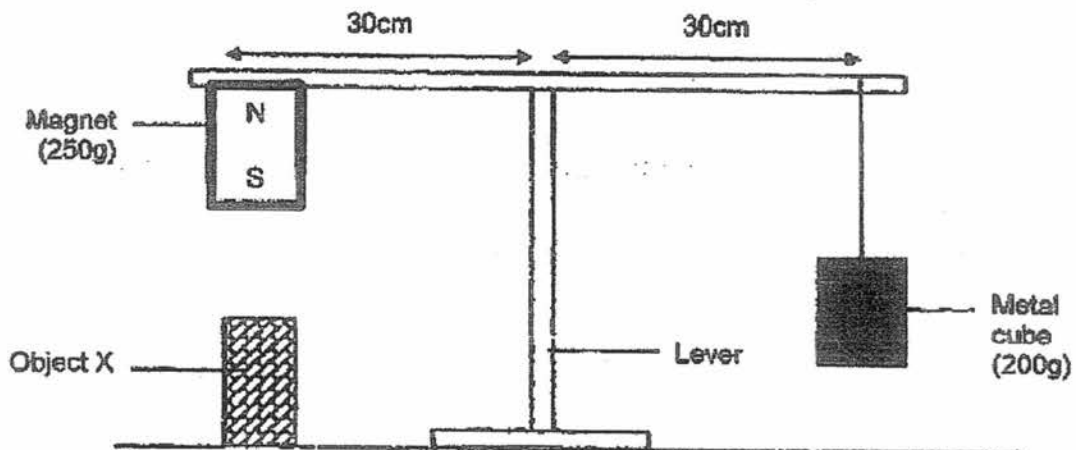

Based on the set-up above, which of the following conclusions about Object X is definitely true?

- (1) It is a magnet.
- (2) It is made of aluminum.
- (3) It is made of a non-magnetic material.
- (4) Object X is attracting the magnet on the lever.

- 12 The diagram below shows the human digestive system of a man. In which of the following parts are digestive juices produced?

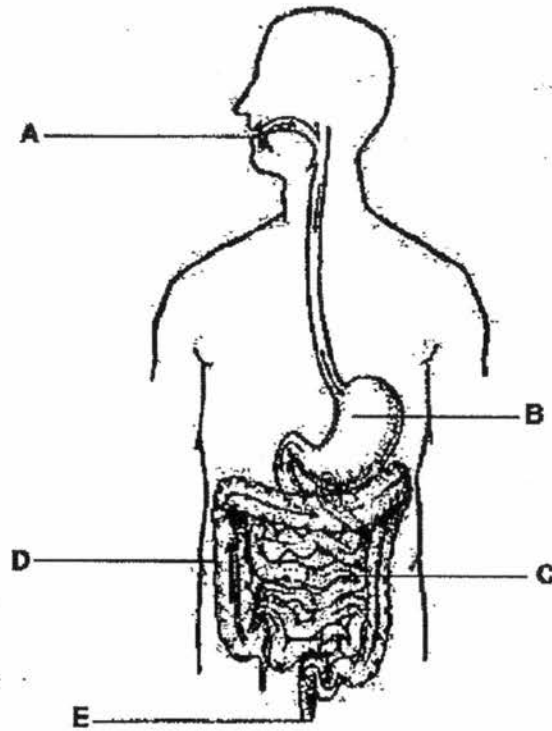

- (1) B and C only
- (2) A, B and C only
- (3) A, D and E only
- (4) A, B, C and D only

13 The diagram below shows a plant.

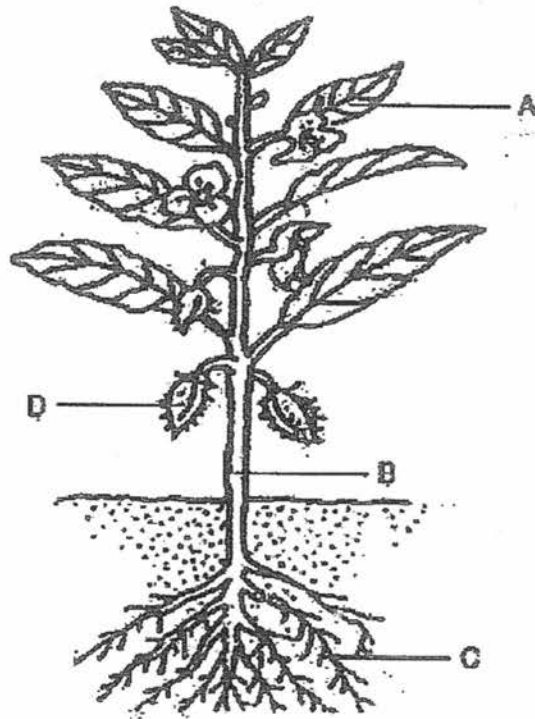

Which of the following identify the parts of the plant to the correct function?

	Makes food for the plant	Anchors the plant firmly to the ground	Holds the plant upright
(1)	D	B	C
(2)	A	B	C
(3)	D	C	B
(4)	A	C	B

- 14 The diagram below shows stomata on the surface of a leaf.



Which of the statements are true about stomata?

- A It traps light for photosynthesis.
- B It can be found on the underside of the leaves.
- C It allows only carbon dioxide to enter the leaves.
- D It allows gaseous exchange to take place with the surroundings.

- (1) A and C only
- (2) B and D only
- (3) A, C and D only
- (4) B, C and D only

- 15 Benjamin was asked to study the diagram of a cell as shown below. He then identified and described the function of four cell parts, A, B, C and D.

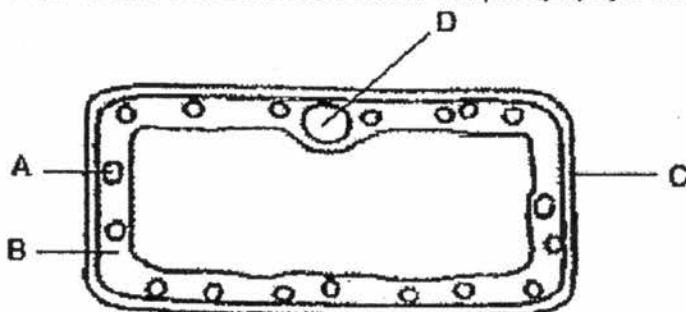

Which of his statement(s) identifies and describes the function of the cell part correctly?

- A C is the cell wall that gives the cell a regular shape.
- B D is a bigger chloroplast that controls all activities in the cell.
- C A is the chloroplast that contains chlorophyll for photosynthesis.
- D B is the cytoplasm that allows only certain materials to move in and out of the cell.

- (1) A only
- (2) A and C only
- (3) B, C and D only
- (4) A, B, C and D

- 16 Jerome places the stem of a plant in a container of water with red food colouring. After two hours, he cuts a section of the stem.

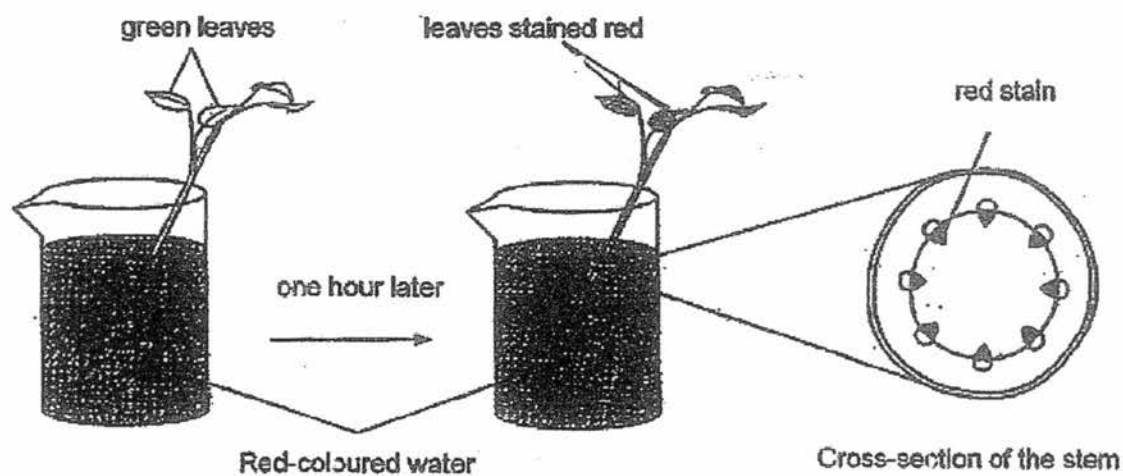

Observe the leaves and the stains on the cross-section of the stem. What can you infer from your observation?

- A The leaves need the red food colouring.
- B The parts of the stem coloured red transport water.
- C The red stains on the leaves are food made by the leaves.
- D The parts of the stem coloured red are connected to the leaves.

- (1) A and B only
- (2) B and D only
- (3) C and D only
- (4) A, B, C and D

- 17 The diagram below represents the human circulatory system. A, B, C and D represent the blood flowing in four different blood vessels in the systems. The arrows represent the direction of blood flow.

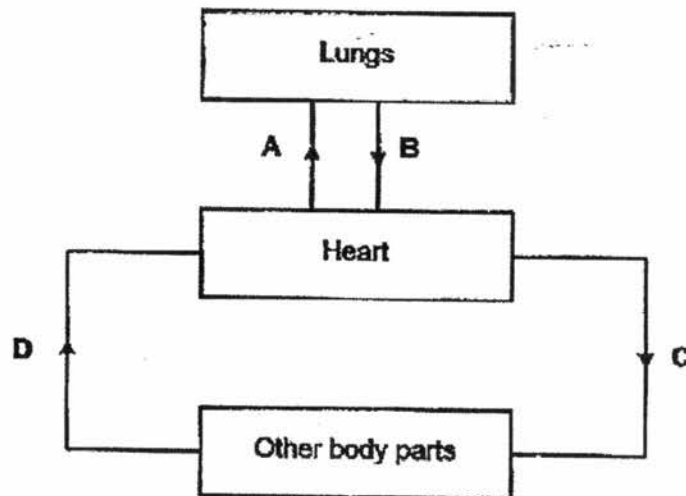

Which one of the following statements is Incorrect?

- A Blood at A is richer in oxygen than Blood at D.
- B Blood at D is richer in carbon dioxide than blood at B.
- C The heart pumps blood to only other parts of the body.
- D Gaseous exchange takes place in both the heart and lungs.

- (1) B only
- (2) B and C only
- (3) A, C and D only
- (4) A, B, C and D

18 The diagrams below show ⁵ circuits, A, B, C, D and E.

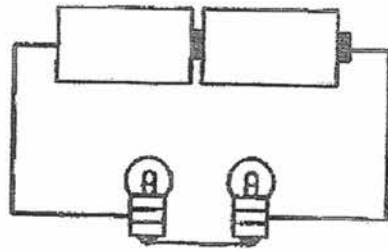

Circuit A

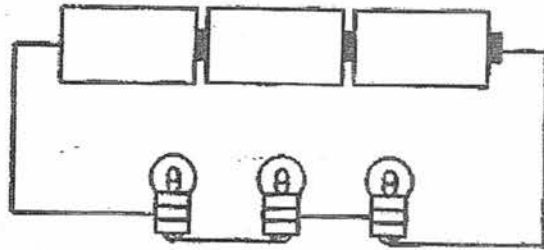

Circuit B

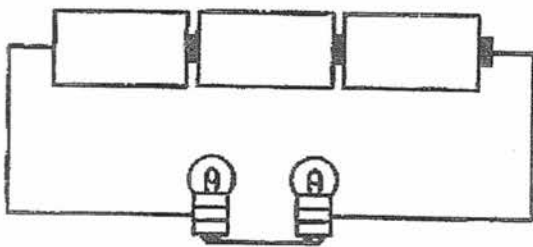

Circuit C

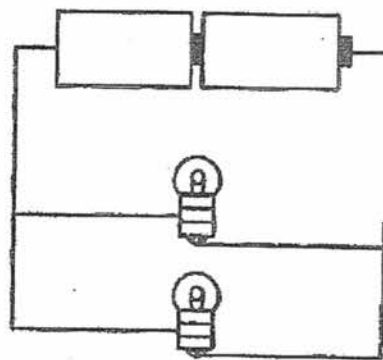

Circuit D

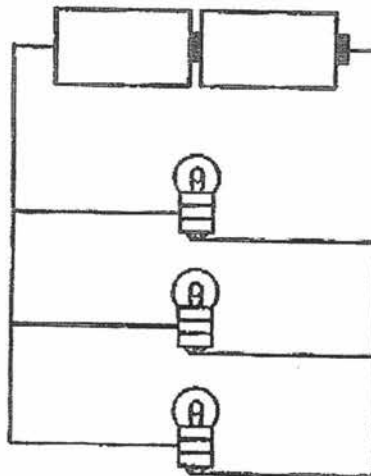

Circuit E

Which of the two circuits can be used to test the effect of the arrangement of bulb(s) on the brightness of the bulb(s)?

- (1) A and E
- (2) A and D
- (3) B and E
- (4) C and D

- 19 Dominic tested the properties of three rods, X, Y and Z using a circuit tester. A tick (✓) indicates that the bulb has lighted up or attracted paper clips. He recorded his results in the table below.

Rods	Bulb lights up	Attracted paper clips
X	✓	✓
Y	x	x
Z	✓	x

Then he used the flow chart as shown below to classify the rods.

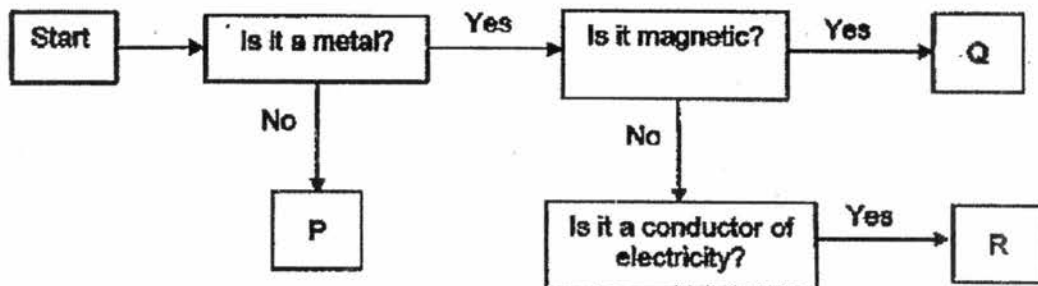

Which of the following letters can be used to represent rods X, Y and Z?

	Rod X	Rod Y	Rod Z
(1)	Q	R	P
(2)	P	Q	R
(3)	R	P	Q
(4)	Q	P	R

- 20 Daniel sets up the circuit as shown in the diagram below. The bulb does not light up.

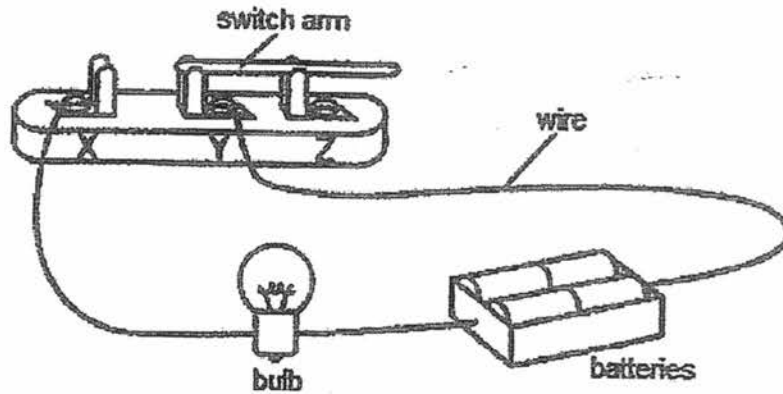

What should he do to make the bulb light up?

- A He should connect the wire to Z instead of Y.
 B He should flip the switch arm to X instead of Z.
 C He should connect the wires to the metal tip and metal casing of the bulb.
- (1) A only
 (2) A and C only
 (3) B and C only
 (4) A, B and C
- 21 Four bulbs, P, Q, R and S, are connected to two batteries as shown below.

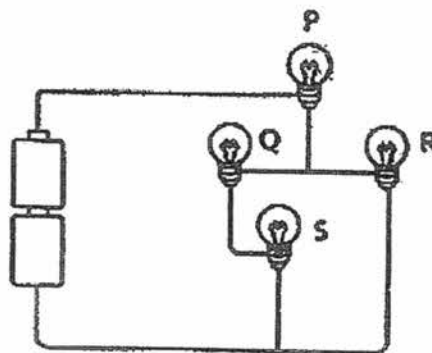

If bulb Q fuses, which bulb/bulbs will still remain lighted up?

- (1) P only
 (2) R and S only
 (3) P and R only
 (4) P, R and S



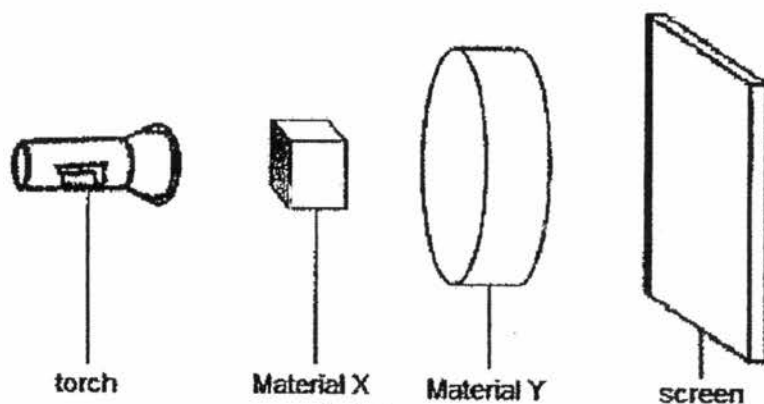

- 22 Evan conducted an experiment using a light sensor and a datalogger. Evan shone the torch on Material X and recorded the amount of light that can pass through. He then shone the torch on Material Y and recorded the amount of light that can pass through.

Material	Amount of light passing through (unit)
X	3000
Y	0

He arranged Materials X and Y in the order as shown below.

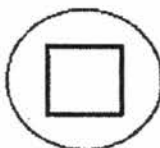

Which of the following is likely the shadow formed on the screen?

- (1) 
- (2) 
- (3) 
- (4) 

- 23 The table below shows the freezing points and boiling points of three unknown substances, P, Q and R.

Substance	Freezing point (°C)	Boiling point (°C)
P	40	85
Q	8	68
R	28	70

Which of the substances, P, Q and/or R, is/are liquid at 75°C?

- (1) P only
 - (2) R only
 - (3) P and Q only
 - (4) Q and R only
- 24 In the diagram below, a T-shaped tube with two drops of ink was attached to a conical flask by a rubber stopper. The flask was then immersed in a tub filled with ice cubes.

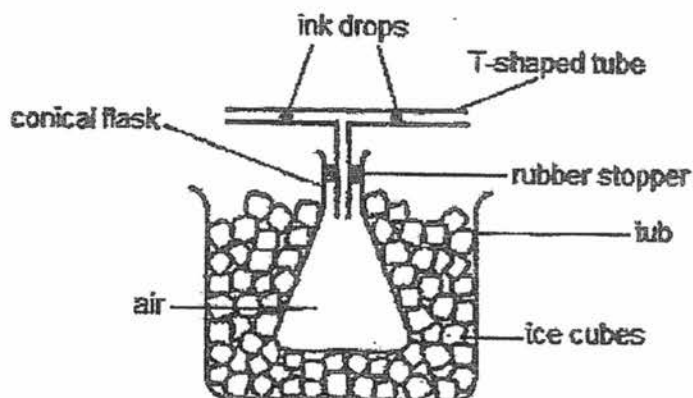

What will happen to the ink drops after 20 minutes?

- (1) The ink drops will gain heat and expand.
- (2) The ink drops will move towards each other.
- (3) The ink drops will move away from each other.
- (4) The ink drops will remain at the same position.

- 25 Beaker A contained 200ml of water with temperature at 50°C. Beaker B contained 200ml of water with a temperature at 90°C. Jayden poured an equal amount of water from Beaker A and Beaker B into Container X.

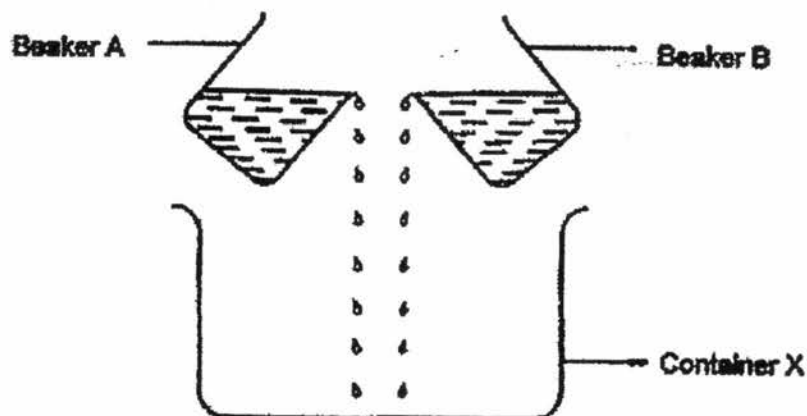

Which of the following statement(s) is/are true?

- A The temperature of water in Container X will be more than 90°C.
 - B The temperature of water in Container X will be less than 90°C but more than 50°C.
 - C The water from Beaker A will gain heat when mixed with the water from Beaker B.
 - D The water in Beaker A contained less heat than the water in Beaker B before they were poured into Container X.
- (1) A and B only
 - (2) B and D only
 - (3) A, C and D only
 - (4) B, C and D only

End of Booklet A

Anglo-Chinese School (Junior)



SEMESTRAL ASSESSMENT 1 (2017)

PRIMARY 5 SCIENCE BOOKLET B

Wednesday

17 May 2017

1 hr 30 min

Name: _____ (Class: 5.)

INSTRUCTIONS TO PUPILS

- 1 Do not turn over the pages until you are told to do so.
- 2 Follow all instructions carefully.
- 3 There are 13 questions in this booklet.
- 4 Answer ALL questions.
- 5 The marks are given in the brackets [] at the end of each question or part question.

Booklet	Possible Marks	Marks Obtained
A	50	
B	40	
PBA	10	
Total	100	

question paper consists of 14 printed pages (inclusive of cover page).

Booklet B (40 marks)

For questions 26 to 36, write your answers in this booklet.

The number of marks awarded is shown in the brackets [] at the end of each question or part question.

- 26 Tom carried out an experiment by putting two identical slices of bread J and K into identical plastic bags at room temperature. He sprinkled some water onto bread K before sealing both plastic bags. The diagram below shows the condition of the two slices of bread after 3 days. He observed mould growing on bread K.

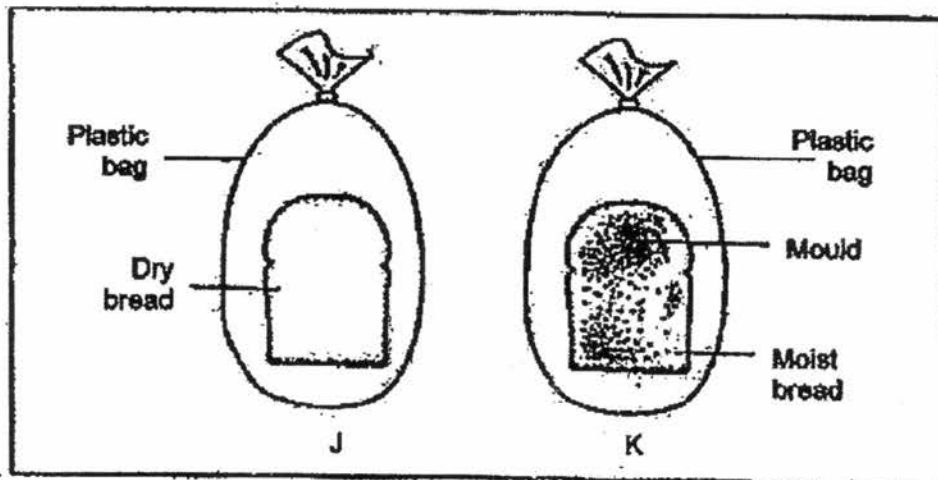

- (a) What was Tom trying to find out from the above experiment? [1]
- _____
- _____
- (b) Where did the mould in the above experiment obtain its food from? [1]
- _____
- _____
- (c) What will be the likely result of Tom's experiment if bread K was placed in the freezer for 2 weeks instead of at room temperature? [1]
- _____
- _____

(Go on to the next page)

SCORE	
	3

27 The diagram below shows the life cycles of two animals, the cockroach and the beetle.

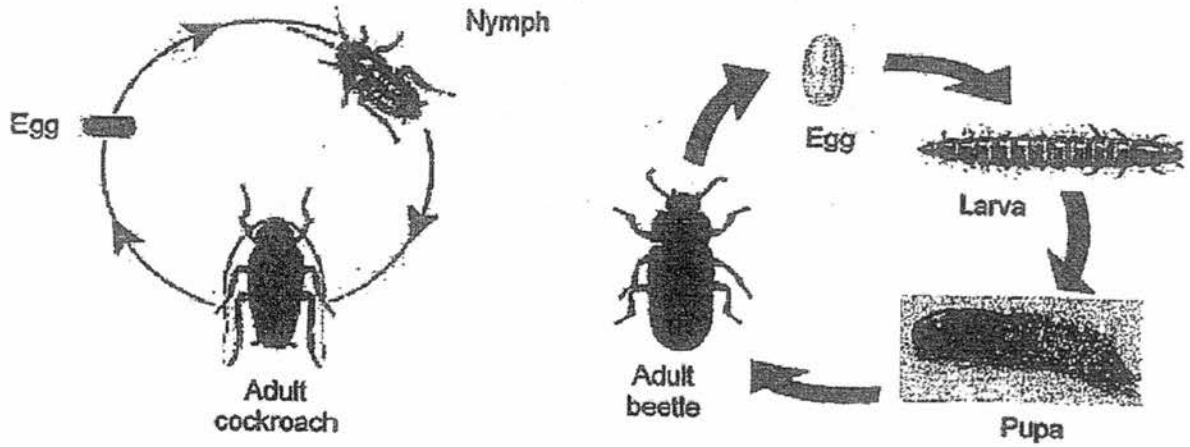

(a) Based on the life cycles above, state one similarity and one difference between the life cycles of both animals. [2]

(i) Similarity:

(ii) Difference:

(b) Name another animal that has the same number of stages in its life cycle as the adult beetle. [1]

(Go on to the next page)

SCORE	
	3

- 28 Mary fills a measuring cylinder completely with sand as shown in the diagram above.

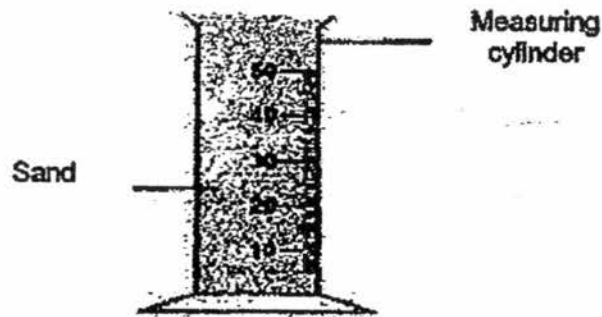

Some water is poured slowly from a beaker into the measuring cylinder until it reaches the brim of the measuring cylinder. When Mary was pouring the water, she noticed some bubbles forming on the surface of the water in the measuring cylinder.

- (a) Identify the state(s) of matter inside the measuring cylinder before Mary poured the water in. [1]

- (b) Explain why bubbles formed on the surface of the water in the measuring cylinder when Mary poured the water in. [2]

(Go on to the next page)

SCORE	3
-------	---

29 Jack set up an experiment as shown below. When he placed a thin piece of sheet X between the magnet and the paper clip, he noticed that the paper clip continued to be suspended in the air.

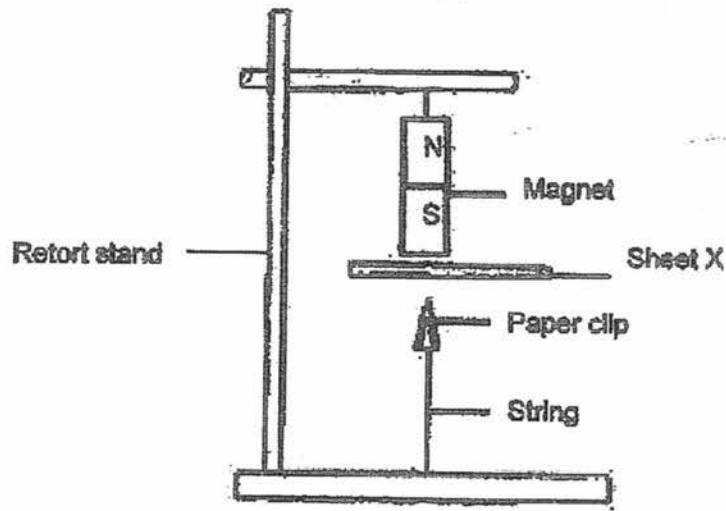

(a) Based on the above experiment, state a property of sheet X. [1]

(b) What material can the paper clip be made of that allows it to be suspended in the air? Explain your choice. [1]

(Go on to the next page)

SCORE	2
-------	---

30 Jack set up an experiment as shown below.

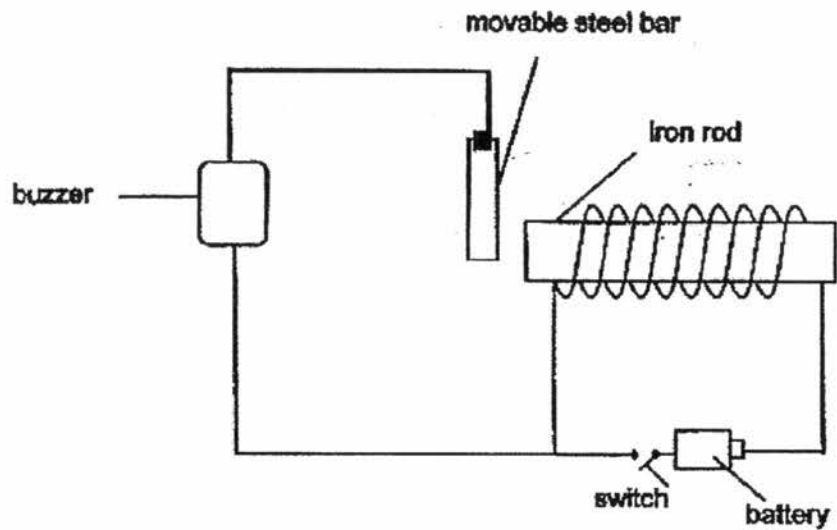

(a) When the switch in the circuit is closed, the buzzer produces a sound. Explain how this happens. [2]

(b) Jack replaced the steel bar with a gold bar. Describe what he would observe. [1]

(Go on to the next page)

SCORE	3
-------	---

31 Gabriel placed two plants in identical containers containing water as shown below. A layer of oil was added to the water in each container. He placed both set-ups in the same location.

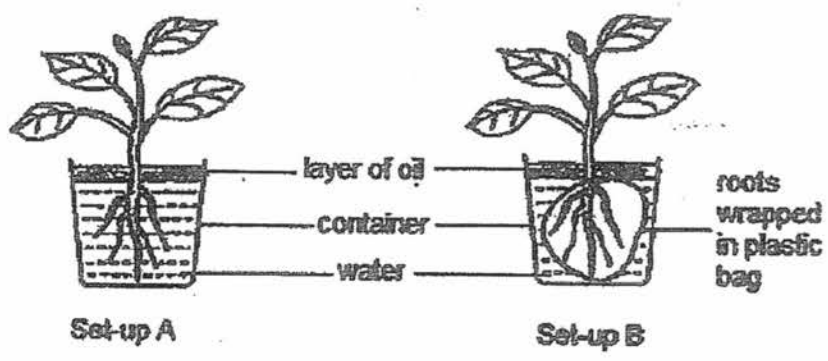

The next day, Gabriel noticed that the water level in Set-up A was lower than the water level in Set-up B.

(a) What was Gabriel trying to find out in the experiment? [1]

(b) State two other variables Gabriel must keep constant in order for his experiment to be a fair one. [1]

(Go on to the next page)

SCORE	
-------	--

- 32 The arrows in the diagram below shows the movement of substance X in the plant.

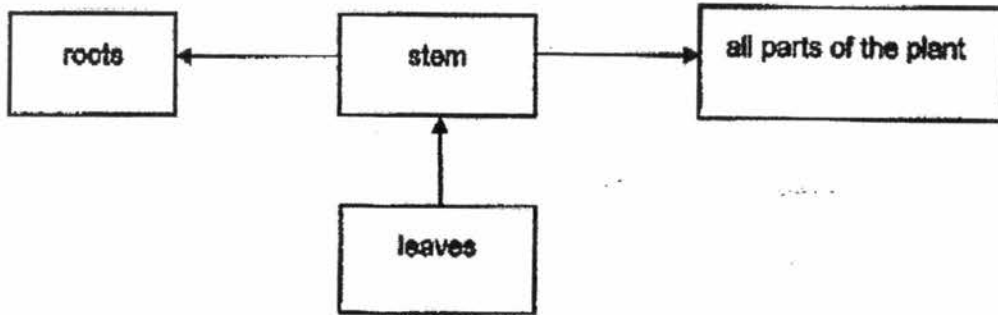

- (a) What is substance X?

[1]

- (b) Jack had an apple tree in his garden. It was observed that part of the tree was destroyed by pests soon after.



The part of the trunk above the destroyed bark became swollen.

Based on the diagram above, explain why the part of the trunk became swollen. [2]

(Go on to the next page)

SCORE	3
-------	---

33 In the lungs, the air tubes branch into tiny tubes that end in air sacs. The air sacs are surrounded by tiny blood vessels. The exchange of gases in the lungs takes place between the air sacs and the blood vessels.

The diagram below shows a section of an air sac in a lung of a human.

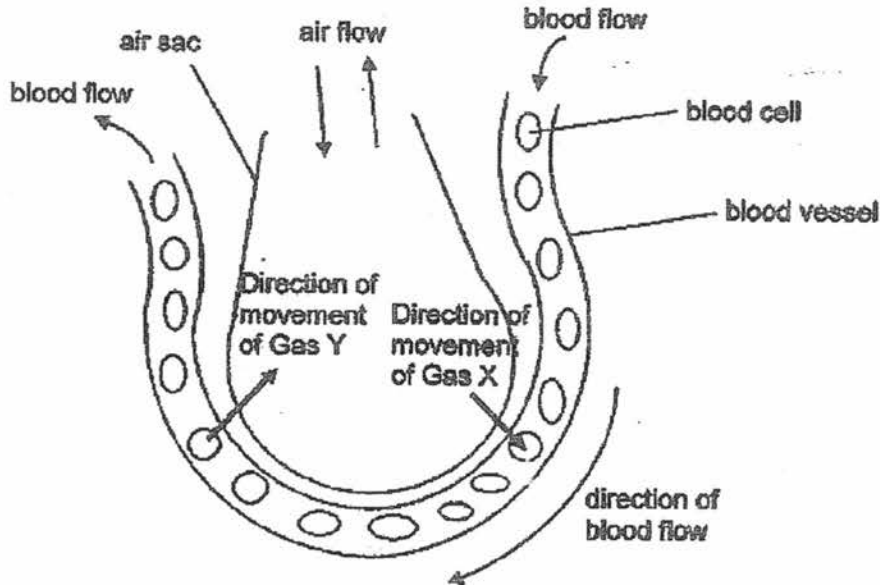

The diagram shows that Gas X leaves the air sac and enters the blood vessel and Gas Y enters the air sac and leaves the blood vessel.

(a) Name both Gas X and Gas Y. [1]

Gas X: _____

Gas Y: _____

(b) Other than Gas X and Gas Y, name two other substances that will be transported in the blood in the human organ systems. [1]

(c) Mr Tan is seated on the sofa reading newspapers. Name two outdoor activities that will increase the rate of exchange of gases in his lungs. [1]

(d) Why does Mr Tan's heart need to pump faster during these two outdoor activities? [1]

(Go on to the next page)

SCORE	
	4

34 Study the flowchart given below carefully.

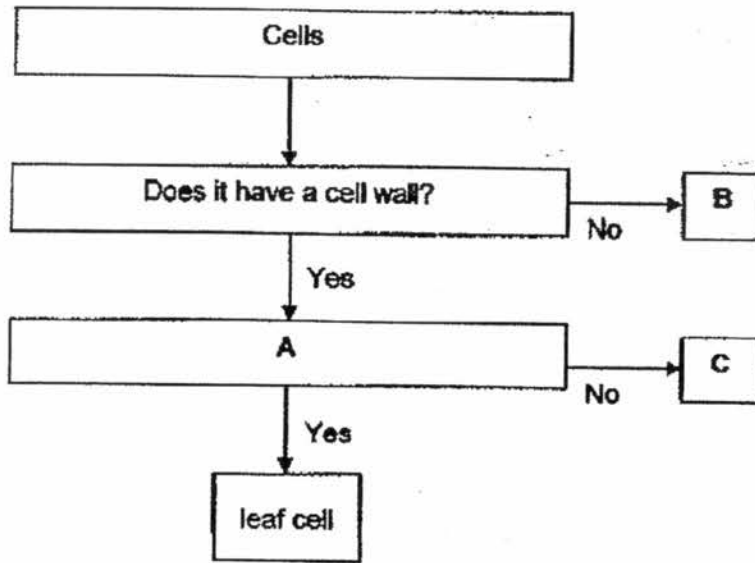

(a) Is B an animal cell or plant cell? Explain your answer. [1]

(b) Complete the flowchart. Write a suitable question for A. [1]

(c) Give an example of C and explain your answer. [1]

(d) What are the similarities in the cell structure of B and the leaf cell? [1]

(Go on to the next page)

SCORE	4
-------	---

35 Denzel set up two circuit diagrams, A and B as shown below.

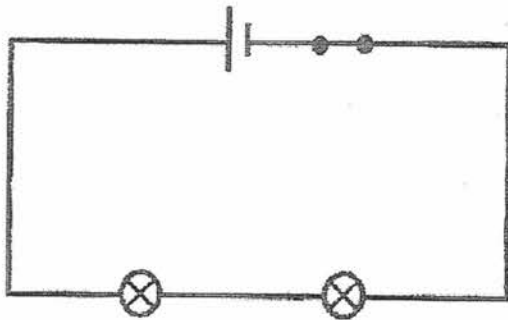

Circuit A

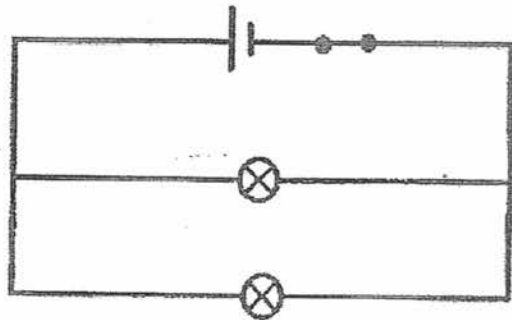

Circuit B

The graph below shows the relationship between the number of batteries and the brightness of the bulbs based on the above set-ups.

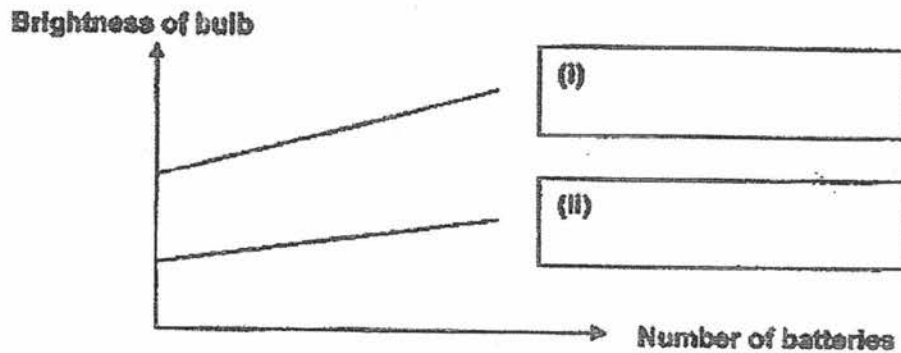

(a) In the graph above, match the line graphs to Circuit A and Circuit B. Write Circuit A and Circuit B in the boxes next to (i) and (ii). [1]

(b) What can Denzel do to make the bulbs in Circuit B brighter? [1]

(c) Explain clearly what can be done to Circuit B if he wants to control the light bulbs individually. [1]

(Go on to the next page)

SCORE	3
-------	---

- (d) In the diagram below, draw in the wires to show how you can connect the batteries and the bulbs so that the bulbs will light up the brightest. [1]

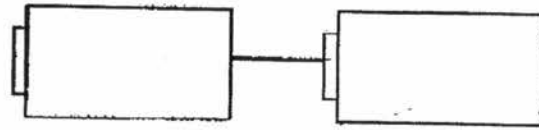

- (e) What will happen to your circuit in (d) if one of the bulb fuses? [1]

36 Look at the two circuits shown below.

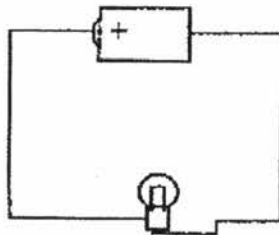

Circuit A

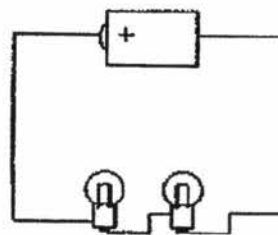

Circuit B

- (a) In which circuit will the bulbs light up more brightly? Give a reason for your answer. [1]

- (b) Give one disadvantage of arranging the bulbs in the way as shown in Circuit B. [1]

(Go on to the next page)

SCORE	4
-------	---

37 Jonathan wanted to find out which material loses heat the fastest. He conducted an experiment on containers made of different material (X, Y and Z) and filled each with the same amount of water at the same temperature. He placed all the containers at the same location.

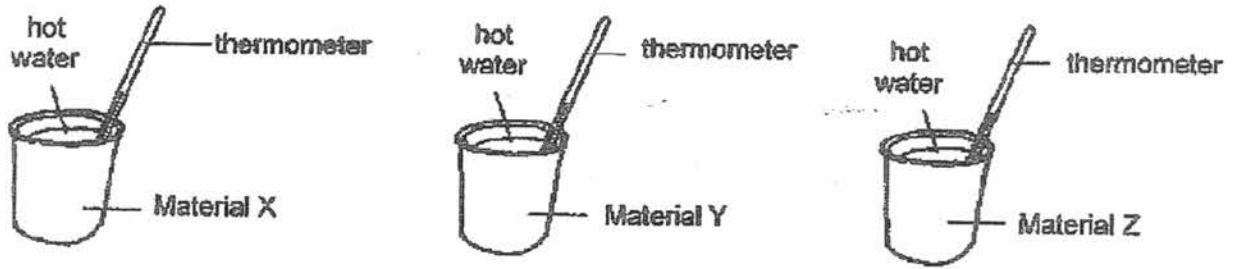

The temperatures in each container were taken at five-minute intervals and recorded in the graph below.

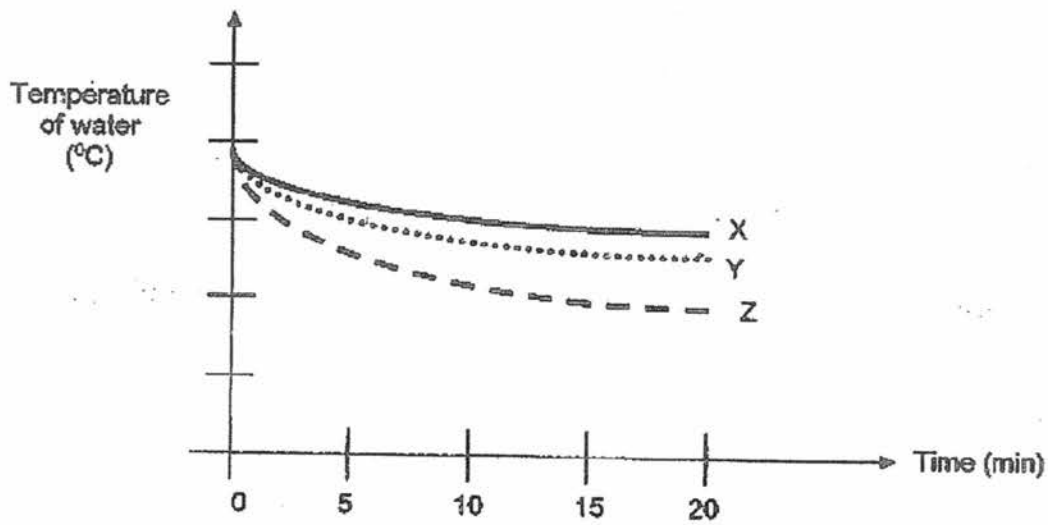

(a) Which material is the best conductor of heat? Explain your answer. [1]

(b) Based on the experiment, which material is the most suitable for making containers to keep ice-cream cold for the longest period of time? Explain your answer. [2]

(Go on to the next page)

SCORE	3
-------	---

- 38 Jonas conducted an experiment to find out about the heat conductivity of different materials. He placed some wax at the top end of 3 rods made of different materials, A, B and C. The three rods were then placed on top of a hot plate as shown below.

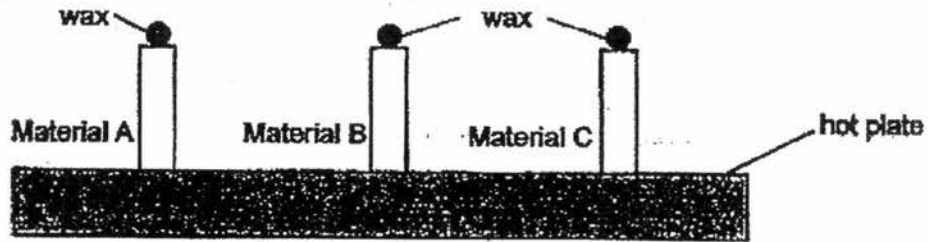

He recorded the time taken for the wax to melt completely at the top end of each rod and recorded them in the table below.

Materials	A	B	C
Time taken (min)	16	4	22

- (a) What can Jonas conclude about the heat conductivity of materials A, B and C? [1]

- (b) List 2 other variables that Jonas needs to keep constant to ensure that the experiment is fair. [1]

- (c) The diagram below shows a frying pan.

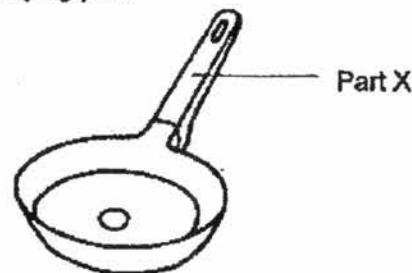

- Based on the results of the experiment, which material is most suitable for making Part X of the frying pan? Explain your answer. [1]

End of Paper

SCORE	3
5	

SCHOOL : ANGLO-CHINESE PRIMARY SCHOOL
 LEVEL : PRIMARY 5
 SUBJECT : SCIENCE
 TERM : 2017 SA1

SECTION A

Q 1	Q2	Q3	Q4	Q5	Q6	Q7	Q8	Q9	Q10
4	3	3	3	1	1	4	2	4	2

Q 11	Q12	Q13	Q14	Q15	Q16	Q17	Q18	Q19	Q20
1	2	4	2	2	2	3	2	4	3

Q 21	Q22	Q23	Q24	Q25			
3	2	1	2	4			

SECTION B

Q26)	(a) Tom was trying to find out if mould needs water. (b) The mould obtains its food from the moist bread. (c) Bread k will not have mould growing on it.
Q27)	(a) (i) Both have egg-stage. (ii) A cockroach has 3-stage lifecycle while a beetle have a 4-stage life cycle. (b) Butterfly
Q28)	(a) Gas and solid. (b) As the sand is a solid, it has a fixed shape. It will not occupy the air spaces in between. When water was poured in, the water will occupy the space previously occupied by air, water poured in fills the spaces previously occupied by air, air then escapes and bubbles are formed.
Q29)	(a) It allows magnetic force to pass through. (b) Cobalt. It is a magnetic material, the magnet will attract the paper clip and therefore the paper clip will be suspended in the air. (note: paper clip can be made of any magnetic material, as magnetic material can be attracted to the magnet)
Q30)	(a) When the switch in the circuit is closed, the battery will let the electricity

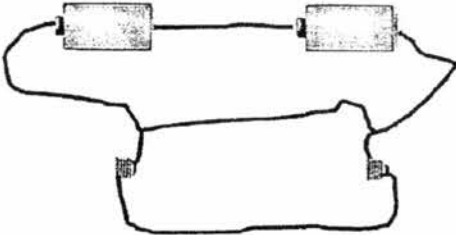
	<p>flow to the wire, the wire coiled around the iron rod will allow the iron bar to be a partial electro-magnet, the iron will then attract the movable steel bar and now electric current could flow to the buzzer and the buzzer will produce a sound as there is a closed circuit.</p> <p>(b) The iron rod would not attract the gold bar and therefore the buzzer will not produce any sound.</p>
Q31)	<p>(a) If the roots absorb water.</p> <p>(b) The plant must be of the same type. The amount of water must be the same.</p>
Q32)	<p>(a) Food.</p> <p>(b) As one part of the phloem was removed, the food made by the leaves was not able to be transported to the lower part of the plants as the food-carrying tube (phloem) was destroyed.</p>
Q33)	<p>(a) Oxygen, Carbon dioxide</p> <p>(b) Digested food and water.</p> <p>(c) Running or swimming.</p> <p>(d) To pump blood that has more digested food and oxygen.</p>
Q34)	<p>(a) Animal cell. It does not have a cell wall.</p> <p>(b) Does it have chloroplast?</p> <p>(c) Root cell. It does not need chloroplast as it does not make food.</p> <p>(d) Both have nucleus, cell membrane and cytoplasm.</p>
Q35)	<p>(a) (i) Circuit B (ii) Circuit A</p> <p>b. Add more batteries</p> <p>c. A switch could be placed on both right side of the bulb</p> <p>d.</p> <div style="text-align: center;">  </div> <p>e. The other bulb will not light up.</p>
Q36)	<p>(a) Circuit A. Both circuits have one battery but there is only one bulb in circuit A and there are 2 bulbs in circuit B. Hence circuit A need not share the electricity.</p> <p>(b) If one of the bulbs fuses, the other bulb will not light up.</p>
Q37)	<p>(a) Z. It allows heat lost in the shortest amount of time.</p> <p>(b) X. It is the poorest conductor of heat and the ice-cream will gain the least heat.</p>
Q38)	<p>(a) B is the best conductor of heat, A is the second best conductor and C is the worst conductor of heat.</p> <p>(b) The wax must be of the same kind. The rods must be of the same height.</p> <p>(c) C. It took the longest time to gain heat so it is the poorest conductor of heat.</p>