

RIVER VALLEY PRIMARY SCHOOL
CONTINUAL ASSESSMENT 2 / 2017
PRIMARY 5

STANDARD SCIENCE

(BOOKLET A)

Name : _____ ()

Date : 16 Aug 2017

Class : P5 _____

Total Time for Booklet A & Booklet B : 1 hour

INSTRUCTIONS TO CANDIDATES

1. Write your name, index number and class in the space above.
2. Do not turn over this page until you are told to do so.
3. Follow all instructions carefully.
4. Answer all questions.
5. For Section A, shade your answers for questions 1 to 10 in the Optical Answer Sheet (OAS) provided.
6. For Section B, write your answers for questions 11 to 18 in the space provided in the booklet.
7. The total marks for Booklet A is 20 marks.

Section A (20 marks)

For each question 1 to 10, four options are given. One of them is the correct answer. Make your choice (1, 2, 3 or 4). Shade the oval (1, 2, 3 or 4) on the Optical Answer Sheet.

1. The diagram below shows Circuit A, B, C and D with different arrangements of identical batteries and bulbs. All the bulbs lighted up.

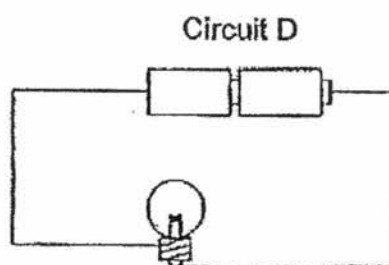
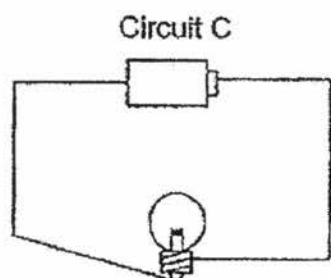
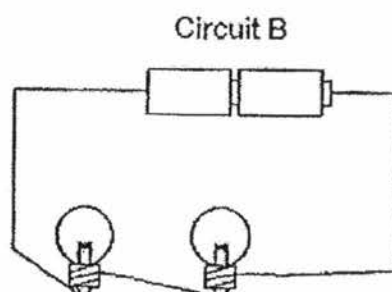
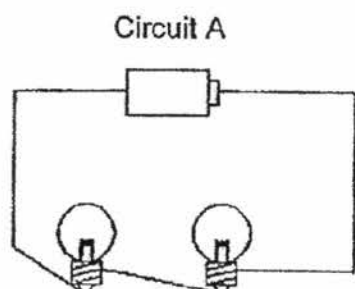

Which one of the following shows the degree of brightness of the bulbs in the circuits?

	Bright	Brighter	Brightest
(1)	A	B	C
(2)	C	D	B
(3)	A	C	D
(4)	B	C	A

()

2. Peter set up the circuit shown below.

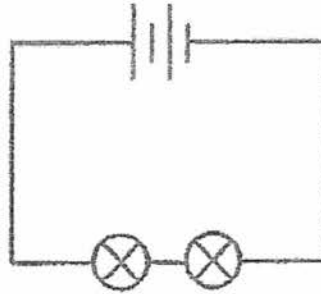

Which of the following would decrease the brightness of the bulbs?

- A: Arrange the bulbs in parallel
- B: Decrease the number of batteries used
- C: Add one more bulb in series with the other bulbs
- D: Add one more battery in series with the other batteries

- (1) A and B only
- (2) B and C only
- (3) C and D only
- (4) A, C and D only

()

3. Sarah tested the switches in an electrical circuit and obtained the results as shown below.

Switch Y	Switch Z	Number of bulbs lighted
Open	Open	0
Closed	Open	2
Open	Closed	2
Closed	Closed	2

Which one of the circuits below did Sarah use?

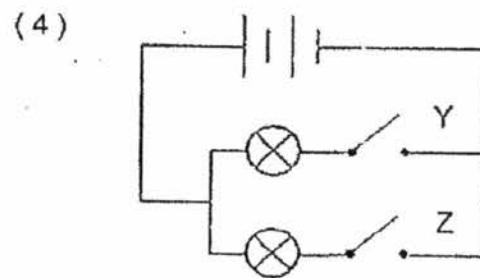
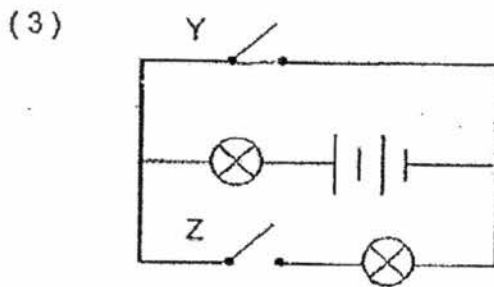
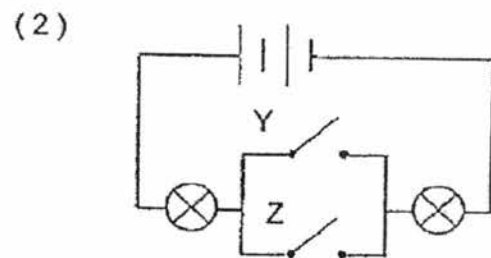
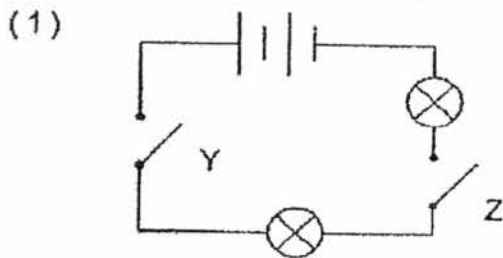

()

4. The circuit card shown below has a metal clip at points W, X, Y and Z. Some of the clips are connected by wires behind the card.

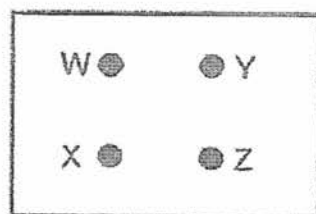

Circuit card

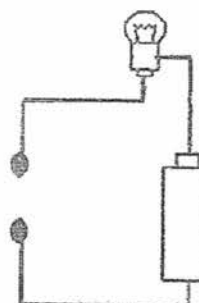

Circuit tester

A circuit tester above is used to test the circuit cards.

The results are recorded in the table below.

Circuit tester connected to clips at:	Does the bulb light up?
W and Z	Yes
W and X	Yes
Y and Z	No

Which one of the following circuit cards shows the correct connections of the wires?

(1)

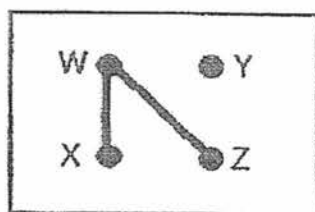

(2)

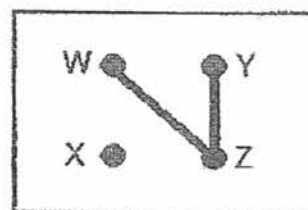

(3)

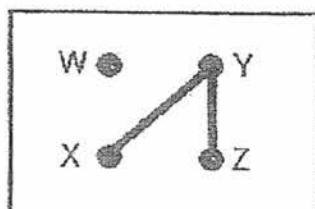

(4)

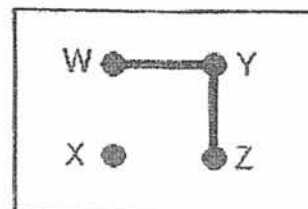

()

5. Alan used the circuit below to test on three objects, P, Q and R as shown in the diagram. The three objects were made from different materials.

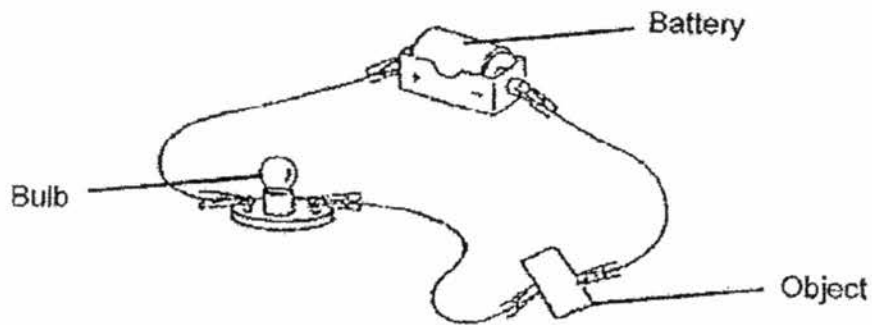

The results of the test were as follows:

Object	Did the bulb light up?
P	No
Q	Yes
R	Yes

Which one of the following shows the likely materials that the objects P, Q and R were made from?

	P	Q	R
(1)	Paper	Glass	Plastic
(2)	Aluminium	Steel	Rubber
(3)	Rubber	Copper	Aluminium
(4)	Gold	Iron	Steel

()

6. The diagram below represents the water cycle.

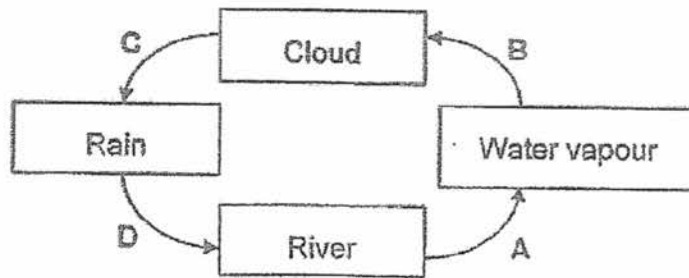

Which one of the following is correct?

	Condensation occurred at	Evaporation occurred at
(1)	A	B
(2)	B	C
(3)	D	C
(4)	B	A

()

7. Ahmad travelled to school by an air-conditioned bus. He observed that the windows looked different during different times of the day. He recorded his observations below.

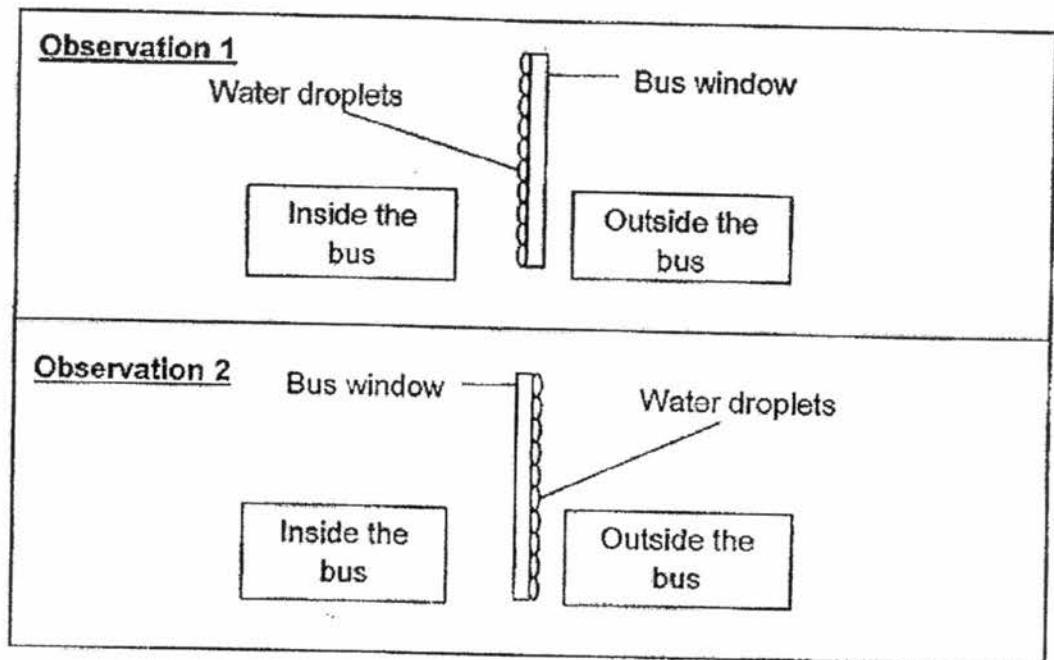

He then made four statements based on his observations.

- A. In Observation 1, the temperature outside the bus was the same as the temperature inside the bus.
- B. In Observation 1, water droplets are formed when the water vapour inside the bus condenses on the window.
- C. In Observation 2, the temperature outside the bus was higher than the temperature inside the bus.
- D. In Observation 2, water droplets are formed when the water vapour outside the bus condenses on the window.

Which of the following statements about Ahmad's observations are correct?

- (1) A and B
- (2) C and D
- (3) A, B and C
- (4) B, C and D

()

8. The diagram below shows the different states of water and the different processes it goes through.

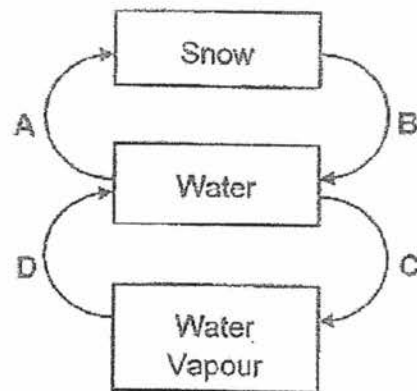

Which of the following correctly identifies the transfer of heat at A, B, C and D?

Process	Transfer of heat
A	heat loss
B	heat loss
C	heat loss
D	heat gain

- (1) A
- (2) B
- (3) C
- (4) D

()

9. Caden's mum poured hot tea for him while they were having breakfast.

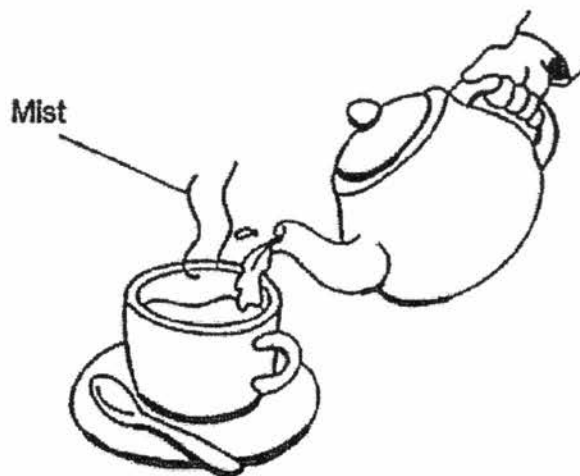

When the tea flowed into the cup, Caden noticed 'mist' along the trail of tea.

Which of the following statement(s) about the 'mist' is/are correct?

- A: The 'mist' is in the same state as rain.
- B: The 'mist' is in the same state as steam.
- C: The 'mist' condense to form water droplets.
- D: The 'mist' evaporate to form water vapour.

- (1) B only
- (2) A and D
- (3) B and C
- (4) C and D

()

10. The water cycle is a natural way of _____.

- (1) reducing flooding
- (2) reducing water wastage
- (3) making us use water wisely
- (4) making water reusable again

()

~End of Booklet A~

RIVER VALLEY PRIMARY SCHOOL
CONTINUAL ASSESSMENT 2 / 2017
PRIMARY 5

STANDARD SCIENCE

(BOOKLET B)

Name : _____ ()

Date : 16 Aug 2017

Class : P5 _____

Total Time for Booklet A & Booklet B : 1 hour

INSTRUCTIONS TO CANDIDATES

1. Write your name, index number and class in the space above.
2. Do not turn over this page until you are told to do so.
3. Follow all instructions carefully.
4. Answer all questions.
5. For Section A, shade your answers for questions 1 to 10 in the Optical Answer Sheet (OAS) provided.
6. For Section B, write your answers for questions 11 to 18 in the space provided in the booklet.
7. The total marks for Booklet B is 30 marks.

Booklet A		/20
Booklet B		/30
Total		/50
Parent's Signature		

Section B (30 marks)

Write your answers to questions 11 to 18 in this booklet.

11. Adam wears a pair of goggles when he goes swimming.

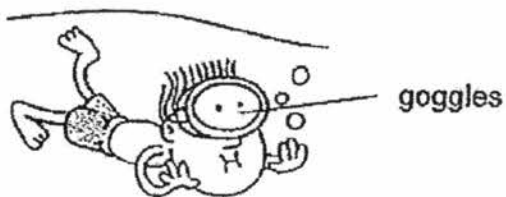

He notices that as he swims, tiny water droplets start to form on the insides of his goggle lens.

- (a) Explain how the tiny water droplets formed on the inside of his goggle lens. [1m]

Adam went for a swim at two different times; 12 noon and 7 pm. He noticed that the water droplets inside his goggle lens formed fastest at one of the times.

- (b) At which time did the water droplets form the fastest? Explain your answer. [2m]

- (c) When Adam came out of the pool, he felt cold. Explain why he felt cold. [1m]

	4
--	---

12. Bala placed three different containers, A, B and C, in an open field. Each container contains the same volume of water.

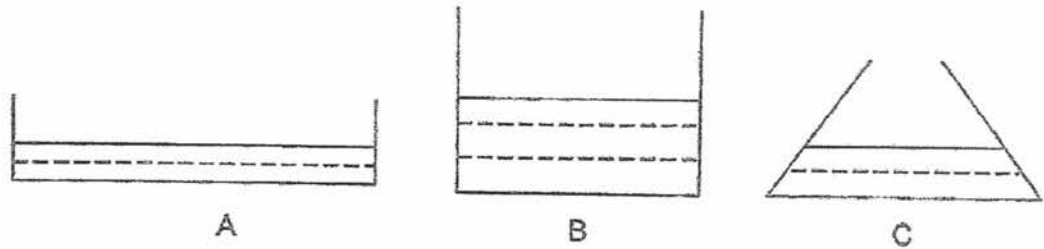

After some time, he measured the volume of water in each container and drew line graphs for each container.

- (a) The aim of Bala's experiment is to find out if the amount of _____ affects how much water evaporates. [1m]
- (b) Bala drew a line graph for container B shown below. Draw and label the line graph for container A and container C below. [2m]

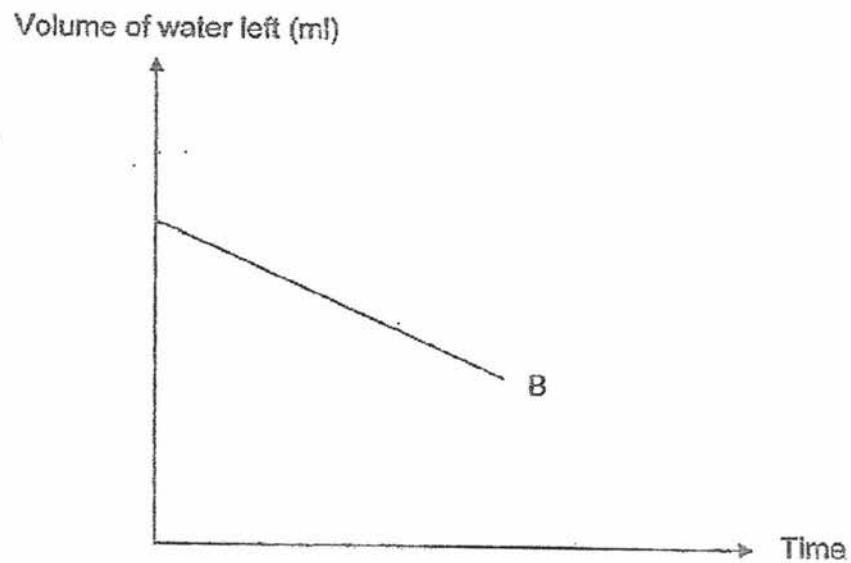

	3
--	---

13. Lucy placed a beaker of water over a heater and covered it with a metal plate as shown in the diagram below.

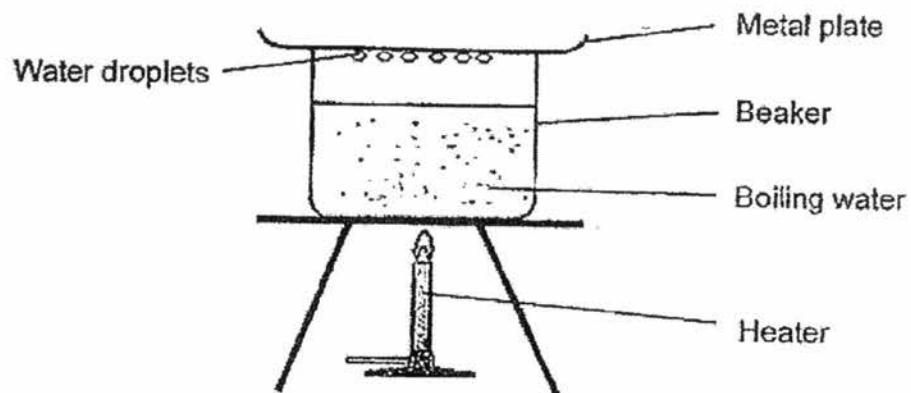

After some time, she noticed that water droplets had formed on the bottom of the metal plate and fallen back into the water.

- (a) What would she observe about the water droplets if she put ice cubes in the metal plate? [1m]

Lucy then replaced the metal plate with a wooden board. She observed that the amount of water droplets had decreased.

- (b) Explain her observation. [2m]

	3
--	---

14. Weili was given the following items by her Science teacher. She had to make use of all the items given to set up a circuit such that when one bulb fused, the other bulbs will not light up.

- 3 bulbs
- 2 batteries
- 1 switch
- some electric wires

(a) Draw a circuit diagram in the box provided below to show the possible electric circuit that Weili had set up. [2m]

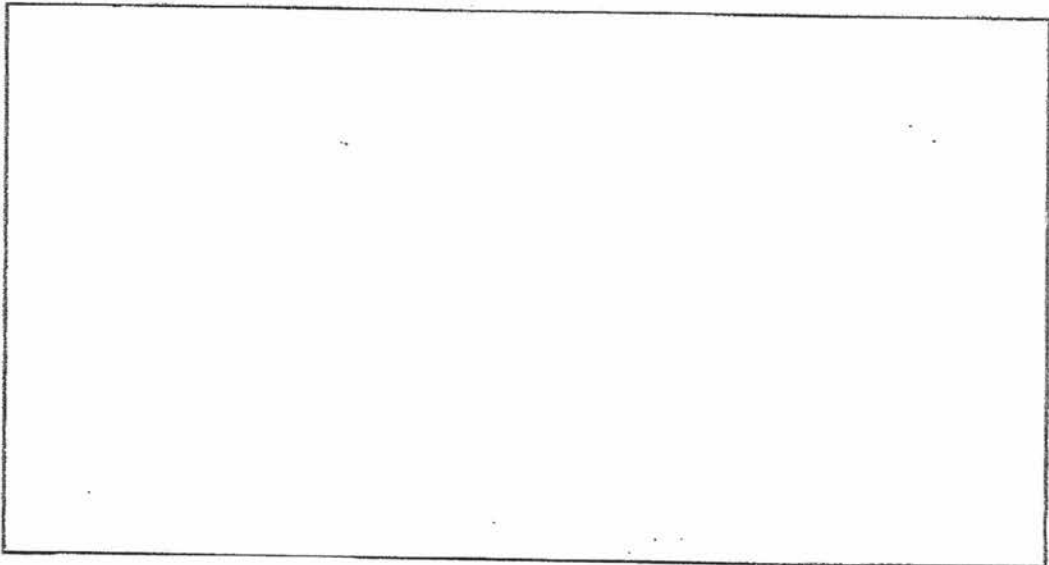

(b) Weili noticed that the wires she used in the experiment is covered with an outer layer of plastic. Explain the function of the layer of plastic. [1m]

(c) Other than plastic, what other material can be used to cover the wires? [1m]

	4
--	---

15. The diagram below shows a tunnel and the circuit on a toy train set up by Mary. The bulb only lights up when the whole train entered the tunnel fully.

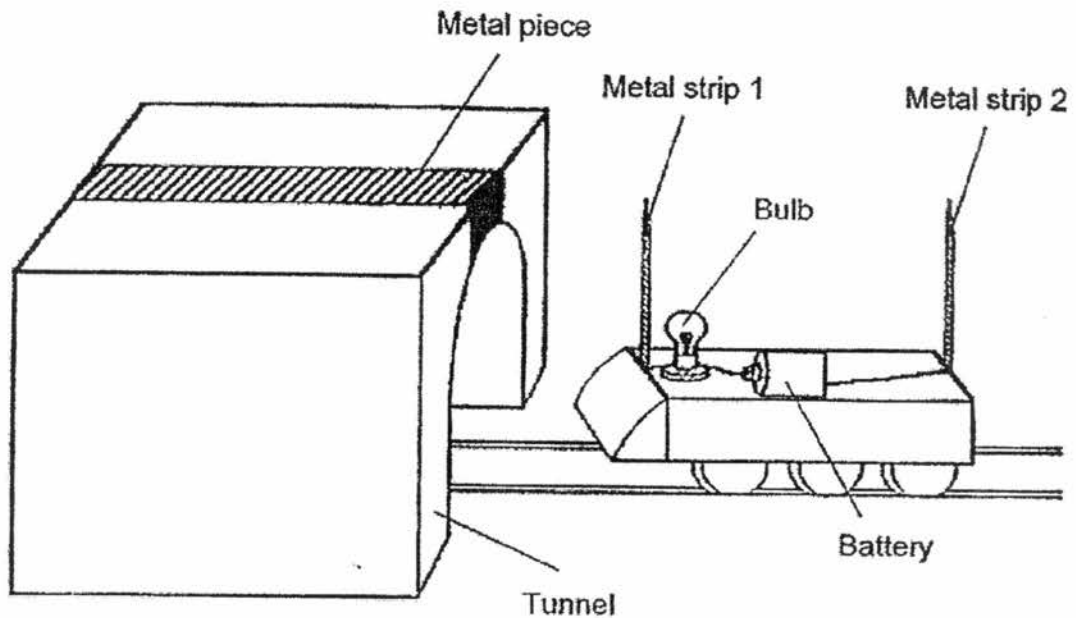

- (a) Explain why the bulb would not light up if only part of the train enters the tunnel. [2m]

Mary added three new batteries in series. The bulb lit up very brightly the first time the train entered the tunnel. However, when the train entered the tunnel again, the bulb did not light up.

- (b) Suggest two possible reasons why the bulb did not light up. [2m]

(i) _____

(ii) _____

	4
--	---

16. The diagrams below show the electrical circuit for light bulbs in Tom's house and Kevin's house.

Tom's house

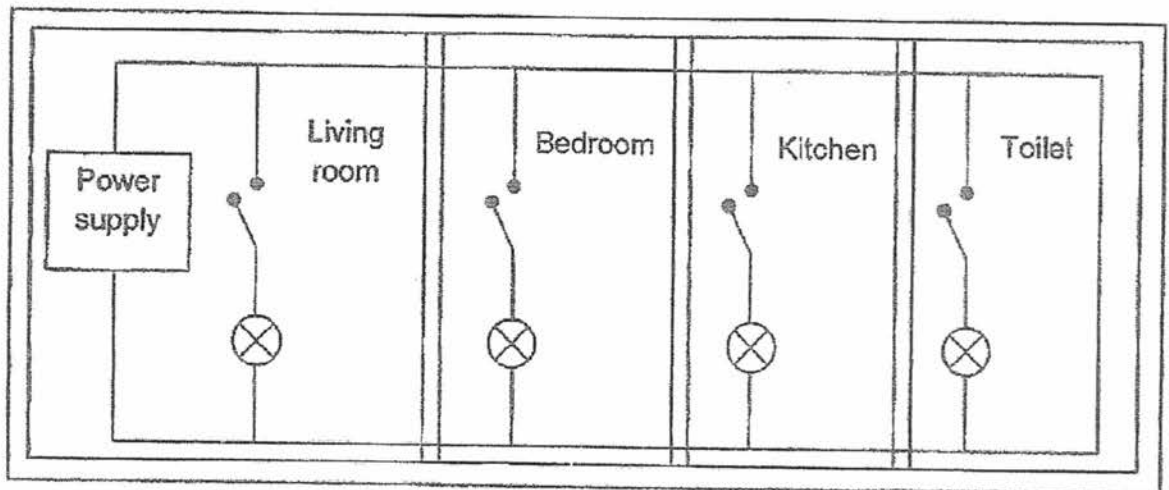

Kevin's house

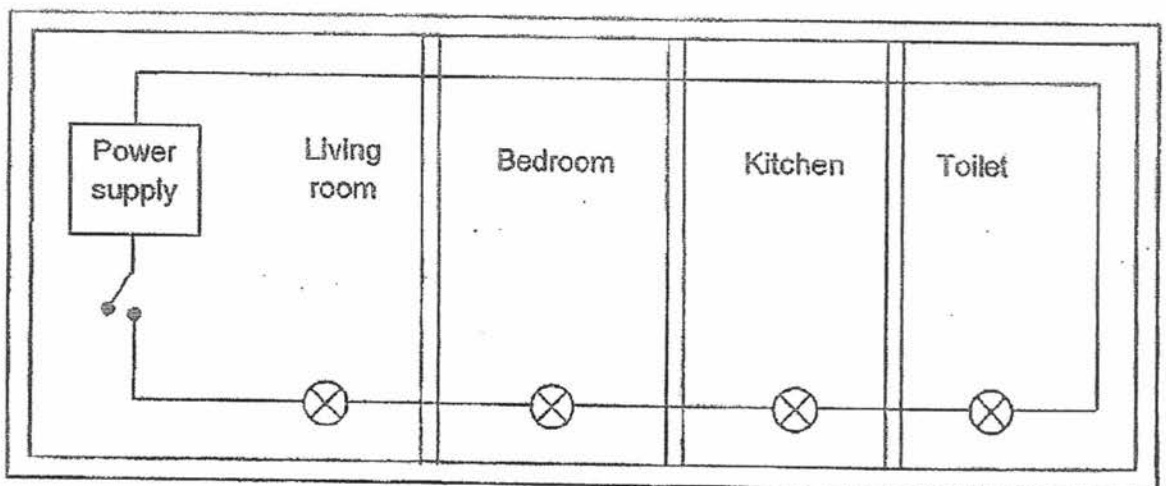

Key:  Wall

(a) Write one advantage of Kevin's electrical circuit compared to Tom's. [1m]

(b) Write one advantage of Tom's electrical circuit compared to Kevin's. [1m]

(c) If the power supply to Tom's and Kevin's houses are the same and both of them are using the same light bulbs, whose house would have brighter bulbs? [1m]

(d) Suggest two ways to conserve electricity. [1m]

(i)

(ii)

	4
--	---

17. Study the circuit below.

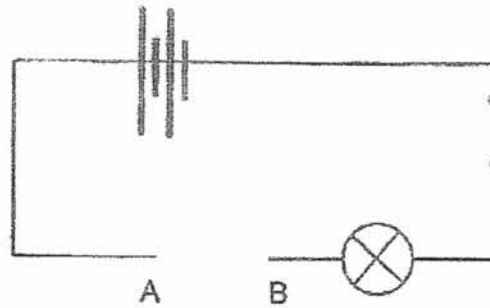

Ramu connected wires of different thickness to points A and B above. Each time the bulb lit up, the brightness was compared using a scale of 1 to 4, with 1 being the least bright and 4 being the brightest. The data collected is shown in the table below.

Thickness of wire	Brightness of bulb
1 mm	1
2 mm	2
3 mm	3
4 mm	4

- (a) What is the relationship between the thickness of the wire and the brightness of the bulb? [1m]

- (b) If Ramu replaced the wire at points AB with a pencil lead, what would he observe? [1m]

- (c) Explain your answer in (b). [2m]

	4
--	---

18. Karen set up the circuit below. She observed that one of the bulbs did not light up.

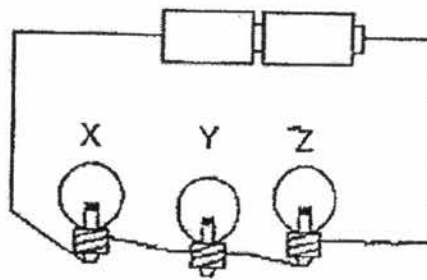

- (a) Which bulb did not light up? [1m]

Bulb _____

- (b) Give a reason why the bulb mentioned in (a) did not light up. [1m]

- (c) Complete the circuit below such that all three bulbs will light up. [2m]

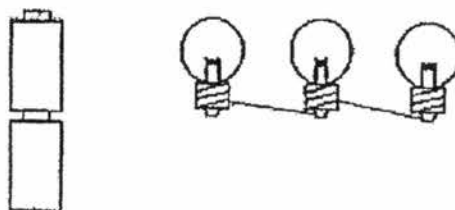

	4
--	---

~End of Paper~

SCHOOL : RIVER VALLEY PRIMARY SCHOOL
 LEVEL : PRIMARY 5
 SUBJECT : SCIENCE
 TERM : 2017 CA2

SECTION A

Q 1	Q2	Q3	Q4	Q5	Q6	Q7	Q8	Q9	Q10
3	2	2	1	3	4	4	1	3	4

SECTION B

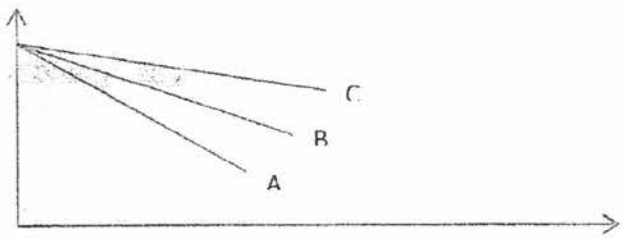
Q11)	<p>(a) The water in the swimming pool is cold. The cold surface of the goggles comes into contact with the warmer water vapour in the goggles and condenses into tiny water droplets.</p> <p>(b) 7pm. At night, the surrounding air is colder, causing the water to be affected. The much cooler surface of the goggles will come into contact with the warm water vapour in the goggles and condense into tiny water droplets faster.</p> <p>(c) The water on his body absorbed heat from his body to evaporate, making him feel cold.</p>
Q12)	<p>(a) exposed surface area</p> <p>(b)</p> 
Q13)	<p>(a) More water droplets will form on the bottom of the metal plate.</p> <p>(b) The wooden board was not as cold as the metal plate, causing the rate of evaporation to be slower on the wooden board than the metal plate.</p>

Q14)

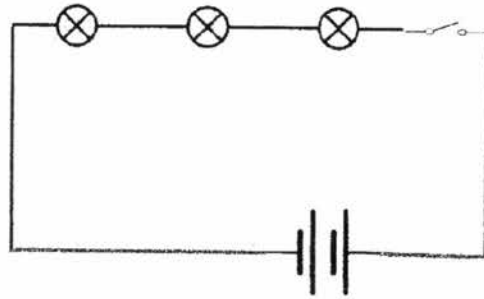

- (b) As plastic is a poor conductor of electricity, Weili will not be electrocuted.
- (c) Rubber

Q15)

- (a) If only half of the train enters the tunnel, only metal strip 1 will touch the metal piece and will form an open circuit.
- (b) (i) The bulb had fused
(ii) The batteries are flat

Q16)

- (a) Kevin's electrical circuit uses less electricity compared to Tom's.
- (b) Tom's electrical circuit saves more electricity than Kevin's electrical circuit
- (c) Tom
- (d) (i) Switch off the lights when not in use
(ii) Switch off any appliances which are not in use

Q17)

- (a) The thicker the wire, the brighter the bulb.
- (b) The bulb will still light up.
- (c) Pencil lead is a good conductor of electricity.

Q18)

- (a) Bulb Y
- (b) The wires were only connected to the metal casing and not the metal tip for bulb Y.

(c)

