



NAN HUA PRIMARY SCHOOL
CONTINUAL ASSESSMENT 1 2017
PRIMARY FIVE
SCIENCE

Name : _____ ()

Class : Primary 5 / _____

Date : 24 February 2017

MARKS	
Sect A:	/ 56
Sect B:	/ 44
Total :	/ 100

Parent's Signature

Section A: (28 x 2 marks = 56 marks)

For each question from 1 to 28, four options are given. One of them is the correct answer. Make your choice (1, 2, 3 or 4). Shade the correct oval (1, 2, 3 or 4) on the Optical Answer Sheet.

- 1 The diagram below shows how an organ can be formed from a basic unit of life represented by W.

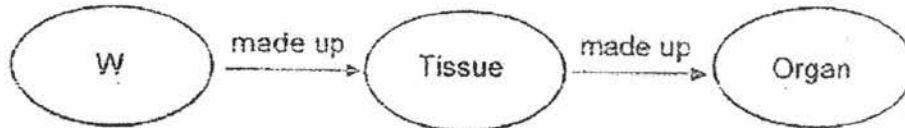

Which of the following correctly represents the basic unit of life?

- (1) Cell
- (2) Cell wall
- (3) Cytoplasm
- (4) Cell membrane

2. A cell and a plant are shown in the diagrams below.

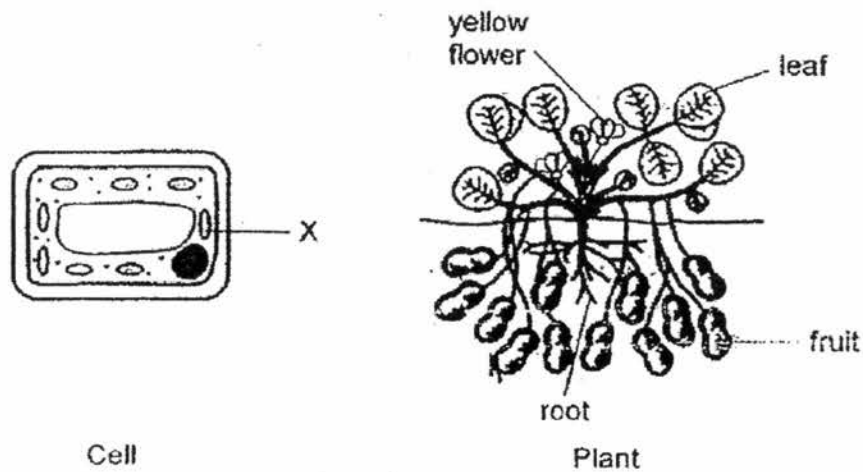

Which part of the plant can part X be found?

- (1) fruit
- (2) leaf
- (3) root
- (4) yellow flower

3. The diagram below shows a group of cells.

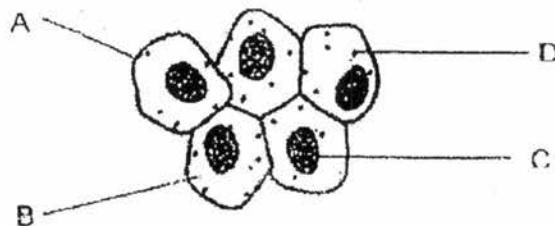

Which part of the cell contains genetic information that is passed on from one generation to the next?

- (1) A
- (2) B
- (3) C
- (4) D

4. The diagram below shows the physical characteristics of two parent plants and their offsprings.

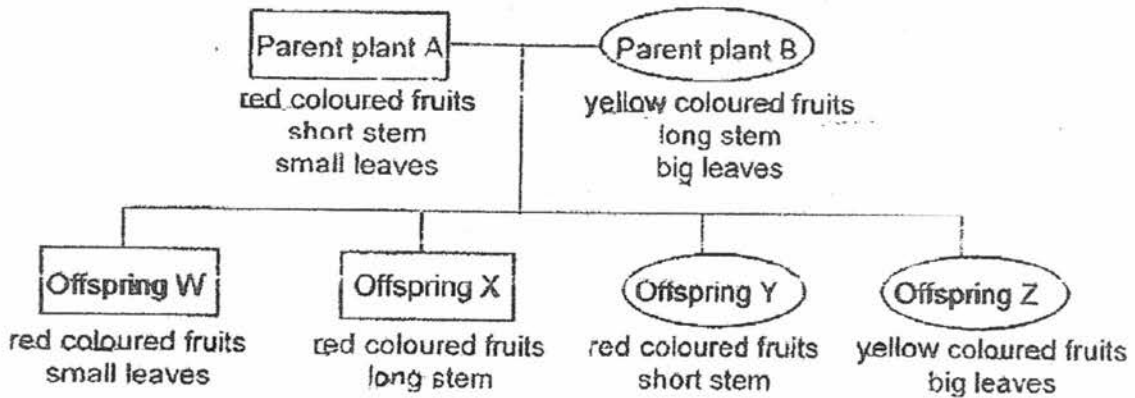

Which offspring inherited only one characteristic from each parent?

- (1) Offspring W
 - (2) Offspring X
 - (3) Offspring Y
 - (4) Offspring Z
5. The diagram below shows a plant.

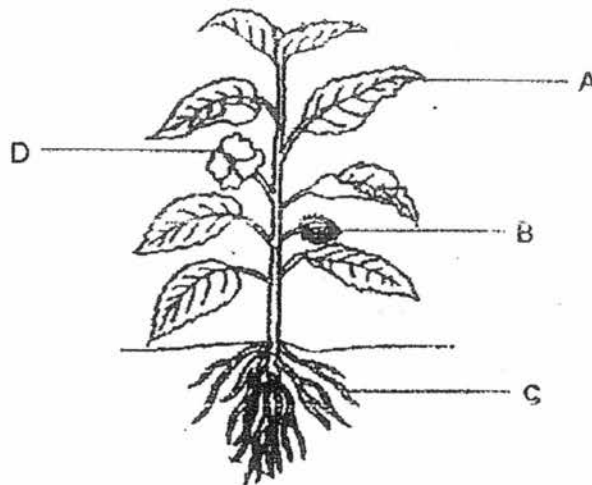

Which reproductive part(s) help(s) the plant to reproduce?

- (1) B only
- (2) A and C only
- (3) B and D only
- (4) A, B and C only

6. The diagram below shows the development of seeds to seedlings.

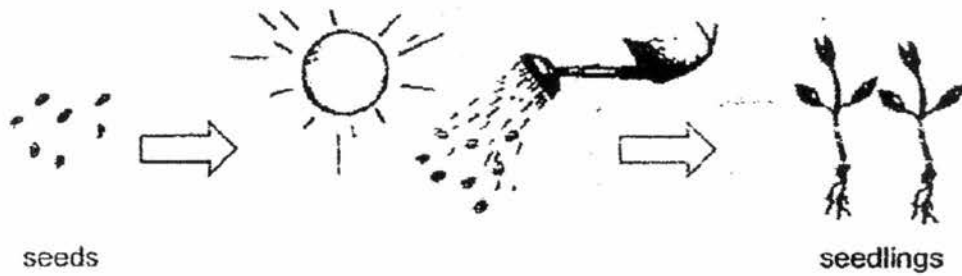

Which of the following are needed by the seeds to develop into seedlings?

- A soil
 - B water
 - C oxygen
 - D warmth
- (1) A and D only
(2) B and C only
(3) B, C and D only
(4) A, B, C and D
7. The Jay bird collects nuts and buries them in the ground to eat later. Sometimes, the Jay bird does not go back for the nuts.

What will most likely happen to the buried nuts?

- (1) The buried nuts will be fertilised
- (2) The buried nuts will be pollinated.
- (3) The buried nuts will develop new fruit.
- (4) The buried nuts will develop into seedlings.

8. The diagram below shows a fern growing on a tree.

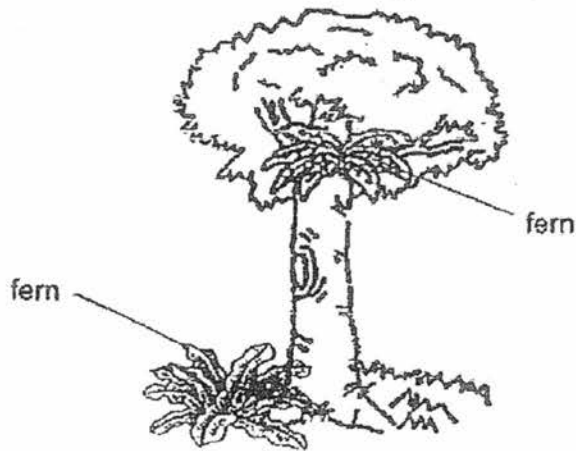

How did the fern grow on the tree?

- (1) The wind carried the fern to the tree.
 - (2) The insects carried the spores to the tree.
 - (3) The wind carried the seeds from the fern to the tree.
 - (4) The wind carried the spores from the fern to the tree.
9. The diagram below shows the changes in the state of water.

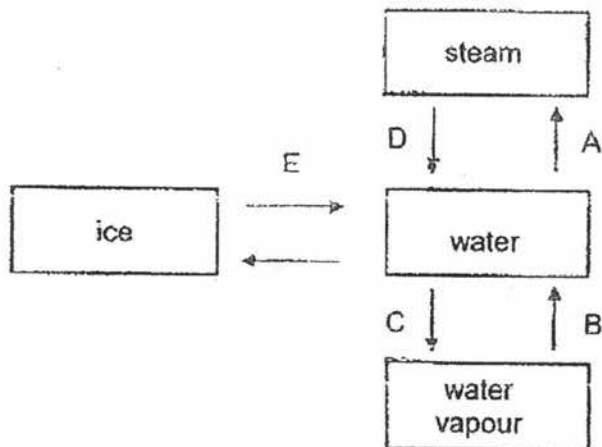

Which of the following processes, A, B, C, D, E or F, will heat loss take place?

- (1) A, C and E only
- (2) B, D and F only
- (3) A, B, D and F only
- (4) B, C, E and F only

10. Which activities are a good way of saving water?

- A Take a shower instead of a bath
- B Put bigger and more pebbles into fish tank.
- C Collect water from washing vegetables to flush the toilet.
- D Use water hose to wash car instead of using a pail of water.

- (1) A and D only
- (2) B and D only
- (3) A, B and C only
- (4) A, B, C and D

11. The diagram below shows two beakers, with the same amount of water at different temperature, placed in the same room.

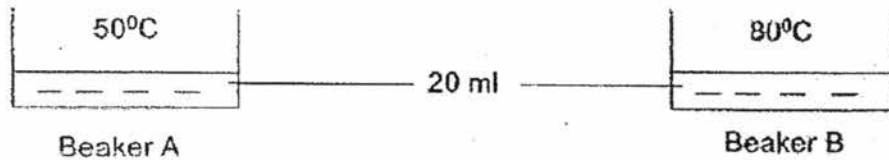

Which one of the following statements is correct?

- (1) Both beakers of water will reach room temperature at the same time.
- (2) The amount of heat in the water in beaker A and beaker B is the same.
- (3) The amount of heat in the water in beaker A is greater than in beaker B.
- (4) The amount of heat in the water in beaker B is greater than in beaker A.

12. Study the graphs below. Graph A shows the relationship between the number of substance X and light intensity. Graph B shows the relationship between the number of substance X and the mass of plant.

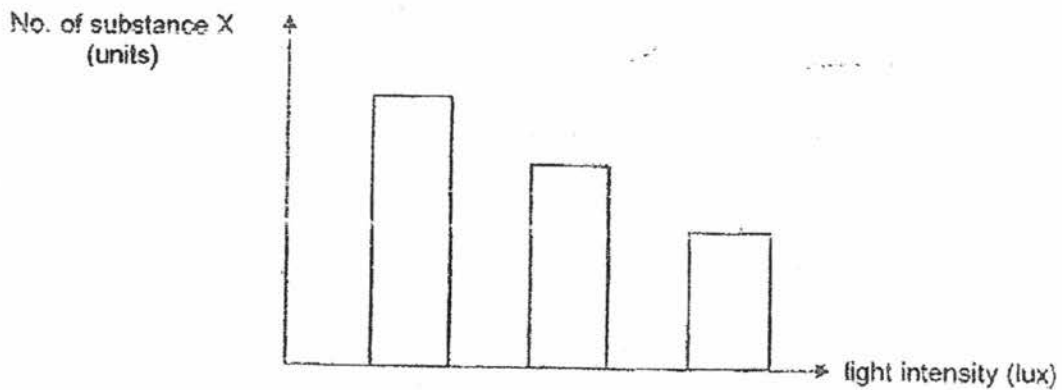

Graph A

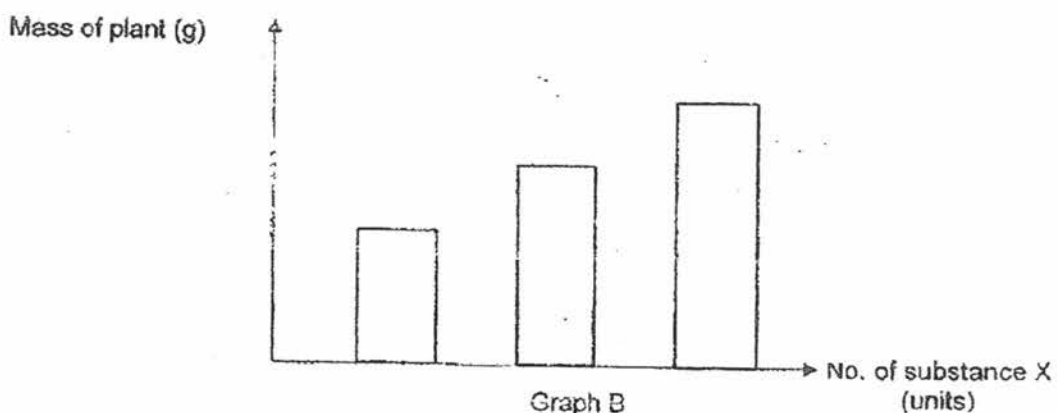

Graph B

Based on the graphs, which of the following statements is/are correct?

- A Strong light intensities can reduce the number of substance X.
- B The mass of the plant will decrease when the light intensity decrease
- C As the number of substance X increases, the mass of the plant increases.

- (1) A only
- (2) A and C only
- (3) B and C only
- (4) A, B and C

13. Which one of the following shows the correct comparison between a plant cell and an animal cell?

	Animal cell	Plant cell
(1)	It has more than one nucleus	It has one nucleus
(2)	It does not have chloroplast	It has chloroplast
(3)	It has a cell wall but cannot maintain a regular shape	It has a cell wall to maintain a regular shape
(4)	It has cytoplasm that is surrounded by cell membrane	It has cytoplasm that is surrounded by cell wall

14. The diagram below shows the pattern of seed dispersal of four types of trees.

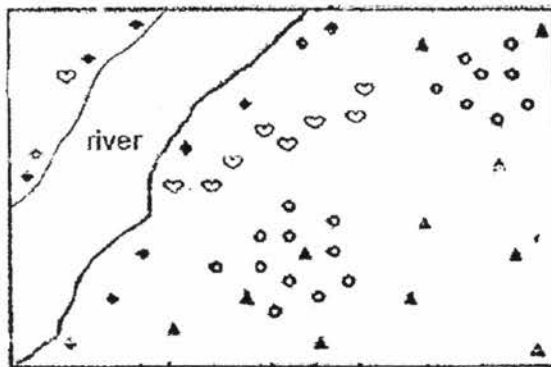

Key	
Tree A -	♡
Tree B -	◆
Tree C -	▲
Tree D -	○

The diagram below shows the fruit of one of the trees.

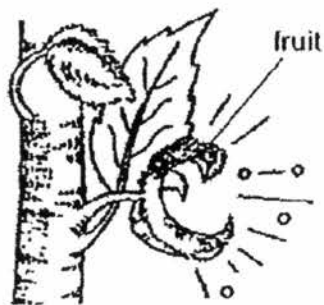

Based on the diagrams, which symbol represents the tree of the fruit shown above?

- (1) ♡
 (2) ◆
 (3) ▲
 (4) ○

15. An experiment is set up to find out how different types of liquid will affect the germination of seeds from the same plant.

The diagram below shows the set-ups of the experiment.

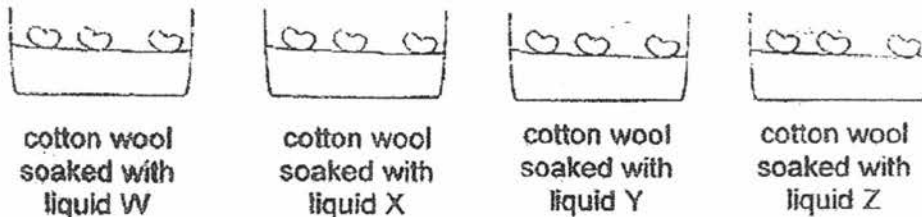

Which of the statement(s) correctly explain(s) why there must be more than one seed in each set-up?

- A To grow more plants for the experiment.
- B To absorb the liquid faster so that the seeds germinate faster.
- C To ensure that there are still seeds left to carry out the experiment even if some died.

- (1) C only
- (2) A and B only
- (3) B and C only
- (4) A, B and C

16. The table below describes the appearance of flowers from three different types of plants.

Flower	Brightly coloured petals	Gives off a sweet scent	Anthers and stigma stick out of the flower
X	No	Yes	No
Y	No	No	Yes
Z	Yes	No	No

Based on the information in the table, which of the flowers is/are most likely pollinated by insects?

- (1) Z only
- (2) X and Y only
- (3) X and Z only
- (4) X, Y and Z

17. The diagram below shows the young of an organism during one of the stages in its life cycle.

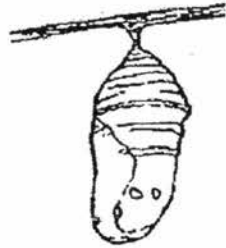

Which one of the following will the young above look like when it becomes an adult?

(1)



caterpillar

(2)

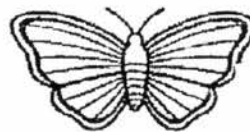

butterfly

(3)



mosquito

(4)



cockroach

18. An experiment was conducted and the graph below shows the temperature change of some ice cubes.

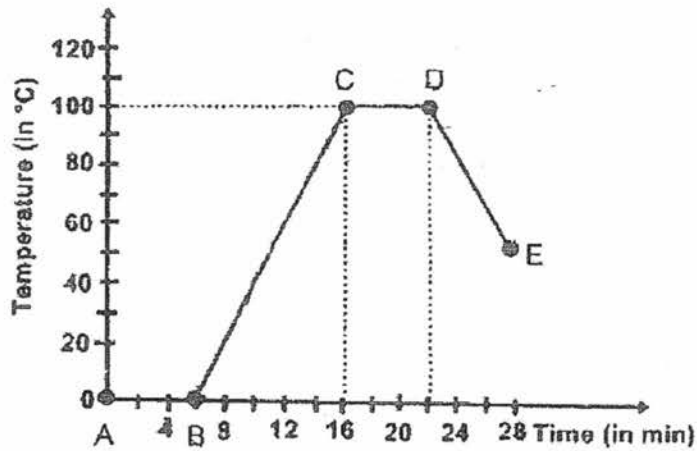

Based on the graph, which of the following statements is/are correct?

- A The water lost heat from part D to E.
- B There was a change of state from part A to B and part C to D only.
- C There was no heat gain from part A to B, but there was heat gain from part B to C.

- (1) A only
- (2) A and C only
- (3) B and C only
- (4) A, B, and C

19. The diagram below shows a distiller.

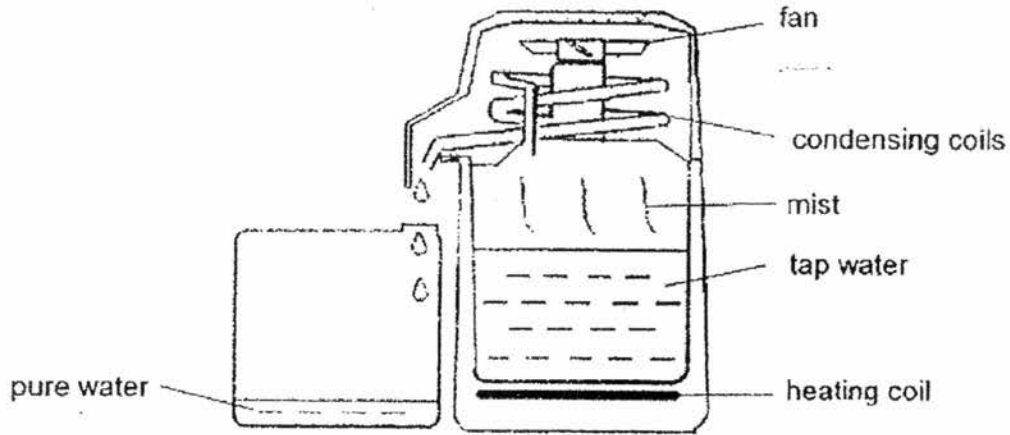

A distiller is used to separate substances found in tap water so as to get pure water for drinking. First, the tap water has to be heated by the heating coil.

Which one of the following statements shows the correct functions of the different parts of the distiller?

	Heating coil	Condensing coils	Fan
(1)	To boil the water to get water vapour	To provide a cool surface for the water vapour	To heat up the condensing coils
(2)	To boil the water to get water vapour	To provide a warm surface for the water vapour	To cool the condensing coils
(3)	To boil the water to get steam	To provide a warm surface for the steam	To heat up the condensing coils
(4)	To boil the steam to get steam	To provide a cool surface for the steam	To cool the condensing coils

20. Sam used the following set-up to find the volume of the ball.

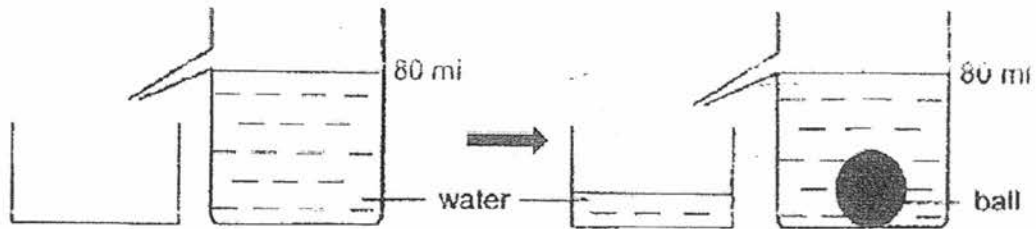

What property/ properties of water enable(s) him to find the volume of the ball?

- A Water has a definite mass
- B Water has a definite shape.
- C Water has a definite volume.

- (1) B only
- (2) C only
- (3) A and C only
- (4) A, B and C

21. The diagram below shows that some identical wooden blocks were being put into a tray.

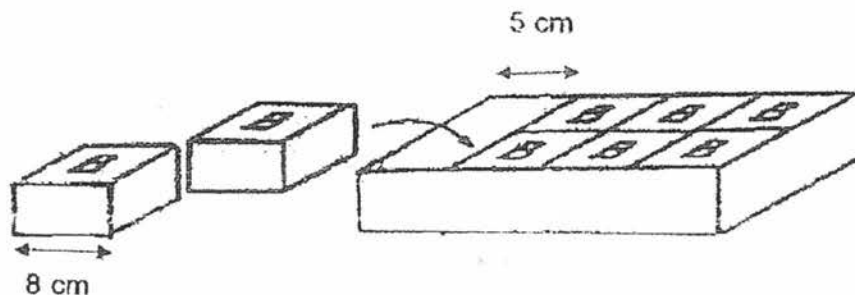

Which of the following statements correctly explain(s) why the remaining two wooden blocks were unable to fit into the tray?

- A The blocks have fixed shape.
- B The blocks have fixed volume.
- C The blocks cannot be compressed.

- (1) A only
- (2) A and B only
- (3) B and C only
- (4) A, B and C

22. The diagrams below show different set-ups.

A

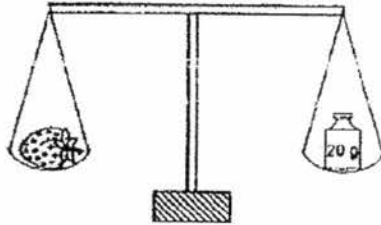

B

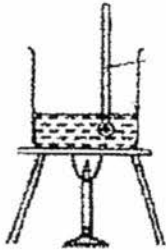

C

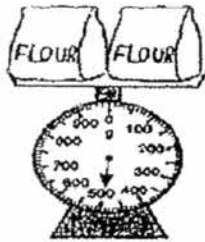

Which of the set-up(s) can be used to measure mass?

- (1) B only
- (2) C only
- (3) A and B only
- (4) A and C only

23. Study the diagram below.

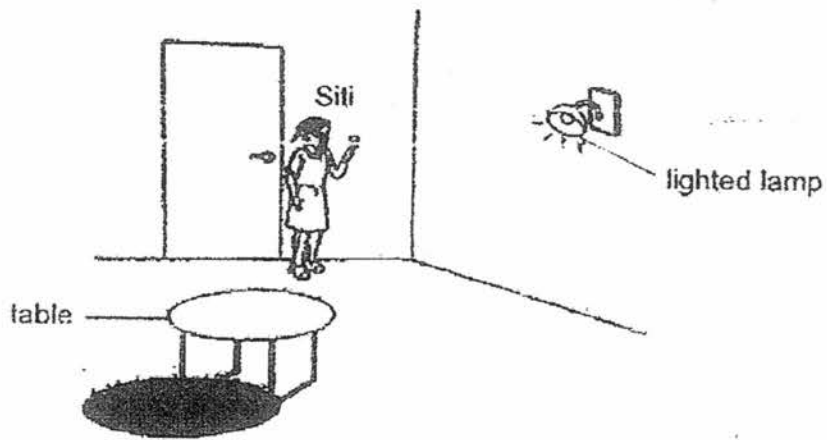

Which one of the following statements correctly explains why Siti was able to see the table in the room?

- (1) Light from the lamp falls onto the table.
- (2) Light from the lamp shines into Siti's eyes.
- (3) Light from the lamp was reflected from the table to Siti's eyes.
- (4) Light from the lamp was reflected from Siti's eyes onto the table.

24. The diagram below shows a torch shining on a circular metal disc.

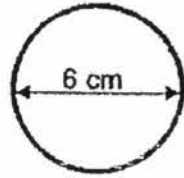

circular metal disc

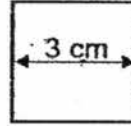

square screen

The circular disc and the square screen are hung from a board to suspend them in the air.

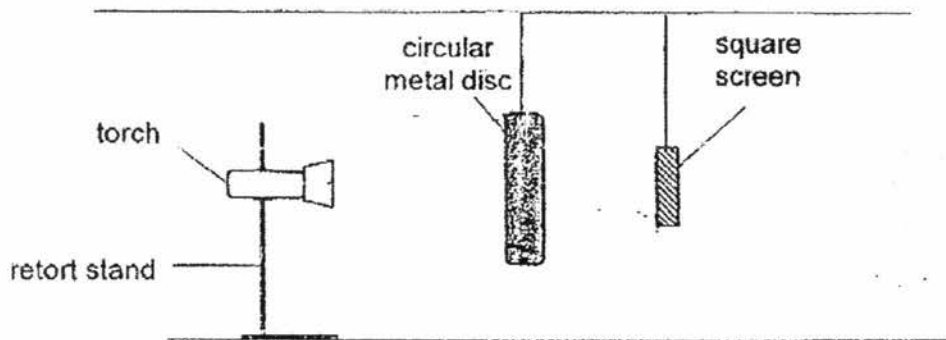

Which one of the following shadows will be shown on the screen?

(1)



(2)



(3)



(4)



25. An experiment was conducted to find out how the size of the shadow is affected by the distance between the object and the screen.

The diagram below shows the set-up of the experiment.

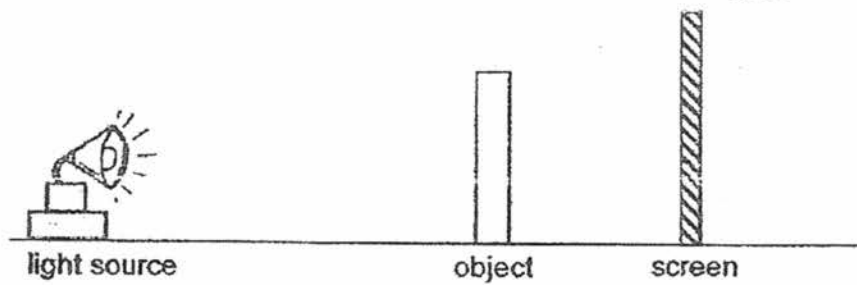

How should the experiment be carried out in order to collect data?

- (1) To use glass for the screen.
- (2) To move the screen away from the object.
- (3) To move the light source nearer to the object.
- (4) To exchange the positions of the screen and the object.

26. An experiment is set up as shown below.

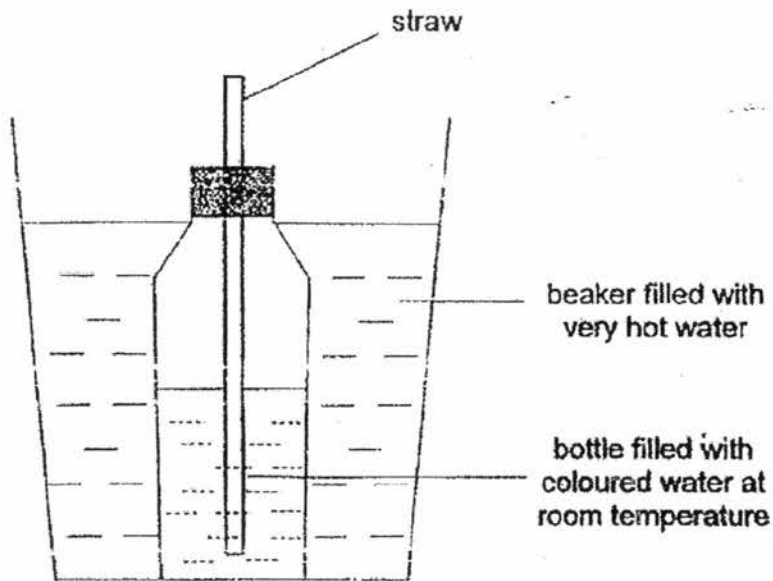

When the bottle was put into the beaker of hot water, water started sprouting out of the straw. After a while, the water stopped sprouting out.

Which one of the following statements correctly explains why the water eventually stopped sprouting out from the straw?

- (1) All the water in the beaker had sprouted out of the straw.
- (2) The water in the bottle became colder than the water in the beaker.
- (3) All the water in the beaker evaporated immediately after the bottle was put in.
- (4) The water inside the beaker has reached the same temperature as the water in the bottle.

27. Four different metals, S, T, U and V, are used to make five rings as shown below. The dimension of the three big rings are the same. The dimension of the two small rings are identical to each other.

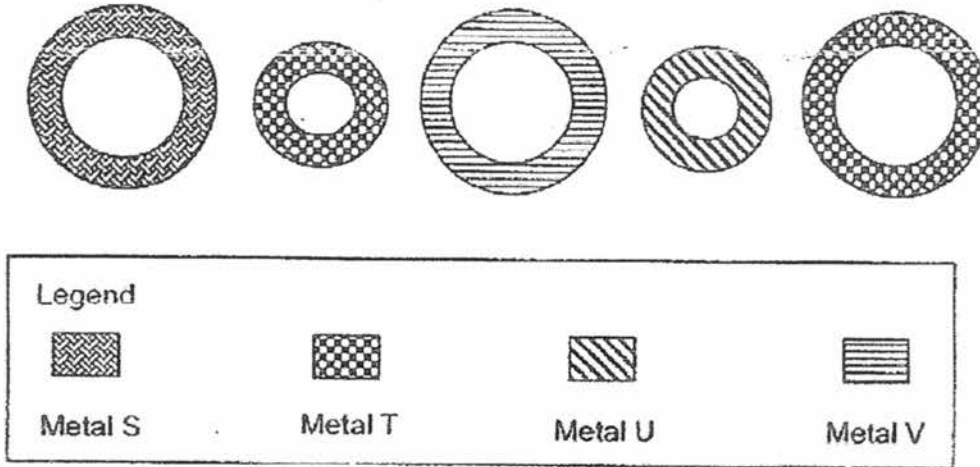

The five rings are fitted together to make three sets of ring, A, B and C.

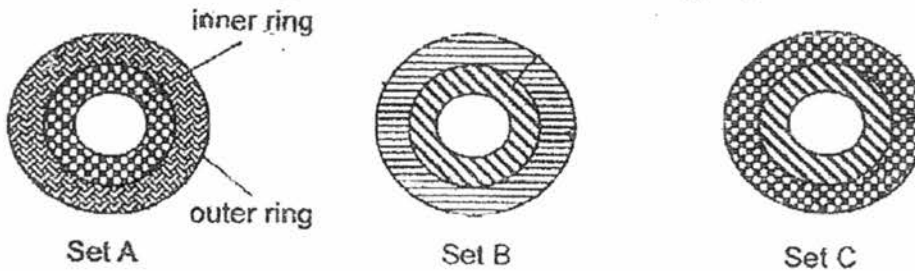

At 28°C, the inner rings of each set could just fit into the outer ring and taken out with some effort. The sets of rings were heated to 40°C. The observations were recorded in the table below.

At 40°C		
Set A	Set B	Set C
Inner ring fell out of outer ring easily.	Inner ring could not be pulled out of outer ring even with great effort	Inner ring could just fit into outer ring and still pull out with some effort

Based on the above observations, which metal, S, T, U or V, expanded the most?

- (1) S
- (2) T
- (3) U
- (4) V

28. Two containers, one made of copper and the other of glass, were filled with the same amount of water. A glass tubing was then inserted into each container and the level of water in each tubing was adjusted to the same level as shown in the diagram below. The containers were then heated.

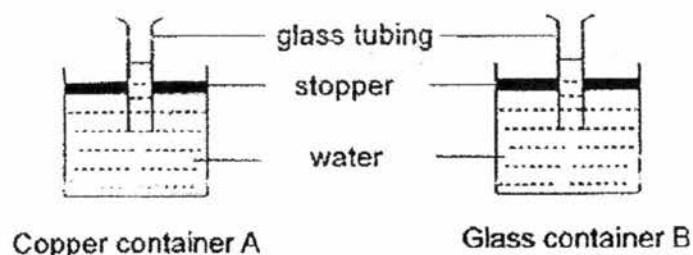

In which glass tubing will the water level rise first?

	Glass tubing in Container	Explanation
(1)	A	Copper is a better conductor of heat. The container expand faster upon heating causing the water level to rise faster.
(2)	A	Copper is a better conductor of heat and conduct heat faster to the water, causing water level to rise faster.
(3)	B	Glass is a poorer conductor of heat. The glass container contracted upon heating causing the water level to rise faster.
(4)	B	Glass is a poorer conductor of heat, causing the water in the container to absorb heat faster than the glass. so water level rises faster.



NAN HUA PRIMARY SCHOOL
CONTINUAL ASSESSMENT 1 2017
PRIMARY FIVE
SCIENCE

MARKS
44

Name : _____ ()

Class : Primary 5 / _____

Section B: (44 marks)

Write your answers to questions 29 to 40.

The number of marks available is shown in brackets [] at the end of each question or part question.

29. The diagram below shows two similar set-ups of an experiment used to show the function of a specific cell part. The mass of the container without the funnel in each set-up is 750 g.

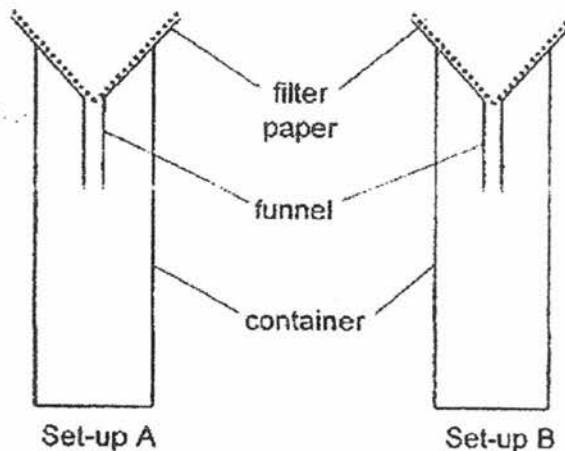

(Go on to the next page)

Particles W and X of the same mass are poured into the set-ups.
 Particle W is poured into set-up A and particle X into set-up B.

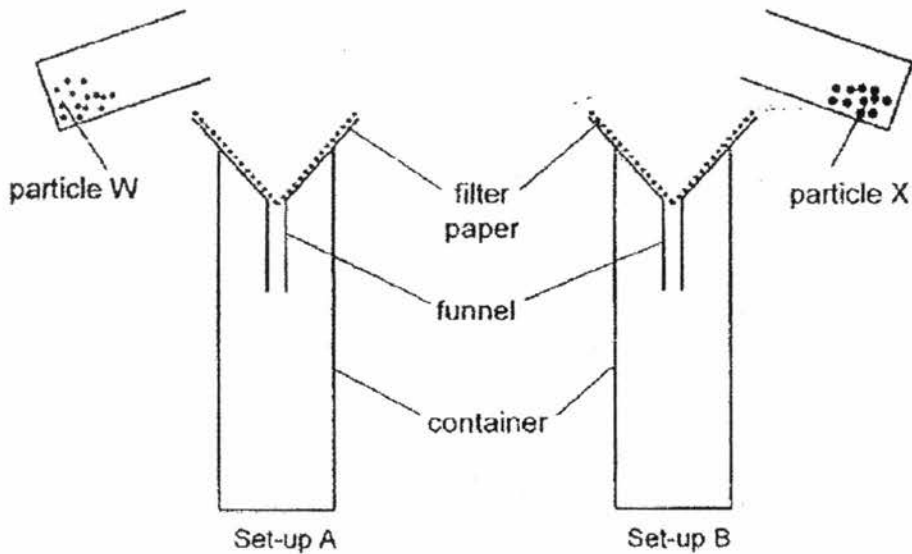

Then the mass of the container without the funnel for each set-up is taken and recorded in the table below.

	Mass of the container at the start of the experiment	Mass of the container at the end of the experiment
Set-up A	750 g	820 g
Set-up B	750 g	750 g

(a) Which part of the cell does the filter paper represent?

(b) What is the function of the cell part given in your answer in part (a)? [1]

(c) Give a reason why the mass of the container in set-up A changes at the end of the experiment. [1]

(Go on to the next page)

(d) Give a reason why the experiment should be conducted a few times? [1]

Score	4
-------	---

30. The diagram below shows a fruit tree covered in netting.

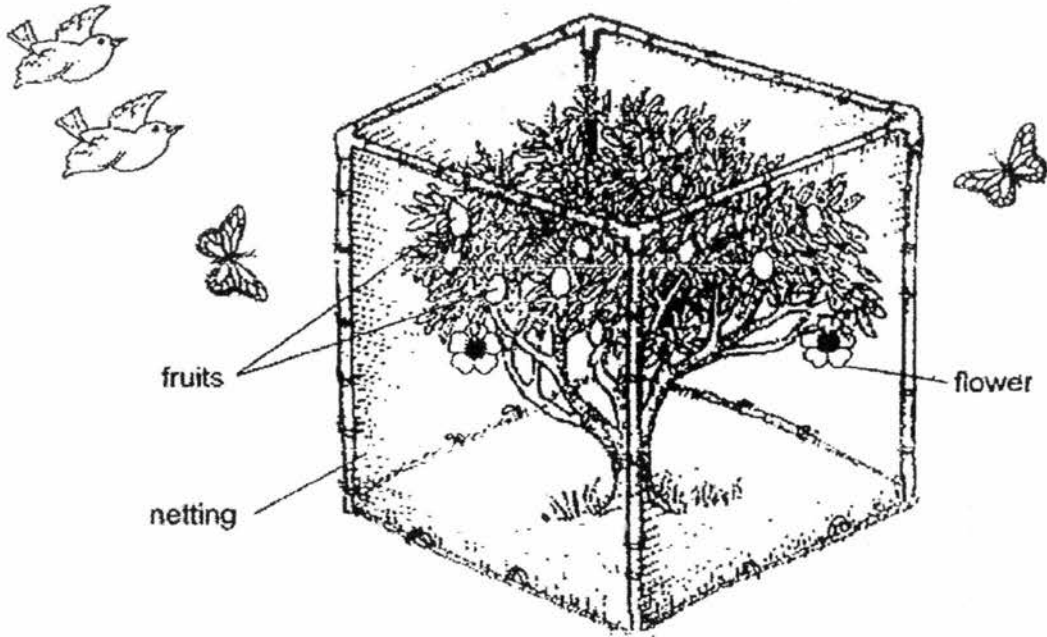

(a) Why must the tree be covered in netting to keep birds away from the fruit? [1]

(b) Give one characteristic of the fruit that allows it to attract the bird. [1]

(c) What is the disadvantage for the tree when it is covered in netting? [1]

Score	3
-------	---

31. The life cycles of the frog and mosquito are shown below.

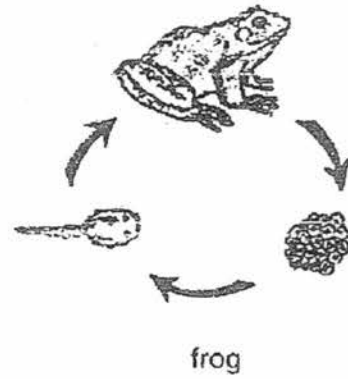
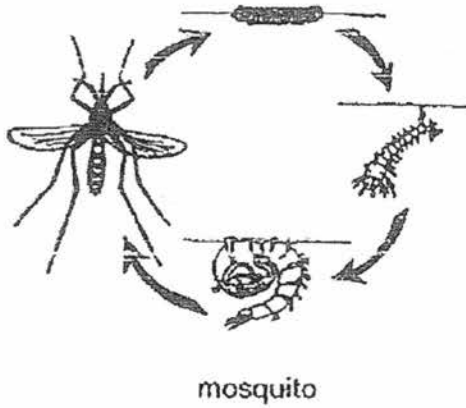

- (a) State one difference between the life cycles of the frog and the mosquito. (Do not compare the organisms.) [1]

- (b) State one similarity between the life cycles of the frog and the mosquito. [1]

- (c) Give a reason why it is easier to catch the pupa of the mosquito than the tadpole of the frog. [1]

Score	3
-------	---

32. The diagram below shows the set-up that Sam used to conduct an experiment to find out how the presence of wind will affect the rate of evaporation.

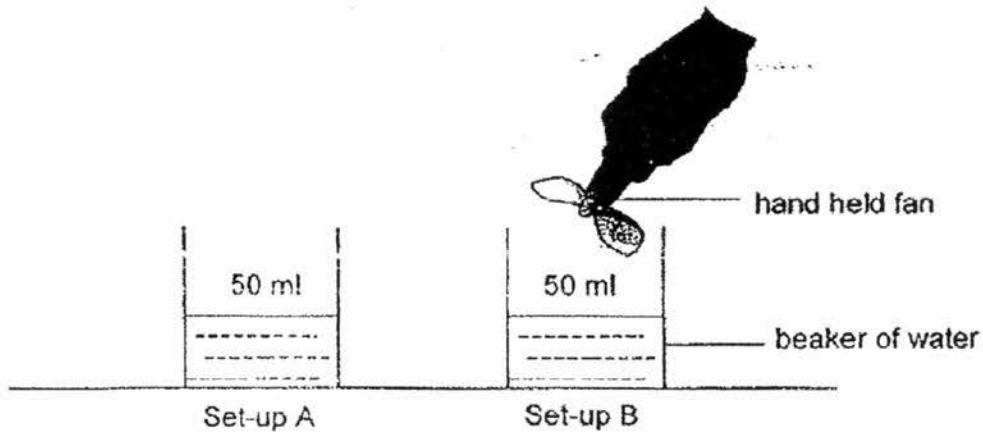

- (a) What is the purpose of set-up A? [1]

Using the same two beakers of water, Sam conducted a second experiment to investigate how the rate of evaporation of water will be affected. He left the set-ups undisturbed in the same room.

The diagram below shows the set-ups.

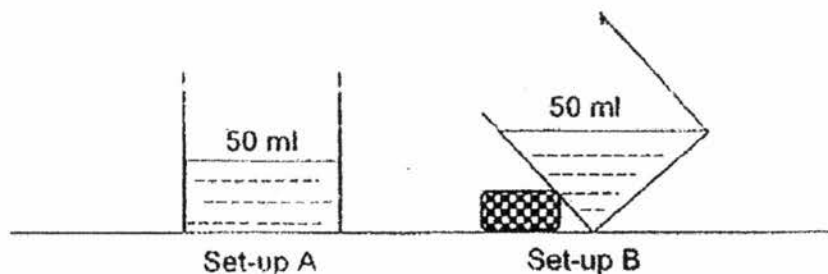

- (b) What is the aim of the experiment? [1]

(Go on to the next page)

(c) Write down two types of data or readings he could collect in order to come to a conclusion? [2]

Score	4
-------	---

33. The diagram below shows the shadow of the wooden stick when the torch was placed at position B.

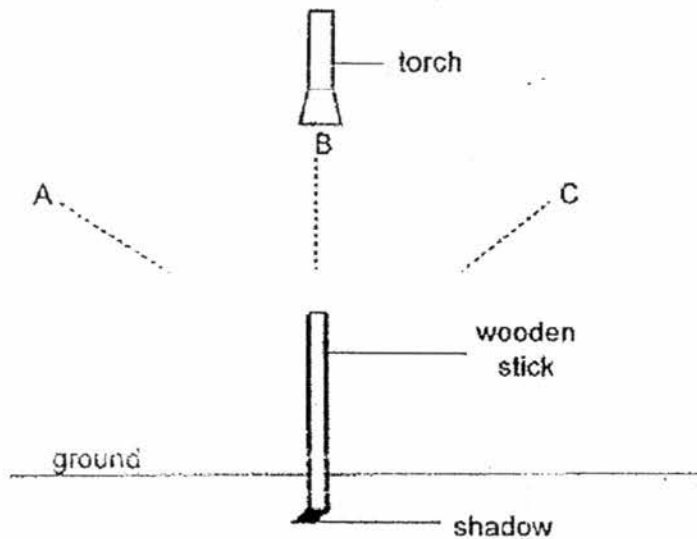

- (a) Put an "X" in the diagram above to show where the shadow will be if the torch is placed at position A. [1]
- (b) If the torch is at position A, what can be done using the torch to form a shorter shadow without moving it to positions B and C? [1]

- (c) The graph below shows the results for the above experiment. Complete the graph by writing the name of the variable changed and the name of the variable measured in the boxes. [2]

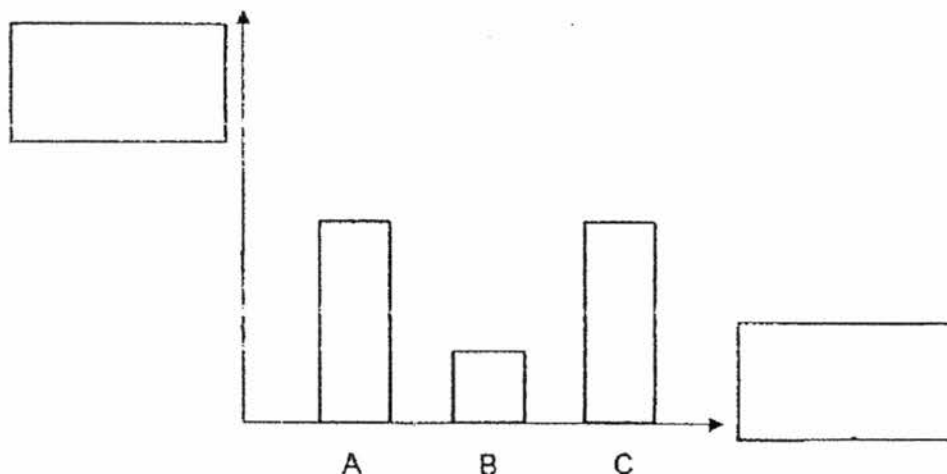

(Go on to the next page)

(d) If two more torches are added to positions A and C, what can be observed? [1]

Score	5
-------	---

34. Two different types of cells are shown in the diagram below.

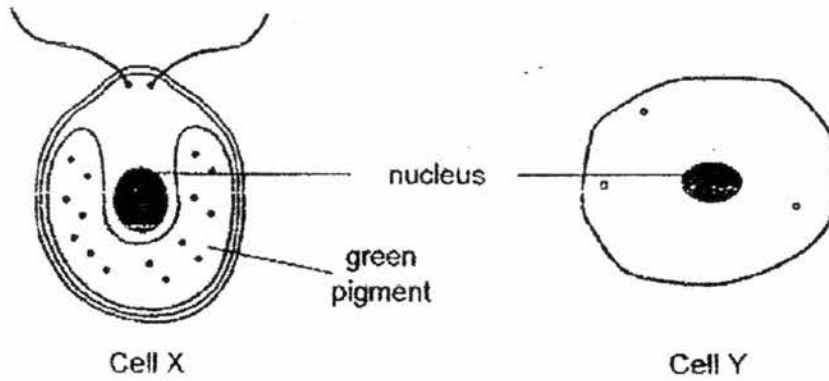

(a) Which cell, X or Y, is likely to be a plant cell? [1]

(b) Give two reasons to support your answer in (a)? [2]

(c) Name one part that is found in both cells X and Y besides the nucleus. [1]

Score	4
-------	---

35. The diagram below shows the cross-section of flower Y.

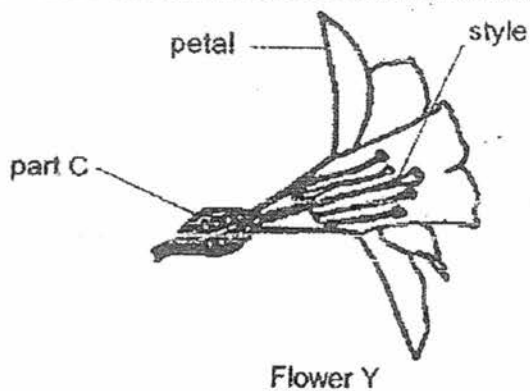

(a) What is the function of part C in the process of reproduction? [1]

(b) The diagram below shows the cross-section of flower X.
Draw an arrow in the diagram to indicate the process of pollination within flower X. [1]

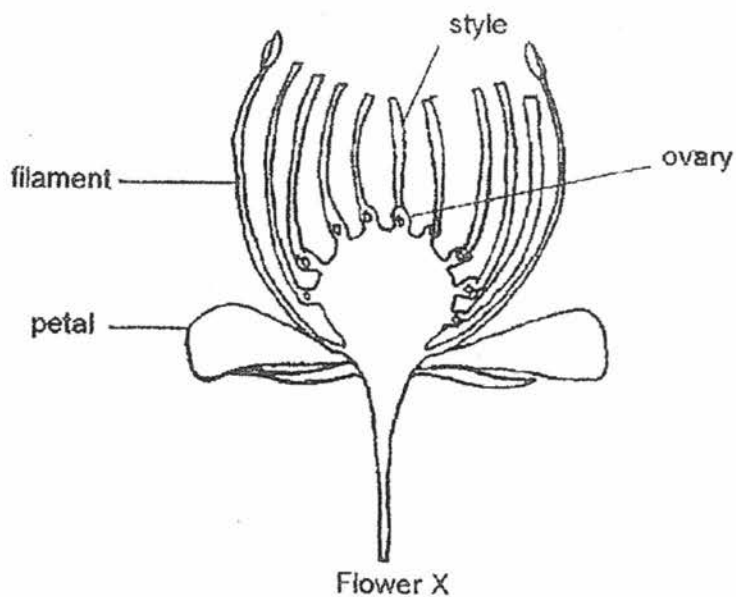

(Go on to the next page)

The fruit from flowers X and Y are shown in the diagram below.

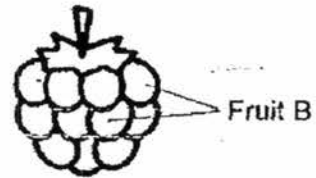
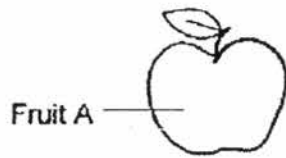

(c) Which one of the fruits, A or B, comes from flower X? Explain your answer clearly. [2]

Score	4
-------	---

36. The diagram below shows animal X and its droppings.



(a) Describe how the seeds of Fruit A ended up in animal X's droppings. [2]

(b) Give a reason why the seedlings that grew around the droppings are healthier. [1]

(c) Other than the seedlings growing healthier, give a reason why the dispersal of seeds is important in the reproduction of plants? [1]

Score	4
-------	---

37. The diagram below shows a set-up used to measure the temperature of the boiling water. After a while, salt was added and the temperature was taken.

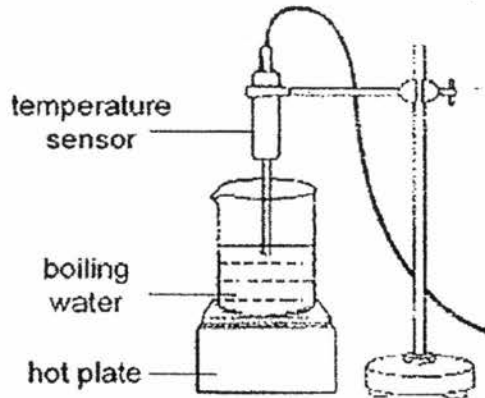

The readings of the temperature of boiling water before and after salt was added was plotted and shown in the graph below.

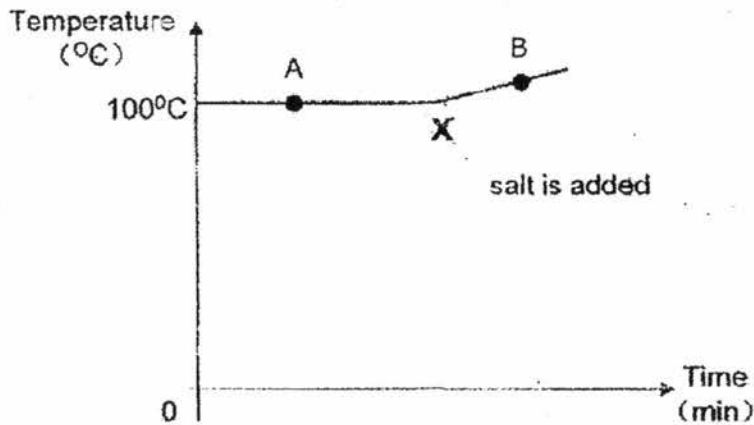

- (a) What is the advantage of using a temperature sensor to measure the temperature of boiling water? [1]

- (b) What happened to the boiling point of water after salt was added? [1]

- (c) At which point, A or B, will food be cooked faster? Explain your answer. [1]

38. The diagram below shows what can be done to get the dented ping pong ball to return to its original shape.

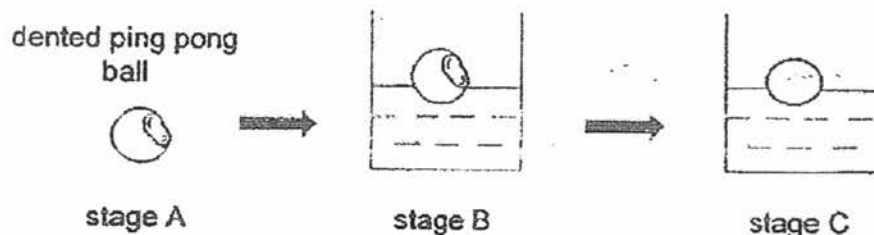

- (a) In stage B, was the ping pong ball put into hot water or cold water to get it to return to its original shape as shown in stage C? Explain your answer. [2]

- (b) Did the mass of the air inside the ping pong ball increase from stage B to C? Give a reason for your answer. [1]

- (c) What will happen to the air inside the ping pong ball if it is put into ice cold water after stage C? [1]

Score	4
-------	---

39. The diagram below shows the heating of a rod made of material A.

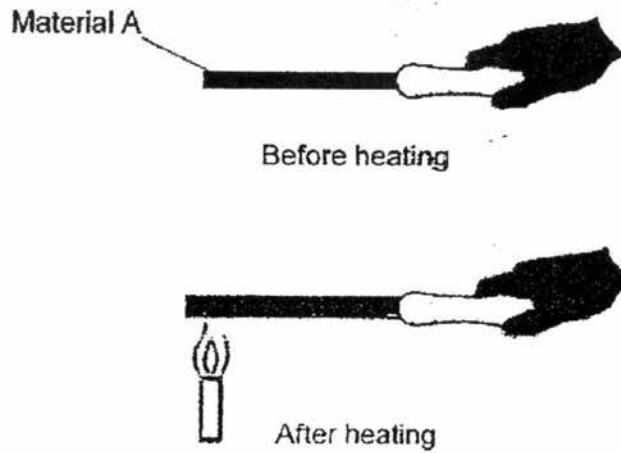

(a) Explain why the rod became bigger after heating?

[1]

Tiles made of Material A were laid on the floor. Tile spacers were put between the tiles as shown in the diagram below.

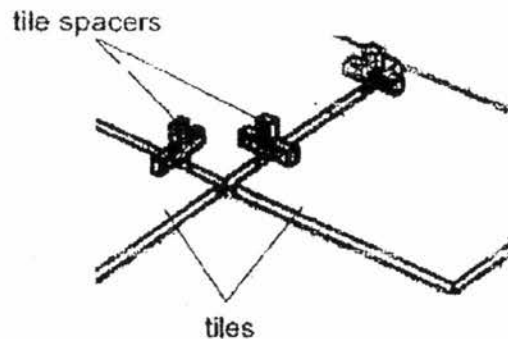

(b) In countries with high temperature, the presence of spaces between the tiles is very important? - Explain why it is important.

[2]

Score	3
-------	---

40. An experiment was conducted to find out the heat conductivity of different materials.

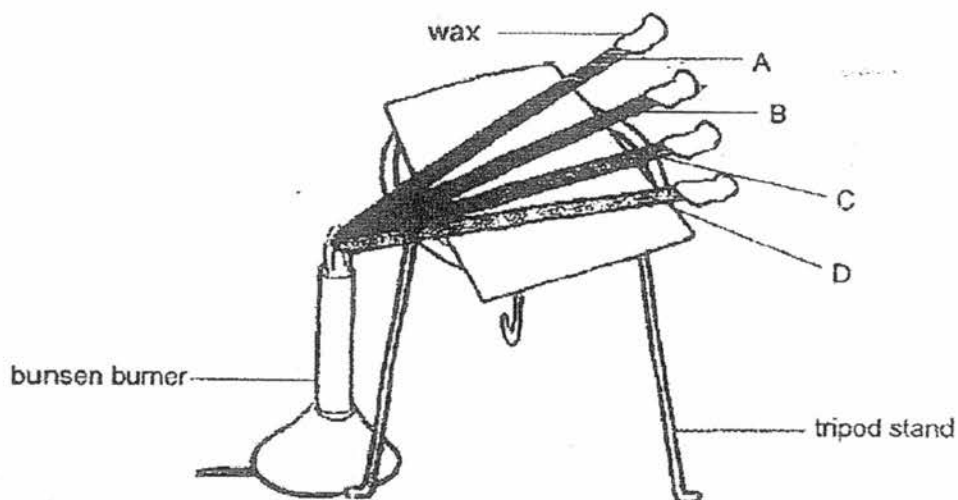

The time taken for the wax to melt completely was recorded in the table below.

Material	Time taken to melt the wax completely (mins)
A	10
B	15
C	48
D	55

(a) Which material is the best conductor of heat? Give a reason for your answer. [1]

(Go on to the next page)

The diagram below shows the cross section of a flask.

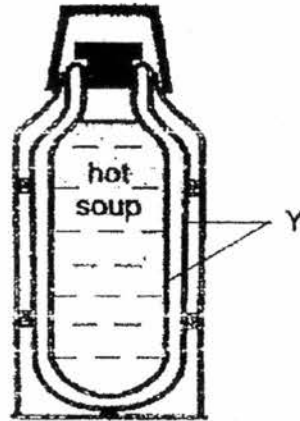

- (b) Which of the four materials, A, B, C or D, should be used to make part Y of the flask in order to keep the soup hot for the longest period of time? Explain your answer clearly. [2]

Score	3
-------	---

End of Paper

EXAM PAPER 2017 (P5)

SCHOOL : Nan Hua

SUBJECT : Science

TERM : CA1

Q1	Q2	Q3	Q4	Q5	Q6	Q7	Q8	Q9	Q10
1	2	3	2	3	3	4	4	2	3
Q11	Q12	Q13	Q14	Q15	Q16	Q17	Q18	Q19	Q20
4	2	2	4	1	3	2	1	4	2
Q21	Q22	Q23	Q24	Q25	Q26	Q27	Q28		
4	4	3	4	2	4	1	2		

29)a)Cell membrane

b)The cell membrane controls the movement of substance in and out of the cell.

c)Particle W pass through the filter paper and is inside the container.

d)To ensure the reliability of the results.

30)a)To not allow birds coming in for food.

b)The sweet and juicy fruit on the tree.

c)The flowers of the tree cannot be pollinated.

31)a)A mosquito has 4 stages in the life cycle but the frog has only 3.

b)Both the young does not look like the adult.

c)The pupa cannot move away while the tadpole can swim.

32)a)Set-up A acts as a control set-up and is used to compare and confirm that the presence of wind affect the rate of evaporation.

b)To find out if the exposed surface area will affect the rate of evaporation.

c)1)Measure the amount of water left in the beaker at the end of the experiment.

2)Measure the time taken for each beaker of water to evaporate 20ml of water.

33)a)

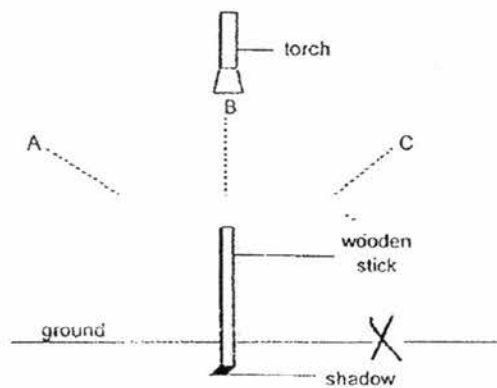

b)Move the torch further away from the wooden stick.

c)

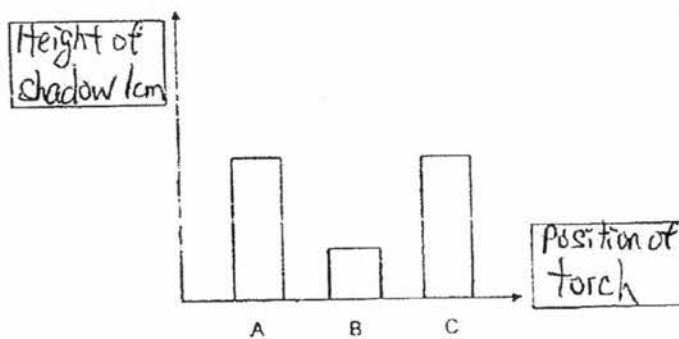

d)There will be 3 shadows.

34)a)Cell X

b)A plant cell has a cell wall and chloroplast, unlike Cell Y.

c)Cell membrane

35)a)The ovary produces the eggs

b)

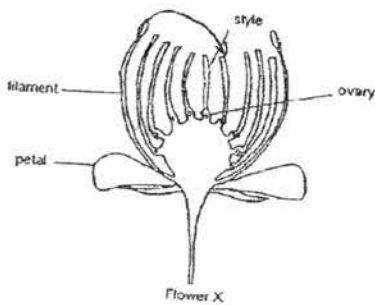

c)Fruit B. Flower X has many ovaries which will developed into many fruits after fertilization.

36)a)Animal X ate the fruit A with the seeds. The seeds are indigestible and passed out the droppings.

b)The droppings will decompose into nutrients and taken in by the seedlings.

c)This is to prevent over crowding so as to reduce competition for water, light, nutrients and space.

37)a)It will help it to be more accurate, as if you hold it with your hands and checking the temperature, the temperature will lost heat to your hands.

b)The boiling point increased

c)Point B. The food will gain more heat and cook faster.

38)a)Hot water. The air inside the ping pong ball will gain heat from the hot water and expand. The expanded air will push the dent out.

b)No. The mass of air did not increase as no air was removed or added in ping pong ball.

c)The air in the ping pong ball will lose heat to the cold water and contract.

39)a)The rod gain heat from the burner and expands.

b)When the tiles gain heat from the surroundings and expand, the space provides room for expansion thus the tile will not buckle.

40)a)Material A. It took the least time to melt the wax.

b)Material D. It took the longest time to melt the wax completely as it is poorest conductor of heat. It will take the most time for the hot soup to lose heat to the surroundings.