



AI TONG SCHOOL

2010

Semestral ASSESSMENT 2

PRIMARY 5

MATHEMATICS

Paper 1

DURATION : 50 min

DATE : 28 October 2010

INSTRUCTIONS

Do not open the booklet until you are told to do so.

Follow all instructions.

Answer all questions.

You are ^{allowed} to use a calculator.

Name : _____ ()

Class : Primary 5 _____

Parent's Signature :	_____
Date :	_____

Marks:

Paper 1	40
Paper 2	60
Total	100

Paper 1
Booklet A

Questions 1 to 10 carry 1 mark each. Questions 11 to 15 carry 2 marks each.
For each question, four options are given. One of them is the correct answer.
Make your choice (1, 2, 3 or 4). Shade the oval (1, 2, 3 or 4) on the Optical Answer Sheet.
(20 marks)

1 $6\,000\,000 + 50\,000 + 200 + 8 = \underline{\hspace{2cm}}$

- (1) 6 005 028
- (2) 6 050 028
- (3) 6 050 208
- (4) 6 500 208

2 Express 7 l 28 ml in litres.

- (1) 0.728 l
- (2) 7.028 l
- (3) 7.208 l
- (4) 7.28 l

3 How many hundredths are there in 7.29?

- (1) 9
- (2) 29
- (3) 729
- (4) 7290

4 What is the value of $\frac{2}{5} \times \frac{5}{6}$?

- (1) $\frac{1}{3}$
- (2) $\frac{7}{11}$
- (3) $\frac{7}{30}$
- (4) $\frac{10}{11}$

5 $3 : 14 = \boxed{?} : 56$. What is the missing number in the box?

- (1) 14
- (2) 12
- (3) 7
- (4) 4

6 What percentage of 25 km is 500m?

- (1) 2%
- (2) 5%
- (3) 20%
- (4) 50%

7 9 equal pieces of ribbon were cut from a $\frac{5}{8}$ m long ribbon. How long was each piece of ribbon?

- (1) $\frac{5}{72}$ m
- (2) $\frac{8}{45}$ m
- (3) $5\frac{5}{8}$ m
- (4) $14\frac{2}{5}$ m

8 In the figure below, identify the height of triangle QRS if its base is RS.

- (1) RV
- (2) QR
- (3) QS
- (4) PS

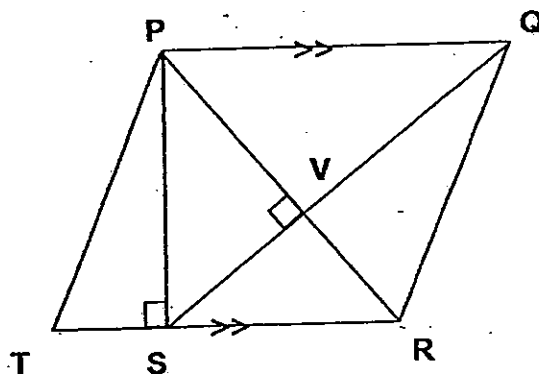

- 9 45 scouts were supposed to stay back to help clean up the store room. In the end, only $\frac{7}{15}$ of them did so. How many scouts did not stay back to help?
- (1) 21
 (2) 24
 (3) 30
 (4) 38

- 10 In the figure shown, AB, CD, EF, GH are straight lines. If $\angle a = 25^\circ$, what is the value of $\angle c + \angle d + \angle f$?

- (1) 135°
 (2) 155°
 (3) 310°
 (4) 335°

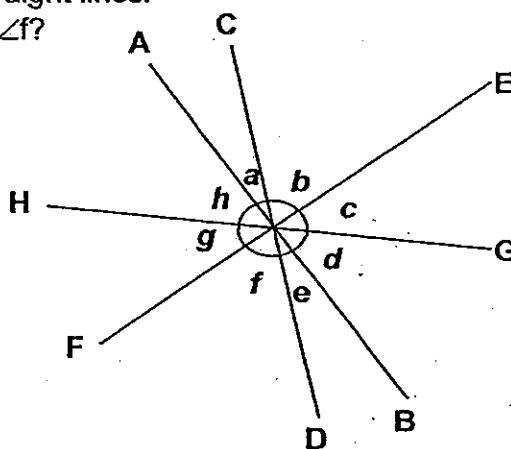

- 11 The table below shows taxi charges on Long Island.

Metered fare (by distance)	Charges
1 st km or part thereof	\$3.00
Every subsequent 100m or part thereof	\$0.20
Surcharges	
Evening Peak Hour Surcharge (applicable upon boarding between 5pm and 7.30pm)	10% of metered fare

Mr Chandra boarded a taxi at 6.20pm for an 11-kilometre trip home from his office. How much did he have to pay for the trip?

- (1) \$3.52
 (2) \$5.50
 (3) \$25.30
 (4) \$36.30

- 12 Dawn and Emily share some beads in the ratio 11 : 7. They have the same number of beads after Dawn gives Emily 18 beads. How many beads do they have in all?
- (1) 324
(2) 198
(3) 162
(4) 126
- 13 Mrs Lim had a total of \$360, consisting of \$10 and \$2 notes. Given that she had four times as many \$2 notes as \$10 notes, how many \$10 notes did she have?
- (1) 36
(2) 30
(3) 20
(4) 18
- 14 After spending \$5.20 on a book and \$2.80 on a pen, Jun Heng had \$12 left. What percentage of his money did he spend?
- (1) $33\frac{1}{3}\%$
(2) 40%
(3) 60%
(4) $66\frac{2}{3}\%$
- 15 A cubic tank of sides 40cm is filled with 8 litres of water. How much more water is needed to fill the tank completely? ($1\text{ l} = 1000\text{ cm}^3$)
- (1) 56 l
(2) 32 l
(3) 8 l
(4) 5 l

Booklet B

Questions 16 to 25 carry 1 mark each. Write your answers in the spaces provided. For questions which require units, give your answers in the units stated. (10 marks)

16 $1.798 \times 1000 = \square \div 100$. What is the missing number in the box?

Ans: _____

17 Round off the product of 6589 and 7 to the nearest thousand.

Ans: _____

18 What is the value of $36 + (94 - 10) \div 6 - 8$?

Ans: _____

19 Express 20 minutes as a fraction, in its simplest form, of 3 hours.

Ans: _____

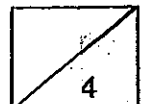

20 Express 0.016 as a percentage.

Ans: _____ %

21 A cat weighs 4.2 kg. A dog weighs 638g more than the cat. What is the total mass of the two animals?

Ans: _____ kg

22 There are 3 pieces of wire. The first piece is $\frac{3}{5}$ as long as the 2nd piece but twice as long as the 3rd piece. Express the length of the longest piece of wire as a fraction of the combined length of all 3 pieces.

Ans: _____

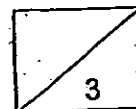

- 23 72% of the audience in a concert are males and the rest are females. $\frac{1}{3}$ of the males are boys and $\frac{1}{4}$ of the females are girls. What percentage of the audience are children?

Ans: _____ %

- 24 ABC is an isosceles triangle. Find $\angle b$.

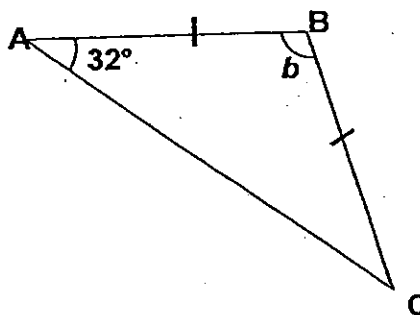

Ans: _____ °

- 25 In the figure below, DEFG and DEHG are trapeziums. EH is perpendicular to DE. Find $\angle e$.

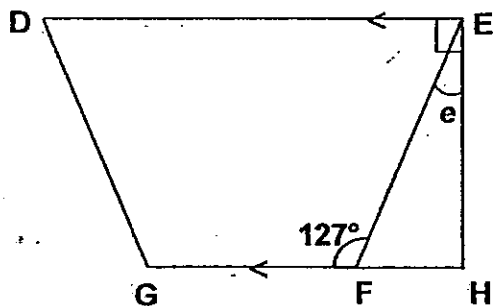

Ans: _____ °

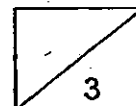

Questions 26 to 30 carry 2 marks each. Show your working clearly in the space provided for each question and write your answers in the spaces provided. For questions which require units, give your answers in the units stated. (10 marks)

- 26 The average of 8 numbers is 21. If 7 of the numbers have an average of 19, what is the 8th number?

Ans: _____

- 27 At first, there were 3000 cm^3 of water in $\frac{5}{12}$ of a tank. Then, a tap was turned on and water flowed into the tank at a rate of 500 cm^3 per minute. How many minutes did it take for the rest of the tank to be completely filled with water from the tap?

Ans: _____ min

- 28 In the figure, not drawn to scale, what is $\angle a + \angle b + \angle c + \angle d$?

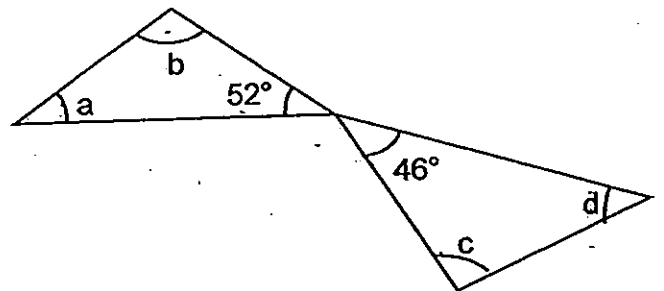

Ans: _____ °

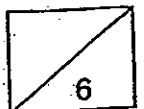

- 29 The figure below is not drawn to scale. ACEF is a square. $AB = DE$. AB is half as long as BC. Find the area of the shaded triangle BFG.

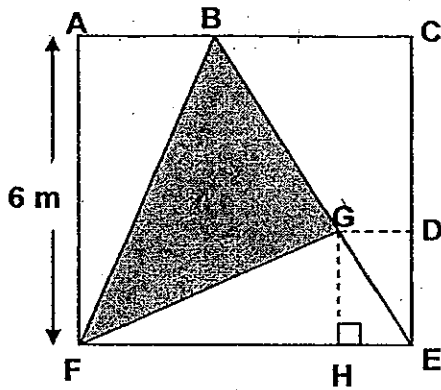

Ans: _____ m^2

- 30 The solid below, not drawn to scale, is made up of identical cubes of side 3 cm. How many more such cubes are needed to build a cuboid with the measurements 12 cm by 9 cm by 15 cm?

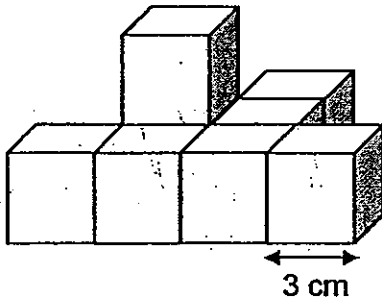

Ans: _____

End of Paper 1

— CHECK YOUR WORK CAREFULLY —

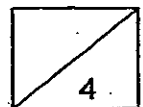



AI TONG SCHOOL

2010

Semestral ASSESSMENT 2

PRIMARY 5

MATHEMATICS
Paper 2

DURATION : 1 h 40 min

DATE : 28 October 2010

INSTRUCTIONS

Do not open the booklet until you are told to do so.

Follow all instructions.

Answer all questions.

You are allowed to use a calculator.

Name : _____

Class : Primary 5 _____

Parent's Signature : _____
Date : _____

Marks:

Paper 2	60
---------	----

Paper 2

Questions 1 to 5 carry 2 marks each. Show your working clearly in the space provided for each question and write your answers in the spaces provided.

For questions which require units, give your answers in the units stated. (10 marks)

1 Here are seven cards with numbers and operation signs:

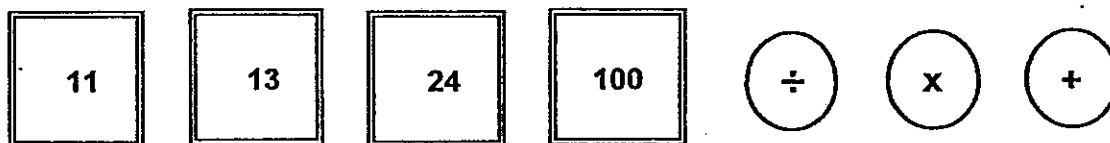

Use all the cards to form a number sentence with the answer 100 :

$$\square \circ (\square \circ \square) \circ \square = 100$$

~~*~~ I am thinking of 2 numbers, A and B. $\frac{1}{3}$ of A has the same value as $\frac{5}{6}$ of B. If their difference is 36, what is their sum?

Ans: _____

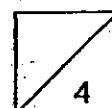

- 3 In April, 25% of a class of 36 pupils are girls. In May, 9 girls enrol in this class. In May, what percentage of the class are girls?

Ans: _____ %

- 4 Megan and Li Ting share 296 stickers. Megan has 104 more stickers than Li Ting. What is the ratio of the number of Megan's stickers to the number of Li Ting's stickers?

Ans: _____

- 5 A cuboid has 2 identical square faces and 4 identical rectangular faces. The area of each square face is 144 cm^2 and the area of each rectangular face is 432 cm^2 . Find the volume of the cuboid.

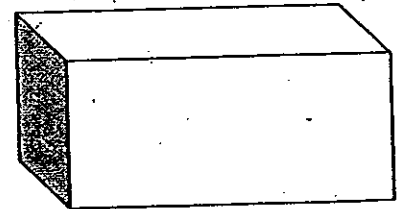

Ans: _____ cm^3



For questions 6 to 18, show your working clearly in the space provided for each question and write the answers in the spaces provided.
The number of marks available is shown in the brackets [] at the end of each question or part-question. (50 marks)

- 6 In the figure below, UV and XY are straight lines. The ratio of the size of $\angle UOX$ to the size of $\angle XOY$ is 1 : 3. Find $\angle ZOY$.

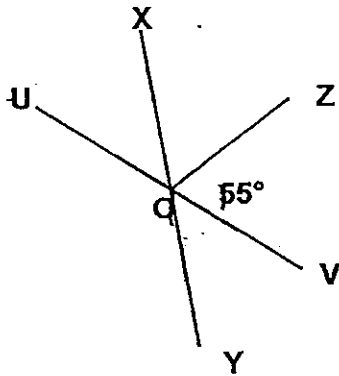

Ans: _____ [3]

- 7 Draw a triangle ABC such that $AB = BC = 5$ cm and $\angle ABC = 160^\circ$.
Label it clearly [2].

How long is AC? Give your answer to the nearest centimetre.

Ans: AC = _____ [1]

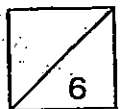

- 8 Lisa and Mona's total mass is 51kg. Mona and Nizam's total mass is 81kg. Nizam is three times as heavy as Lisa. What is the average mass of the three friends?

Ans: _____ [3]

- 9 ABCD is a rectangle. It is divided into 4 unequal triangles P, Q, R and S which meet at a point as shown. Find the area of triangle S.

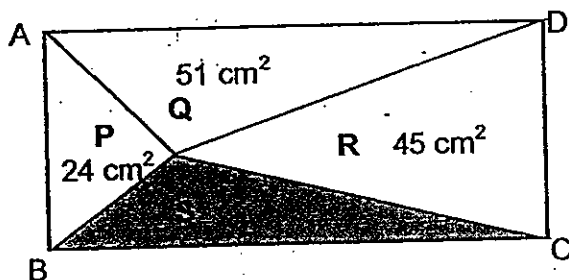

Ans: _____ [3]

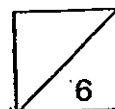

- 10 40 children in Class 5L sold an average of 19 charity tickets. There were 8 more boys than girls in the class. The average number of charity tickets sold by the boys was 15. Find the average number of charity tickets sold by the girls.

Ans: _____ [3]

- 11 The figure below, not drawn to scale, is made up of a parallelogram and 2 triangles.
 $RS = ST$. Find
 (a) $\angle QPS$
 (b) $\angle STR$

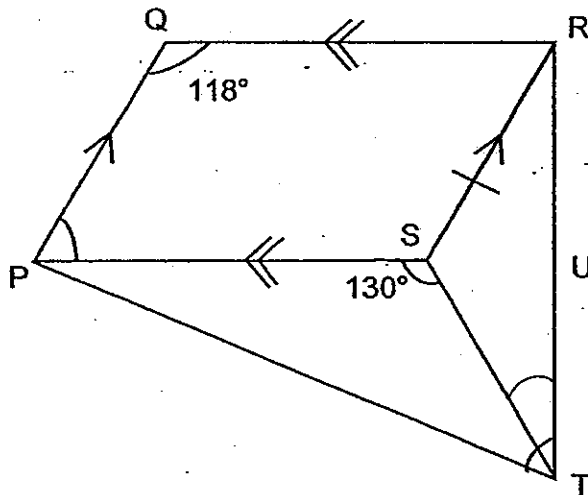

Ans: (a) _____ [1]

(b) _____ [2]

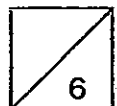

112 Rosie, Sandy and Tabby shared a box of cards. Rosie took $\frac{1}{5}$ of the total number of cards and another 12 cards. Sandy took 50% of the remaining cards in the box and another 13 cards. Tabby took the last 27 cards in the box. How many cards were there in the box at first?

Ans: _____ [4]

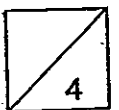

- 13 The Residents' Committee was planning how to arrange chairs and square tables for a mass dinner in a long hall. They drew and numbered some arrangements and wrote down some notes as shown:

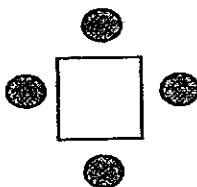

Arrangement 1

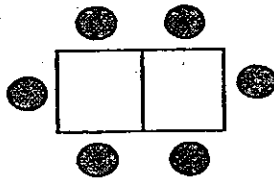

Arrangement 2

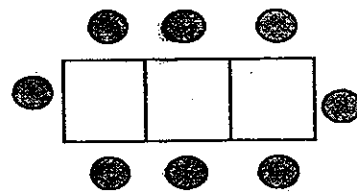

Arrangement 3

Notes:

Arrangement number	Number of tables	Number of chairs
1	1	4
2	2	6
3	3	8

If the arrangement was continued in the same pattern,

- how many chairs were needed if 5 tables were joined together?
- how many chairs were needed if 20 tables were joined together?
- which arrangement would require 100 chairs?

Ans: (a) _____ [1]

(b) _____ [1]

(c) _____ [2]



- 14 The figure below, not drawn to scale, shows a rectangular piece of paper. The piece of paper is later folded as shown. Find $\angle x$ and $\angle y$.

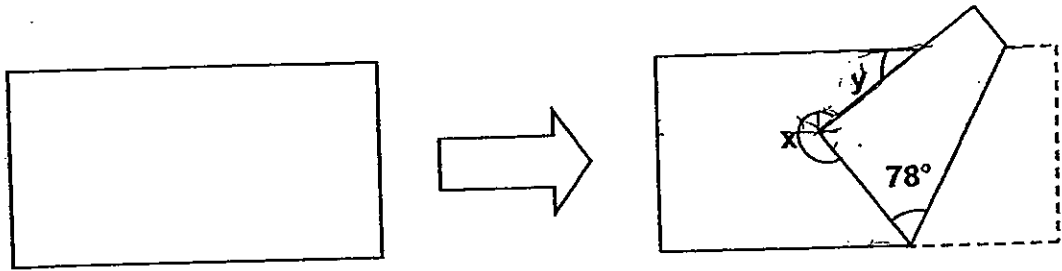

Ans: $\angle x =$ _____ [1]

$\angle y =$ _____ [3]



- 15 608 children took part in a skipping competition. Altogether 110 'Gold' awards were presented to $\frac{1}{5}$ of the boys and $\frac{1}{7}$ of the girls. How many boys took part in the competition?

Ans: _____ [5]

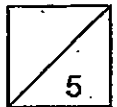

- 16 Agnes made some fruit pies. She gave some of them to her neighbour and collected \$14.40 after selling $\frac{3}{5}$ of the remaining pies for \$1.20 each. She then had $\frac{1}{5}$ of the original number of fruit pies left. How many fruit pies did she give her neighbour?

Ans: _____ [5]

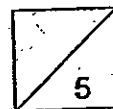

17

The ratio of Steven's cards to Benny's cards was 3 : 4. After Steven bought another 9 cards and Benny lost 18 cards, the ratio became 3 : 2. Find the total number of cards Steven and Benny had at first.

Ans: _____ [5]

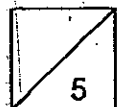

- 18 The figure below, not drawn to scale, is made up of rectangle JKLM and triangle JKY. JK is 10 cm long. WY is 12.8 cm long and it is also perpendicular to JK. 75% of JKY and $\frac{4}{7}$ of JKLM is shaded. What is the length of JM?

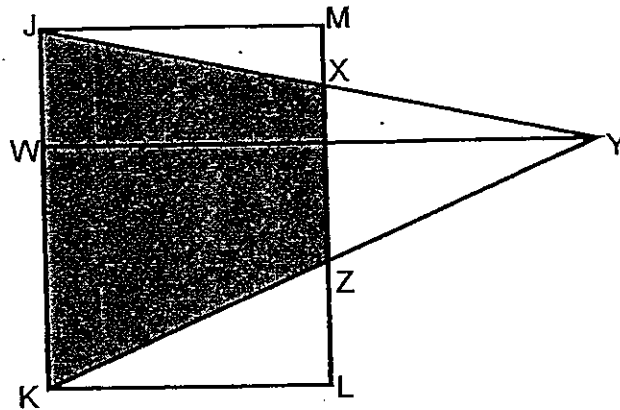

Ans: _____ [5]

End of Paper 2

— CHECK YOUR WORK CAREFULLY —

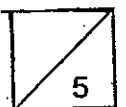



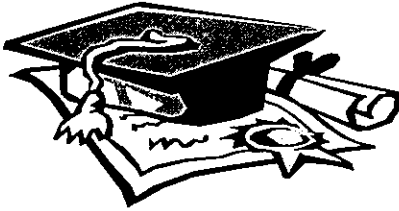

ANSWER SHEET

EXAM PAPER 2010

SCHOOL : AITONG PRIMARY
SUBJECT : PRIMARY 5 MATHEMATICS

TERM : SA2

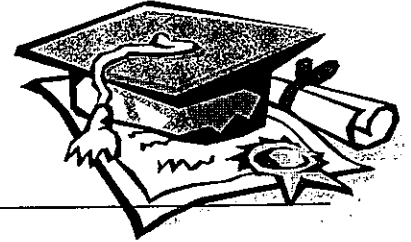

Q1	Q2	Q3	Q4	Q5	Q6	Q7	Q8	Q9	Q10	Q11	Q12	Q13	Q14	Q15
3	2	3	1	2	1	1	4	2	2	3	3	3	2	1

- 16)179800 17)46000 18)42 19)1/9 20)1.6%
- 21)9.038kg 22)10/19 23)31% 24)116° 25)37°
- 26)35 27)8.4min 28)262° 29)12m² 30)52

Paper 2

- 1)100 ÷ 13 + 11 × 24 2)84 3)40% 4)25:12 5)5184cm³
- 6)100° 7)AL = 100cm 8)32kg 9)18cm² 10)25
- 11)a)62°
b)34°
- 12)115
- 13)a)12
b)42
c)49
- 14)X = 270°
Y = 66°
- 15)110 16)20 17)84
- 18)8.4cm

