

Name : _____ ()

Class : Primary 5 _____

CHIJ ST NICHOLAS GIRLS' SCHOOL



Primary 5

Semestral Assessment 2 – 2009

Mathematics

Paper I

Booklet A

28 September 2009

**15 QUESTIONS
20 MARKS**

INSTRUCTIONS TO CANDIDATES

TOTAL TIME FOR PAPER 1 : 50 MINUTES

DO NOT OPEN THIS BOOKLET UNTIL YOU ARE TOLD TO DO SO.

FOLLOW ALL INSTRUCTIONS CAREFULLY.

ANSWER ALL QUESTIONS. YOU ARE NOT ALLOWED TO USE A CALCULATOR.

This paper consists of 6 printed pages including the cover page.

Booklet A: Multiple Choice Questions (20 marks)

Questions 1 to 10 carry 1 mark each.

Questions 11 to 15 carry 2 marks each.

For each question, four options are given. One of them is the correct answer. Make your choice (1, 2, 3 or 4). Shade the correct oval (1, 2, 3, 4) on the Optical Answer Sheet (OAS).

1) The digit 6 in 9 060 387 has a value of _____.

1) 60

2) 600

3) 6 000

4) 60 000

2) $5\frac{11}{12} = 4 + \boxed{} + \frac{1}{6}$. What is the missing number in the box?

1) $\frac{10}{12}$

2) $\frac{21}{12}$

3) $\frac{32}{12}$

4) $\frac{9}{12}$

3) The number of boys is $\frac{2}{3}$ the number of girls in a class. What is the ratio of the number of girls to the total number of pupils in the class?

1) 2 : 3

2) 3 : 2

3) 2 : 5

4) 3 : 5

- 4) PQRS is a rectangle. Find the area of triangle HPS.

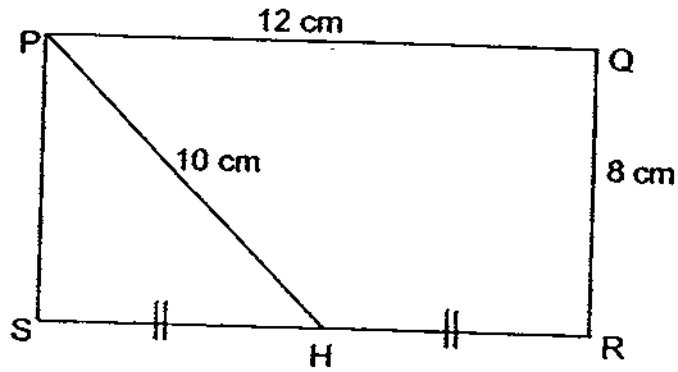

- | | |
|----------------------|----------------------|
| 1) 24 cm^2 | 2) 30 cm^2 |
| 3) 40 cm^2 | 4) 48 cm^2 |

- 5) Divide 78.069 by 3.

- | | |
|----------|-----------|
| 1) 262.3 | 2) 260.23 |
| 3) 26.23 | 4) 26.023 |

- 6) Find the average of 23, 16, 0, 35 and 7.

- | | |
|----------|----------|
| 1) 16.20 | 2) 20.25 |
| 3) 40.50 | 4) 81.00 |

7) Geraldine can read $\frac{3}{5}$ of a book in 3 days. At this rate, how many books can she read in 5 weeks?

- 1) 1 book
- 2) 7 books
- 3) 10 books
- 4) 15 books

8) Express 0.07 as a percentage.

- 1) 0.007%
- 2) 0.07%
- 3) 0.7%
- 4) 7.0%

9) In the figure below, not drawn to scale, AB and CD are straight lines. Find $\angle COT$.

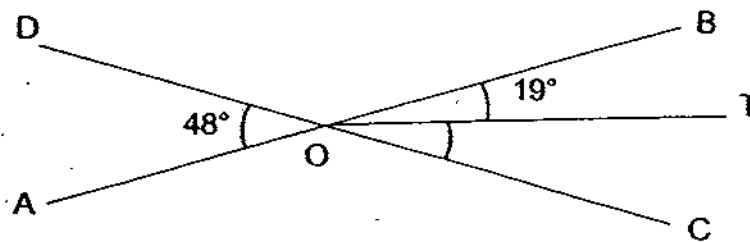

- 1) 29°
- 2) 67°
- 3) 132°
- 4) 161°

- 10) KLMN is a rectangle. Given that the area of triangle TLM is 28 cm^2 , find the shaded area.

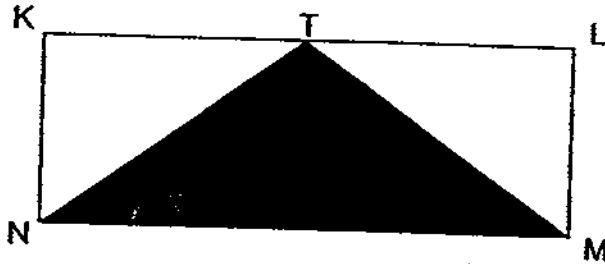

- 1) 14 cm^2 2) 28 cm^2
3) 56 cm^2 4) 112 cm^2
- 11) When 5 is added to $\frac{2}{7}$ of a number, the result is 19. What is the number?
- 1) 35 2) 49
3) 60 4) 84
- 12) The ratio of the number of comics Kenny had to the number of comics Henry had was 3 : 9. Henry had 48 more comics than Kenny. How many comics must Henry give to Kenny so that each of them has an equal number of comics?
- 1) 8 2) 12
3) 16 4) 24

13) The average mass of 5 girls was 52 kg. The first 3 girls had a mass of 43 kg, 60 kg and 59 kg respectively. What was the average mass of the remaining 2 girls?

1) 47 kg

2) 49 kg

3) 54 kg

4) 64 kg

14) Caleb has three types of DVDs. $\frac{1}{5}$ of his DVDs are cartoons, 36% are movies and the rest are documentaries. He has 250 DVDs altogether. How many more documentaries than cartoons does he have?

1) 20

2) 40

3) 60

4) 110

15) Tammy has 38 bags. Tania has 12 more bags than Tammy. What percentage of Tania's bags must Tania give Tammy so that both of them have the same number of bags?

1) 12%

2) 24%

3) 64%

4) 88%

Name : _____ ()

Class : Primary 5 _____

CHIJ ST NICHOLAS GIRLS' SCHOOL



Primary 5

Semestral Assessment 2 – 2009

Mathematics

Paper 1

Booklet B

28 September 2009

**15 QUESTIONS
20 MARKS**

Booklet A	20
Booklet B	20
Paper 1	40

INSTRUCTIONS TO CANDIDATES

TOTAL TIME FOR PAPER 1 : 50 MINUTES

DO NOT OPEN THIS BOOKLET UNTIL YOU ARE TOLD TO DO SO.

FOLLOW ALL INSTRUCTIONS CAREFULLY.

ANSWER ALL QUESTIONS. YOU ARE NOT ALLOWED TO USE A CALCULATOR.

This paper consists of 7 printed pages including the cover page.

Booklet B: Short Answers (20 marks)

Questions 16 to 25 carry 1 mark each.
Questions 26 to 30 carry 2 marks each.

Write down your answers in the answer blanks provided. Give your answers in the units stated.

Do not
write in
this spa

16) 8 743 hundreds, 63 tens and 70 ones = _____ hundreds

Ans: _____

17) 5 children shared $\frac{10}{13}$ of a cake. What fraction of the cake did each child get?

Ans: _____

18) The length of AB is $\frac{1}{3}$ of AC. Find the area of the shaded part.

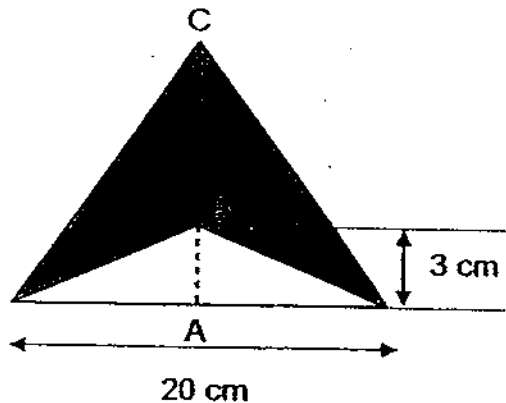

Ans: _____ cm²

Do
wri
this

19) Ben swam 15 laps in the morning and 10 more laps in the evening than in the morning. Express the ratio of the number of laps Ben swam in the evening to the total number of laps he swam that day.

Ans: _____

20) A litre of detergent costs \$6.90. What is the cost of 300 mℓ of the detergent?

Ans: \$ _____

21) Natalie took 25 seconds to run 100 m. How many kilometres had she run after 200 seconds?

Ans: _____ km

22) In a test, Amber, Betty and Cathy obtained an average of 89 marks. Amber obtained 77 marks and Cathy obtained 92 marks. How many marks did Betty obtain?

Ans: _____



- 23) Express $\frac{288}{560}$ as a percentage. Round off your answer to the nearest whole number.

Ans: _____ %

- 24) DSF is a straight line. $\angle FSM = \angle DSE = 27^\circ$. Find $\angle MSE$.

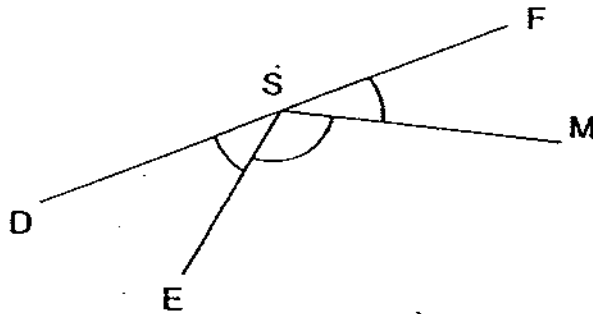

Ans: _____

Do not
write
this s

Do not
write in
this sp.

- 25) Mrs Gomes went shopping with \$112. She spent 15% of the money on a bag, $\frac{1}{4}$ of the money on shoes and the rest of the money on clothes. How much money did she spend on clothes?

Ans: \$ _____

26)

$$\text{☀} + \text{☀} + \text{☀} = \frac{9}{14}$$

What is $\text{☀} \times \text{☀}$?

Ans: _____

- 27) The ratio of the length to the breadth of a rectangle is 7 : 5. The length of the rectangle is 28 cm. Find the ratio of the breadth to the perimeter of the rectangle.

Ans: _____

Do not
write
this s

- 28) Ramid bought a MP4 player and a card reader at a road show. The MP4 player costs \$187 and the card reader costs $\frac{1}{10}$ as much as the MP4 player. How much change would Ramid receive if he gave the cashier \$250?

Ans: \$ _____

- 29) The carpark charges at Golden Shopping Centre are as below:

First 10 minutes	Free
Next $\frac{1}{2}$ hour	\$1.20
Subsequent $\frac{1}{2}$ hour or part thereof	\$1.00 per $\frac{1}{2}$ hour

How much does it cost for Vivian to park her car there from 2.35 p.m. to 6.10 p.m.?

Ans: \$ _____

- 30) The usual price of a bicycle is \$280. David bought the bicycle at a discount of 10%. In addition, he had to pay 7% GST on the discounted price. How much did he pay for the bicycle in the end?

Ans: \$ _____

Do not
write
this s

End of Paper 1

Name : _____ ()

Class : Primary 5 _____

CHIJ ST NICHOLAS GIRLS' SCHOOL



Primary 5

Semestral Assessment 2 – 2009

Mathematics

Paper 2

28 September 2009

Parent's Signature

**18 QUESTIONS
60 MARKS**

Paper 1	40
Paper 2	60
Total	100

INSTRUCTIONS TO CANDIDATES

TOTAL TIME FOR PAPER 2 : 1 HOUR 40 MINUTES

DO NOT OPEN THIS BOOKLET UNTIL YOU ARE TOLD TO DO SO.

FOLLOW ALL INSTRUCTIONS CAREFULLY.

ANSWER ALL QUESTIONS. YOU ARE ALLOWED TO USE A CALCULATOR.

This paper consists of 12 printed pages including the cover page.

Short Answers (10 marks)

Questions 1 to 5 carry 2 marks each.

Write your answers in the answer blanks provided.

Give your answers in the units stated.

Do not
write in
this sp

- 1) Mrs Goh bought two bags of rice of the same brand. One bag cost \$13.85 and the other cost \$8.35. The total mass of the rice in the two bags was 15 kg. What was the price of 1 kg of rice?

Ans : \$ _____

- 2) The sides of a triangle are in the ratio 3 : 4 : 7. If the perimeter is 105 cm, find the length of the shortest side.

Ans : _____ cm

- 3) Tommy paid \$39.44 for 24 blue pens and 22 purple pens. The total cost of 1 blue pen and 1 purple pen was \$1.68. How much did 1 purple pen cost?

Ans : \$ _____



- 4) The figures below show three wooden blocks, M, A and C. Given that the total length of all the wooden blocks is 328 m, find the length of A.

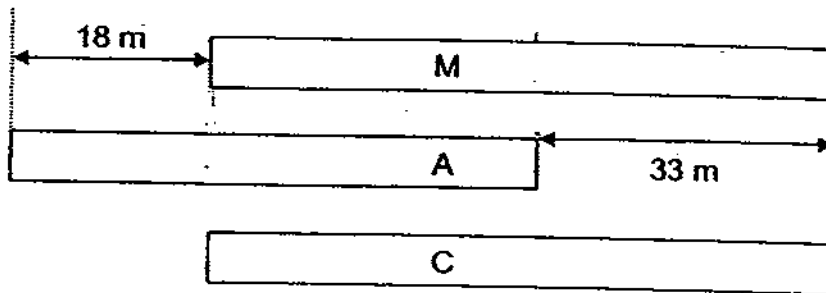

Ans : _____

- 5) Given that $KLQR$ is a square and $\angle KNL = 48^\circ$, find the ratio of $\angle QPN$ to $\angle KLM$.

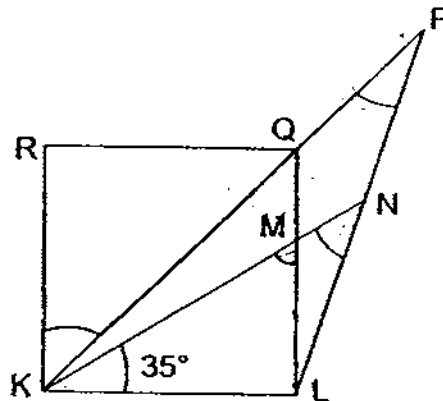

Ans : _____

Long Answers (50 marks)

For questions 6 to 18, show your working clearly in the space below each question and write your answer in the spaces provided. The number of marks available is shown in the brackets () at the end of each question or part-question.

- 6) The parallelogram below is not drawn to scale. Given that $\angle BDC = 31^\circ$, find $\angle DBC$.

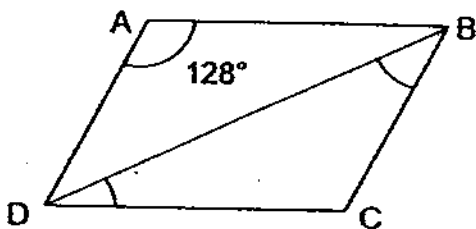

Ans: _____ (3 m)

- 7) The figure below is not drawn to scale. JK is a straight line. Find the difference between $\angle y$ and $\angle z$.

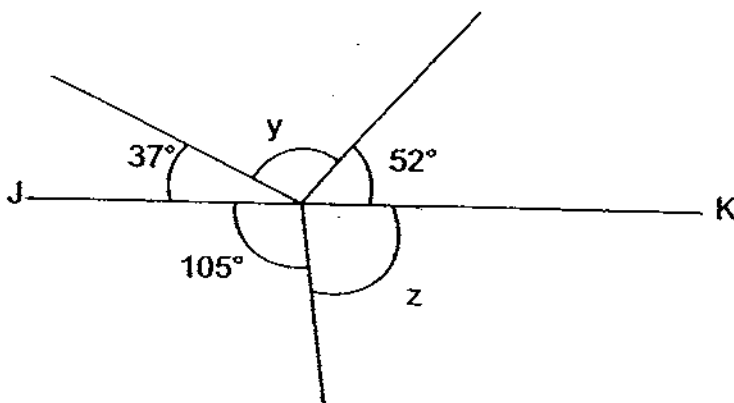

Ans: _____ (3 m)

Do not
write
this s

- 8) Xavier and his family had their dinner at Hua Tong Restaurant. The dinner cost \$490. In addition, they had to pay 7% GST and gave \$10 tip to the waitress. How much did they pay for the dinner in total?

Do not
write in
this sp.

Ans: _____ (3 m)

- 9) Amy bought some red, blue and black pens. After she gave 87 blue pens to Patrick and some red and black pens to Richelle, she had 1125 pens left. There were 4 times as many red pens left as blue pens left. The number of black pens left was 108 fewer than the number of red pens left. How many blue pens did Amy buy ?

Ans: _____ (3 m)

- 10) Jenny bought 3 baskets, X, Y and Z. The mass of basket X is $\frac{3}{4}$ that of basket Y. Basket Z is $\frac{1}{2}$ as heavy as basket X. If the mass of basket Y is 51 kg, find the mass of basket Z. Give your answer in kg and g.

Do not
write in
this sp

Ans: _____ (3 m)

- 11) The figure below, not drawn to scale, is made up of a triangle and an octagon with 8 sides, each measuring 13 cm. The base of the triangle is 1.6 times of each side of the octagon. Given that the octagon has an area of 141.8 cm^2 , find the area of the unshaded part.

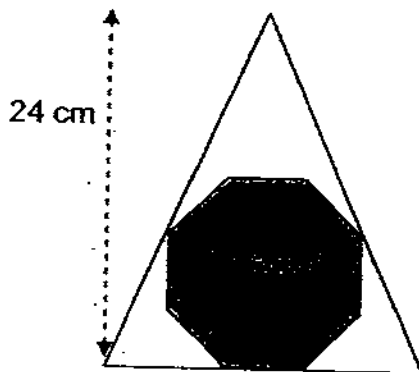

Ans: _____ (3 m)

- 12) Ronald has twice as many ten-dollar notes as fifty-dollar notes. The total value is \$1 260. How many notes does he have in all?

Do not
write
this s

Ans: _____ (4 m)

- 13) In the figure below, not drawn to scale, PQR, SQT, SRW and PSU are straight lines. Given that $\angle RSU$ is twice the size of $\angle TSR$, find $\angle RPS$.

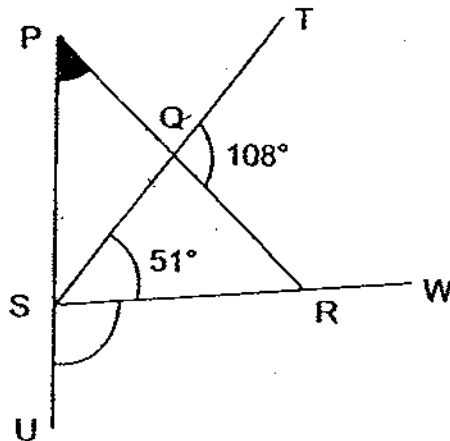

Ans: _____ (4 m)

14) Nordin withdrew 80% of his savings to purchase a laptop. If he were given a 15% discount on the cost price of the laptop, he could have put \$390 back into his savings account.

Do not
write in
this sp

(a) How much did Nordin pay for the laptop?

(b) How much did Nordin have in his savings account at first?

Ans: (a) _____ (2 m)

(b) _____ (2 m)

- 15) The number of \$88, \$128 and \$198 tickets for a concert are in the ratio 9 : 4 : 3. All the tickets for the concert were sold out. The amount collected from the \$128 tickets is \$704 000. What is the total amount of money collected from the concert?

Do
write
this

Ans: _____ (5 m)

- 16) The figure below shows a pattern formed using some plastic sticks.



- (a) How many plastic sticks are used to form 13 squares?
- (b) How many squares are formed using 100 plastic sticks?

Ans: (a) _____ (3m)

(b) _____ (2m)

Do no
write i
this sp

- 17) A vendor bought some eggs from a farm at \$0.22 each. In the process of transporting the eggs to his supermarket, 12 eggs were broken. The remaining eggs were sold at \$0.29 each. In the end, the vendor still earned \$11.50. How many eggs did he buy from the farm?

Do not
write
this :

Ans: _____ (5 m)



18) A frog is at the bottom of a well which is 31 m deep. It climbs 6 m up in the day and slides 4 m down at night.

(a) How many metres has the frog climbed at the end of the 4th night?

(b) How many days does it take for the frog to get out of the well?

Do n
write
this s

Ans: (a) _____ (2m)

(b) _____ (3m)

End Of Paper





ANSWER SHEET

EXAM PAPER 2009

SCHOOL : CHIJ PRIMARY
SUBJECT : PRIMARY 5 MATHEMATICS

TERM : SA2

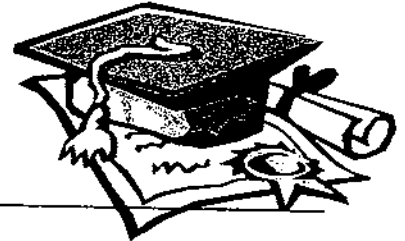

Q1	Q2	Q3	Q4	Q5	Q6	Q7	Q8	Q9	Q10	Q11	Q12	Q13	Q14	Q15
4	2	4	1	4	1	2	4	1	3	2	4	2	3	1

- 16) 8750 17) 2/13 18) 60cm² 19) 5:8 20) \$2.07
21) 0.8km 22) 98 23) 51% 24) 126° 25) \$67.20
26) 9/196 27) 5:24 28) \$44.30 29) \$7.20 30) \$269.64

Paper 2

1) $13.85 + 8.35 = 22.2$ $22.2 \div 15 = \$1.48$	2) $7 + 3 + 4 = 14$ $105 \div 14 = 7.5$ $7.5 \times 3 = 22.5\text{cm}$
3) $1.68 \times 22 = 36.96$ $39.44 - 36.96 = 2.48$ $2.48 \div 2 = 1.24$ $1.24 \times 24 = 29.76$ $39.44 - 29.76 = 9.68$ $9.68 \div 22 = \$0.44$	4) $33 \times 2 = 66$ $66 + 18 = 84$ $328 - 84 = 244$ $244 \div 3 = 81.33$ $81.33 + 18 = 99.33\text{m}$
5) $90 \div 2 = 45$ $35 + 90 = 125$ $180 - 125 = 55$ $180 - 55 = 125$ $125 + 48 = 173$ $180 - 173 = 7$ $90 + 7 = 97$ $45 - 35 = 10$ $45 + 97 = 142$	6) $180 - 128 - 31 = 21^\circ$

<p>7) $\angle y = 180 - 37 - 52 = 91$ $\angle z = 180 - 105 = 75$ $91 - 75 = 16^\circ$</p>	<p>8) $7 / 100 \times 490 / 1 = 34.3$ $34.3 + 490 = 524.3$ $524.30 + 10 = \\$534.3$</p>
<p>9) $1125 + 108 = 1233$ $1233 \div 9 = 137$ $137 + 87 = 224$ blue pen</p>	<p>10) 4 units \rightarrow 51 1 unit \rightarrow 12.75 $\frac{1}{2}$ units $\rightarrow 12.75 \div 2 = 6.375$ $12.75 + 6.375 = 19.125$ $19.125 \text{kg} = 19 \text{kg } 125 \text{g}$</p>
<p>11) base of $\Delta \rightarrow 13 \times 1.6 = 20.8$ Area of $\Delta \rightarrow \frac{1}{2} \times 24 \times 20.8 = 249.6$ unshaded part $\rightarrow 249.6 - 141.8$ $= 107.8 \text{cm}^2$</p>	<p>12) $\\$10 : \\$50 = 2:1$ value of notes: $(\\$10 \times 2) \div \\$50 = \\$70$ $1260 \div 70 = 18$ $18 \times 3 = 54$</p>
<p>13) $51 \times 2 = 102$ $102 + 51 = 153$ $180 - 153 = 27$ $108 + 27 = 135$ $180 - 135 = 45^\circ$</p>	<p>14) a) $\\$2600$ b) $\\$3250$</p>
<p>15) $88 : 128 : 198$ $9 : 4 : 3$</p> <p>$70400 \div 128 = 5500$ $4u \rightarrow 5500$ $1u \rightarrow 1375$ $9u \rightarrow 12375$ $12375 \times 88 = 1089000$ $3u \rightarrow 4125$ $4125 \times 198 = 816750$ $704000 + 1089000 + 816750$ $= 2609750$</p>	<p>16) a) 40 sticks b) $100 - 40 = 60$ $60 \div 3 = 20$ $20 + 13 = 33$ squares</p>
<p>17) $12 \times \\$0.29 = \\3.48 $\\$11.50 + \\$3.48 = \\$14.98$ $\\$0.29 - \\$0.22 = 0.07$ $\\$14.98 + 0.07 = \\214</p>	<p>18) a) 8m b) 32 day</p>