



PEI HWA PRESBYTERIAN PRIMARY SCHOOL
SEMESTRAL ASSESSMENT 1

PRIMARY 5
MATHEMATICS PAPER 1
(BOOKLET A)

11 MAY 2016

Name : _____

Form Class / Register No. : 5L _____ / _____

Banded Class / Register No. : 5M _____ / _____

Total time for Booklets A and B: 50min

INSTRUCTIONS TO CANDIDATES

1. Write your Name, Class and Register No. in the spaces provided above.
2. DO NOT turn over this page until you are told to do so.
3. Follow all instructions carefully.
4. Answer all questions.
5. Shade your answers on the Optical Answer Sheet (OAS) provided.
6. The use of calculator is **NOT ALLOWED**.

This booklet consists of printed pages, excluding the cover page.

Paper 1 (Booklet A)

Questions 1 to 10 carry 1 mark each. Questions 11 to 15 carry 2 marks each. For each question, four options are given. One of them is the correct answer. Make your choice (1, 2, 3 or 4). Shade the oval (1, 2, 3 or 4) on the Optical Answer Sheet. You are not allowed to use a calculator. (20 marks)

- 1 Nine million, three hundred thousand and seven is _____.
- (1) 900 307
(2) 930 007
(3) 9 000 307
(4) 9 300 007 ()
- 2 What is the value of $5\,000 \times 80$?
- (1) 4000
(2) 40 000
(3) 400 000
(4) 4 000 000 ()
- 3 Express $2\frac{5}{9}$ as a decimal. Round off your answer to 2 decimal places.
- (1) 0.55
(2) 0.56
(3) 2.55
(4) 2.56 ()

4 Find the sum of $\frac{1}{5}$ and $\frac{1}{6}$.

(1) $\frac{1}{11}$

(2) $\frac{2}{11}$

(3) $\frac{1}{30}$

(4) $\frac{11}{30}$

()

5 What is the product of $\frac{5}{6}$ and $\frac{2}{3}$?

(1) $\frac{7}{18}$

(2) $\frac{5}{9}$

(3) $\frac{7}{9}$

(4) $1\frac{1}{9}$

()

6 Find the value of $\frac{9}{4} \div 5$.

(1) $\frac{4}{45}$

(2) $\frac{9}{20}$

(3) $2\frac{2}{9}$

(4) $11\frac{1}{4}$

()

7 Find the area of the triangle.

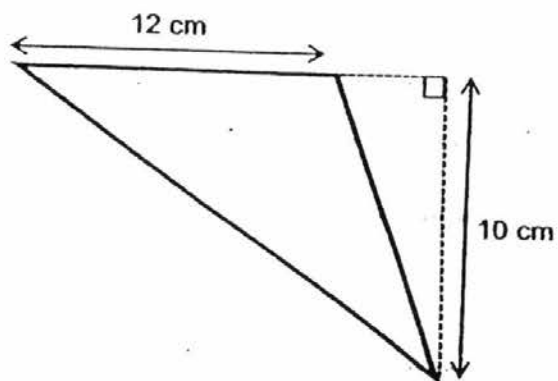

(1) 60 cm^2

(2) 90 cm^2

(3) 120 cm^2

(4) 180 cm^2

()

8

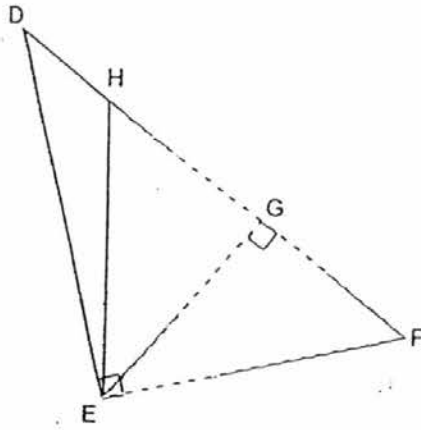

Name the height of Triangle DEH if DH is the base.

- (1) DE
- (2) EF
- (3) EG
- (4) EH

()

9 $4 : 7 = 28 : \boxed{?}$. What is the missing number in the box?

- (1) 7
- (2) 31
- (3) 49
- (4) 56

()

10 June baked twice as many cookies as Claire. Claire baked twice as many cookies as Sunny. What is the ratio of the number of ~~tarts~~ baked by June to the number of ~~tarts~~ baked by Sunny?
cookies cookies

(1) 1 : 4

(2) 1 : 8

(3) 4 : 1

(4) 8 : 1

()

11 270 000 visitors went to an IT fair when rounded off to the nearest thousand. Which could be the possible number of visitors?

(1) 269 099

(2) 269 971

(3) 270 500

(4) 270 909

()

12 Find the value of $25 + 5 \times 5 + (76 - 20 + 40)$.

(1) 17

(2) 41

(3) 97

(4) 121

()

13 John gave $\frac{1}{8}$ of his salary to each of his two parents. He gave $\frac{1}{3}$ of the remainder to his son. What fraction of his salary had he left?

(1) $\frac{1}{2}$

(2) $\frac{7}{8}$

(3) $\frac{7}{24}$

(4) $\frac{13}{24}$

()

14 There are 16 sweets and 32 chocolates in a basket. What is the ratio of the number of chocolates to the total number of sweets and chocolates?

(1) 1 : 3

(2) 2 : 3

(3) 3 : 1

(4) 3 : 2

()

15 ABCD is a square. What is the area of the shaded part?

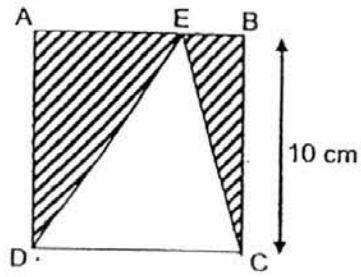

- (1) 20 cm^2
- (2) 40 cm^2
- (3) 50 cm^2
- (4) 100 cm^2

()

-- End of Booklet A --



PEI HWA PRESBYTERIAN PRIMARY SCHOOL
SEMESTRAL ASSESSMENT 1

PRIMARY 5
MATHEMATICS PAPER 1
(BOOKLET B)

11 MAY 2016

Name : _____

Parent's signature

Form Class / Register No. : 5L _____ / _____

Banded Class / Register No. : 5M _____ / _____

Total time for Booklets A and B: 50min

INSTRUCTIONS TO CANDIDATES

1. Write your Name, Class and Register No. in the spaces provided above.
2. DO NOT turn over this page until you are told to do so.
3. Follow all instructions carefully.
4. Answer all questions.
5. Write all your answers in this booklet.
6. The use of calculator is **NOT ALLOWED**.

Marks (Booklet A) :	20
Marks (Booklet B) :	20
Total Marks (Booklets A and B) :	40

This booklet consists of 7 printed pages, excluding the cover page.

Questions 16 to 25 carry 1 mark each. Write your answers in the spaces provided. For questions which require units, give your answers in the units stated. (10 marks)

Do not write in this space.

16 In 4 500 207, what is the value of the digit 5?

Ans: _____

17 $500\ 000 \div \text{_____} = 500$

What is the missing number in the blank?

Ans: _____

18 If 200 g of salmon cost \$6, how much will 2 kg of salmon cost?

Ans: \$ _____

19 Find the value of $\frac{7}{9} - \frac{2}{3}$.

Ans: _____

- 20 Andy had 56 sweets. He gave $\frac{2}{7}$ of them to Bella. How many sweets had Andy left?

Do not write
in this
space.

Ans: _____

- 21 Belinda had $\frac{4}{5}$ kg of sugar. She then packed the sugar equally into 8 packets. What was the mass of each packet of sugar?

Ans: _____ kg

22 Find the area of triangle ABC.

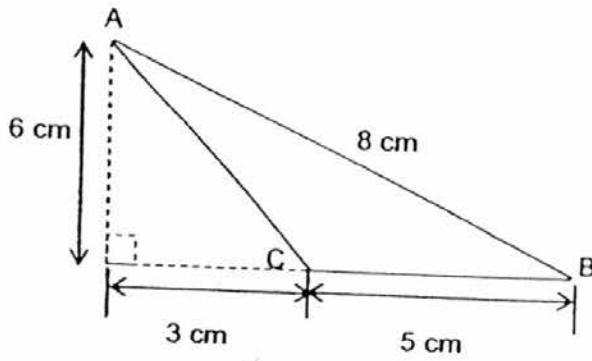

Do not write
in this
space.

Ans: _____ cm²

23 Use a set-square to draw and label the height of the triangle for the given base.

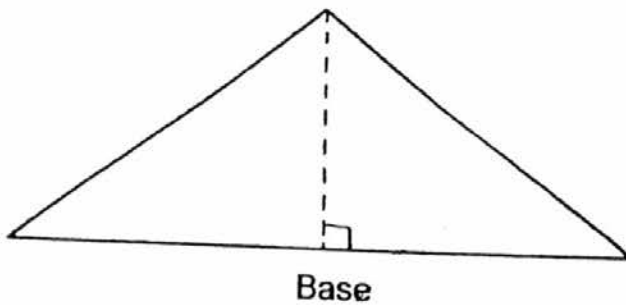

24 Given that $A : B = 4 : 3$ and $B : C = 2 : 5$, find $A : C$.

Do not write
in this
space.

Ans: _____

25 Write the ratio $45 : 63 : 72$ in its simplest form.

Ans: _____

Questions 26 to 30 carry 2 marks each. Show your working clearly and write your answers in the spaces provided. For questions which require units, give your answers in the units stated. (10 marks)

Do not write in this space.

- 26 A sling bag costs \$6 more than a water bottle. If the total cost of the sling bag and 2 such water bottles is \$27, find the cost of 5 such water bottles.

Ans: \$ _____

- 27 The breadth of a rectangular soccer field is $\frac{1}{3}$ its length. The perimeter of the soccer field is 420 m. Find the breadth of the soccer field.

Ans: _____ m

- 28 George and Michael had a total of \$428. After George saved another \$52 and Michael spent $\frac{1}{3}$ of his money, they both had the same amount of money. How much money did George have at first?

Do not write in this space.

Ans: \$ _____

29

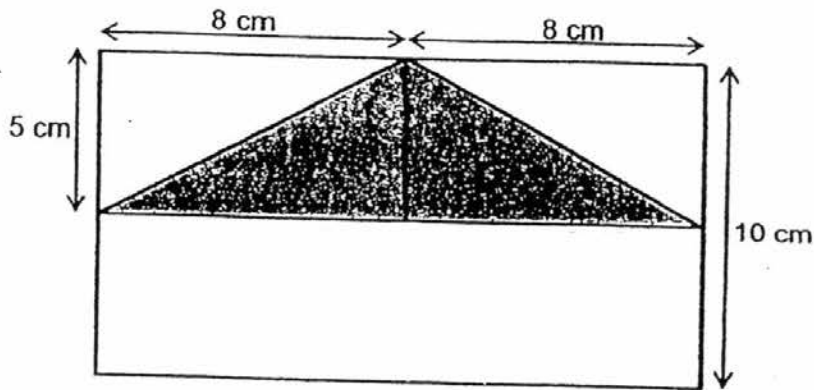

What fraction of the figure above is unshaded? (Leave your answer in its simplest form.)

Ans: _____

- 30 There are some red, blue and yellow balls in a box. The ratio of the number of red to the number of blue balls is $2 : 3$. The number of blue to the number of yellow balls is $6 : 7$. There are 16 more blue than red balls. How many red balls are there?

Do not write
in this
space.

Ans: _____



END OF PAPER 1



PEI HWA PRESBYTERIAN PRIMARY SCHOOL
SEMESTRAL ASSESSMENT 1

PRIMARY 5
MATHEMATICS
PAPER 2

11 MAY 2016

Name : _____

Parent's signature

Form Class / Register No. : 5L _____ / _____

Banded Class / Register No. : 5M _____ / _____

Total time: 1h 40min

INSTRUCTIONS TO CANDIDATES

1. Write your Name, Class and Register No. in the spaces provided above.
2. DO NOT turn over this page until you are told to do so.
3. Follow all instructions carefully.
4. Answer all questions.
5. Write all your answers in this booklet.
6. The use of an approved calculator is expected, where appropriate.

Paper 1 :	40
Paper 2 :	60
Total Marks :	100

This booklet consists of 14 printed pages, excluding the cover page.

Questions 1 to 5 carry 2 marks each. Show your working clearly and write your answers in the spaces provided. For questions which require units, give your answer in the units stated. (10 marks)

Do not write in this space

- 1 Paul and Jane have some picture cards. After Paul has given 36 picture cards to Jane, he has 24 picture cards more than her. How many more picture cards than Jane does Paul have at the beginning?

Ans: _____

- 2 The parking charges at MEX Shopping Mall are as follows:

For the 1 st hour	\$3
For every subsequent half hour or part thereof	\$1.20

John parked his car for 3 hours.

How much did he pay for the parking charges?

Ans: \$ _____

- 3 If $\frac{1}{3}$ of a number is 25, what is $\frac{2}{5}$ of the number?

Do not write in
this space

Ans. _____

- 4 The figure below is made up of 2 triangles, ABC and ACD.
The length of AD is thrice as much as the length of BC. AB is
perpendicular to AD and BC. Find the area of figure ABCD.

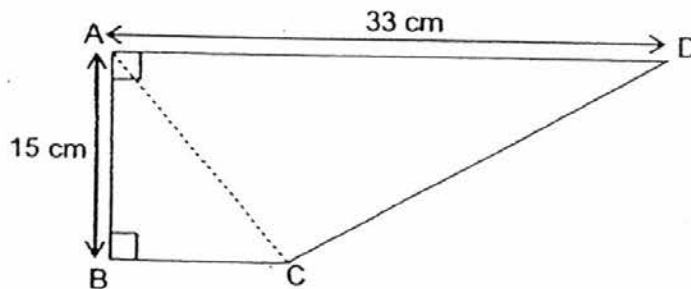

Ans: _____ cm²

- 5 The ratio of Brenda's money to Claire's money is 2 : 9. They have \$385 in total. How much money must Claire give Brenda so that each of them has an equal amount of money?

Do not write in this space

Ans: \$ _____

Questions 6 to 18 show your working clearly and write your answers in the spaces provided. The number of marks available is shown in brackets [] at the end of each question or part question. (50 marks)

Do not write in this space

- 6 In Old MacDonald's farm, there are three times as many chickens as sheep. Given that there are 300 legs altogether, how many chickens are there in the farm?

Ans: _____ [3]

- 7 For every \$15 Andre saved, his father would give him \$2.50. If he saved a total of \$345 by himself after some months, how much would he have received from his father?

Ans: _____ [3]

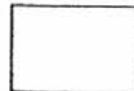

- 8 Mrs Wong spent $\frac{3}{7}$ of her salary on food and $\frac{3}{4}$ of the remainder on other daily expenses. What fraction of her salary was left?

Do not write in this space

Ans: _____ [3]

- 9 The figure below is made up of two shaded triangles within a rectangle. Find the area of the unshaded part.

Do not write in this space

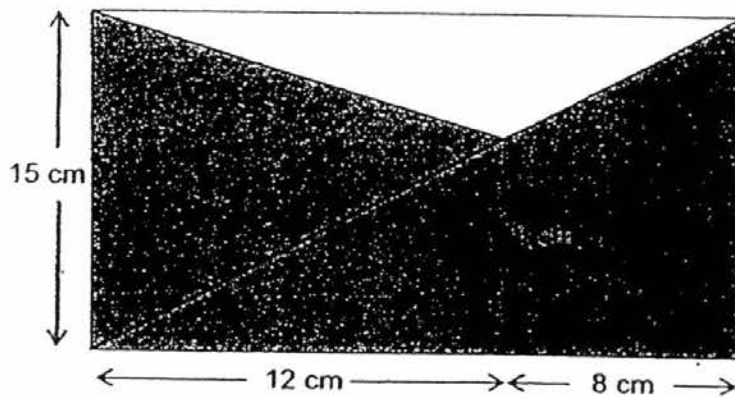

Ans: _____ [3]

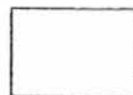

- 10 Last Sunday, the ratio of the number of boys to the number of girls at the circus was 3 : 5. There are 148 fewer boys than girl. How many children were at the circus?

Do not write in this space

Ans: _____ [3]

- 11 Mrs Billy made 248 more white chocolate cookies than dark chocolate cookies. After she gave away $\frac{5}{7}$ of the white chocolate cookies and $\frac{1}{3}$ of the dark chocolate cookies, there were an equal number of white chocolate cookies and dark chocolate cookies left. How many white chocolate cookies did she give away?

Ans: _____ [3]

- 12 A sum of \$728 is divided among a group of people. $\frac{7}{8}$ of the people receive \$4 each, $\frac{1}{3}$ of the remainder receive \$3 each and the rest receive \$2 each. How many people are there altogether?

Do not write in this space

Ans: _____ [4]

- 13 ABFG is a square. The length of CD is $\frac{3}{5}$ of BF and the area of BCDE is 864 cm². Given BC = EF, find the area of the shaded parts.

Do not write in this space

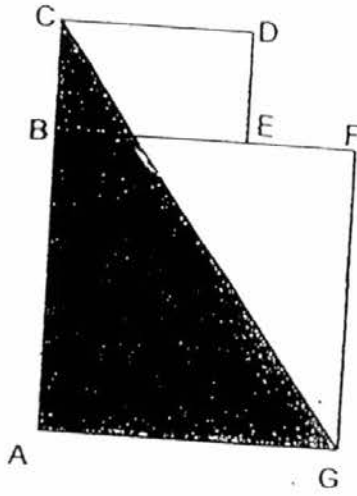

Ans: _____ [4]

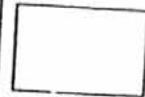

- 14 The number of balls in Box A was 38 more than that in Box B. When Belicia removed 61 balls from Box A and placed them in Box B, the ratio of the number of balls in Box A to the number of balls in Box B became 1 : 4. Find the number of balls in each box at first.

Do not write in this space

Ans: Box A: _____ [2]

Box B: _____ [2]

15 Study the pattern below. The figures are made up of black diamonds. Each black diamond is denoted by . Do not write in this space

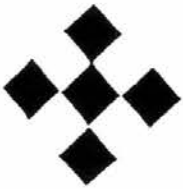

Figure 1

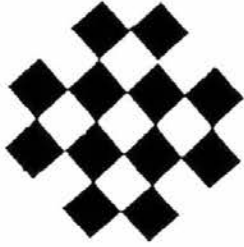

Figure 2

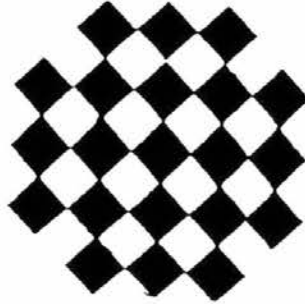

Figure 3

- (a) How many black diamonds will there be in Figure 4?
- (b) How many black diamonds will there be in Figure 10?
- (c) Which figure is made up of 396 black diamonds?

Answer: (a) _____ [2]
 (b) _____ [2]
 (c) Figure _____ [1]



16 Timmy's monthly salary was \$4200. Every month, he would give $\frac{3}{10}$ of his salary to his parents and pay \$850 for his car loan. He would also spend $\frac{2}{5}$ of the remaining money on food and save the rest. What fraction of his monthly salary did he spend on his car loan and food?
(Leave your answer in its simplest form.)

Do not write
in this space

Ans: _____ [5]



- 17 Benny painted a letter 'N' on a piece of rectangular cardboard that has a length of 15 cm. The ratio of the length to the breadth of the cardboard is 5:4. Both triangles were identical. What area of the cardboard was painted?

Do not write
in this space

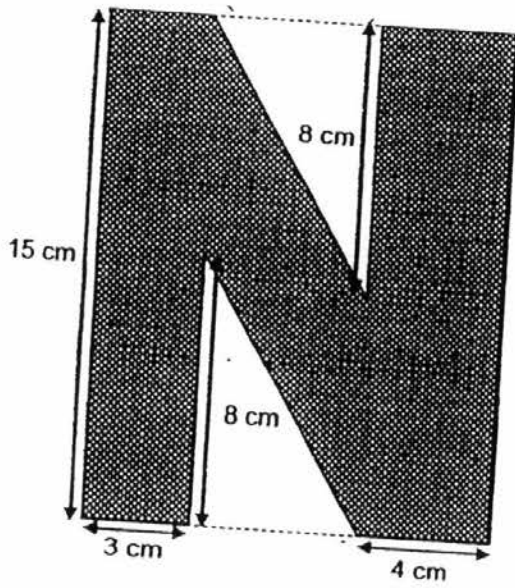

Ans: _____ [5]



- 18 The ratio of the number of chickens in Farm A to the number of chickens in Farm B was 5 : 9. There were 48 fewer chickens in Farm A than in Farm B. When 5 chickens escaped from Farm B, the farmer in Farm B bought another 9 chickens. What was the new ratio of the number of chickens in Farm A to the number of chickens in Farm B? Give your answer in the simplest form.

Do not write
in this space

Ans: _____ [5]

- End of Paper 2 -

YEAR : 2016
 LEVEL : PRIMARY 5
 SCHOOL : PEI HWA PRESBYTERIAN PRIMARY
 SUBJECT : MATHEMATICS
 TERM : SA1

Paper 1

Q1	4	Q4	4	Q7	1	Q10	3	Q13	1
Q2	3	Q5	2	Q8	3	Q11	2	Q14	2
Q3	4	Q6	2	Q9	3	Q12	4	Q15	3

Q16 500 000

Q17 1000

Q18 \$60

Q19 $\frac{1}{9}$

Q20 $7u \rightarrow 56$
 $1u \rightarrow 56 \div 7 = 8$
 $2u \rightarrow 8 \times 2 = 16$
 $56 - 16 \Rightarrow \underline{40 \text{ sweets left}}$

Q21 $\frac{4}{5} + \frac{8}{1} = \frac{4}{5} \times \frac{1}{8} \Rightarrow \frac{1}{10} \text{ kg}$

Q22 $\frac{1}{2} \times 5 \times 6 \Rightarrow \underline{15 \text{ cm}^2}$

Q23

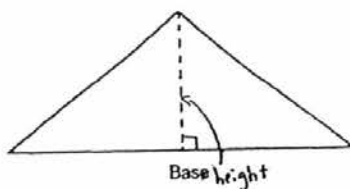

Q24 8 : 15

Q25 5 : 7 : 8

Q26 $3u \rightarrow 27 - 6 = 21$
 $1u \rightarrow 21 \div 3 = 7$
 $5u \rightarrow 7 \times 5 \Rightarrow \underline{\$35}$

Q27 $8u \rightarrow 420$
 $1u \rightarrow 420 \div 8 \Rightarrow \underline{52.50 \text{ m}}$

Q28 $5u \rightarrow 428 + 52 = 480$
 $1u \rightarrow 480 \div 5 = 96$
 $2u \rightarrow 96 \times 2 = 192$
 $192 - 52 \Rightarrow \underline{\$140}$

Q29 $\frac{3}{4}$

Q30 $6u - 4u = 2u$
 $2u \rightarrow 16$
 $1u \rightarrow 16 \div 2 = 8$
 $4u \rightarrow 8 \times 4 \Rightarrow \underline{32}$

Paper 2

Q1 $36 + 24 + 36 \Rightarrow \underline{96 \text{ cards}}$

Q2 First hour $\rightarrow \$3$
One hour $\rightarrow \$1.20 \times 2 = \2.40
One hour $\rightarrow \$1.20 \times 2 = \2.40
Total $\rightarrow \$3 + \$2.40 + \$2.40 \Rightarrow \underline{\$7.80}$

Q3 $5u \rightarrow 25$
 $1u \rightarrow 25 \div 5 = 5$
 $6u \rightarrow 5 \times 6 \Rightarrow \underline{30}$

Q4 AD $\rightarrow 33$
BC $\rightarrow 33 \div 3 = 11$
Area of ABC $\rightarrow \frac{1}{2} \times 15 \times 11 = 82.50$
Area of ACD $\rightarrow \frac{1}{2} \times 15 \times 33 = 247.50$
Total area $\rightarrow 247.50 + 82.50 \Rightarrow \underline{330 \text{ cm}^2}$

Q5 $2u + 9u = 11u$
 $11u \rightarrow 385$
 $1u \rightarrow 385 \div 11 = 35$
 $11 \div 2 = 5.5$
 $9u - 5.5u = 3.5u$
 $3.5u \rightarrow 35 \times 3.5 \Rightarrow \underline{\$122.50}$

- Q6 $10u \rightarrow 300$
 $1u \rightarrow 300 \div 10 = 30$
 $3u \rightarrow 30 \times 3 \Rightarrow \underline{90 \text{ chickens}}$
- Q7 $345 \div 15 = 23$
 $23 \times 2.50 \Rightarrow \underline{\$57.50}$
- Q8 $\frac{1}{7}$
- Q9 60 cm^2
- Q10 $5u - 3u = 2u$
 $2u \rightarrow 148$
 $1u \rightarrow 148 \div 2 = 74$
 $8u \rightarrow 74 \times 8 \Rightarrow \underline{592 \text{ children}}$
- Q11 $\frac{2}{7}$ of White $\rightarrow \frac{2}{3}$ of Dark
 $7u - 3u = 4u$
 $4u \rightarrow 248$
 $1u \rightarrow 248 \div 4 = 62$
 $5u \rightarrow 62 \times 5 \Rightarrow \underline{310 \text{ white chocolate cookies}}$
- Q12 1 set $\rightarrow 24$ people
 $21 \times \$4 + \$3 + \$2 + \$2 = \$91$
 $728 \div 91 = 8$ no. of sets
 $24 \times 8 \Rightarrow \underline{192 \text{ people}}$
- Q13 $3 : 2 = 36 : 24$
 $\frac{1}{2} \times 60 \times 84 \Rightarrow \underline{2520 \text{ cm}^2}$
- Q14 $3u \rightarrow 23 + 38 + 23 = 84$
 $1u \rightarrow 84 \div 3 = 28$
 Box A $\rightarrow 28 + 61 \Rightarrow \underline{89 \text{ balls}}$
 Box B $\rightarrow 28 + 23 \Rightarrow \underline{51 \text{ balls}}$
- Q15a 32 diamonds
- Q15b 140 diamonds
- Q15c Figure 18

Q16 $4200 + 10 = 420$
 $420 \times 3 = 1260$
 $1260 + 850 = 2110$
 $4200 - 2110 = 2090$
 $2090 + 5 = 418$
 $418 \times 2 = 836$
 $850 + 836 = 1686$
 $\frac{1686}{4200} \Rightarrow \frac{281}{700}$

Q17 $5u \rightarrow 15$
 $1u \rightarrow 15 + 5 = 3$
Breadth $\rightarrow 3 \times 4 = 12$
Area of 1 triangle $\rightarrow \frac{1}{2} \times 8 \times 5 = 20$
Area of 2 triangles $\rightarrow 20 \times 2 = 40$
Area of whole figure $\rightarrow 15 \times 12 = 180$
Painted $\rightarrow 180 - 40 \Rightarrow \underline{140 \text{ cm}^2}$

Q18 $4u \rightarrow 48$
 $1u \rightarrow 48 + 4 = 12$
 $9u \rightarrow 12 \times 9 = 108$
 $108 - 5 = 103$
 $103 + 9 = 112$
 $5u \rightarrow 12 \times 5 = 60$
 $60 : 112$
 $30 : 56$
 $15 : 28$

End