



Rosyth School  
First Continual Assessment 2016  
Primary 5 Mathematics

Name: \_\_\_\_\_ Register No. \_\_\_\_\_

Class: Pr 5 - \_\_\_\_\_

Date: 26<sup>th</sup> February 2016 Parent's Signature: \_\_\_\_\_

Total Time for Booklets A and B : 50 minutes

---

**PAPER 1  
(Booklet A)**

Instructions to Pupils:

1. Do not open this booklet until you are told to do so.
2. Follow all instructions carefully.
3. Shade your answers in the Optical Answer Sheet (OAS) provided.
4. You are **not** allowed to use a calculator
5. Answer all questions.

Section	Maximum Mark	Marks Obtained
Paper.1 (Booklet A)	20	

**\* This booklet consists of 6 printed pages (including this cover page)**

This paper is not to be reproduced in part or whole without the permission of the Principal.

Questions 1 to 10 carry 1 mark each. Questions 11 to 15 carry 2 marks each. For each question, four options are given. One of them is the correct answer. Make your choice (1, 2, 3 or 4). Shade the oval (1, 2, 3 or 4) on the Optical Answer Sheet.

*All diagrams in this paper are not drawn to scale unless stated otherwise.*

(20 marks)

1. Which of the numbers below has the digit '4' in the ten thousands place?

- (1) 148 302
- (2) 301 842
- (3) 483 012
- (4) 814 230

2. 1 million, 65 thousands, 8 tens and 9 ones is \_\_\_\_\_.

- (1) 1 065 089
- (2) 1 065 890
- (3) 1 650 089
- (4) 1 650 809

3. Which one of the following has the same value as  $57 - 7 \times 6 \div 3$ ?

- (1) 5
- (2) 43
- (3) 72
- (4) 100

4. Which one of the following number statements does not have a value of 72 000?

- (1)  $4 \times 18\ 000$
- (2)  $24 \times 3000$
- (3)  $360 \times 200$
- (4)  $900 \times 800$

5. What is the value of  $315\,000 \div 300$ ?

- (1) 105
- (2) 150
- (3) 1050
- (4) 1500

6.  $10\frac{66}{1000}$  expressed as a decimal is \_\_\_\_\_.

- (1) 10.066
- (2) 10.606
- (3) 10.660
- (4) 10.666

7. 4 hundreds, 4 ones and 40 thousandths is \_\_\_\_\_.

- (1) 400.404
- (2) 400.440
- (3) 404.040
- (4) 404.400

8. The value of  $78 - 15 \div 3 + 4 \times 6$  is \_\_\_\_\_.

- (1) 24
- (2) 49
- (3) 97
- (4) 150

9. Which of the following are pairs of parallel lines?

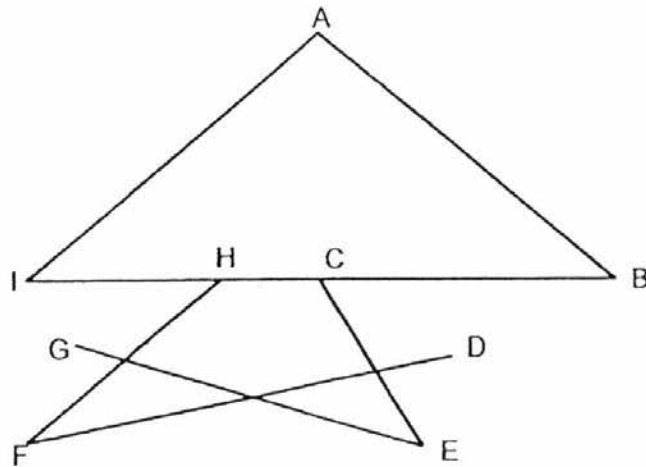

- (1)  $AB \parallel CE$
- (2)  $AB \parallel GE$
- (3)  $AI \parallel DF$
- (4)  $AI \parallel HF$

10. Which of the following shapes can be tessellated?

(A)



(B)

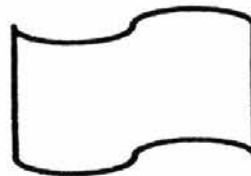

(C)

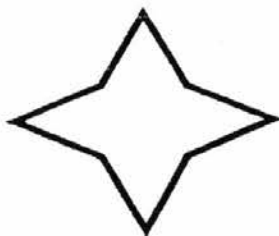

(D)



- (1) A only
- (2) A and B
- (3) B and C
- (4) C and D

11. What is the total area of the 2 squares below?

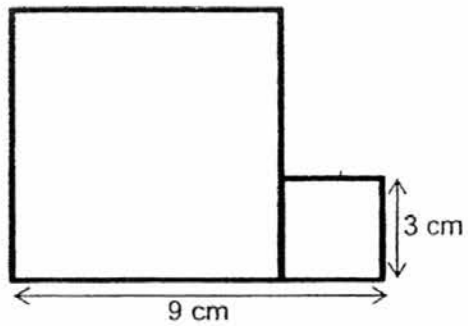

- (1)  $27 \text{ cm}^2$
- (2)  $36 \text{ cm}^2$
- (3)  $45 \text{ cm}^2$
- (4)  $81 \text{ cm}^2$

12. A farmer had 65 oranges. He packed them into bags of 6 each. How many oranges were not packed?

- (1) 5
- (2) 6
- (3) 10
- (4) 11

13. Keith had \$262. He paid \$26 for a shirt and spent 3 times as much on a pair of shoes. How much money had he left?

- (1) \$78
- (2) \$104
- (3) \$158
- (4) \$184

14. The length of a blue ribbon is 23.094 m. It is 0.17 m longer than the length of a red ribbon. What is the length of the red ribbon?

- (1) 22.924 m
- (2) 23.077 m
- (3) 23.124 m
- (4) 23.264 m

15. Mrs Lee spent \$17.35 at the supermarket. Mdm Pasu spent 6 times as much as Mrs Lee. How much more did Mdm Pasu spend than Mrs Lee?

- (1) \$69.40
- (2) \$86.75
- (3) \$104.10
- (4) \$121.45



Rosyth School  
First Continual Assessment 2016  
Primary 5 Mathematics

Name: \_\_\_\_\_ Register No. \_\_\_\_\_

Class: Pr 5 - \_\_\_\_\_

Date: 26<sup>th</sup> February 2016 Parent's Signature: \_\_\_\_\_

Total Time for Booklets A and B : 50 minutes

---

**PAPER 1**  
**(Booklet B)**

Instructions to Pupils:

1. Do not open this booklet until you are told to do so.
2. Follow all instructions carefully.
3. You are **not** allowed to use a calculator.
4. Answer all questions.

Section	Maximum Mark	Marks Obtained
Paper 1 (Booklet B)	20	

**\* This booklet consists of 7 printed pages (including this cover page)**

This paper is not to be reproduced in part or whole without the permission of the Principal.

Questions 16 to 25 carry 1 mark each. Write your answers in the spaces provided. For questions which require units, give your answers in the units stated. (10 marks)

Do not write in this space

*All diagrams in this paper are not drawn to scale unless stated otherwise.*

16. Arrange the following numbers from the greatest to the smallest number. 53 001, 53 100, 53 101 and 53 010

Ans: \_\_\_\_\_ , \_\_\_\_\_ , \_\_\_\_\_ , \_\_\_\_\_  
greatest

17. The price of a car when rounded off to the nearest \$1 000 is \$90 000. What is the greatest possible price of the car?

Ans: \$ \_\_\_\_\_

18. Find the value of  $76 - 56 \div (4 + 3) \times 4$ .

Ans: \_\_\_\_\_

19. Find the value of  $840 \div 6$ .

Ans: \_\_\_\_\_



20. 49.985 when rounded off to 2 decimal places is \_\_\_\_\_.

Do not write  
in this space

Ans: \_\_\_\_\_

21. Fill in the missing number.  
23.66, \_\_\_\_\_, 23.72, 23.75, 23.78

Ans: \_\_\_\_\_

22. The area of a square is  $81 \text{ cm}^2$ . Find the perimeter of the figure.

Ans: \_\_\_\_\_ cm

23. Line PQ is the line of symmetry. Shade 2 squares to make the figure below symmetrical.

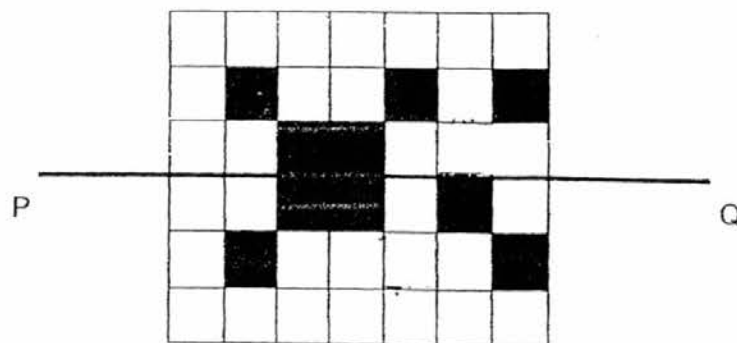

24. Using a set-square, draw a line perpendicular to line AB through Point O.

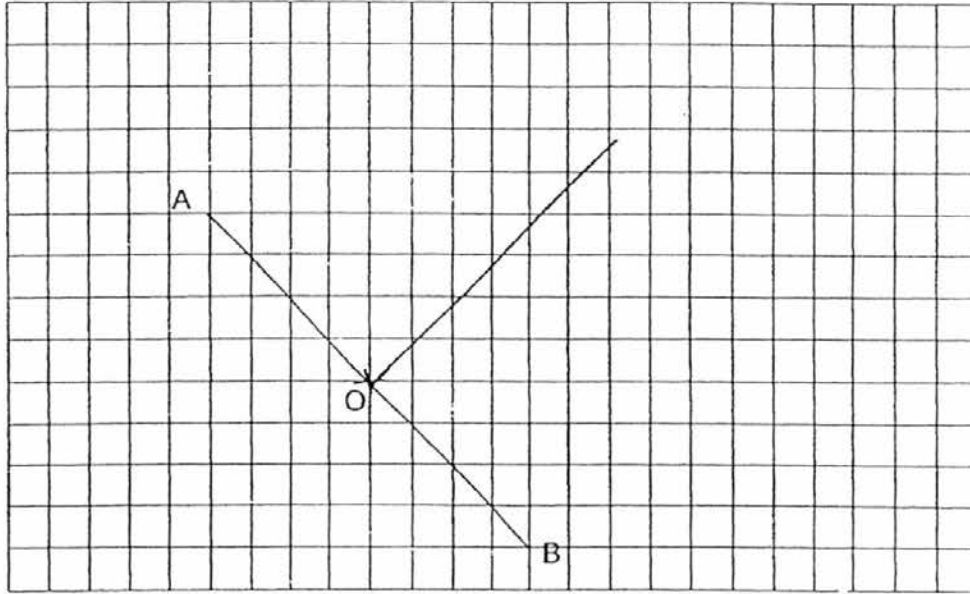

Do not write  
in this space

25. There are 40 pupils in a class. The pupils are divided into groups consisting of 3 boys and 5 girls in each group. How many boys are there in the class?

Ans: \_\_\_\_\_

Questions 26 to 30 carry 2 marks each. Show your workings clearly in the space provided for each question and write your answers in the spaces provided. For questions which require units, give your answers in the units stated.

Do not write in this space

(10 marks)

**All diagrams in this paper are not drawn to scale unless stated otherwise.**

26. A cycling track is 5.9 km long. Roy cycled 6 complete rounds. Joe cycled 9.9 km less than Roy. How far did Joe cycle?

Ans: \_\_\_\_\_ km

27. Extend the tessellation by drawing 2 more unit shapes in the space provided within the dot diagram.

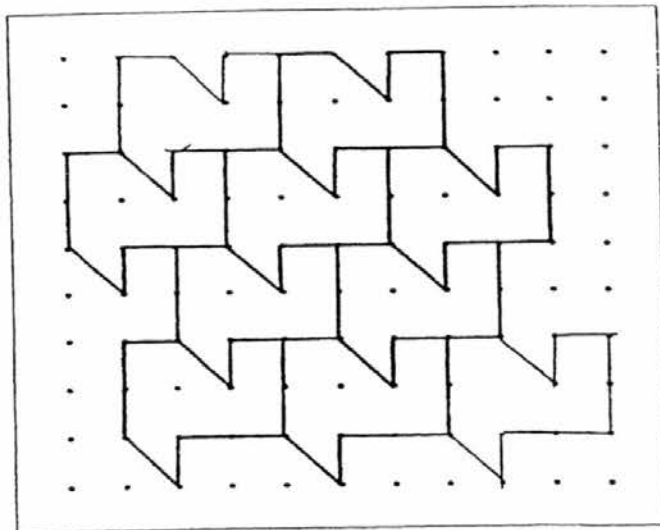

28. The graph below shows the number of story books Mr Ahmad sold for 4 days.

Do not write  
in this space

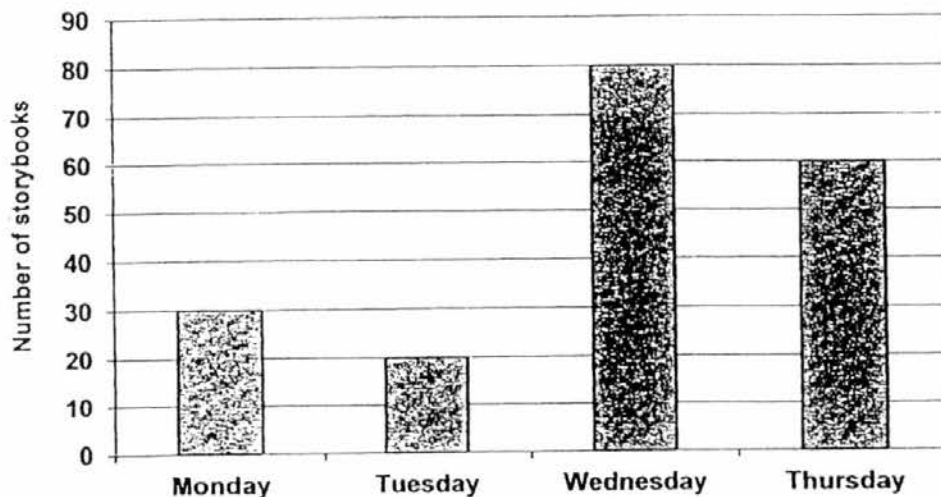

What was the total number of books sold from Monday to Thursday?

Ans: \_\_\_\_\_

29. A square of side 5 cm has been cut out from a rectangular piece of paper as shown below. Only 14 such squares can be cut out exactly from the paper. Find the perimeter of the rectangular piece of paper.

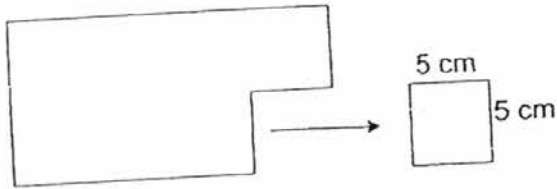

Do not write in this space

Ans: \_\_\_\_\_ cm



30. The figure below is made up of identical rectangles. Find the area of the shaded rectangle.

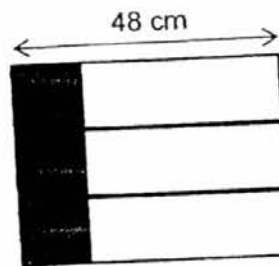

Ans: \_\_\_\_\_ cm<sup>2</sup>



End of paper.



Rosyth School  
First Continual Assessment 2016  
Primary 5 Mathematics

Name: \_\_\_\_\_ Register No. \_\_\_\_\_

Class: Pr 5 - \_\_\_\_\_

Date: 26<sup>th</sup> February 2016 Parent's Signature: \_\_\_\_\_

Time: 1h 15min

---

**PAPER 2**

Instructions to Pupils:

1. Do not open this booklet until you are told to do so.
2. Follow all instructions carefully.
3. **Show your workings clearly** as marks are awarded for correct working.
4. Write your answers in this booklet.
5. You are allowed to use a calculator.
6. Answer all questions.

Questions	Maximum Mark	Marks Obtained
Q 1 to 5	10	
Q 6 to 13	30	

Section	Maximum Mark	Marks Obtained
Paper 1	40	
Paper 2	40	
Total	80	

\* This booklet consists of 12 printed pages (including this cover page)

This paper is not to be reproduced in part or whole without the permission of the Principal.

Questions 1 to 5 carry 2 marks each. Show your working clearly in the space provided for each question and write your answers in the spaces provided. For questions which require units, give your answers in the units stated.

(10 marks)

Do not write  
in this space

*All diagrams in this paper are not drawn to scale unless stated otherwise.*

1. 1 is a factor of 35 and 14. What is another factor of 35 and 14?

Ans: \_\_\_\_\_

2. Write down the first 3 common multiples of 4 and 8.

Ans: \_\_\_\_\_, \_\_\_\_\_, \_\_\_\_\_

3. The mass of a basketball is 450 g. It is 6.8 kg lighter than a bowling ball. What is the mass of the bowling ball in kilograms?

Ans: \_\_\_\_\_ kg

4. The graph below shows the number of books borrowed by 40 pupils in a class.

Do not write in this space

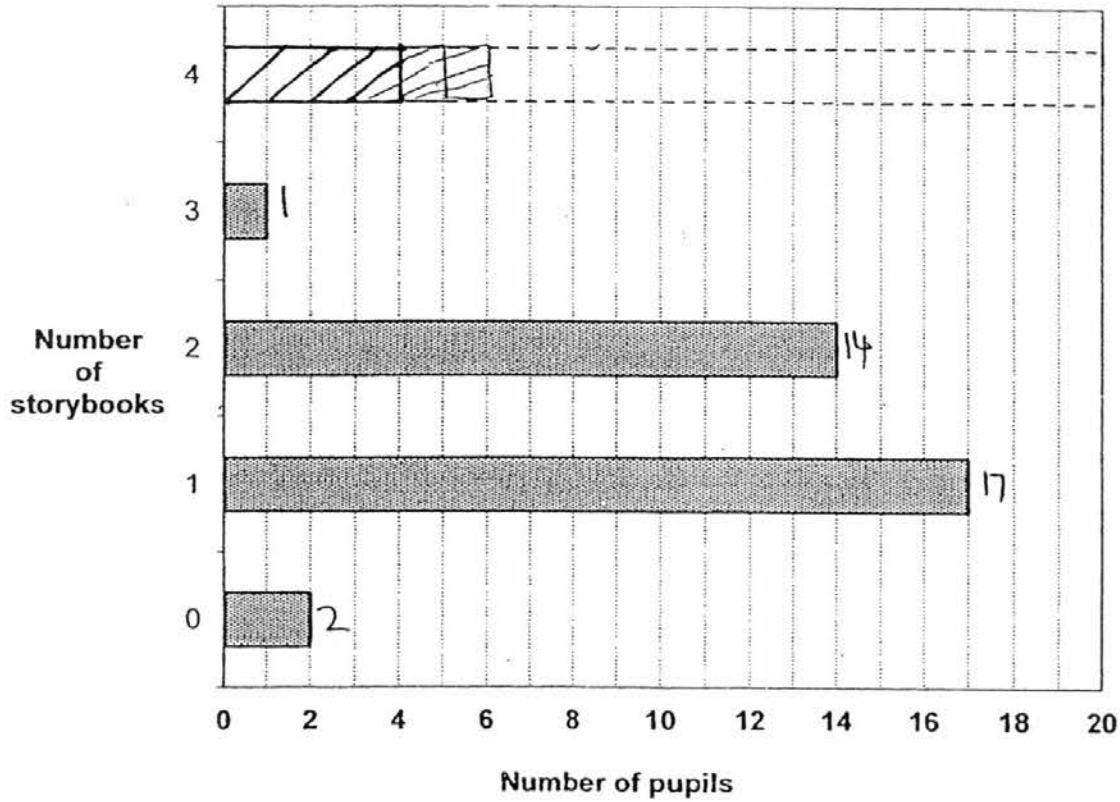

Draw the bar representing the number of pupils who <sup>Borrowed</sup> read 4 storybooks. You are not required to shade the bar.





5. Willy bought a laptop for \$2 588. He paid \$860 in cash at first.  
He paid the remainder in 12 months.  
He paid an equal amount of money each month.  
How much did Willy pay each month?

Do not write  
in this space

Ans: \$ \_\_\_\_\_

For Questions 6 to 13, show your working clearly in the space provided for each question and write your answers in the spaces provided. The number of marks available is shown in brackets [ ] at the end of each question or part-question. For questions which require units, give your answers in the units stated.

Do not write  
in this space

**All diagrams in this paper are not drawn to scale unless stated otherwise.**  
(30 marks)

6. Jose spent \$8.80 to buy 13 pens and 6 erasers.  
The cost of 3 pens is the same as 2 erasers.  
What is the cost of 1 pen?

Ans: \_\_\_\_\_ [3]

7. The figure below shows a rectangular field which measures 80 m by 46 m. There is a 2 m wide footpath surrounding the field. Find the area of the footpath.

Do not write  
in this space

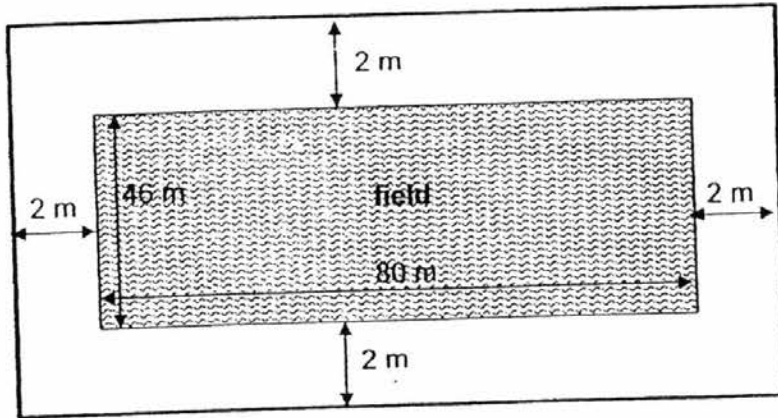

Ans: \_\_\_\_\_ [3]

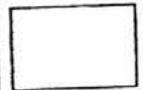

8. Mrs Gomesh gave some sweets to her pupils.  
If she gave each pupil 7 sweets, she would need 4 more sweets.  
If she gave each pupil 5 sweets, there would be 4 sweets left.  
How many pupils were there altogether?

Do not write  
in this space

Ans: \_\_\_\_\_ [3]

9. Uncle Frank sold 4 different coloured pens. The line graph below shows the number of pens sold for each colour in a week.

Do not write in this space

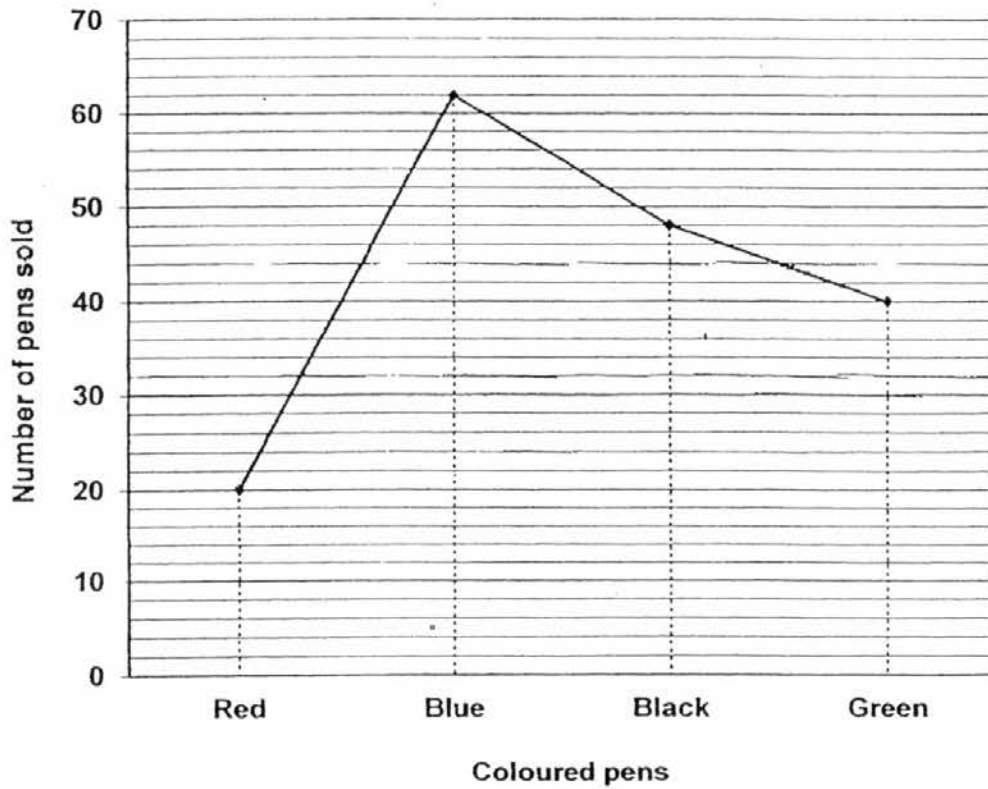

- (a) What was the difference between the number of blue and black pens sold?
- (b) Each red pen cost \$0.30 more than each green pen. Uncle Frank collected \$84 from selling the green pens. What was the price of 1 red pen?

Ans: (a) \_\_\_\_\_ [1]

(b) \_\_\_\_\_ [2]

10. Jake, Kate and Larry have a total of 2 550 stamps.  
Jake has four times as many stamps as Kate.  
Larry has half of the total number of stamps Jake and Kate have.  
How many more stamps does Larry have than Kate?

Do not write  
in this space

Ans: \_\_\_\_\_ [4]

11. Wahid and Arjay had a total of 1 760 marbles.  
When Wahid gave 120 marbles to Arjay, he would have 3 times as many marbles as Arjay.  
How many marbles did Wahid have at first?

Do not write  
in this space

Ans: \_\_\_\_\_ [4]

12. Mr Lim placed 25 pins in a row from one to the other end of a bulletin board at equal distance apart as shown in the diagram below. The distance between the first and last pin was 96 cm.

- (a) What was the distance between the first and eighth pin?
- (b) Mr Lim decided to remove 8 pins and rearrange the remaining pins at a new equal spacing. What was the new distance of each spacing?

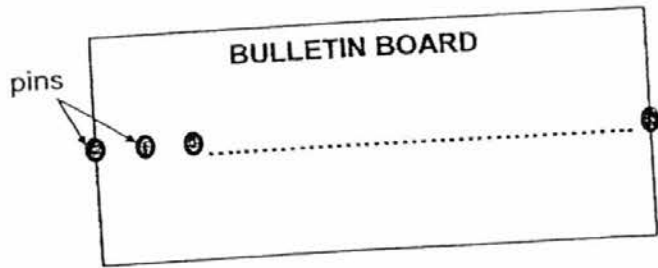

Do not write  
in this space

Ans: (a) \_\_\_\_\_ [3]

(b) \_\_\_\_\_ [2]



13. 12 shirts and 5 dresses cost \$247.50.  
7 similar shirts and 3 similar dresses cost \$145.40.  
What is the total cost of 1 shirt and 1 dress?

Do not write  
in this space

Ans:

[5]

End of Paper

YEAR : 2016  
 LEVEL : PRIMARY 5  
 SCHOOL : ROSYTH  
 SUBJECT : MATHEMATICS  
 TERM : CA1

Paper 1

Q1	1	Q4	4	Q7	3	Q10	2	Q13	3
Q2	1	Q5	3	Q8	3	Q11	3	Q14	1
Q3	2	Q6	1	Q9	4	Q12	1	Q15	2

Q16 53 101, 53 100, 53 010, 53 001

Q17 \$90 499

Q18 44

Q19 140

Q20 49.99

Q21 23.69

Q22 36 cm

Q23

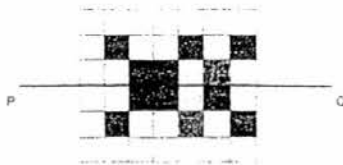

Q24

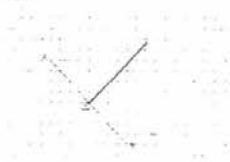

Q25  $3 + 5 = 8$   
 $40 \div 8 = 5$   
 $3 \times 5 \Rightarrow \underline{15 \text{ boys}}$

Q26  $R \rightarrow 5.9 \times 6 = 35.4$   
 $J \rightarrow 35.4 - 9.9 \Rightarrow \underline{25.5 \text{ km}}$

Q27

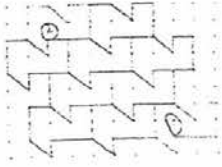

Q28  $60 + 80 + 20 + 30 \Rightarrow$  190 books

Q29  
A  $\rightarrow 25 \times 14 = 350$   
B  $\rightarrow 5 + 5 = 10$   
L  $\rightarrow 350 \div 10 = 35$   
P  $\rightarrow 35 + 35 + 10 + 10 \Rightarrow$  90 cm

Q30  
B  $\rightarrow 48 \div 4 = 12$   
L  $\rightarrow 12 \times 3 = 36$   
A  $\rightarrow 36 \times 12 \Rightarrow$  432 cm<sup>2</sup>

Paper 2

Q1 7

Q2 8, 16, 24

Q3  $6.8 + 0.450 \Rightarrow$  7.25 kg

Q4 6 pupils

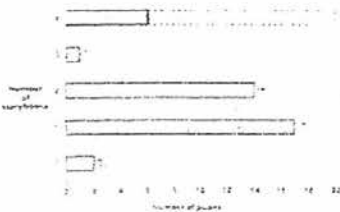

Q5  
 $2588 - 860 = 1728$   
12 month  $\rightarrow 1728$   
1 month  $\rightarrow 1728 \div 12 \Rightarrow$  \$144

Q6  
 $13P + 6E = 8.80$   
 $22P = 8.80$   
 $1P = 8.80 \div 22 \Rightarrow$  \$0.40

Q7  
Length  $\rightarrow 80 + 4 = 84$   
Breadth  $\rightarrow 46 + 4 = 50$   
Area  $\rightarrow 50 \times 84 = 4200$   
Area of field  $\rightarrow 80 \times 46 = 3680$   
Foot path  $\rightarrow 4200 - 3680 \Rightarrow$  520 m<sup>2</sup>

Q8

NO.	1	2	3	4
x 7	7	14	21	28
- 4	3	10	17	24
x 5	5	10	15	20
+ 4	9	14	19	24

Ans: 4 pupils

Q9a

$$62 - 48 \Rightarrow \underline{14 \text{ pens}}$$

Q9b

$$84 \div 40 = 2.1$$

$$2.1 + 0.30 \Rightarrow \underline{\$2.40}$$

Q10

$$2550 \div 15 = 170$$

$$170 \times 3 \Rightarrow \underline{510 \text{ stamps}}$$

Q11

$$4u = 1760$$

$$1u = 1760 \div 4 = 440$$

$$3u = 440 \times 3 = 1320$$

$$1320 + 120 \Rightarrow \underline{1440 \text{ marbles}}$$

Q12a

$$25 \text{ pins} \rightarrow 24 \text{ gaps}$$

$$96 \div 24 = 4$$

$$8 \text{ pins} \rightarrow 7 \text{ gaps}$$

$$7 \times 4 \Rightarrow \underline{28 \text{ cm}}$$

Q12b

$$25 - 8 = 17$$

$$17 \text{ pin} \rightarrow 16 \text{ gap}$$

$$96 \div 16 \Rightarrow \underline{6 \text{ cm}}$$

Q13

$$7S + 3D = 145.40$$

(x 2)

$$14S + 6D = 290.80$$

$$290.80 - 247.50 = 43.30$$

$$43.30 \times 6 = 259.80$$

$$259.80 \rightarrow 12S + 6D$$

$$259.80 - 247.50 = 12.30$$

$$12.30 \rightarrow 1D$$

$$12.30 \times 3 = 36.90$$

$$145.40 - 36.90 = 108.50$$

$$108.50 \div 7 = 15.50$$

$$15.50 \rightarrow 1S$$

$$15.50 + 12.30 \Rightarrow \underline{\$27.80}$$

End