



CATHOLIC HIGH SCHOOL
SEMESTRAL ASSESSMENT TWO (2018)
PRIMARY FOUR
SCIENCE
BOOKLET A

Name: _____ ()

Class: Primary 4 - _____

Date: 31 October 2018

28 questions

56 marks

Total Time for Booklets A and B: 1 hour 30 minutes

INSTRUCTIONS TO CANDIDATES

Do not turn over this page until you are told to do so.

Follow all instructions carefully.

Answer all questions.

Shade your answers in the Optical Answer Sheet (OAS) provided.

This booklet consists of 22 printed pages, excluding the cover page.

Booklet A (28 × 2 marks)

For each question from 1 to 28, four options are given. One of them is the correct answer. Make your choice (1, 2, 3 or 4). Shade your answer on the Optical Answer Sheet. (56 marks)

- 1 A millipede coils itself into a tight spiral when touched.

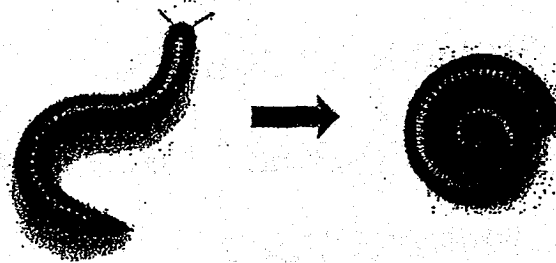

This shows that the millipede is a living thing because it can _____.

- (1) grow
 - (2) breathe
 - (3) respond
 - (4) reproduce
- 2 Which one of the animals shown below is not an insect?

(1)



(2)



(3)

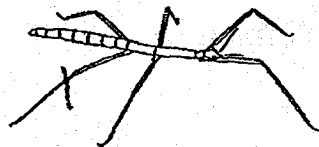

(4)

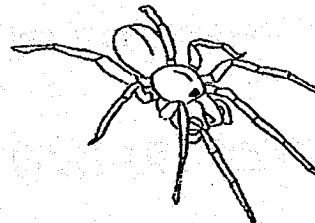

3 Which one of the following objects can be bent easily without breaking?

(1)

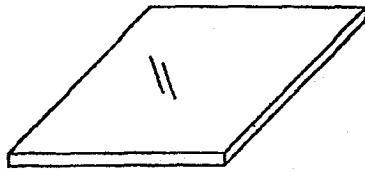

a sheet of glass

(2)

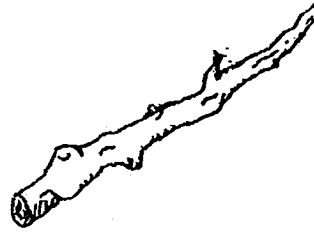

a wooden stick

(3)

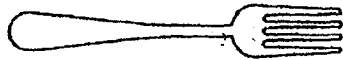

a plastic fork

(4)

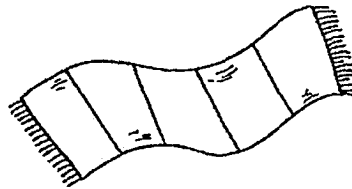

a towel

4 In which part of the digestive system is food absorbed into the blood?

(1) gullet

(2) stomach

(3) large intestine

(4) small intestine

5 Which part, (1), (2), (3) or (4), makes food for the plant?

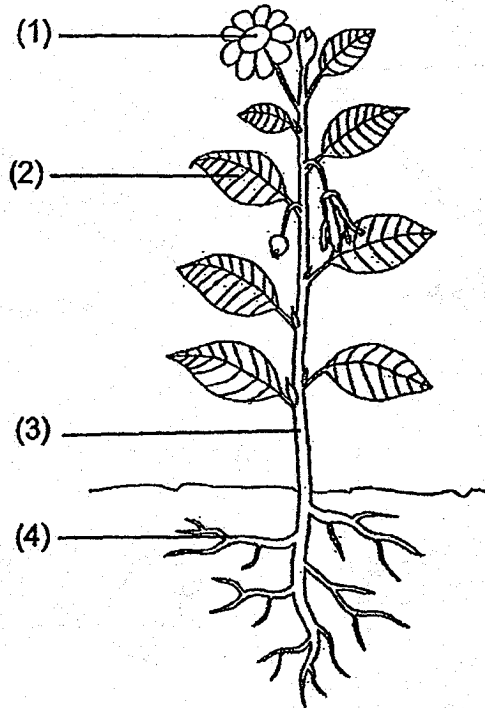

6 In which one of the following will the two magnets push each other away?

(1)



(2)

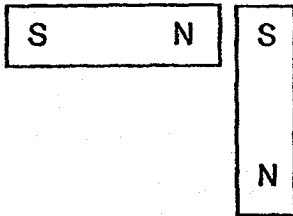

(3)

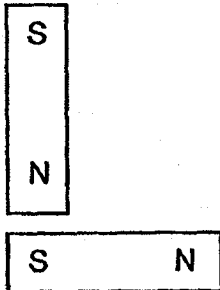

(4)

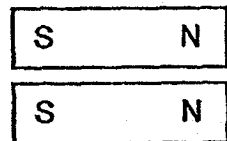

7 A, B, C and D are the various stages in the life cycle of a mosquito.

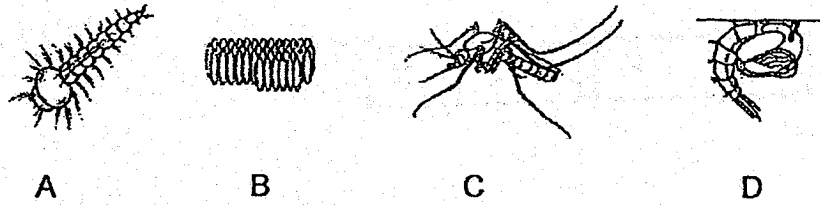

Which one of the following correctly shows the life cycle of a mosquito?

(1)

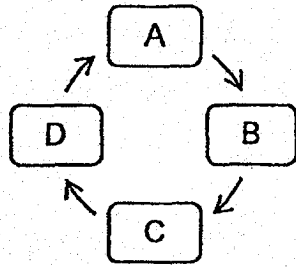

(2)

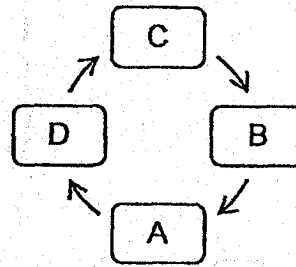

(3)

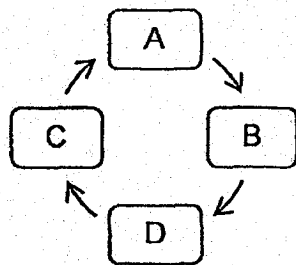

(4)

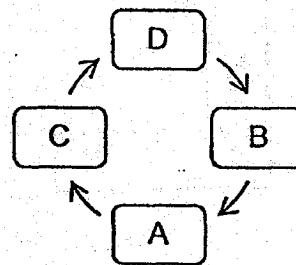

8 Which one of the following properties is correct for both air and water?

- (1) They can be seen.
- (2) They take up space.
- (3) They have definite shapes.
- (4) They have definite volumes.

9 Which one of the following is a source of light?

(1)



eyes

(2)

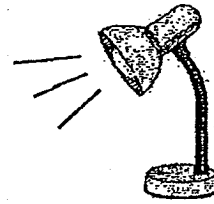

lamp

(3)



mirror

(4)



moon

10 Jason placed a metal spoon in a cup of hot water.

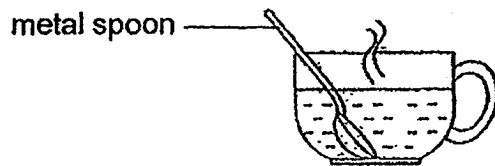

a cup of hot water

The spoon became hot after a while.

Which one of the following explains this?

- (1) The cup lost heat to the spoon.
- (2) The spoon lost heat to the hot water.
- (3) The hot water gained heat from the spoon.
- (4) The spoon gained heat from the hot water.

11 Study the chart below.

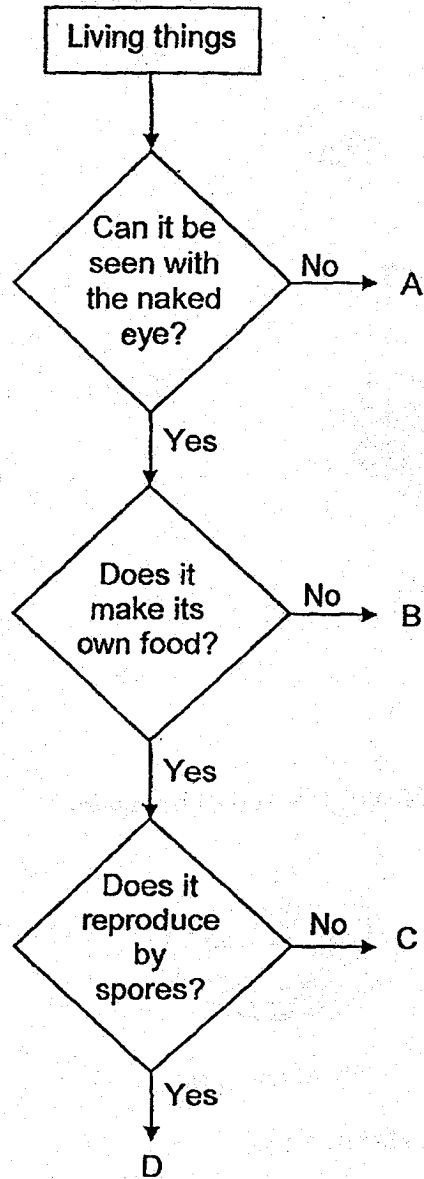





Which one of the following correctly identifies A, B, C and D?

	A	B	C	D
(1)	bacteria	mushroom	rose	bird's nest fern
(2)	bracket fungi	bread mould	mushroom	moss
(3)	bread mould	hibiscus	moss	bird's nest fern
(4)	bacteria	bracket fungi	hibiscus	rose

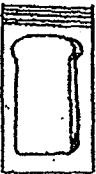
- 12 Dennis conducted an experiment to find out more about bread mould. He took four similar slices of bread, A, B, C and D, and added different amounts of water on bread B, C and D. They were all placed in sealed bags on the dining table.

The amount of bread mould growing on them was recorded in the table below after 8 days.

	Bread A	Bread B	Bread C	Bread D
Amount of water added to the bread (ml)	0	10	20	5
Amount of bread mould observed	None	3 patches	6 patches	1 patch
				

Dennis made the following statements based on his observations.

- P Bread mould needs water to grow.
- Q Bread mould grows better in bags.
- R Bread mould grows faster when there is more water.

Which of the statements above is/are correct?

- (1) R only
- (2) P and Q only
- (3) P and R only
- (4) P, Q and R

- 13 To keep the floor dry in a building on a rainy day, people entering the building are to keep their wet umbrellas in umbrella bags placed at the entrance as shown in the diagram below.



What are the two most important properties the umbrella bag must have to best serve this purpose?

- A flexible
- B waterproof
- C able to float
- D allows most light to pass through

- (1) A and B only
- (2) A and D only
- (3) B and C only
- (4) C and D only

- 14 Some children were discussing about the human digestive system.

Peter Digestion of food starts in the stomach only.

Jenny Chewing our food is part of the digestion process.

Mary The digestive system only breaks down food but does not absorb food.

Who made the correct statement(s)?

- (1) Jenny
- (2) Peter and Mary
- (3) Mary and Jenny
- (4) Peter, Mary and Jenny

15 Janet magnetised an iron rod XY as shown in the diagram below.

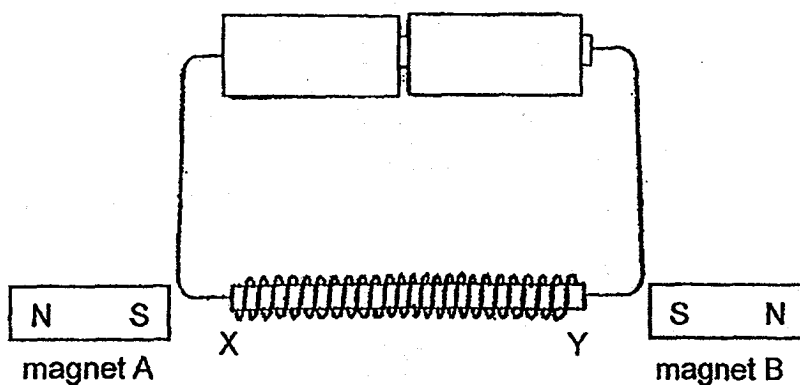

She observed that magnet A was attracted to the iron rod at point X while magnet B was repelled from the iron rod at point Y.

Based on Janet's observation, what would the poles X and Y of the iron rod be when it was magnetised?

	X	Y
(1)	North	South
(2)	North	North
(3)	South	North
(4)	South	South

- 16 The diagram below shows a toy that makes use of magnets. A ball with a magnet in it floats in between two magnets G and H.

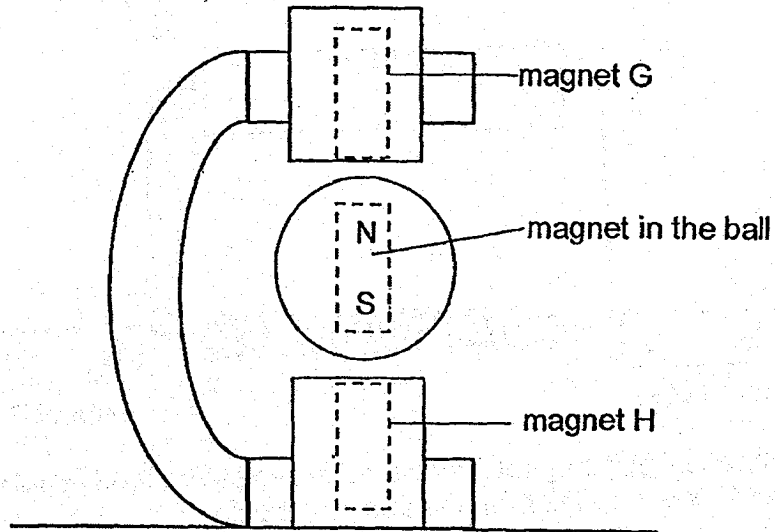

How should the magnets G and H be placed for the ball to float?

	magnet G	magnet H
(1)	<div style="border: 1px dashed black; padding: 5px; width: 40px; margin: 0 auto;"> N S </div>	<div style="border: 1px dashed black; padding: 5px; width: 40px; margin: 0 auto;"> N S </div>
(2)	<div style="border: 1px dashed black; padding: 5px; width: 40px; margin: 0 auto;"> N S </div>	<div style="border: 1px dashed black; padding: 5px; width: 40px; margin: 0 auto;"> S N </div>
(3)	<div style="border: 1px dashed black; padding: 5px; width: 40px; margin: 0 auto;"> S N </div>	<div style="border: 1px dashed black; padding: 5px; width: 40px; margin: 0 auto;"> S N </div>
(4)	<div style="border: 1px dashed black; padding: 5px; width: 40px; margin: 0 auto;"> S N </div>	<div style="border: 1px dashed black; padding: 5px; width: 40px; margin: 0 auto;"> N S </div>

- 17 Daryl grew some green bean seeds in a cup and placed it near a window. He then measured the height of the seedlings every four days.

Which one of the following graphs best represents the height of the seedlings over 16 days?

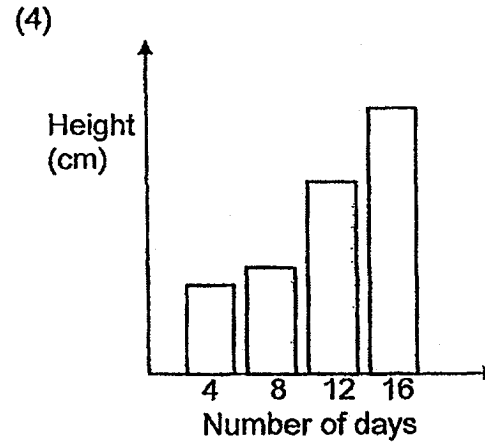
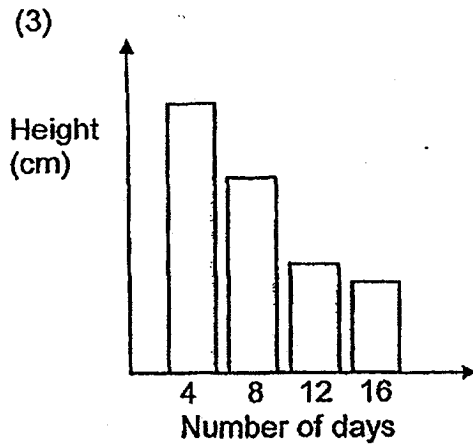
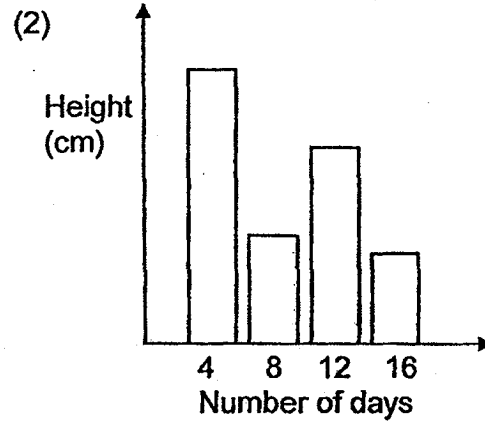
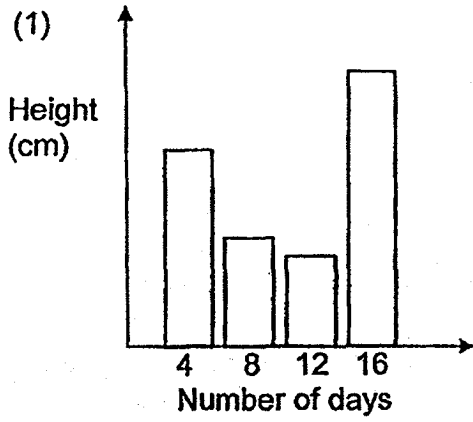

18 The graph below shows the length of each stage in the life cycle of an insect.

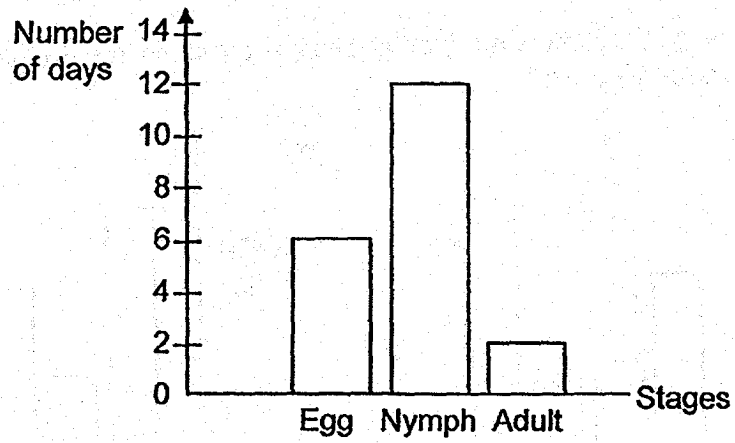

How many days would it take for the insect to become an adult after the egg is laid?

- (1) 6
- (2) 12
- (3) 18
- (4) 20

19 Three identical glasses contained the following objects.

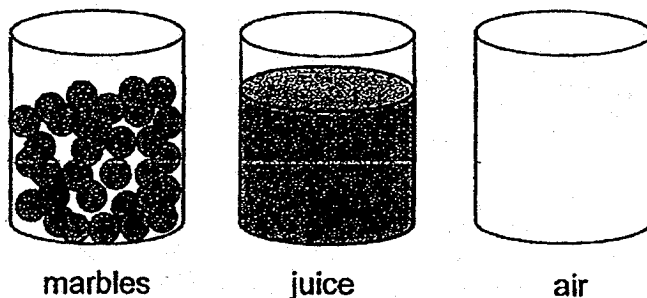

A jug of water was poured into each glass at the same time.

In what order, from first to last, would the water overflow?

	First	→	Last
(1)	air		marbles
(2)	marbles		air
(3)	juice		air
(4)	marbles		juice

- 20 Abdul prepared two identical syringes, A and B, each containing different types of matter, X and Y.

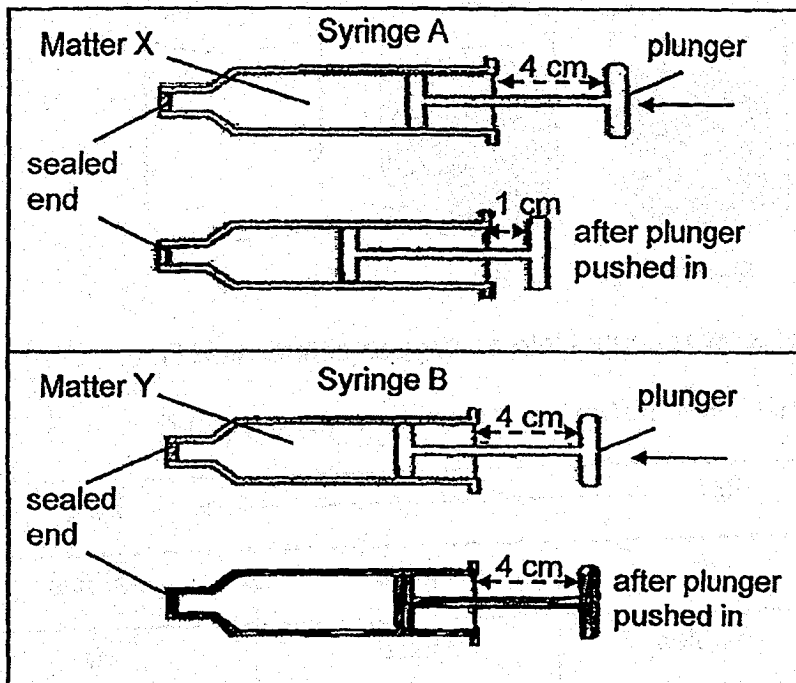

Abdul tried pushing the plunger in each syringe and observed what happened. He recorded the distance moved by each syringe in the table below.

Syringe	Distance moved by plunger (cm)
A	3
B	0

Which one of the following correctly identifies X and Y?

	X	Y
(1)	oil	sand
(2)	rice	oxygen
(3)	air	milk
(4)	water	sugar

- 21 Ali conducted an experiment in a dark room. He placed four wooden boxes with holes, P, Q, R and S, in a straight line on a table as shown below.

When the candle was lighted, Ali could see the light through the hole in Box S.

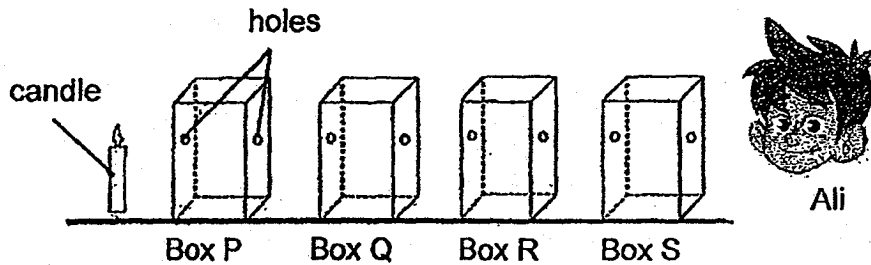

Ali moved Box R such that it was no longer in line with the rest. He realised that he could no longer see the light through the hole in Box S.

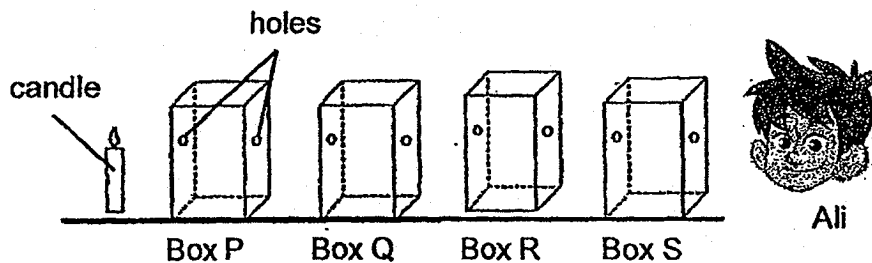

Which one of the following statements best explains his observations?

- (1) Light can be reflected.
- (2) Light travels in a straight line.
- (3) Light cannot pass through small holes.
- (4) Light is reflected off the box in other directions.

- 22 Gopal set up an experiment as shown below. He placed object A 10 cm away from the torch and the light sensor 10 cm away from the object.

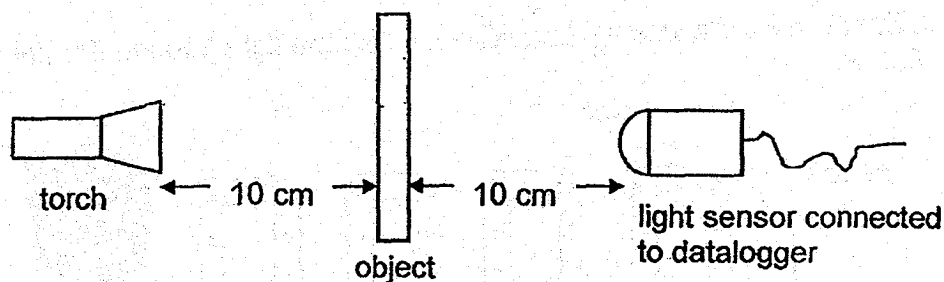

He repeated the same experiment using objects, B, C and D. The four objects, A, B, C and D, were similar in size and thickness, but were made of different materials. He recorded the amount of light detected by the light sensor in the table below.

Object	Amount of light detected by light sensor (units)
A	0
B	425
C	150
D	259

What was the aim of Gopal's experiment?

- (1) To find out how the thickness of the object affects the amount of light passing through.
- (2) To find out how the amount of light passing through the object affects the materials used.
- (3) To find out how the materials used affects the amount of light passing through the object.
- (4) To find out how the position of the light source affects the amount of light passing through the object.

- 23 The diagram below shows three identical balls, A, B and C, placed at different distances in front of a screen. A light source was switched on and the shadows of the balls were cast on the screen.

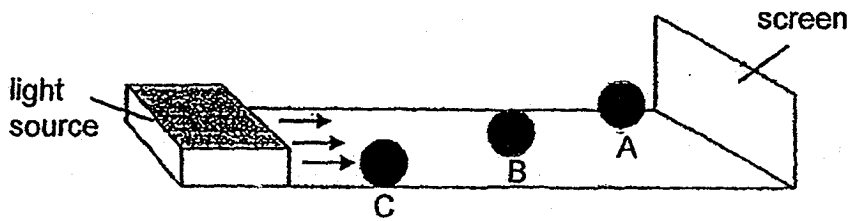

Assuming the balls do not block one another, which one of the following diagrams correctly shows the shadows of the balls, A, B and C, on the screen?

(1)

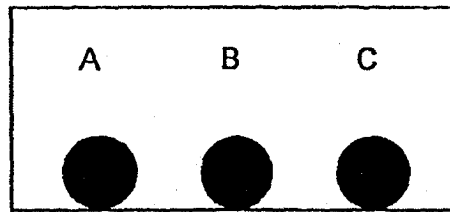

(2)

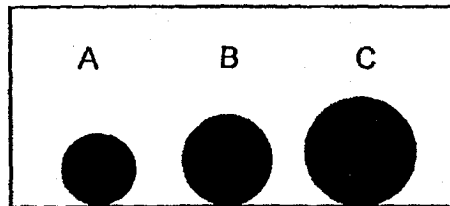

(3)

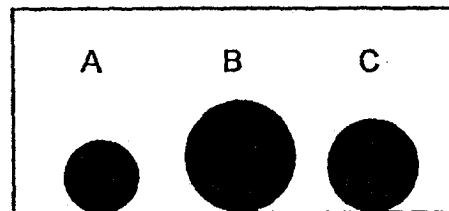

(4)

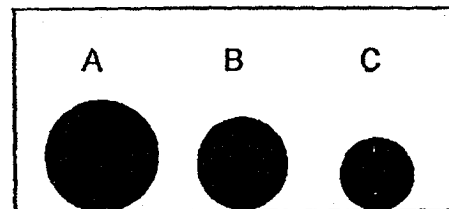

24 The diagram below shows a shadow formed on a screen.

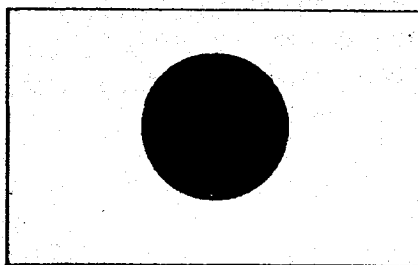

Which of the following could not have formed the shadow shown above?

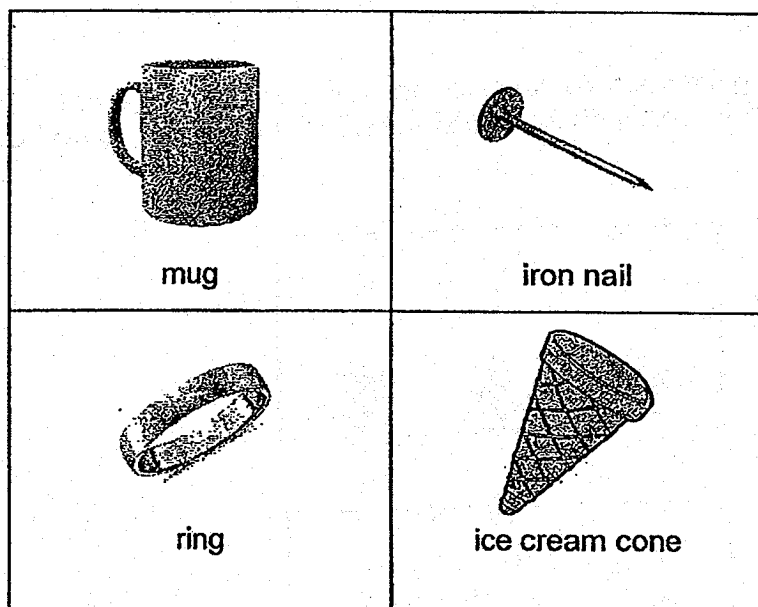

- (1) ring and mug
- (2) mug and iron nail
- (3) ice cream cone and ring
- (4) iron nail and ice cream cone

- 25 Nancy poured some hot milk into a cup as shown below. She wanted to keep her milk hot for as long as possible.

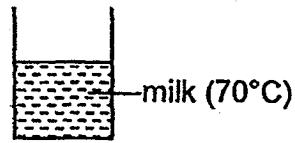

Which one of the following arrangements is the best method to keep the milk hot for the longest time?

(1)

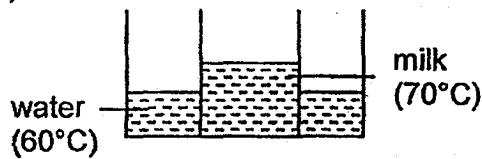

(2)

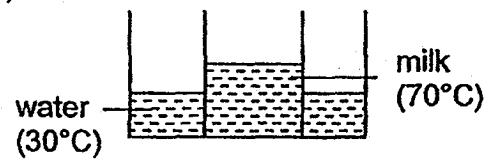

(3)

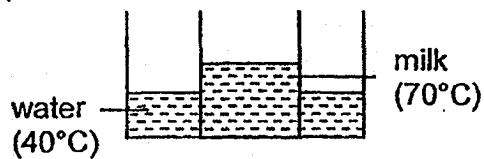

(4)

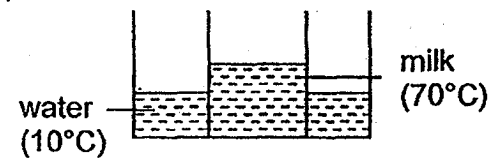

- 26 Some ice cubes are put into a glass of drink. The ice cubes melt after a while.

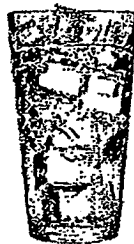

How does adding ice cubes make the drink colder?

- (1) The ice cubes melt so there is more drink.
- (2) The ice cubes gain heat from the drink as they melt.
- (3) The heat from the ice cubes moves to the drink as they melt.
- (4) The heat from the ice cubes moves to the glass holding the drink.

- 27 Matter can exist in three states, solid, liquid or gas, depending on the temperature.

The diagram below shows how matter can change from one state to another.

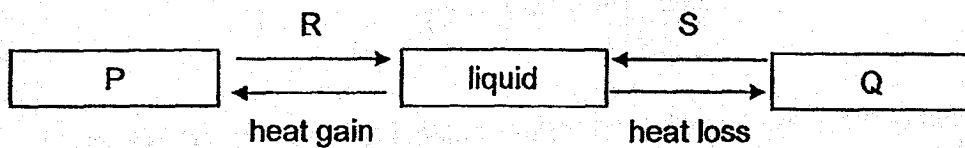

What could P, Q, R and S be?

	P	Q	R	S
(1)	gas	solid	heat gain	heat loss
(2)	solid	gas	heat gain	heat loss
(3)	solid	gas	heat loss	heat gain
(4)	gas	solid	heat loss	heat gain

- 28 Joe carried out an experiment to find out how well different materials reduce heat loss.

He wrapped three identical empty drink cans in different materials. He then put equal amounts of water at 50°C into each can.

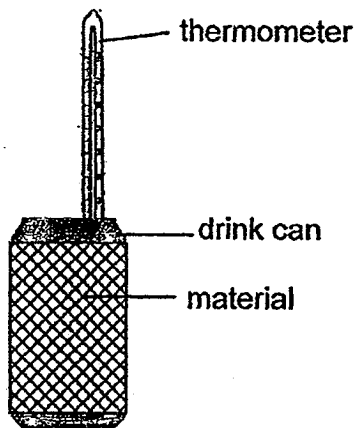

After five minutes, he measured the temperature of the water and recorded it in the table below.

Material	Temperature of water after five minutes (°C)
A	39
B	45
C	42

Which one of the following lists the materials from the most effective at reducing heat loss to the least effective?

- (1) B, C, A
- (2) B, A, C
- (3) C, B, A
- (4) A, C, B

End of Booklet A

THE UNIVERSITY OF CHICAGO

PHYSICS DEPARTMENT

PHYSICS 311

LECTURE 1

MECHANICS

LECTURE 2

LECTURE 3

LECTURE 4

LECTURE 5

LECTURE 6

LECTURE 7

LECTURE 8

LECTURE 9

LECTURE 10

LECTURE 11

LECTURE 12

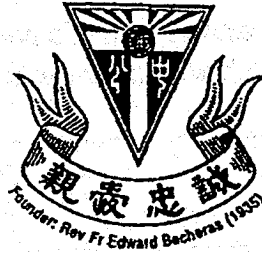

CATHOLIC HIGH SCHOOL
SEMESTRAL ASSESSMENT TWO (2018)
PRIMARY FOUR
SCIENCE
BOOKLET B

Name: _____ ()

Class: Primary 4 - _____

Date: 31 October 2018

Parent's Signature: _____

Booklet A	56
Booklet B	44
Total	100

13 questions

44 marks

Total Time for Booklets A and B: 1 hour 30 minutes

INSTRUCTIONS TO CANDIDATES

Do not turn over this page until you are told to do so.

Follow all instructions carefully.

Answer all questions.

Write your answers in this booklet.

This booklet consists of 14 printed pages, excluding the cover page.

Booklet B (44 marks)

For questions 29 to 41, write your answers in this booklet.

The number of marks available is shown in brackets [] at the end of each question or part question. (44 marks)

29 Study the chart below.

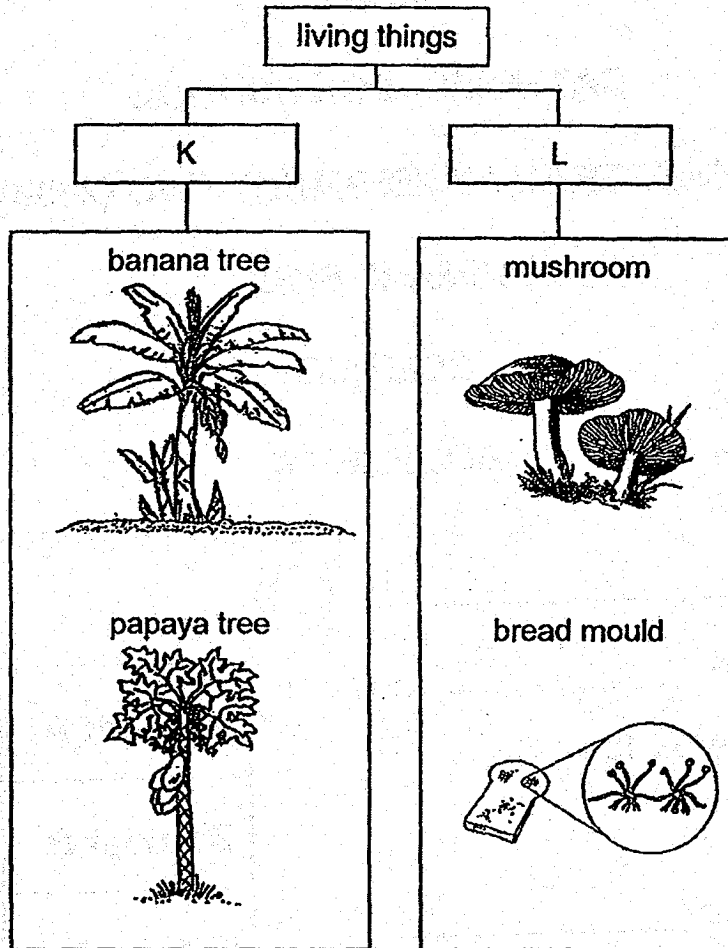

Choose the correct words from the box to give suitable headings for K and L. [2]

flowering plants non-flowering plants bacteria fungi

K: _____

L: _____

(Go on to the next page)

SCORE	2
-------	---

30 Mary places a magnet near an iron rod and the iron rod moves towards the magnet.



(a) The magnet exerts a _____ on the iron rod. [1]

(b) Choose the correct word from the box to answer the question. [1]

strong	magnetic	flexible
--------	----------	----------

Mary's observation shows that iron is a _____ material.

31 The diagram below shows the stages in the life cycle of a cockroach.

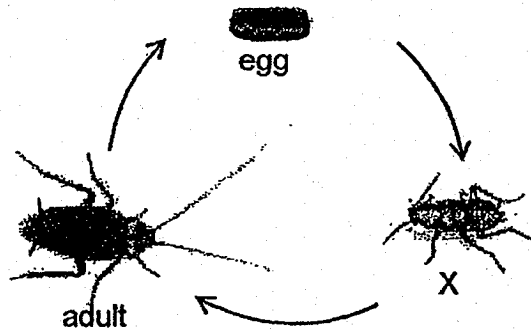

(a) Name stage X. [1]

(b) State one other animal that has a similar life cycle as a cockroach. [1]

(Go on to the next page)

SCORE	4
-------	---

32 The diagram below shows a bottle of milk.

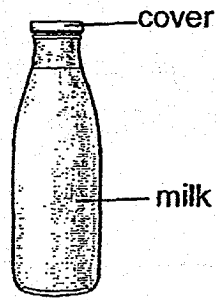

Complete the sentences to state if the parts are solid, liquid or gas.

(a) The cover is a _____ [1]

(b) Milk is a _____ [1]

(Go on to the next page)

SCORE	2
-------	---

- 33 (a) James placed a metal rod and a wooden rod into a tank of boiling water as shown below. Equal amounts of wax were put on both rods.

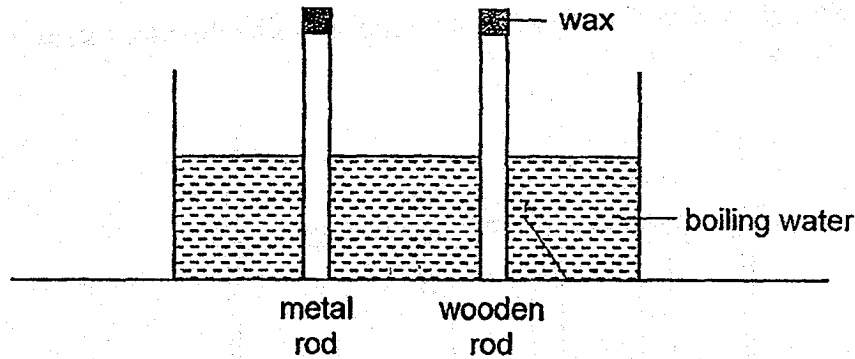

What would he observe and why? [2]

The wax on the metal rod melted _____ than the wax on the wooden rod as metal is a _____ conductor of heat than wood.

- (b) Some children wanted to find out which material keeps a drink hot for the longest period of time. They filled three containers, A, B and C, with hot water. They placed them in the same place.



What other variables must be kept the same for the experiment to be fair? Put a tick (✓) in the correct boxes. [2]

Variables	Kept constant
Size of containers	
Material of containers	
Volume of water in containers	
Final temperature of water in containers	

(Go on to the next page)

SCORE	4
-------	---

- 34 (a) Sheela hung four different strips of material, J, K, L and M, each with different thickness from the same height. The ends of the four strips of material were dipped in four similar containers of water.

She wanted to find out which material absorbs the most water after ten minutes.

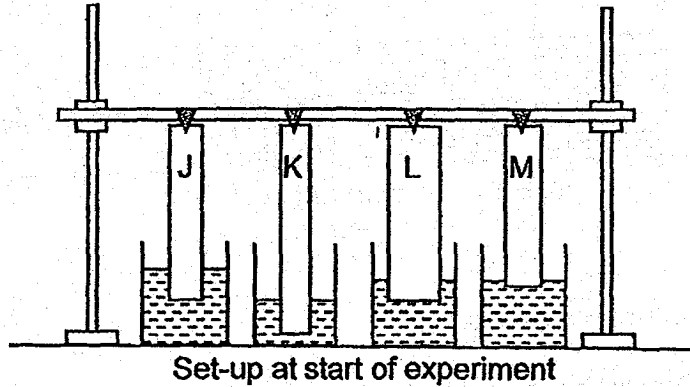

However, Sheela's classmates said that she had not conducted a fair test.

Besides the length and width of the materials, write down two other changes that Sheela should make in order for her experiment to be fair. [2]

Change 1 : _____

Change 2 : _____

(Go on to the next page)

SCORE	2
-------	---

Continue from question 34

(b) Study the chart below.

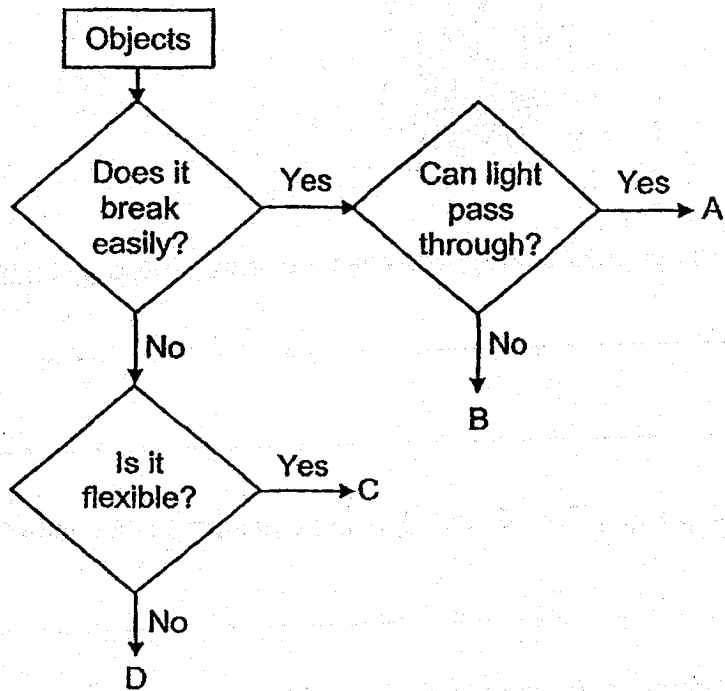

(i) Based on the chart above, state the properties of object D. [1]

(ii) Name the material that object A can be made of. [1]

(Go on to the next page)

SCORE	2
-------	---

35 The diagram below shows the human digestive system.

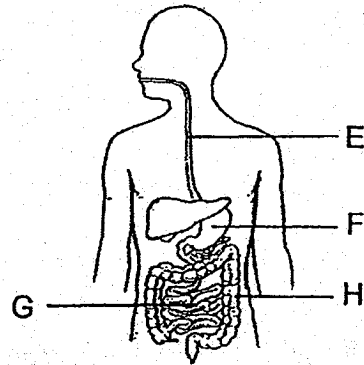

(a) Name the parts of the digestive system represented by F and H. [1]

F: _____

H: _____

(b) In which part(s), E, F, G and H, is/are digestive juices added? [1]

(c) Explain what happens at parts G and H. [2]

G: _____

H: _____

(Go on to the next page)

SCORE	4
-------	---

36 Jeremy wanted to make a magnet using the electrical method.

- (a) Other than a battery, what other items would he need?
Tick (✓) the correct box(es).

[1]

Items	Tick (✓)
iron rod	
aluminium rod	
copper wire	
eraser	

- (b) When he tested the electromagnet that he had made, he had the following results.

	plastic clips	steel clips
Number of clips attracted	0	4

He re-constructed his electromagnet and tested again. The number of steel clips attracted increased. Predict the number of plastic clips attracted by writing your prediction in the table below.

[1]

	plastic clips	steel clips
Number of clips attracted		8

- (c) Give a reason for your answer in (b)

[1]

- (d) Without replacing any of the items or adding new items, suggest what he had done to the electromagnet in order to attract 8 steel clips.

[1]

(Go on to the next page)

SCORE	4
-------	---

37 Study the chart below.

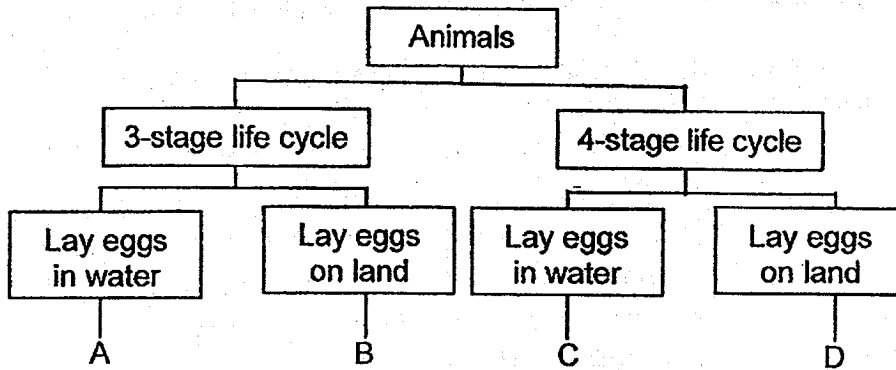

(a) Based on the chart above, state one difference between animals B and D. [1]

(b) Which animals, A, B, C or D, represents a beetle? [1]

(c) Jack placed a butterfly egg in a sealed jar as shown. After one week, the egg hatched into a larva.

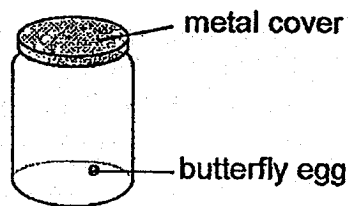

Give two suggestions how Jack can improve the above set-up to ensure that the butterfly larva survives after it hatches. [2]

Suggestion 1 : _____

Suggestion 2 : _____

(Go on to the next page)

SCORE	4
-------	---

- 38 Justin conducted an experiment with two identical jars, X and Y, of capacity 300 cm^3 . Each jar contained 300 cm^3 of air.

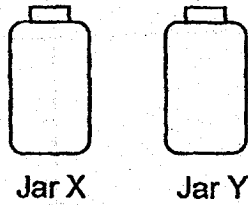

He connected a pump to both jars as shown in the diagram below. He then pumped in another 100 cm^3 of air into Jar X. Both jars were then placed on a balance.

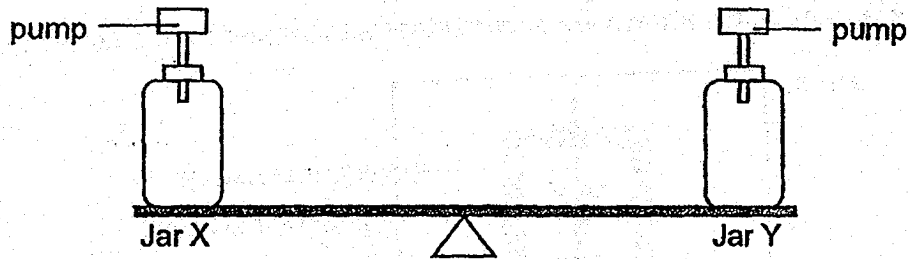

- (a) State what would happen to the balance after 100 cm^3 of air was pumped into Jar X. [1]

- (b) What was the final volume of air in Jar X? [1]

_____ cm^3

- (c) State two properties of air that are shown in the experiment above. [2]

Property 1 : _____

Property 2 : _____

(Go on to the next page)

SCORE	4
-------	---

- 39 The set-up below shows light from a torch shining on two shapes, S and T, made from thick cardboard. The shapes are placed at different distances from the torch.

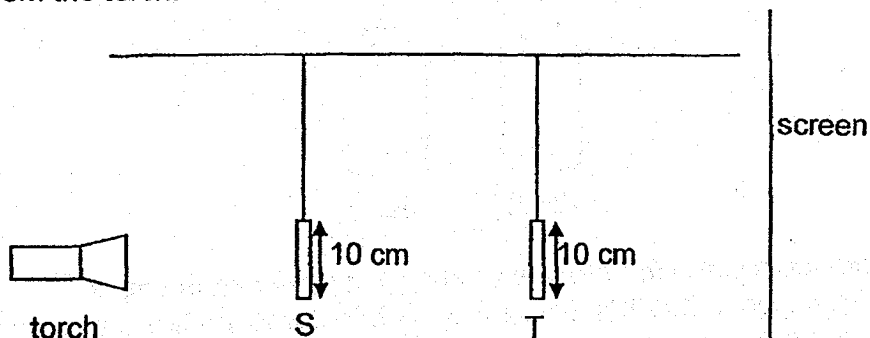

The diagram below shows the shadow that was formed on the screen.

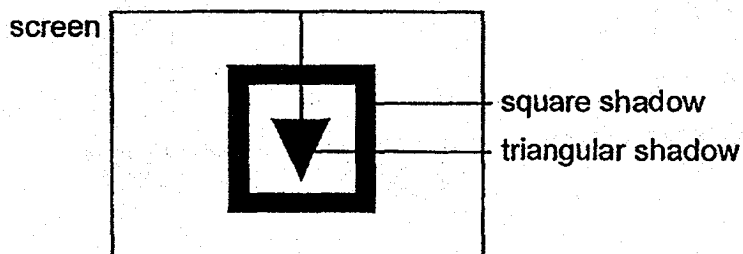

- (a) Which shape, S or T, is a triangle? [1]

- (b) Suggest one way to increase the size of the triangular shadow without changing the size of the square shadow. [1]
(You cannot add, remove or replace any of the materials.)

(Go on to the next page)

SCORE	2
-------	---

Continue from question 39

Object T was removed and the distance between the torch and the screen was changed.

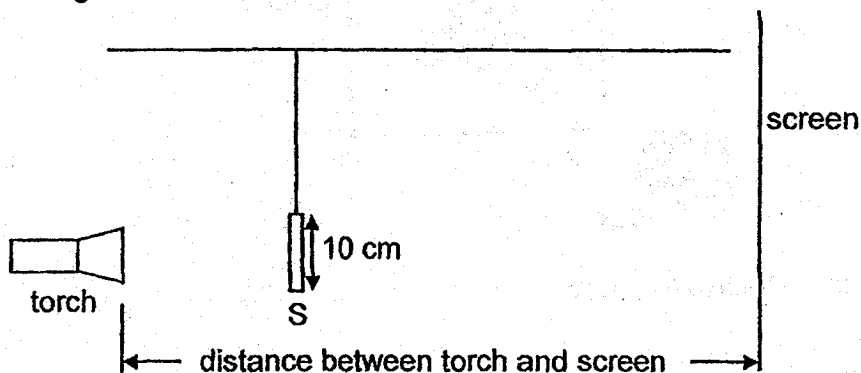

The height of the shadow formed on the screen was recorded in the table below.

Distance between torch and screen (cm)	Height of shadow (cm)
60	28
55	30
50	32
45	X
40	36

(c) Based on the table above, what could be the value of X? [1]

(d) Based on the table above, what is the relationship between the distance between the torch and the screen and the height of the shadow? [1]

(Go on to the next page)

SCORE	2
-------	---

- 40 (a) Shawn wants to investigate if the size of his hand shadow will be affected by the distance of his hands from the light source as shown in the diagram below.

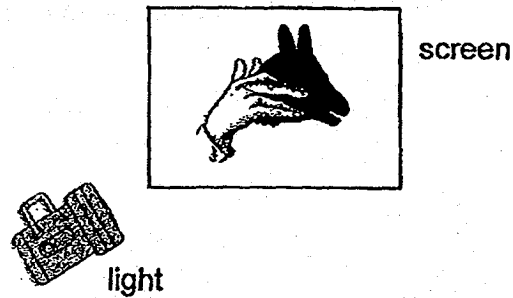

- (i) How is a shadow formed? [1]

- (ii) What should Shawn do if he wants a bigger shadow? Tick (✓) the correct box(es). [2]

Shawn should...	Tick (✓)
move the torch nearer to his hand	<input type="checkbox"/>
move his hand nearer to the screen	<input type="checkbox"/>
move the torch further away from his hand	<input type="checkbox"/>
move his hand further away from the screen	<input type="checkbox"/>

- (b) Some toys are placed in a box. Shawn looks into the box from a distance.



- Which object(s) can Shawn see clearly? [1]

(Go on to the next page)

SCORE	4
-------	---

- 41 Mike filled a jar with some water at a temperature of 90°C . He placed an ice cube into it as shown in the diagram below.

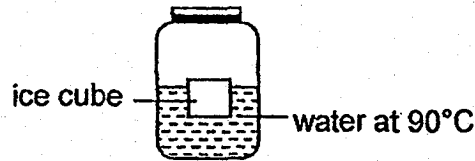

- (a) Would the temperature of the water in the jar after five minutes be higher than, same as or lower than 90°C ? Give a reason why. [2]

- (b) Mike placed four similar ice cubes in four jars, K, L, M and N. The jars were of similar size but made of different materials. He left the jars on a table in the living room.

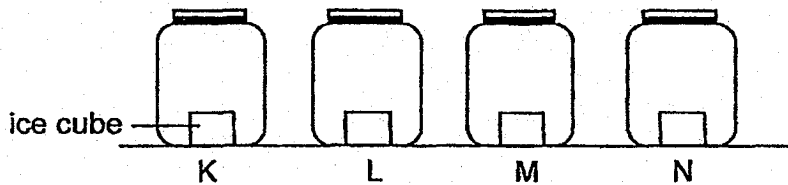

He recorded the time taken for the ice to melt completely and plotted the readings in the graph below.

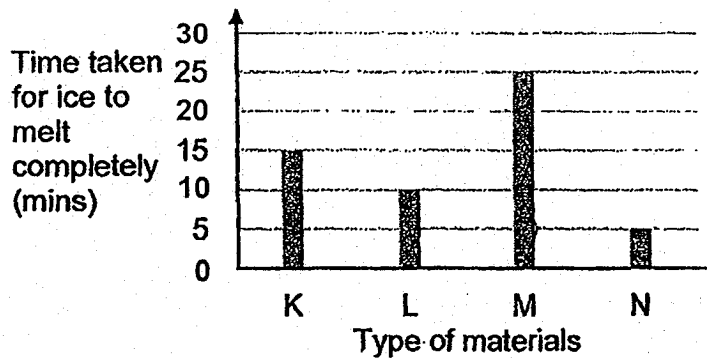

Which material is most suitable to make an ice cream container so that the ice cream will not melt so quickly? Explain your answer. [2]

End of Booklet B

SCORE	4
-------	---

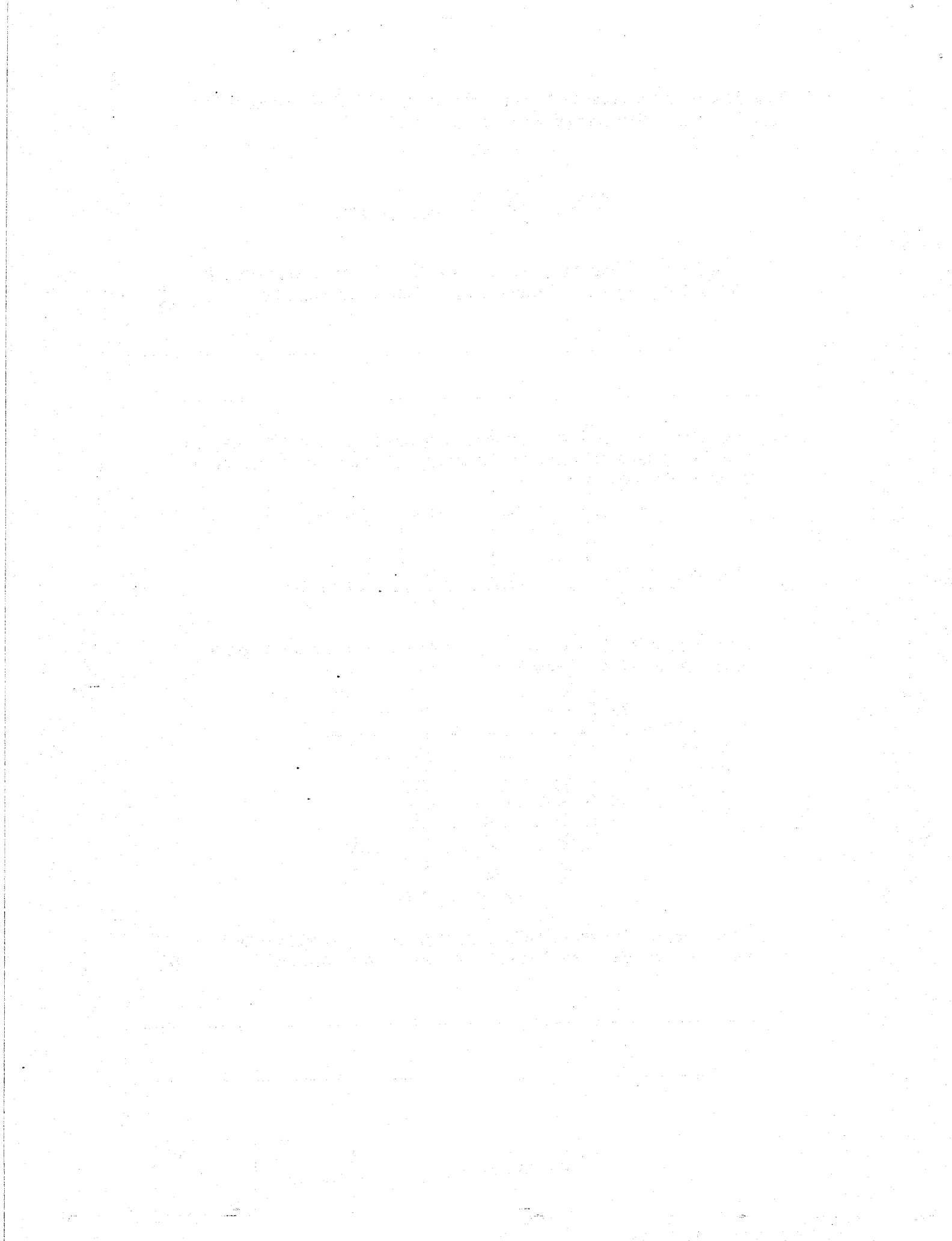

EXAM PAPER 2018 (P4)

SCHOOL : CATHOLIC HIGH

SUBJECT : SCIENCE

TERM : SA2

Q1	Q2	Q3	Q4	Q5	Q6	Q7	Q8	Q9	Q10
3	4	4	4	2	4	2	2	2	4
Q11	Q12	Q13	Q14	Q15	Q16	Q17	Q18	Q19	Q20
1	3	1	1	1	3	4	3	3	3
Q21	Q22	Q23	Q24	Q25	Q26	Q27	Q28		
2	3	2	1	1	2	4	1		

Q29) K : Flowering plants

L : Fungi

Q30) a) force

b) magnetic

Q31) a) nymph

b) grasshopper

Q32) a) solid

b) liquid

Q33) a) The wax on the metal melted first than the wax on the wooden rod as metal is a better conductor of heat than wood.

b) Size of containers , Volume of water in containers

Q34) a) Change 1 : Pour the same amount of water

Change 2 : Make the thickness of the materials the same

b) i) It does not break easily and it is not flexible.

ii) glass

Q35) a) F : stomach

H : large intestine

b) F and G

c) G : The digested food is absorbed into the blood stream to all parts of the body.

H : The water from the undigested food is absorbed into the bloodstream.

Q36) a) iron rod , copper wire

b) 0

c) The plastic clip is not a magnetic material so it cannot be magnetized and attracted to the electromagnet.

d) He had increased the number of coils around the electromagnet.

Q37) a) B has a 3-stage life cycle and D has a 4-stage life cycle.

b) D

c) Suggestion 1 : Poke hole on the metal cover

Suggestion 2 : Put some leaves in the jar.

Q38) a) The balance will tilt towards Jar X.

b) 300 cm³

c) Property 1 : Air has mass

Property 2 : Air can be compressed

Q39) a) T

b) Bring T nearer to S

c) 34 cm

d) When the distance between the torch and screen decreases, the height of the shadow increases.

Q40) a) i) When light is blocked by an opaque object.

ii) move the torch nearer to his hand , move his hand further away from the screen.

b) bear , ball

Q41) a) The temperature of the water will be lower as the water los heat to the ice cube and surroundings.

b) M. Because the ice in M took the longest time to melt, so M is the poorest conductor of heat and the ice cube gained heat from the surroundings the slowest.

