

NANYANG PRIMARY SCHOOL

PRIMARY 4 SCIENCE

**SEMESTRAL ASSESSMENT 1
2018**

BOOKLET A

**Date : 8th May 2018
Duration : 1 h 45 min**

Name : _____ ()

Class: Primary 4 ()

**DO NOT OPEN THIS BOOKLET UNTIL YOU ARE TOLD TO DO SO.
FOLLOW ALL INSTRUCTIONS CAREFULLY.**

Booklet A consists of 21 printed pages including this cover page.

Section A (28 x 2 marks = 56 marks)

For each question from 1 to 28, four options are given. One of them is the correct answer. Make your choice (1, 2, 3 or 4). **Shade the correct oval (1, 2, 3 or 4) on the Optical Answer Sheet provided.**

1. Which of the following statements about all living things are true?

- A All living things need air, food and water.
- B All living things can make their own food.
- C All living things can respond to surrounding changes.
- D All living things can move from place to place on their own.

- (1) A and C only
- (2) A and D only
- (3) B, C and D only
- (4) A, B, C and D

2. Amanda classified the following things into two groups.

Living Things	Non-living Things
fern	car
rose	cockroach
orchid	textbook

Which one of the following has been **wrongly** classified?

- (1) car
- (2) fern
- (3) orchid
- (4) cockroach

3. Which one of the following correctly states the similarity and difference between a fern and a sunflower plant?

	Similarity	Difference
(1)	Both reproduce by spores.	The sunflower plant makes its own food but the fern does not make its own food.
(2)	Both reproduce by seeds.	The sunflower plant has a strong stem but the fern does not have a strong stem.
(3)	Both grow on land.	The sunflower plant bears flowers but the fern does not bear flowers.
(4)	Both make its own food.	The sunflower plant has roots but the fern does not have roots.

4. Study the flowchart below.

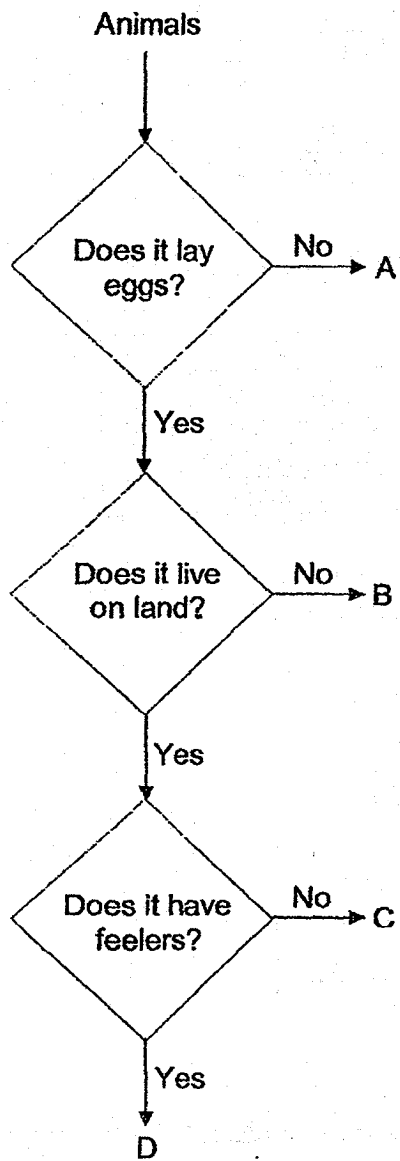

Based on the flowchart above, which animal is most likely a chicken?

- (1) A
- (2) B
- (3) C
- (4) D

5. Study the classification table below.

X	Y
dog	crocodile
rabbit	goldfish
tiger	snake

Which one of the following correctly represents X and Y?

	X	Y
(1)	have feathers	have hair
(2)	lay eggs	give birth to young alive
(3)	have hair	have feathers
(4)	give birth to young alive	lay eggs

6. Study the diagram of the plant shown below.

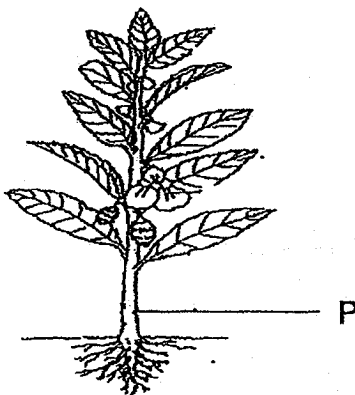

Which of the following statement(s) correctly state(s) the function(s) of part P?

- A It holds the plant upright.
- B It makes food for the plant.
- C It anchors the plant to the ground.

- (1) A only
- (2) A and C only
- (3) B and C only
- (4) A, B and C

7. Three pupils made the following statements about the function of each plant part.

Anne The stem hold the plant upright.

Bob The leaves have tiny holes to take in water

Chris The roots absorb water and mineral salts for the plant.

Which of the pupils have made the correct statements?

(1) Anne and Bob only

(3) Bob and Chris only

(2) Anne and Chris only

(4) Chris and Devi only

8. Study the flowchart below.

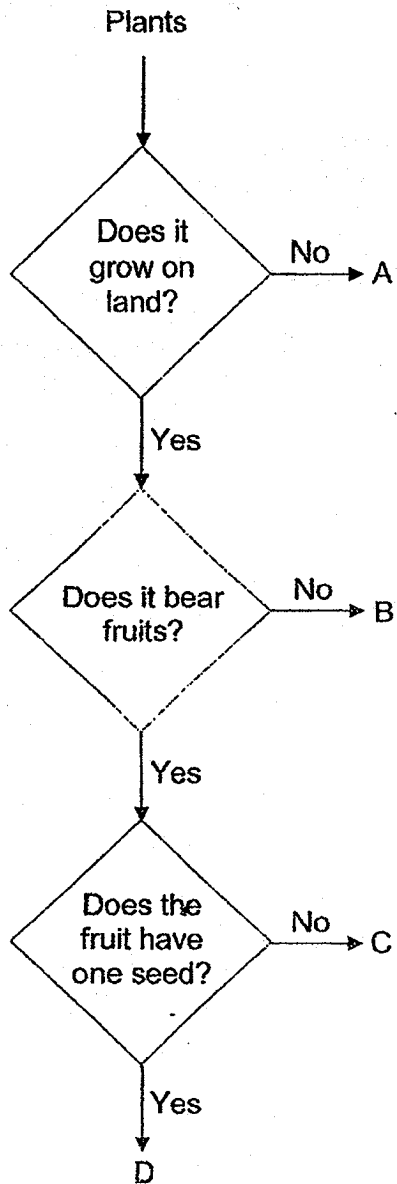

Based on the flowchart above, which plant is most likely a rambutan tree?

- (1) A
- (2) B
- (3) C
- (4) D

9. The diagram below shows the human digestive system.

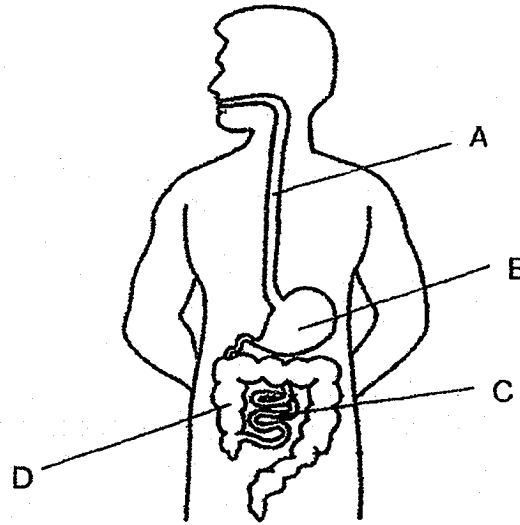

At which part, A, B, C or D is water being absorbed from the undigested food?

- (1) A
- (2) B
- (3) C
- (4) D

10. Study the chart below.

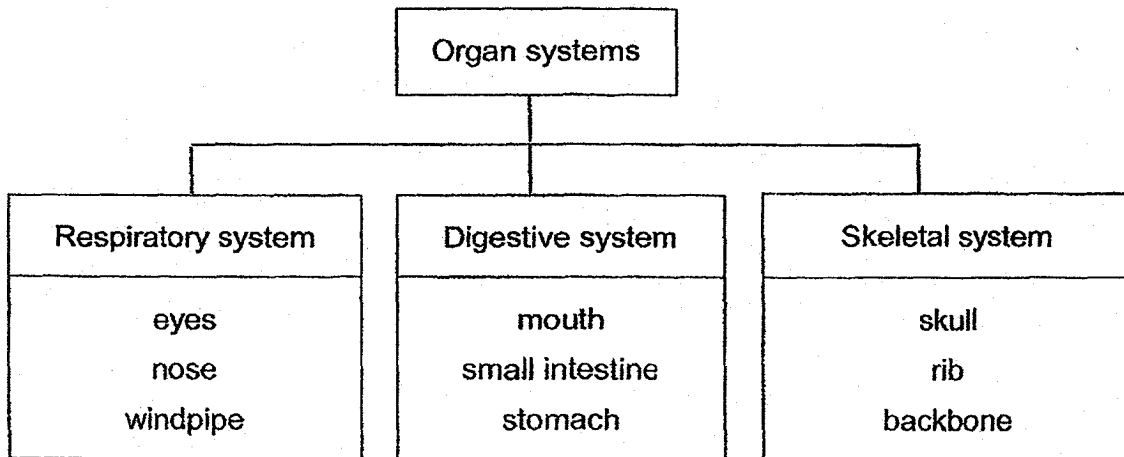

Which one of the following organs has been grouped **wrongly**?

- (1) skull
- (2) eyes
- (3) nose
- (4) small intestine

11. Which of the following activities make use of our muscular system?

- A Kicking a ball.
- B Playing the violin.
- C Eating a hamburger.
- D Walking to the bus-stop.

- (1) A and D only
- (2) B and C only
- (3) B, C and D only
- (4) A, B, C and D

12. Which of the following organ systems work together to carry digested food to all parts of the body?

- A Muscular system
- B Digestive system
- C Circulatory system
- D Respiratory system

- (1) A and C only
- (2) B and C only
- (3) A, B and D only
- (4) B, C and D only

13. Jeremy arranged 5 bar magnets as shown below. W, X and Y represent the poles of the bar magnets.

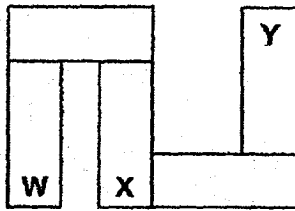

Which of the following arrangements are possible?

A

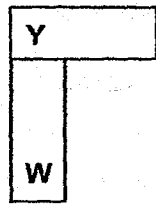

B

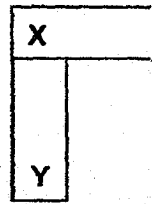

C

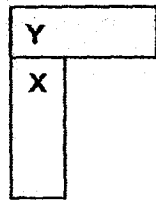

D

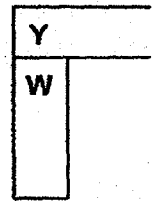

- (1) A and B only
 (3) B and D only

- (2) B and C only
 (4) C and D only

14. Kimmy set up an experiment to turn an iron nail into a temporary magnet using the stroke method. She stroked the nail 10 times in the same direction using a magnet. She then placed 10 paper clips on the table and observed that the iron nail could attract 3 paper clips.

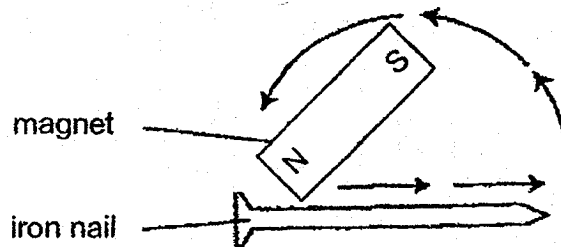

She wanted to repeat the experiment with another identical iron nail.

What could she do so that the iron nail could attract more clips in the second experiment?

- (1) Stroke the nail with the magnet 5 times in one direction.
- (2) Stroke the nail with the magnet 10 times in one direction.
- (3) Stroke the nail with the magnet 20 times in one direction.
- (4) Stroke the nail with the magnet 20 times in both directions.

15. Study the chart below.

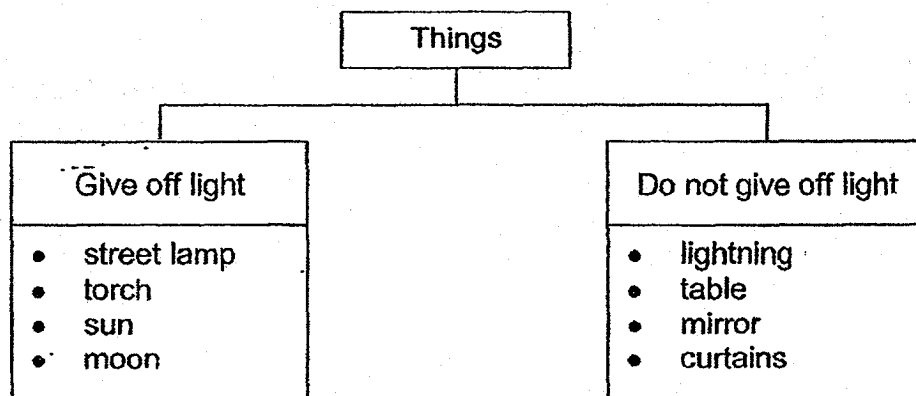

Based on the classification chart above, which of the following things has been classified **wrongly**?

- (1) sun and mirror
- (2) torch and moon
- (3) table and curtains
- (4) moon and lightning

16. 4 boys saw some stars in the sky at night.

Which one of the following statements they made is correct?

- (1) We are able to see the stars because they give out their own light.
- (2) We are able to see the stars because they reflect light from our eyes.
- (3) We are able to see the stars because they reflect light from the clouds.
- (4) We are able to see the stars because they take in light from the sun.

Study the diagram below and answer questions 17 and 18.
Lucas made a model igloo using lego bricks.

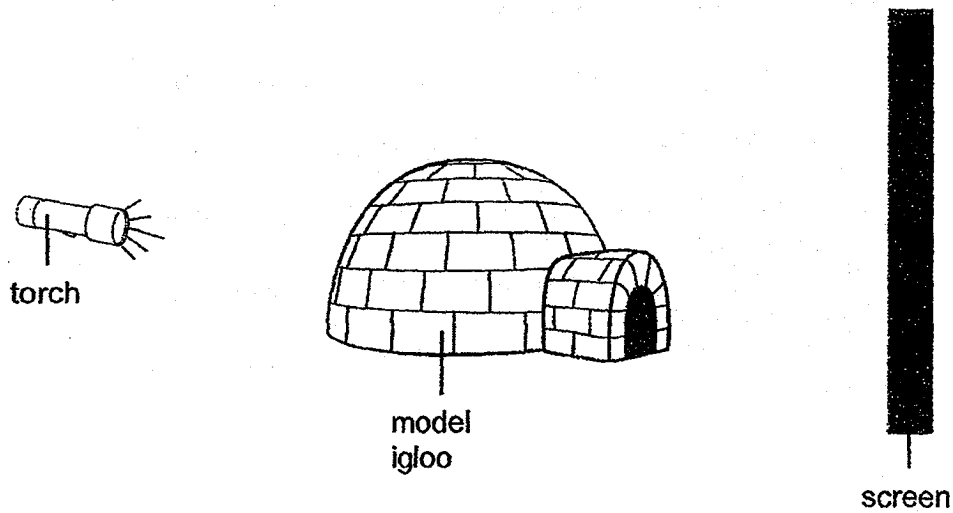

17. Lucas then shone his torch from the back of his model igloo to cast a shadow on the screen.

Which one of the following shows the shadow that Lucas could possibly see on the screen?

(1)

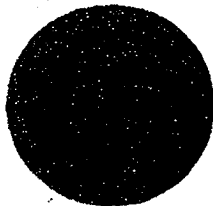

(2)



(3)



(4)



18. Lucas then moved the torch further away from the model igloo.

Which one of the following would happen to the shadow that is formed on the screen?

- (1) The shadow disappeared
- (2) The shadow became bigger.
- (3) The shadow became smaller.
- (4) The shadow remained the same.

19. Geraldine placed a sheet made of material Z in front of a mug as shown in the diagram below.

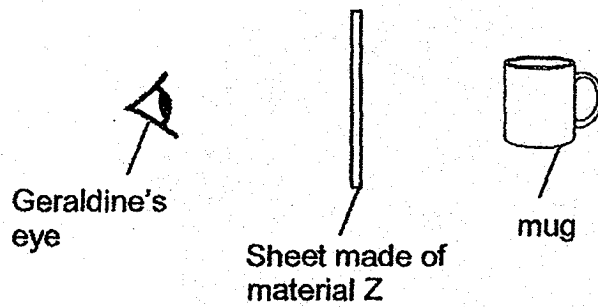

She saw a blurred outline of the mug through the sheet.

Which one of the following materials could Z be?

- (1) Ceramic
- (2) Clear plastic
- (3) Frosted glass
- (4) Aluminium sheet

20.

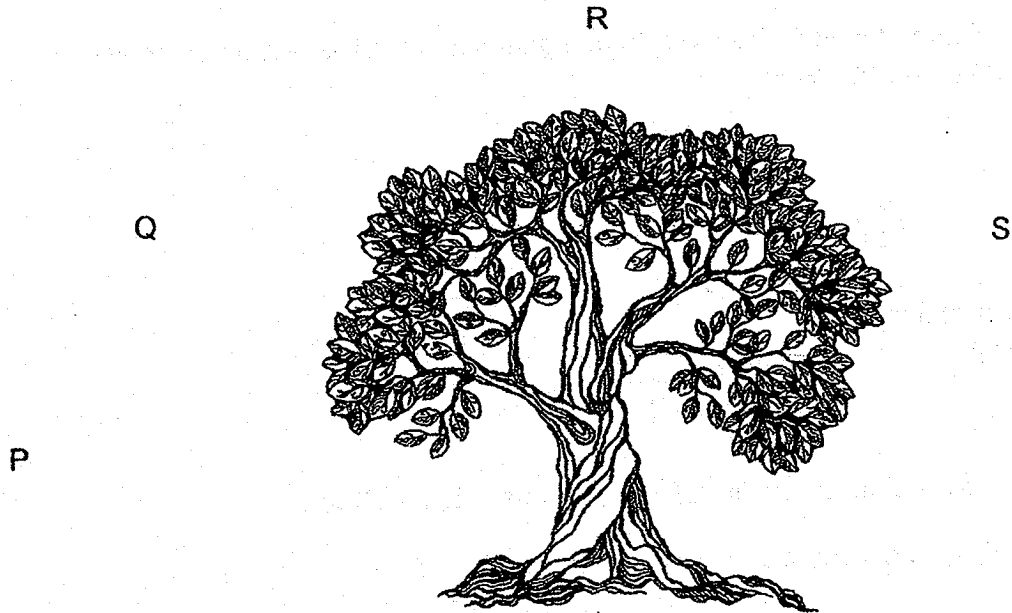

P, Q, R and S represent the positions of the Sun at different times of the day.

Which one of the following positions of the Sun would cause the shadow of the tree to be the shortest?

- (1) P
- (2) Q
- (3) R
- (4) S

21. Study the diagram shown below.

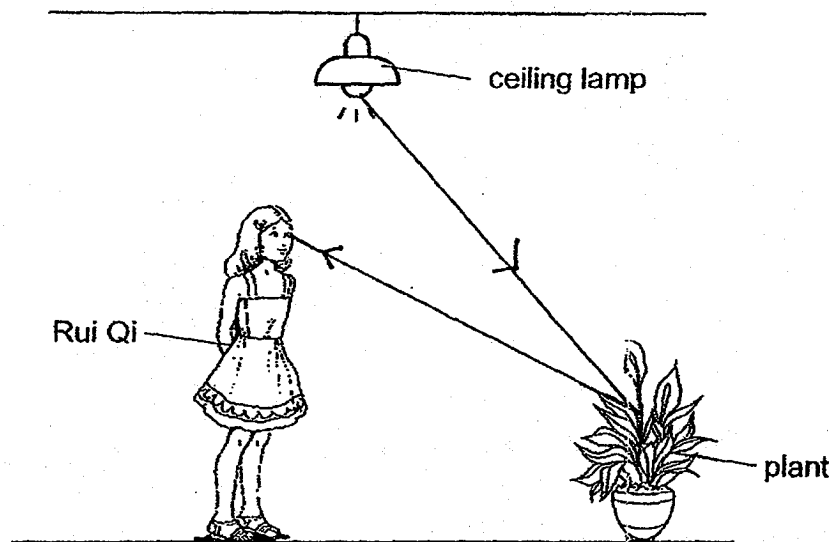

Rui Qi is standing under the ceiling lamp and she could see the plant when the ceiling lamp is turned on.

Which one of the following statements correctly explains the observation above?

- (1) The plant reflects the light from Rui Qi into the ceiling lamp.
- (2) Rui Qi reflects the light from the plant into the ceiling lamp.
- (3) Rui Qi reflects the light from the ceiling lamp into the plant.
- (4) The plant reflects the light from the ceiling lamp into the Rui Qi's eyes.

22. Ryan's mother placed a cake in a cardboard box.

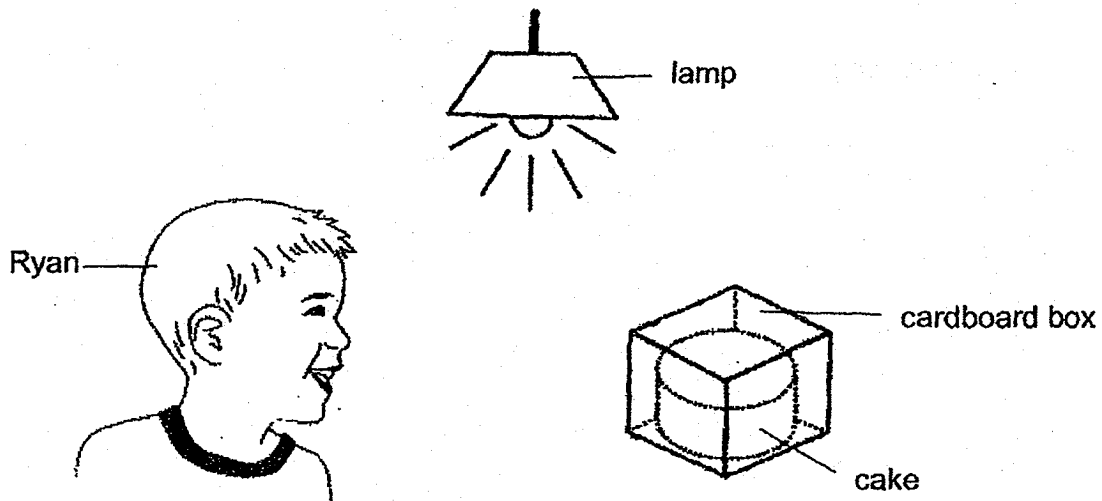

Which one of the following statements explains why Ryan **cannot** see the cake?

- (1) The cake does not give out enough light.
- (2) Light can pass through the cardboard box.
- (3) Light cannot pass through the cardboard box.
- (4) The cardboard box reflects light into Ryan's eyes.

23. Study the classification table below carefully.

Gas	Liquid	Solid
carbon dioxide oxygen shadow	milk oil water	ball cookie stone

Which one of the following is classified **wrongly**?

- (1) oil
- (2) milk
- (3) cookie
- (4) shadow

24. Grace conducted an experiment as shown below. She filled the syringe with 50cm^3 of substance Y and sealed it tightly. She pushed the plunger until it cannot be pushed further. She then observed that the volume of substance Y was reduced to 35cm^3 .

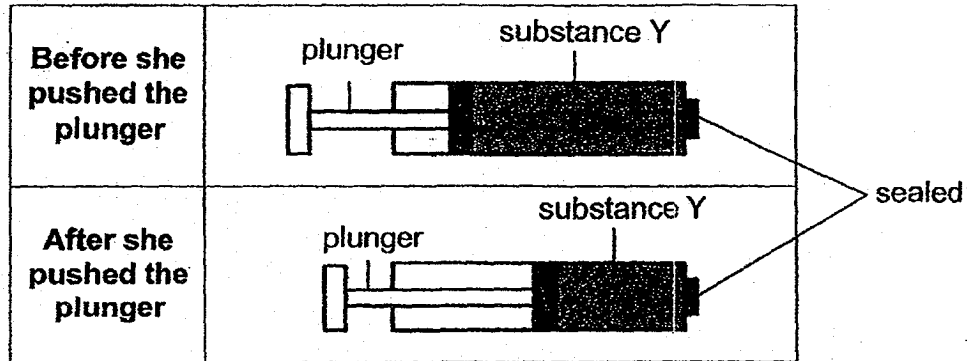

Based only on the experiment above, which of the following property/properties of substance Y can be concluded?

- A It has mass.
- B It occupies space.
- C It can be compressed.
- D It has a definite shape.

- (1) C only
- (2) B and C only
- (3) A, B and D only
- (4) A, C and D only

25. Samuel set up an experiment to compare the masses of four objects, A, B, C and D. He placed the objects on the lever balance as shown in the diagram below.

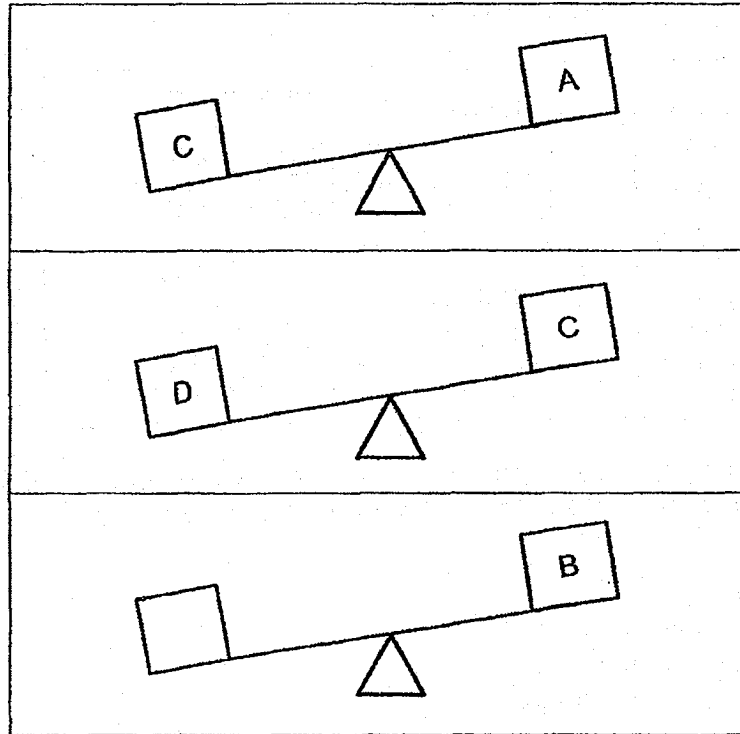

He then arranged the objects according to their masses.

Which of the following is the correct arrangement? ---

	Smallest mass → Biggest mass
(1)	B, A, C, D
(2)	B, C, A, D
(3)	D, A, C, B
(4)	D, C, A, B

26. The table below shows the characteristics of 3 substances, X, Y and Z. A tick (✓) shows that the substance has the characteristic.

Characteristic	Substance		
	X	Y	Z
has a definite shape			
has a definite volume			
can be compressed			

Which one of the following statement is true?

- (1) Substance X is a gas.
- (2) Substance Z is a liquid.
- (3) Substance X and Z are both liquids.
- (4) Substance Y is a gas and substance Z is a solid

27. Rebecca wants to find the volume of a pebble and a rod using a measuring cylinder. She set up the experiment as shown below.

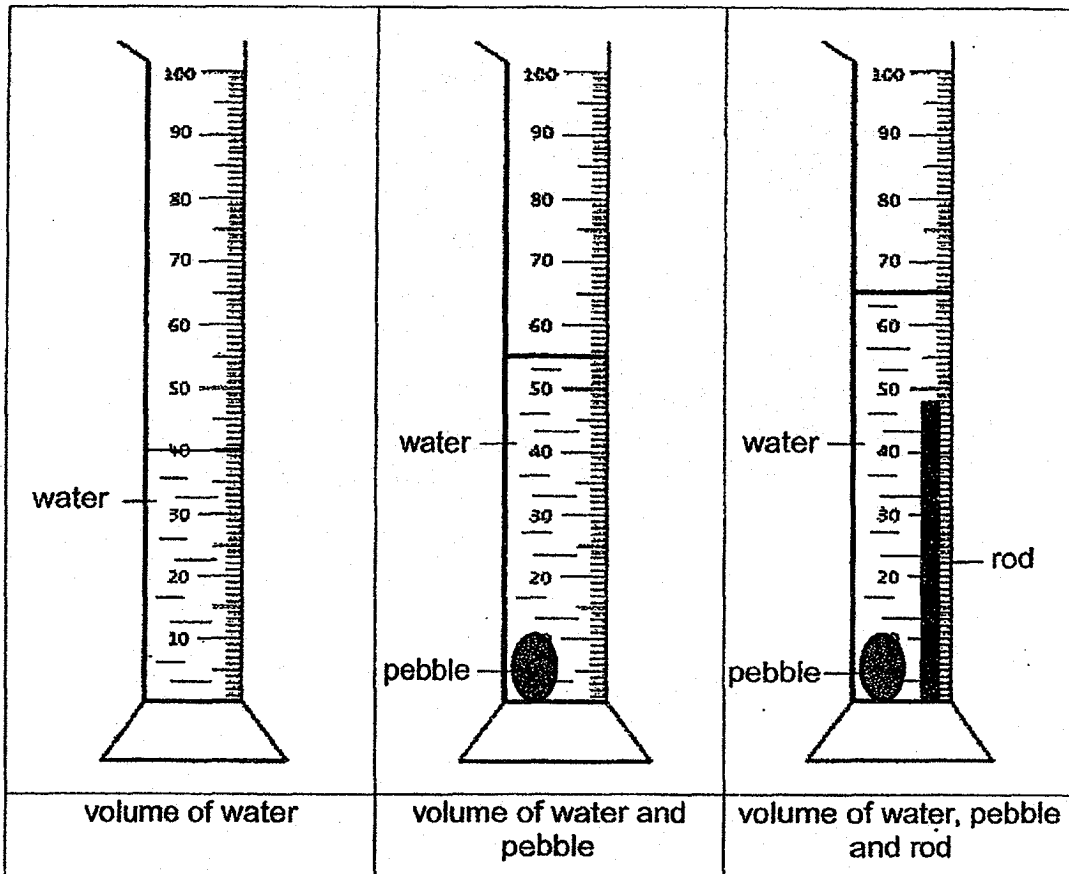

Based on the results from her experiment, what are the volumes of the pebble and the rod?

	volume of pebble (cm ³)	volume of rod (cm ³)
(1)	10	25
(2)	15	10
(3)	15	25
(4)	25	15

28. Monica set up an experiment as shown below. She filled a container with water and pushed an inverted plastic cup into the water in the container.

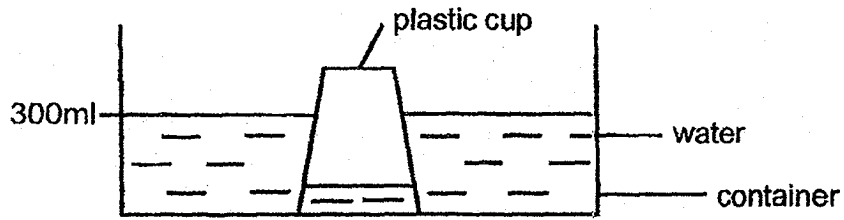

She then poked a hole at the top of the plastic cup with a needle.

Which one of the following shows the correct new water level in the cup?

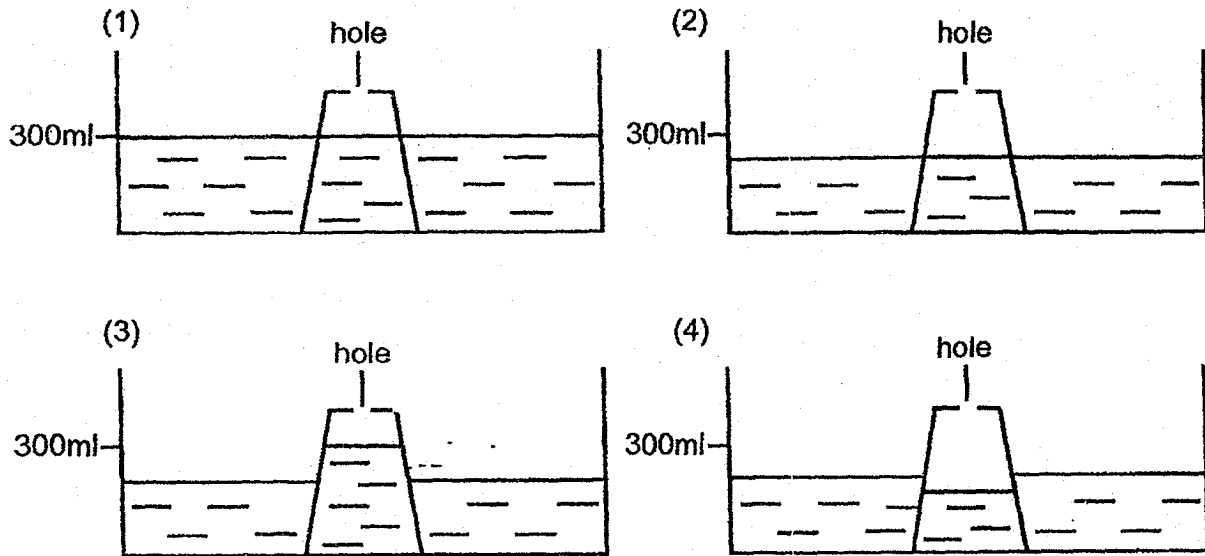

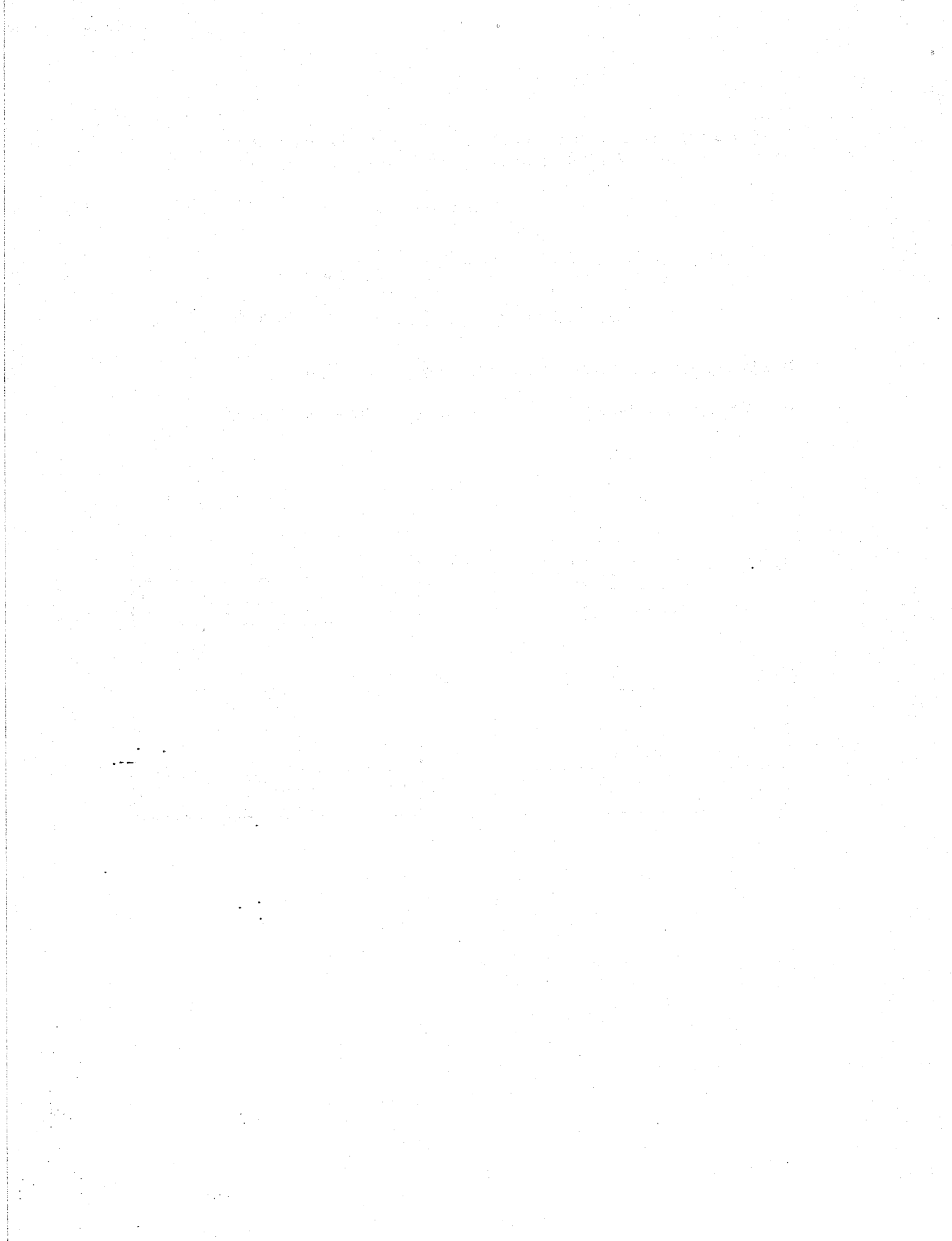

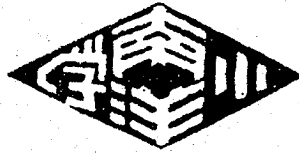

NANYANG PRIMARY SCHOOL

PRIMARY 4 SCIENCE

**SEMESTRAL ASSESSMENT 1
2018**

BOOKLET B

Date : 8th May 2018

Duration : 1 h 45 min

Name : _____ ()

Class: Primary 4 ()

Marks Scored:

Booklet A:		56
Booklet B :		44
Total :		100

Any query on marks awarded should be raised by 17th May 2018. We seek your understanding in this matter as any delay in the confirmation of marks will lead to delays in the generation of results.

Parent's signature:

**DO NOT OPEN THIS BOOKLET UNTIL YOU ARE TOLD TO DO SO.
FOLLOW ALL INSTRUCTIONS CAREFULLY.**

Booklet B consists of 17 printed pages including this cover page.

Section B (44 marks)

Write your answers to questions 29 to 40 in the spaces provided.

29. Mr Ng carried out an experiment as shown below. He put 3 similar plants into containers, A, B and C. A layer of oil was poured into each container to prevent any water loss.

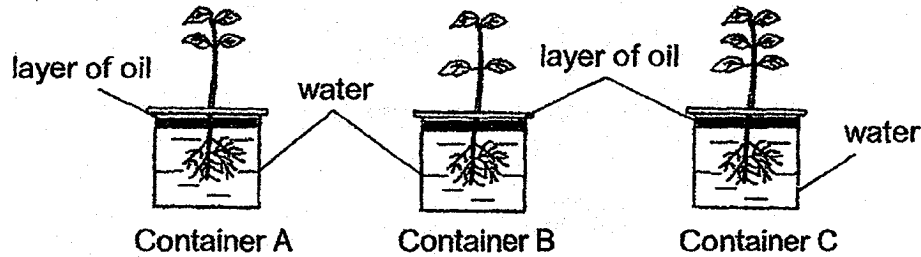

The volume of water in each container was measured after a week and recorded in the table below.

Container	Volume of water (ml)	
	Day 1	Day 7
A	200	175
B	200	190
C	200	160

- (a) Based on the results in the experiment above, state one characteristic of living things. [1]

- (b) Based on the experiment above, explain why the amount of water in Container C was the least after 7 days. [2]

- (c) Besides absorbing water and mineral salts, state one other function of roots. [1]

30. Study the table below.

Characteristics	Plant A	Plant B	Plant C	Plant D
Has flowers				
Has big leaves				
Has a weak stem				

- (a) Based on the table above, state a suitable heading for the classification chart below. [1]
- (b) Based on your headings in (a), classify plants A, B, C and D into the classification chart below. [2]

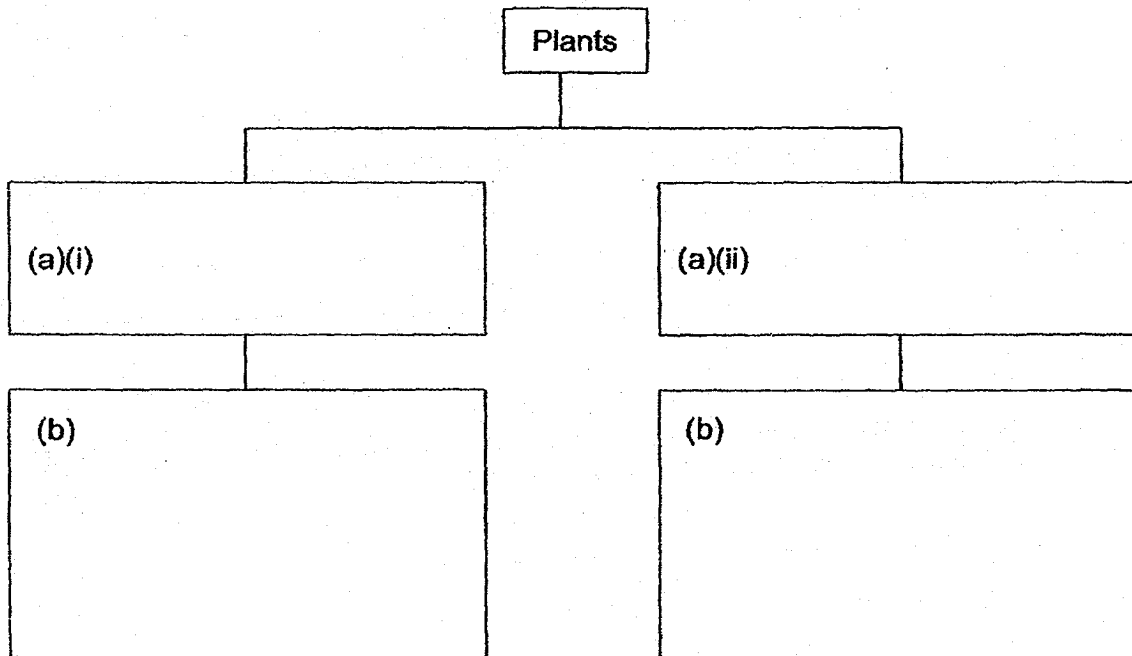

31. The table below shows the characteristics of animals A, B, C and D.

Characteristics	Animal A	Animal B	Animal C	Animal D
Lays eggs	Yes	Yes	No	Yes
Breathes through gills	No	Yes	No	No
Has wings	Yes	No	No	Yes
Has 3 body parts	Yes	No	No	No

- (a) John classified animal A as an insect.
Based on the characteristics of animal A in the table above, explain why he is correct. [1]

- (b) State another characteristic of animals that belong to the same group as animal A. [1]

- (c) Based on the table above, write A, B, C and D to identify the animals which best represents the animals below. [2]

goldfish	
monkey	
mosquito	
penguin	

32. The diagram shows two plants, A and B.

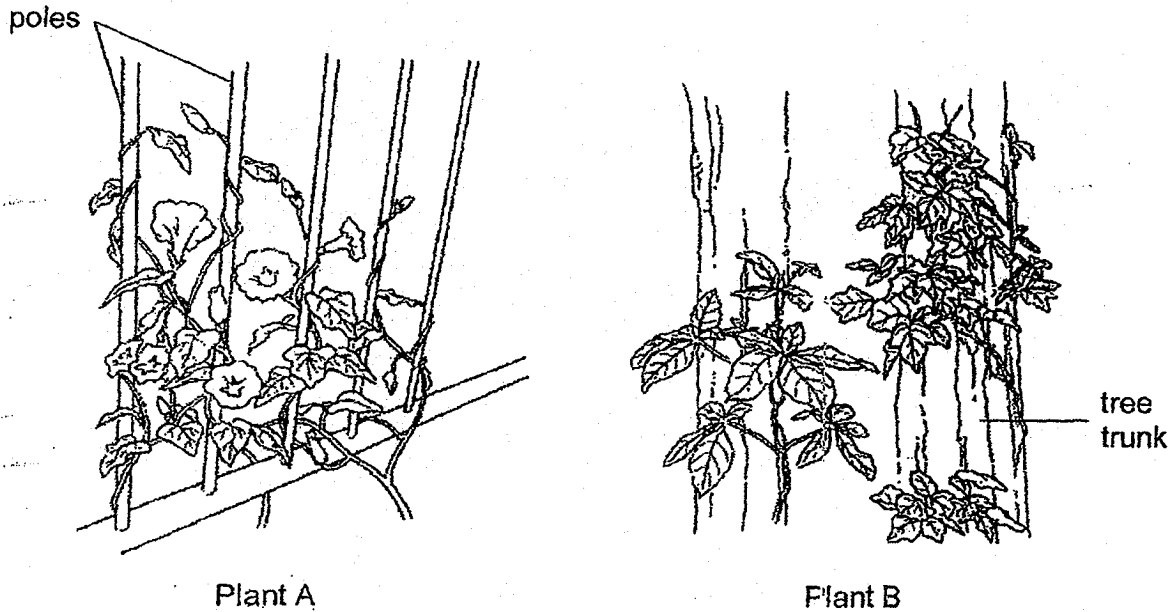

- (a) **Label** clearly the stem of plant A in the diagram above. [1]
- (b) How are the stems of plants A and B similar? [1]
-
- (c) Explain how the poles and the tree trunk help plants A and B get more sunlight to make food. [1]
-

33. The diagrams below represent 3 human organ systems.

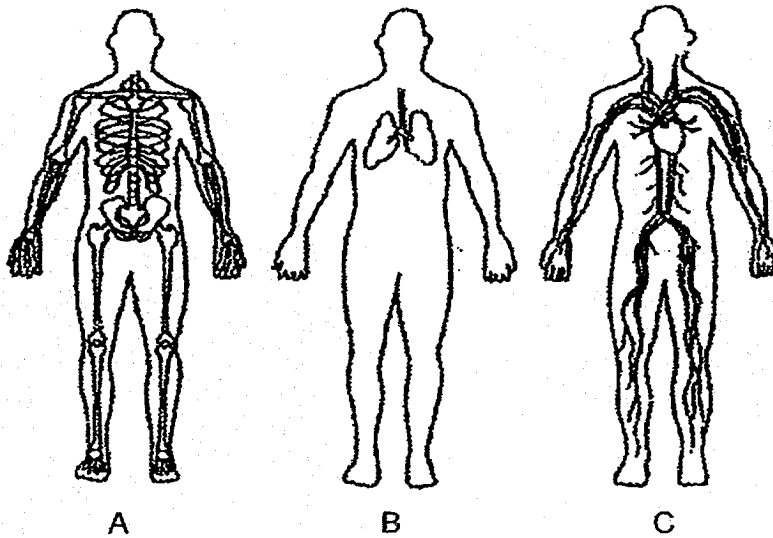

(a) (i) Which one of the above organ systems, A, B or C, work with the muscular system to enable us to move? [1]

(ii) Identify the human organ system that you have chosen in (a)(i). [1]

(Continue from Question 33)

En Jie ate 50 grams of fried chicken for lunch. The graph below shows the amount of undigested food leaving the four different parts of En Jie's digestive system.

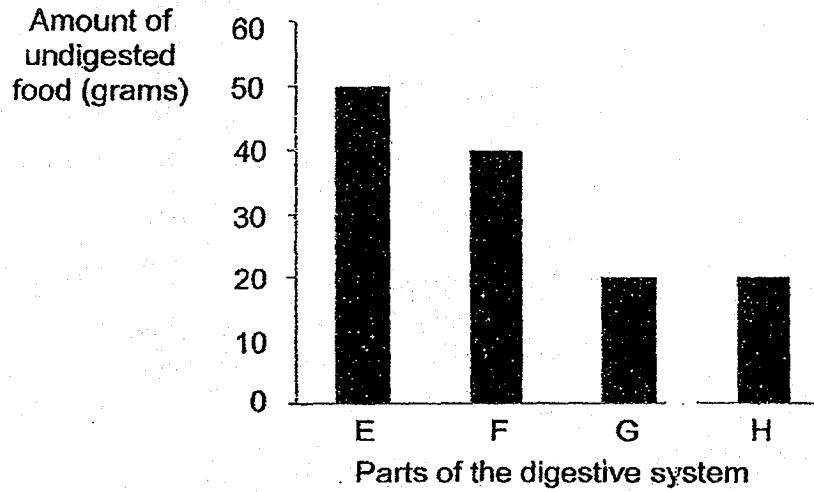

- (b) Based on the graph above, which part(s) of the digestive system, E, F, G or H, does/do digestion take place? Explain your answer using the data from the graph above. [2]

34. Mei Ling set up an experiment as shown below.

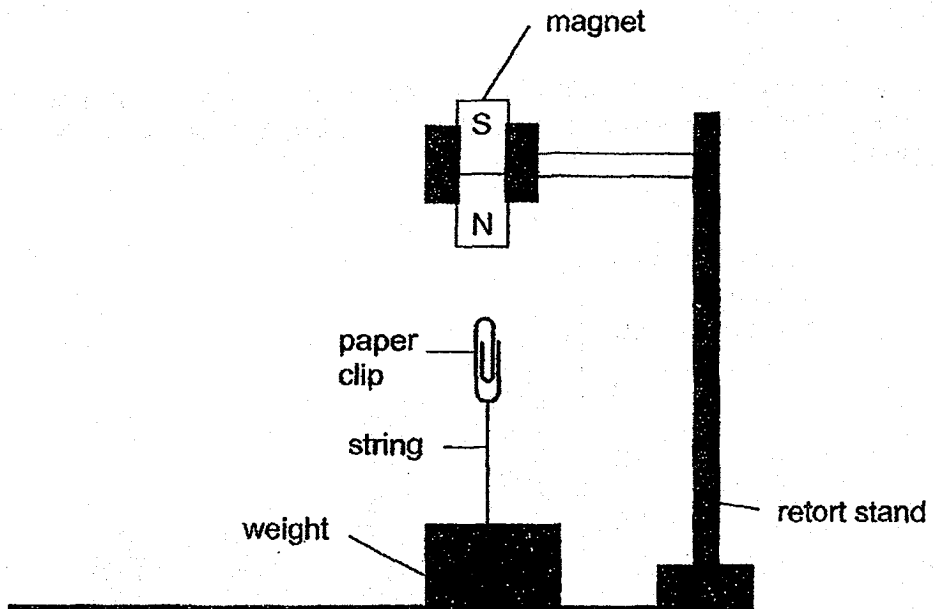

(a) Explain why the paper clip is able to "float" in the air. [2]

(b) State a possible material of the paper clip. [1]

(Continue from Question 34)

Mei Ling saw a "floating" toy with two ring magnets which pass through a smooth plastic rod as shown below.

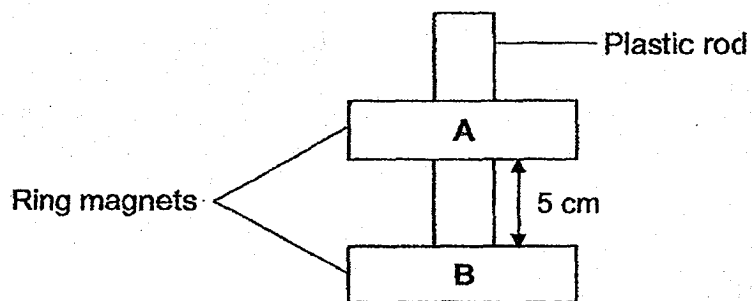

(c) State a property of magnets which is shown in the diagram above. [1]

Mei Ling replaced magnet A with magnet C. She observed that the distance between magnets B and C became greater.

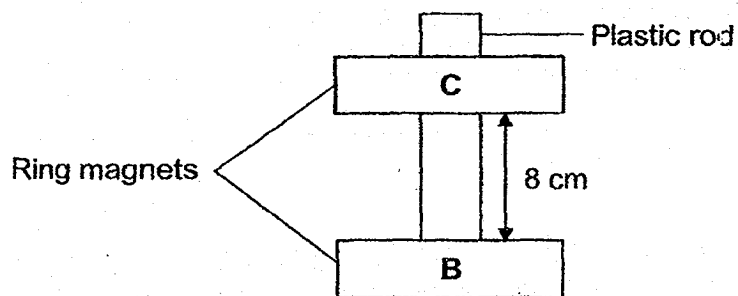

(d) Explain her observation. [1]

35. Colin set up an experiment as shown in the diagram below.

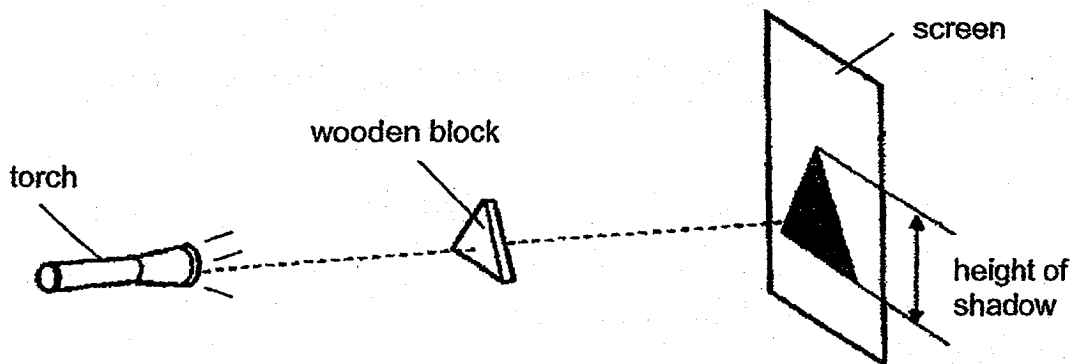

He moved the wooden block away from the screen and recorded the height of the shadow formed in the table below.

Distance between the wooden block and the screen (cm)	Height of the shadow (cm)
2	11
4	12
6	13

(a) Explain how the shadow of the wooden block is formed. [1]

(b) Based on the table above, what would happen to the height of the shadow when Colin increased the distance between the wooden block and the screen? [1]

(c) If the positions of the wooden block and screen are fixed, suggest one way Colin can increase the height of the shadow using the same set-up as shown above. [1]

36. The classification chart below shows four different materials, A, B, C and D.

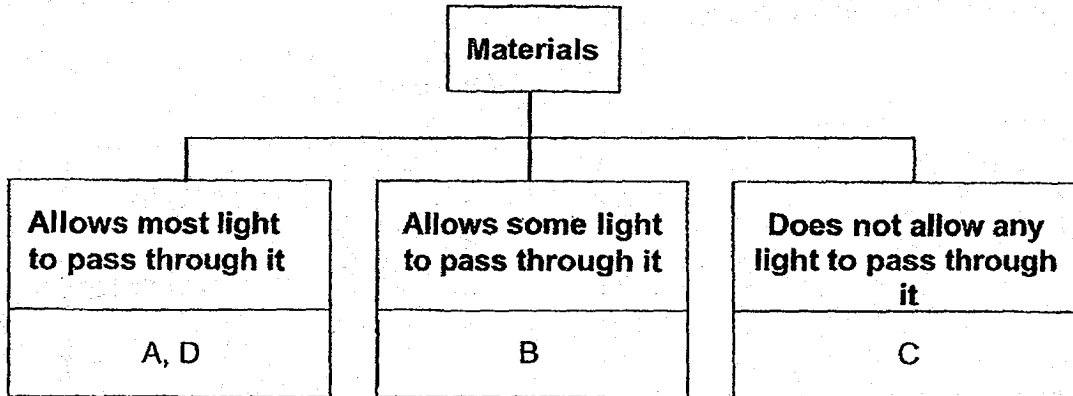

Mr Tan used each of these materials to build four walls of the same thickness to divide his playroom into 4 equal cubicles. Each material was used **once**.

Mr Tan's children stood in the 4 cubicles and observed the following:-

- i) Faith and Xavier could not see each other.
- ii) Xavier and Jia Kai could see each other clearly.
- iii) Sophie and Faith could see a blurry outline of each other.
- iv) Sophie and Jia Kai could see each other clearly.

Based on the information above, identify the materials used for building each wall and write the letters, A, B, C and D, in each of the boxes below. Each letter can only be used **once**. [2]

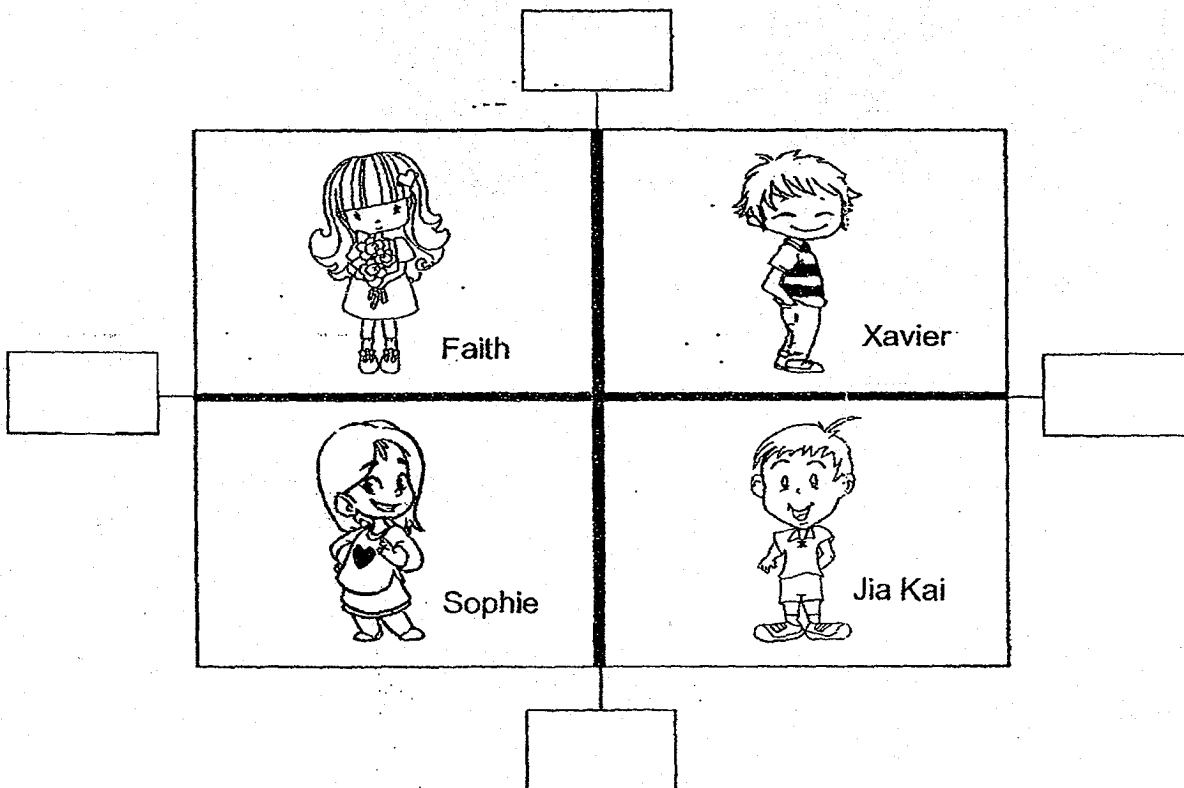

37. Kyan conducted an experiment using 2 identical lit light bulbs as shown in Set-ups A and B below. He used a light sensor to measure the amount of light given out by each of the light bulb.

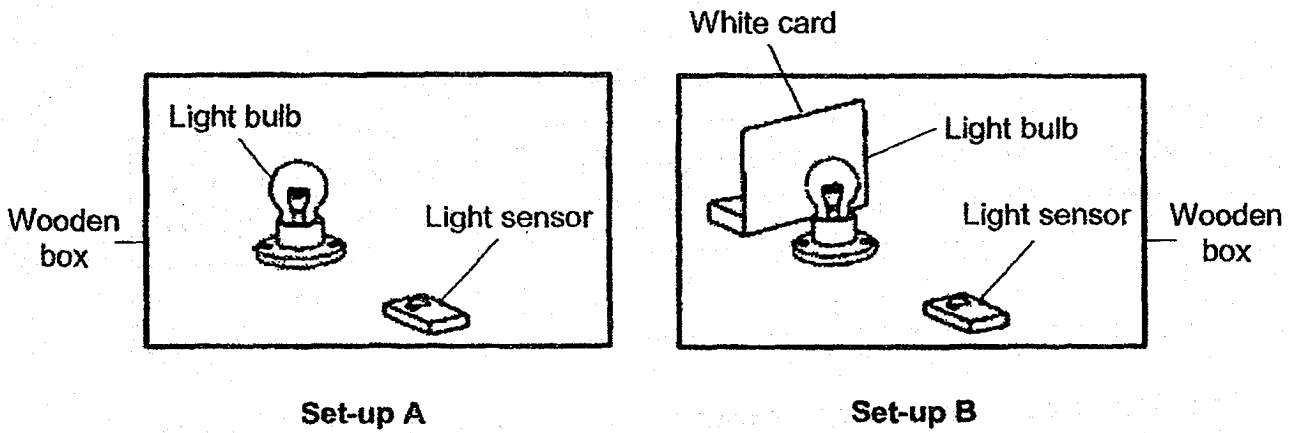

He showed the results of his experiment in the bar graph below.

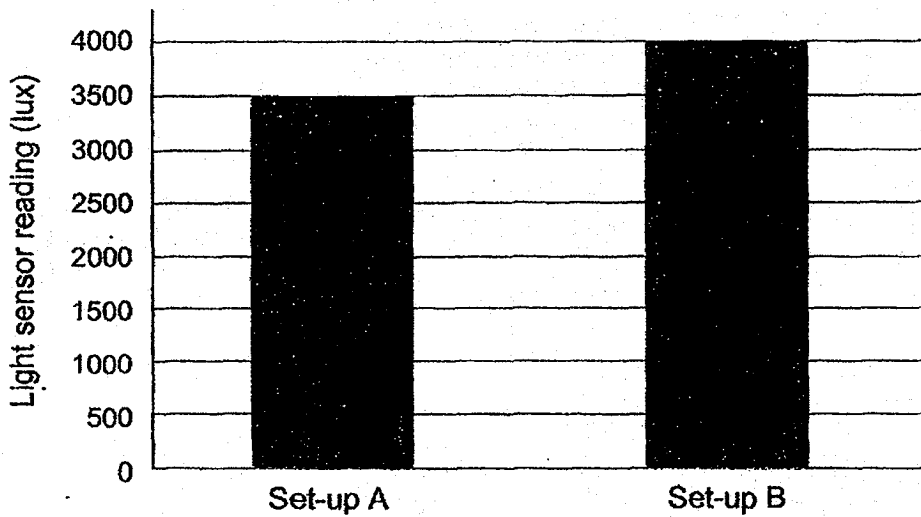

- (a) Explain the results observed above. [2]

(Continue from Question 37)

The diagram below shows a man working along the road

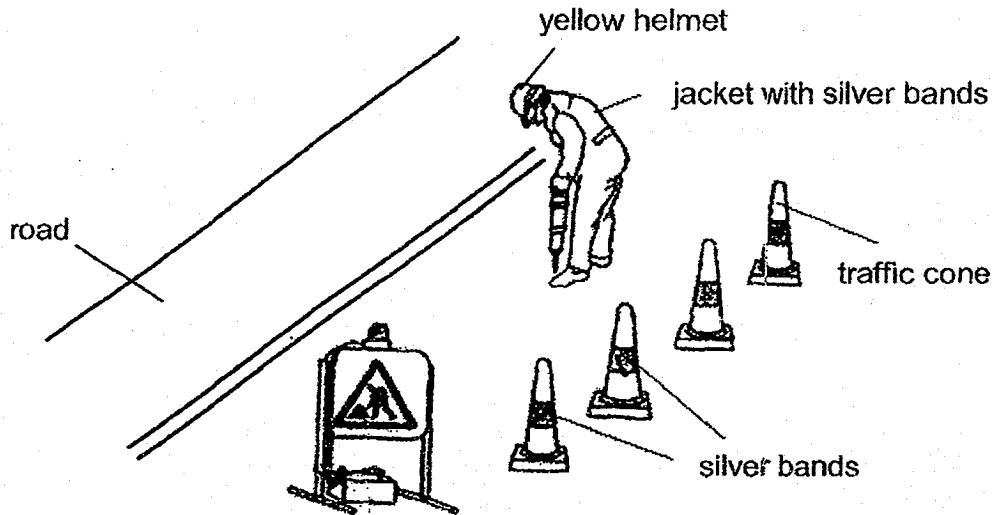

- (b) During the day, the man wears a yellow helmet when he is working along the road. Explain how the car driver can see the yellow helmet from a distance. [1]

During the night, silver bands on the cones and the man's jacket ensure that car drivers can see him better when he is working along the road.

- (c) Explain how having the silver bands help car drivers see the man and the traffic cones better at night when the car headlights shine on them. [1]

38. Study the flowchart below.

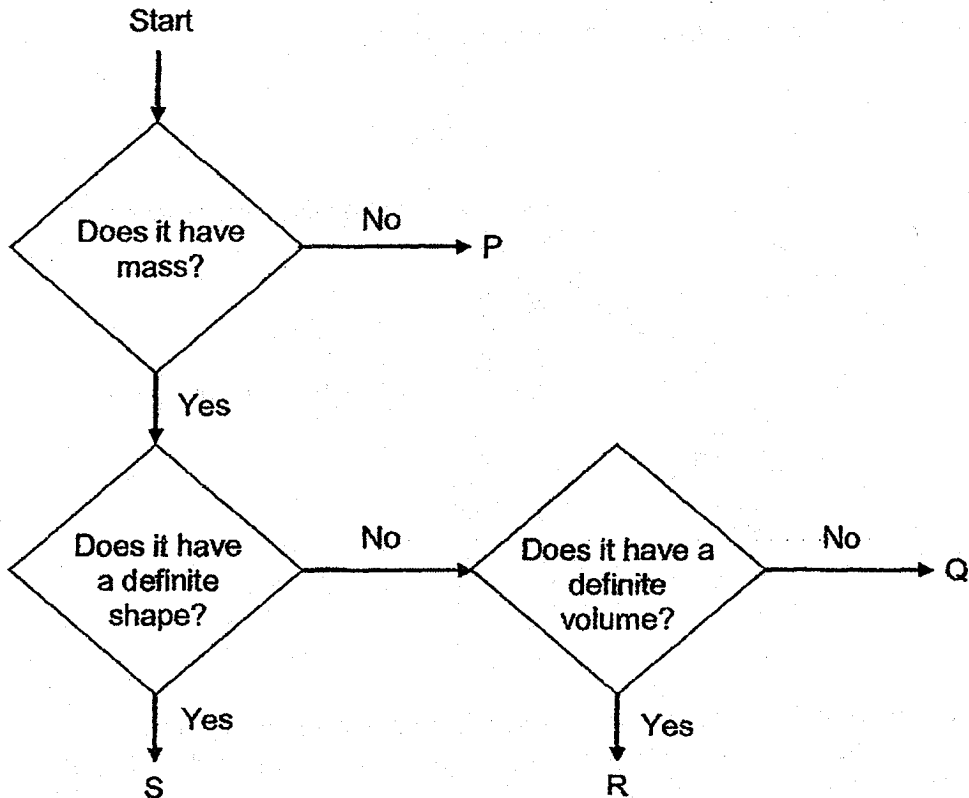

(a) Based on the flowchart above, state all the properties of substance S. [1]

(b) Based on the flowchart above, state the difference between substance R and Q. [1]

(c) State an example of P [1]

39. Study the classification chart below carefully.

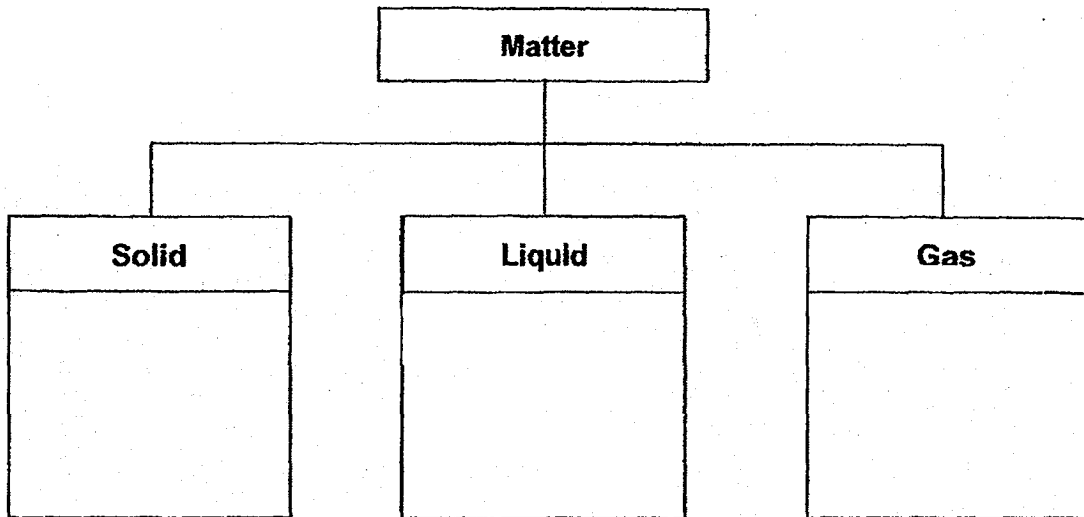

(a) Classify all the following objects into the chart above. [2]

air	oil	pencil	sand
-----	-----	--------	------

Cheryl placed an iron block in a container as shown below.

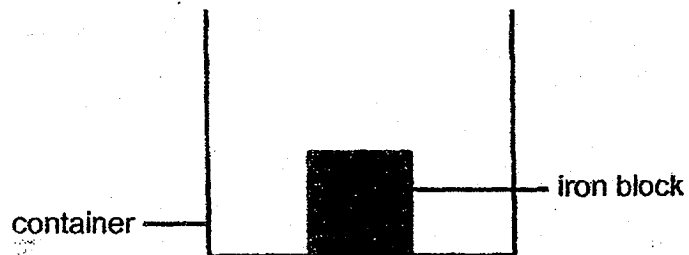

(b) (i) Identify the state of matter that the iron block is in. [1]

(ii) Based on the observation above, explain your answer in (b)(i). [2]

40. Sandra set up an experiment as shown below. She filled a beaker with 100cm^3 of water. She then placed a 40g ball of plasticine into the beaker of water.

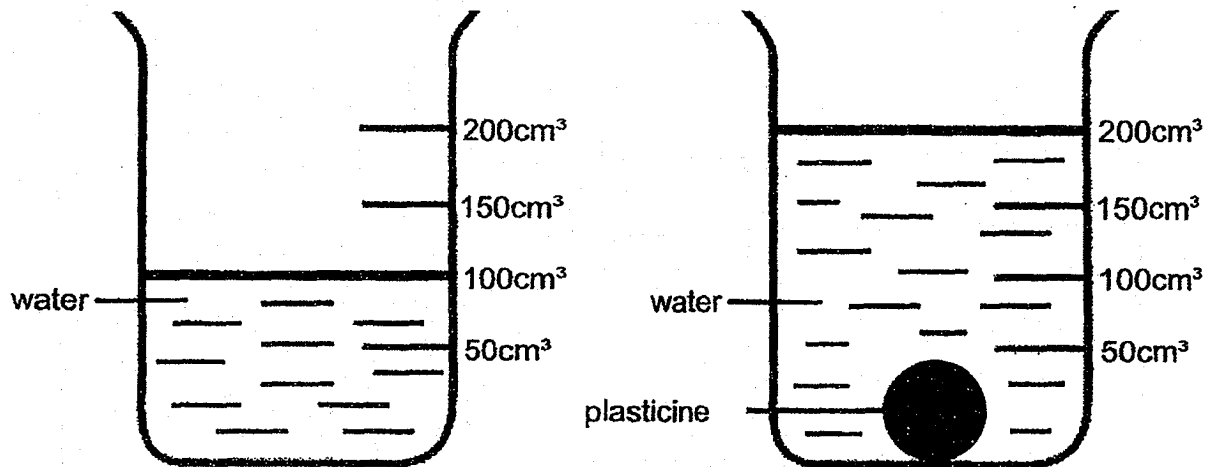

- (a) (i) What is the volume of the ball of plasticine? [1]

_____ cm^3

- (ii) Based on the results above, state a property of the plasticine. [1]

(Continue from Question 40)

Cheryl then cut the ball of plasticine into 2 equal pieces and placed them back into the **same beaker of water**.

(b) (i) In the diagram below, **draw a line** to indicate the water level of the beaker of water. [1]

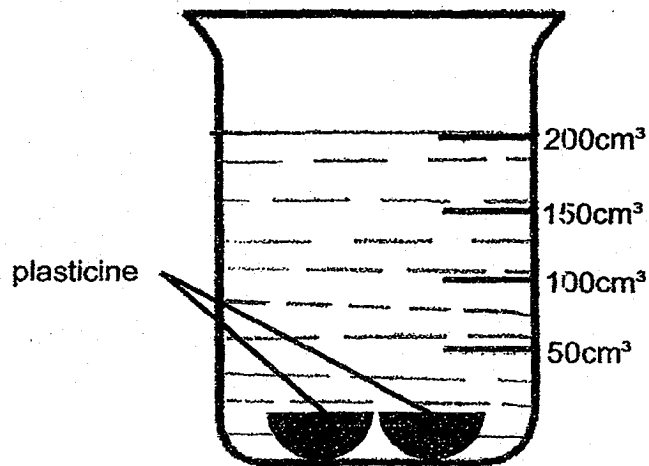

(ii) Explain your answer in (b)(i). [1]

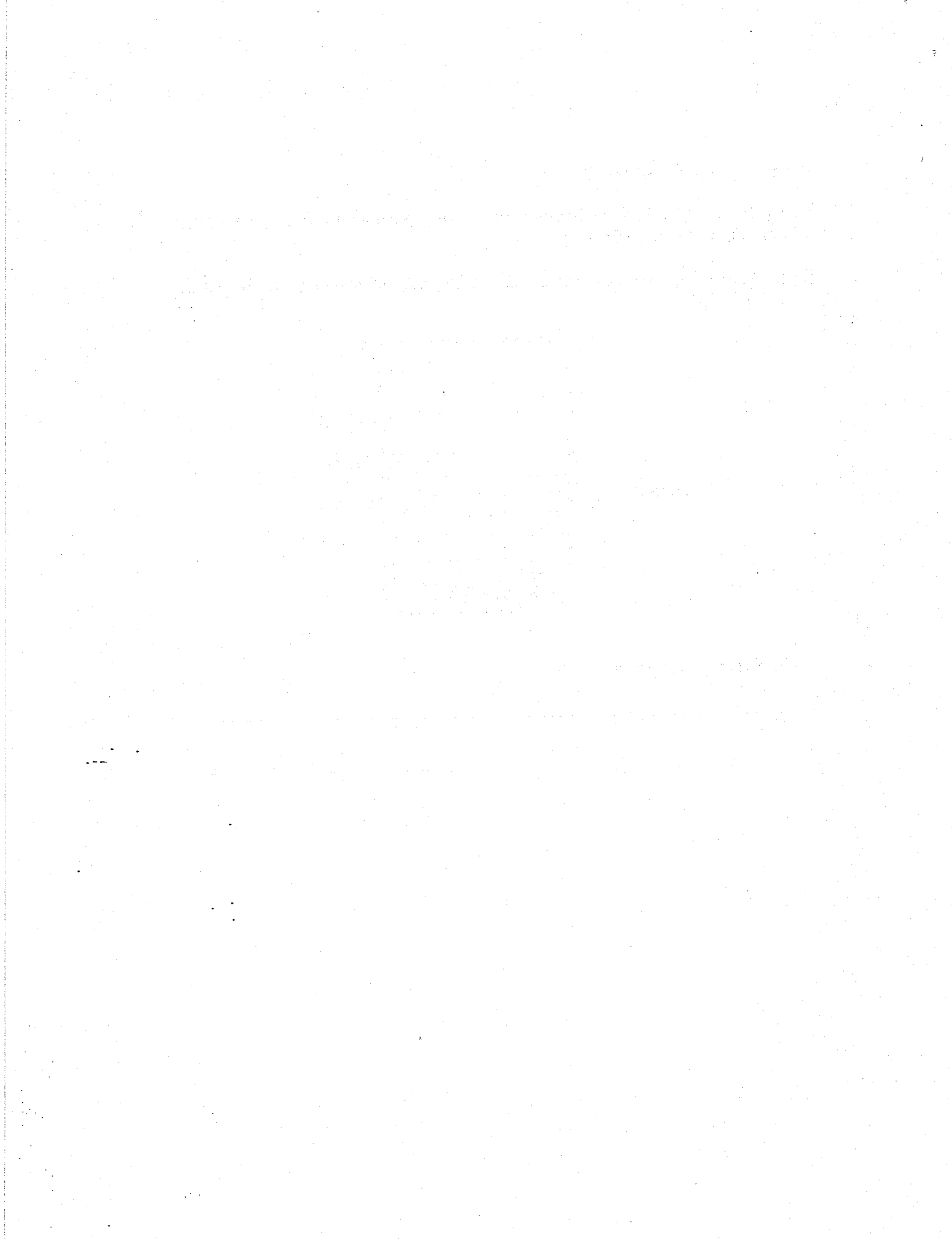

ANSWER KEY

YEAR : 2018
LEVEL : PRIMARY 4
SCHOOL : NANYANG PRIMARY SCHOOL
SUBJECT : SCIENCE
TERM : SA1
BOOKLET A

Q1	Q2	Q3	Q4	Q5	Q6	Q7	Q8	Q9	Q10
1	4	3	3	4	1	2	4	4	2
Q11	Q12	Q13	Q14	Q15	Q16	Q17	Q18	Q19	Q20
4	2	3	3	4	1	2	3	3	3
Q21	Q22	Q23	Q24	Q25	Q26	Q27	Q28		
4	3	4	2	1	4	2	2		

BOOKLET B

Q29a) Living things need water to survive.

b) It takes in the most water because it has the most leaves to make the food for the plant.

c) It holds the plant firmly to the ground.

Q30)

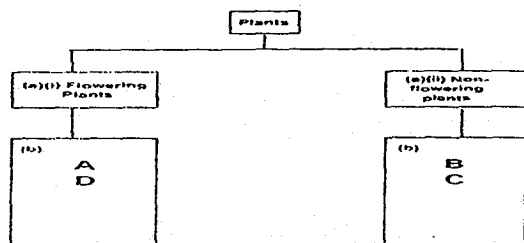

Q31a) Animal A has 3 body parts and only insects have 3 body parts , thus it is an insect.

b) They have 3 pair of legs .

c)

Goldfish	B
Monkey	C
mosquito	A
penguin	D

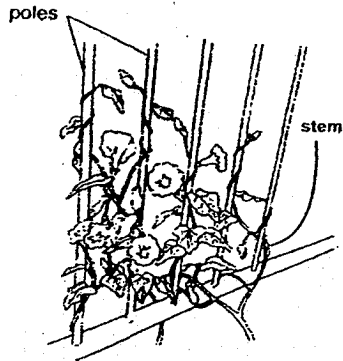

Plant A

Q32a)

- b) Both stems of plant A and B are weak.
- c) It supports the stem of plant A and B so that the stems can hold the leaves up and get sunlight to make food.

Q33a)i) A

ii) Skeletal system

- b) Part E to F, the amount of undigested food decreased from E to F. From F to G, the amount of undigested food decreased.

Q34a) It is made of a magnetic material which can be attracted to a magnet but the string is holding it back.

b) Iron

c) The like poles of the magnet repels.

d) Magnet C had a stronger magnetic strength than magnet A so it is attracted over a longer distance.

Q35a) The shadow of the wooden block is formed when it blocks light from passing through since light travels in a straight line a shadow is casted on the screen.

b) The height of the shadow would increase when colin increased the distance between the wooden block and the screen.

c) He could move the torch closer to the wooden block.

Q36

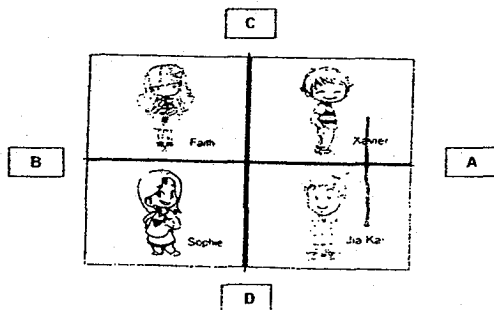

Q37a) The white card in set-up B reflects light into the light sensor, hence the light sensor detects more light in set-up B.

b) The yellow helmet would reflect light into the car driver's eyes.

c) The silver band reflects more light into the car driver's eyes when the headlights shine on them.

Q38a) Substance S has mass and has a definite shape.

b) Substance R has a definite volume but substance Q does not have a definite volume.

c) Shadow.

Q39a)

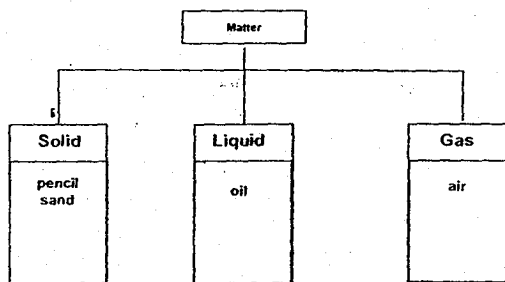

b)i) solid

ii) The iron block is a solid so it has a definite shape and does not take the shape of the container.

Q40a)i) 100 cm^3

ii) The plasticine has volume.

b)i)

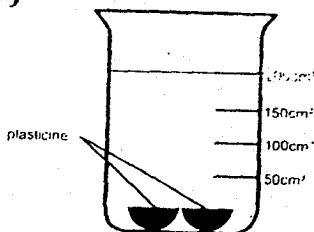

ii) Although cut in half, the plasticine still has the same amount of volume so the water level will be the same.

THE END

