



HENRY PARK PRIMARY SCHOOL
FIRST SEMESTRAL ASSESSMENT 2018
PRIMARY 4
SCIENCE
BOOKLET A (56 MARKS)

INSTRUCTIONS TO CANDIDATES

1. Do not turn over this page until you are told to do so.
2. Follow all instructions carefully.
3. Answer all questions.
4. Shade your answers on the Optical Answer Sheet (OAS) provided.

Name: _____ ()

Class: Primary 4 ()

Date: 14 May 2018

Total Time for Booklets A & B: 1 h 45 min

Booklet	Marks
A	/ 56
B	/ 44
Total (A+B)	/ 100

Parent's Signature: _____

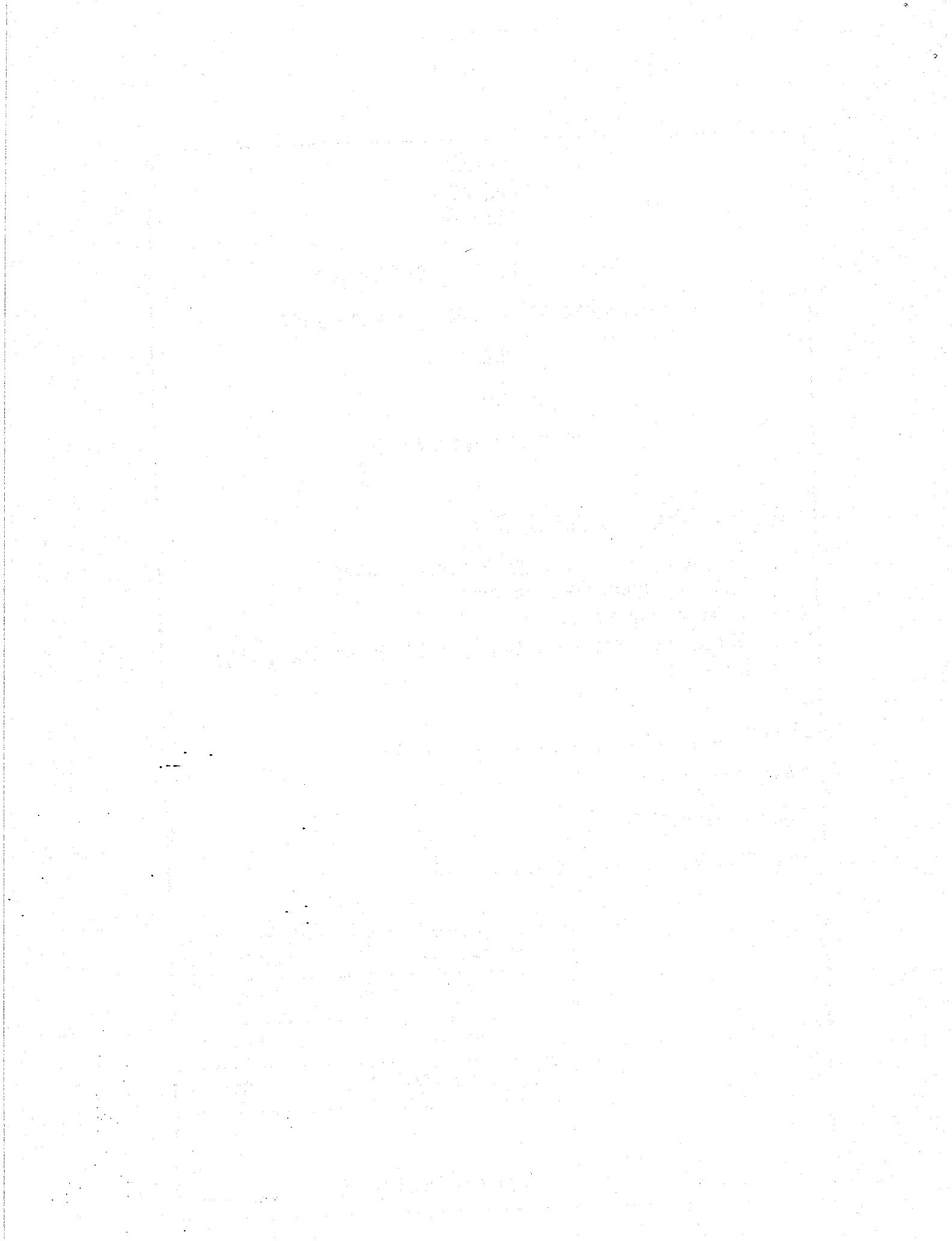

Section A (56 marks)

For each question from 1 to 28, four options are given. One of them is the correct answer. Make your choice (1, 2, 3 or 4). Shade the correct oval (1, 2, 3 or 4) on the Optical Answer Sheet.

1. Which of the following statements about plants are correct?

A: Some plants have weak stems.

B: The stem holds the plant firmly to the soil.

C: A plant grows well when each plant part functions properly.

(1) A and B only

(2) A and C only

(3) B and C only

(4) A, B and C

2. Which one of the following is correct?

	Organ involved in digestion of food	Organ involved in the absorption of food
(1)	mouth	gullet
(2)	gullet	stomach
(3)	stomach	small intestine
(4)	small intestine	large intestine

3. The diagram below shows a floating water plant.

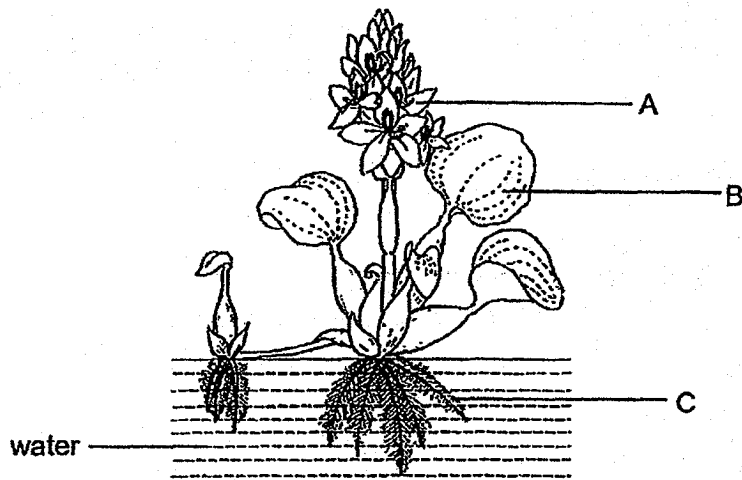

Which of the following correctly shows the function of the parts of the plant?

	makes food	absorbs water
(1)	A	B
(2)	B	A
(3)	B	C
(4)	C	A

4. Which of the following have mass and occupy space?

- (1) apple and ink
- (2) marble and heat
- (3) apple and heat
- (4) ink and shadow

5. The diagram below shows how food travels in the human digestive system.

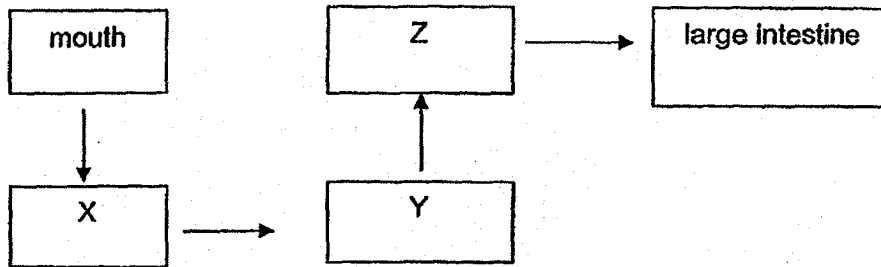

Based on the diagram, which of the following is correct?

	small intestine	stomach
(1)	X	Y
(2)	Z	Y
(3)	Y	Z
(4)	Y	X

6. Which one of the following is not a source of heat?

- (1) A book
- (2) The Sun
- (3) A lighted match
- (4) A burning candle

7. Which of the following best represents matter in gaseous state?

	Can be compressed	Has a fixed shape
(1)	Yes	No
(2)	Yes	Yes
(3)	No	No
(4)	No	Yes

8. The diagram below shows a beaker containing two substances, A and B.

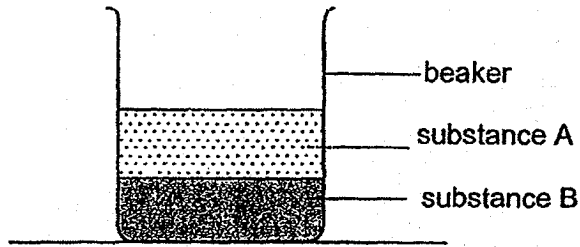

The beaker was then put on a wooden wedge, as shown below.

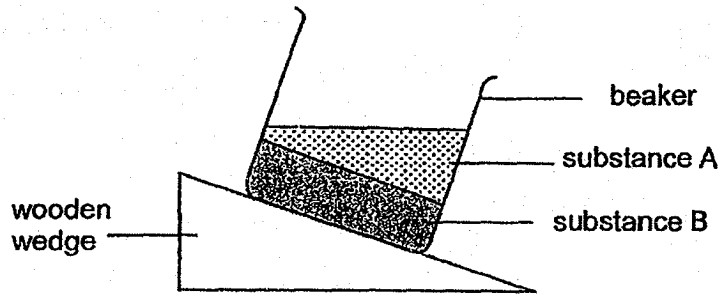

Which states of matter are substances A and B likely to be?

	A	B
(1)	gas	solid
(2)	gas	liquid
(3)	liquid	liquid
(4)	liquid	solid

9. Which of the following containers of water has the most amount of heat?

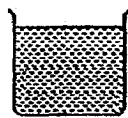

Water at
70°C

(1)

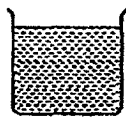

Water at
90°C

(2)

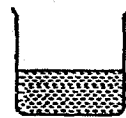

Water at
70°C

(3)

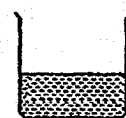

Water at
90°C

(4)

10. Jayden poured 25 ml of water into each of the three measuring cylinders. He then placed three different objects, X, Y and Z, into the measuring cylinders as shown in the diagram below.

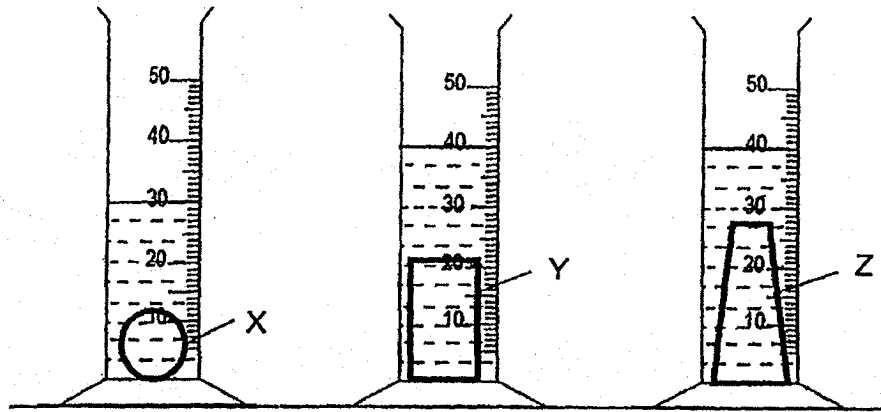

Based on his observations, which of the following conclusions are correct?

- A: Object Z has the largest volume.
- B: Objects Y and Z have the same volume.
- C: Object Y has a greater volume than Object X.

- (1) A and B only
- (2) A and C only
- (3) B and C only
- (4) A, B and C

11. Joseph and his brother were playing table tennis. Joseph accidentally stepped on the table tennis ball as shown in the diagram below.

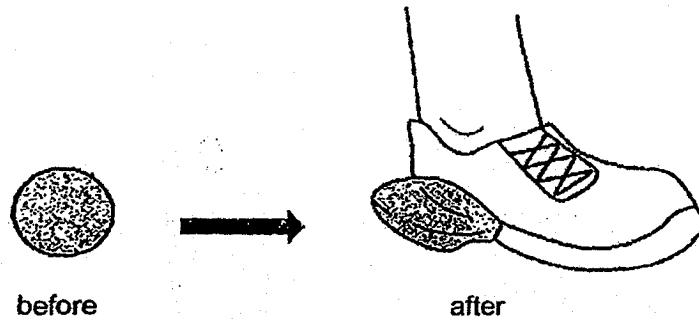

Based on the information given, which of the following is correct after Joseph stepped on the table tennis ball?

	Shape of the table tennis ball	Mass of the table tennis ball
(1)	changes	increases
(2)	changes	remains the same
(3)	remains the same	decreases
(4)	remains the same	remains the same

12. The table below shows some properties of three objects A, B and C at room temperature.

Properties	Object A	Object B	Object C
Has a definite shape	Yes	No	No
Has a definite volume	Yes	Yes	No

Which of the following correctly represents objects A, B and C?

	Object A	Object B	Object C
(1)	oil	stone	oxygen
(2)	stone	oxygen	oil
(3)	stone	oil	oxygen
(4)	oil	oxygen	stone

13. The diagram below shows a pump connected to a glass jar with a capacity of 300 cm^3 .

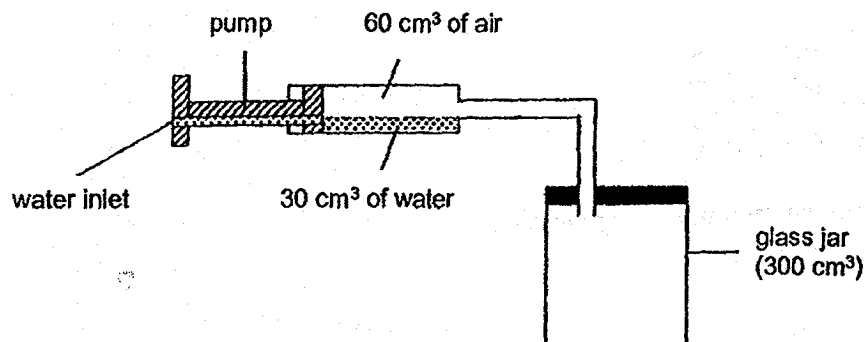

When the pump is pushed completely in, 30 cm^3 of water and 60 cm^3 of air is forced into the jar.

What is the volume of the air in the jar?

- (1) 60 cm^3
- (2) 270 cm^3
- (3) 330 cm^3
- (4) 360 cm^3

14. Study the classification table below.

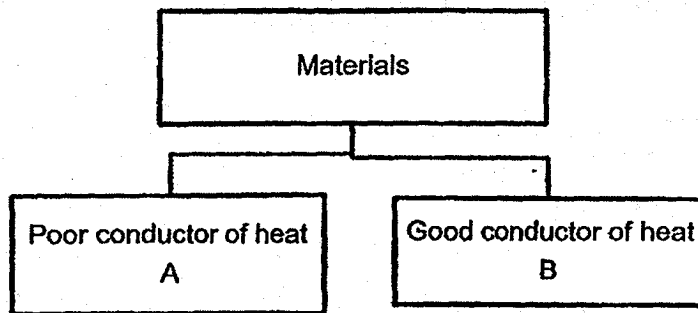

Which of the following could materials A and B be?

	A	B
(1)	Steel	Aluminium
(2)	Paper	Wood
(3)	Cloth	Plastic
(4)	Ceramic	Copper

15. When we add ice cubes to hot milo, the hot milo _____ heat to the ice cubes and its temperature _____.

- (1) gains, falls
- (2) gains, rises
- (3) loses, falls
- (4) loses, rises

16. The diagram below shows a frying pan.

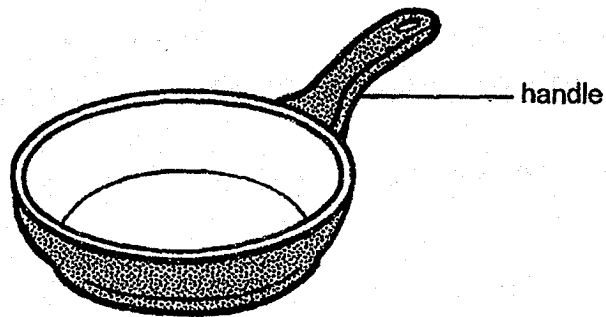

The frying pan is made up of iron and plastic.

Why is the handle of the frying pan made of plastic?

- (1) Plastic is light.
- (2) Plastic is flexible.
- (3) Plastic is a poor conductor of heat.
- (4) Plastic is a good conductor of heat.

17. A cup of cold water at 5°C was left on a table with a room temperature of 28°C .

What would be the likely temperature of the cup of cold water after six hours?

- (1) 0°C
 - (2) 5°C
 - (3) 28°C
 - (4) 90°C
18. Joshua keeps himself warm by sitting near a fire as shown in the diagram below.

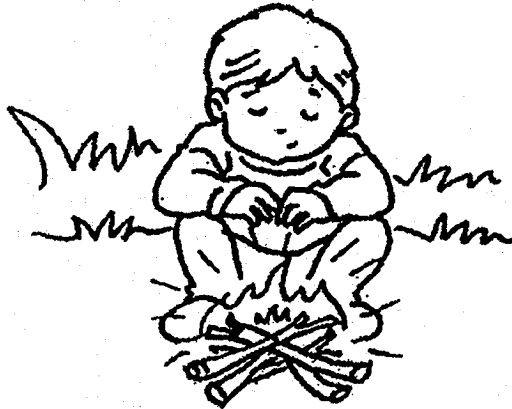

Which of the following best explains why he feels warm around the fire?

- (1) His body loses heat to the fire.
- (2) His body gains heat from the fire.
- (3) His body gains heat from the wood.
- (4) His body loses heat to the surrounding air.

19. Which of the following are examples of water gaining heat?

- A: A cup of ice melting
- B: A pot of water boiling
- C: A cup of water in a freezer

- (1) A and B only
- (2) B and C only
- (3) A and C only
- (4) A, B and C

20. John placed two similar 5 kg metal blocks on two similar stools made of different materials. Within a few minutes, he observed that stool P broke as shown in the diagram below.

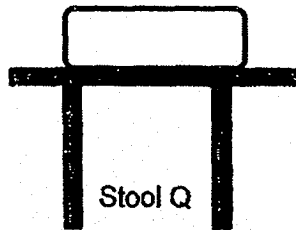
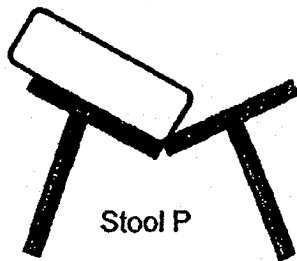

After that, he placed two similar 10 kg metal blocks on stool Q and another similar stool, R, made of a different material. Within a few minutes, he observed that stool Q broke as shown in the diagram below.

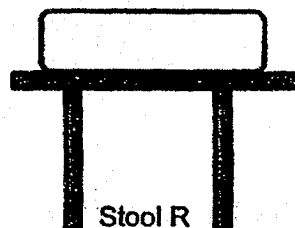
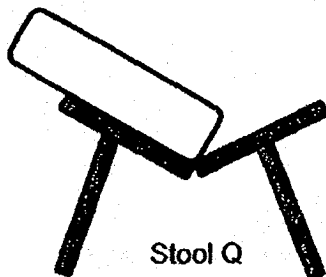





What conclusions can John make based on his observations?

- A: Stool Q is made of the strongest material.
- B: Stool Q is made of a stronger material than stool P.
- C: Stool R is made of a stronger material than stool P.

- (1) A and B only
- (2) A and C only
- (3) B and C only
- (4) A, B and C

21. Jane observed some leaves. She classified the leaves as shown in the table below.

A	B	C	D
			

The diagram below shows leaf X.



Leaf X

In which group should Jane classify leaf X?

- (1) A
- (2) B
- (3) C
- (4) D

22. Which of the following classifications about fungi and ferns are correct?

	Fungi	Fern
A	It is a not a plant.	It is a plant.
B	It reproduces through spores.	It reproduces through spores.
C	It makes its own food.	It feeds on decaying matter.

- (1) A and B only
- (2) A and C only
- (3) B and C only
- (4) A,B and C

23. Old car tyres, made of rubber, are used in outdoor playgrounds for children to play hide-and-seek. Children are able to climb into the stacks of car tyres easily and safely.

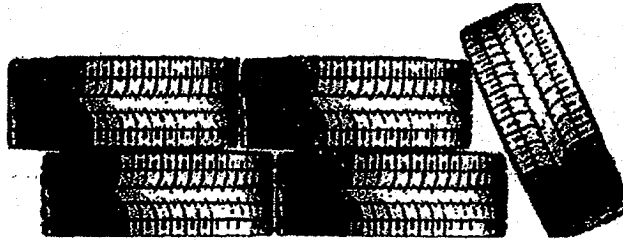

Which of the following properties make a car tyre suitable for the hide-and-seek game at an outdoor playground?

- A: It is strong.
 B: It does not absorb water.
 C: It does not allow light to pass through.

- (1) A and B only
 (2) A and C only
 (3) B and C only
 (4) A, B and C

24. Study the two groups of organisms, A and B, below.

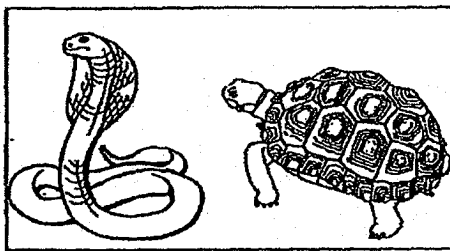

A

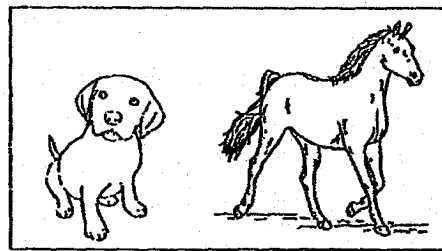

B

Which of the following correctly describes how the organisms are grouped?

	Group	Covered with scales	Give birth to young alive
(1)	A	No	Yes
(2)	A	Yes	Yes
(3)	B	No	Yes
(4)	B	Yes	Yes

25. Five bar magnets with their poles marked A to J are arranged as shown below.

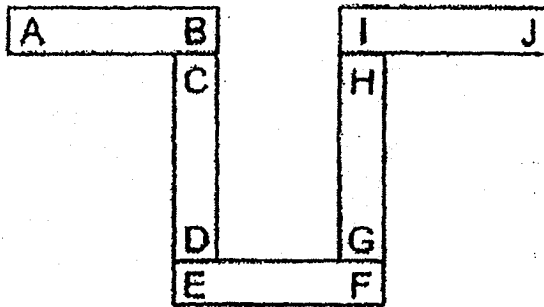

Which one of the following shows a possible arrangement of two magnets?

(1)

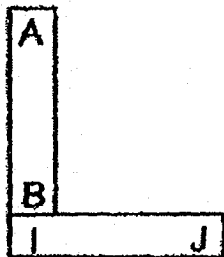

(2)

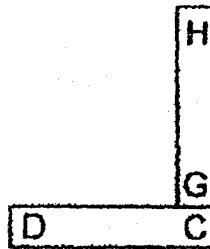

(3)

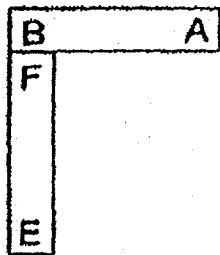

(4)

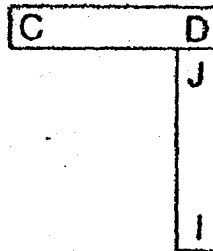

26. Peter wants to find out how the number of batteries affects the strength of an electromagnet. The diagrams below show the arrangements of each set-up.

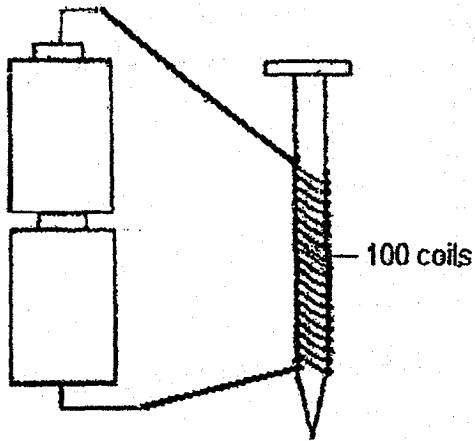

Set-up W

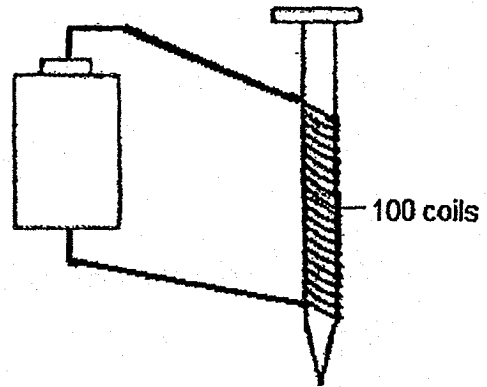

Set-up X

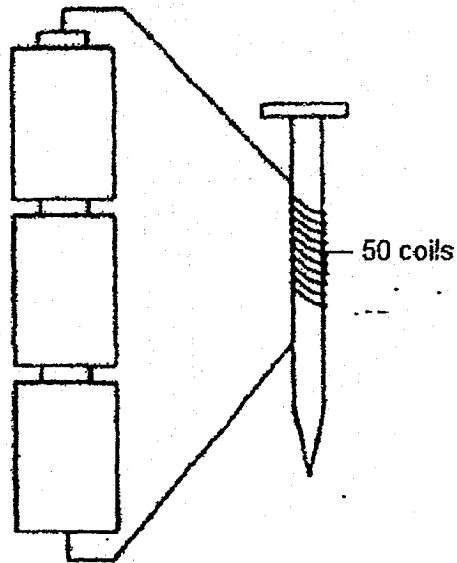

Set-up Y

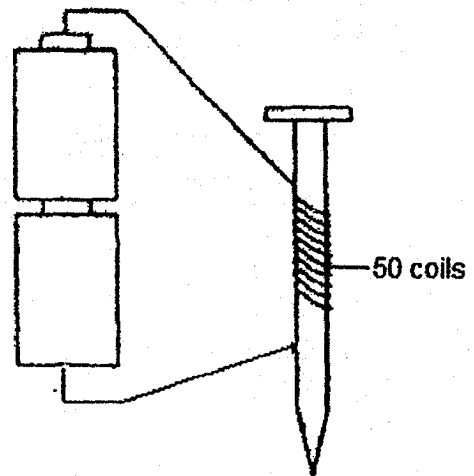

Set-up Z

In order to conduct a fair test, which two set-ups should Peter choose?

- (1) W and Z
- (2) X and Z
- (3) Y and Z
- (4) W and Y

27 A compass has a small magnet that can rotate freely as shown.

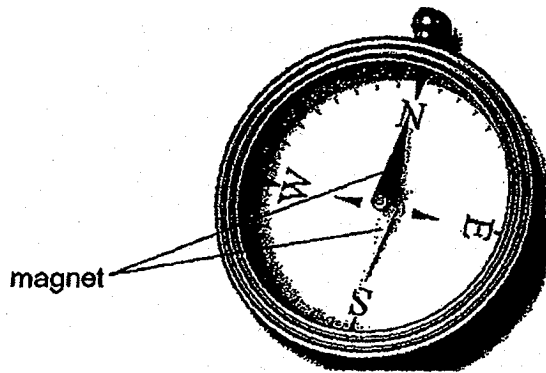

Three bar magnets were arranged such that they were attracted to one another. A compass was then placed near pole H and the direction of the compass needle is as shown below.

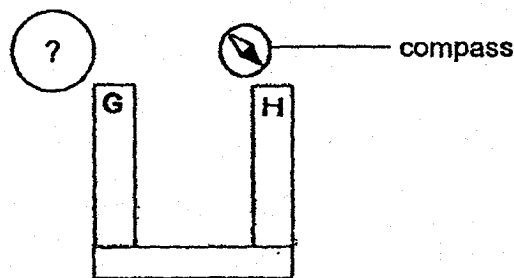

What would be the direction of the needle when the compass (?) was placed near G?

(1)



(2)

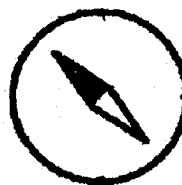

(3)



(4)



28 Look at the classification table below.

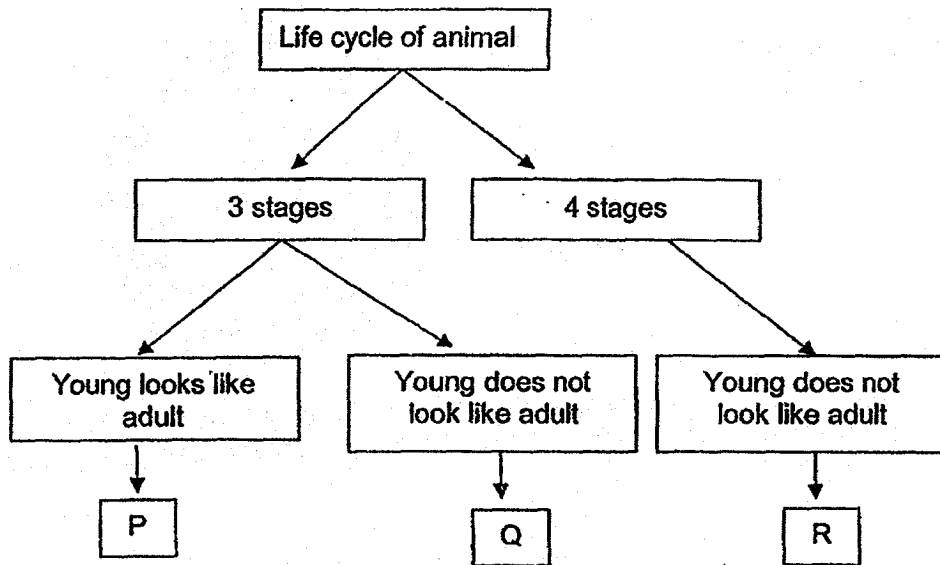

What could organism P, Q and R most likely be?

	P	Q	R
(1)	butterfly	frog	grasshopper
(2)	grasshopper	frog	butterfly
(3)	butterfly	grasshopper	frog
(4)	grasshopper	butterfly	frog

End of Section A



HENRY PARK PRIMARY SCHOOL
FIRST SEMESTRAL ASSESSMENT 2018
PRIMARY 4
SCIENCE
BOOKLET B (44 MARKS)

INSTRUCTIONS TO CANDIDATES

1. Do not turn over this page until you are told to do so.
2. Follow all instructions carefully.
3. Answer all questions.

Name: _____ ()

Class: Primary 4 ()

Date: 14 May 2018

Total Time for Booklets A & B: 1 h 45 min

Marks for Booklet B: _____

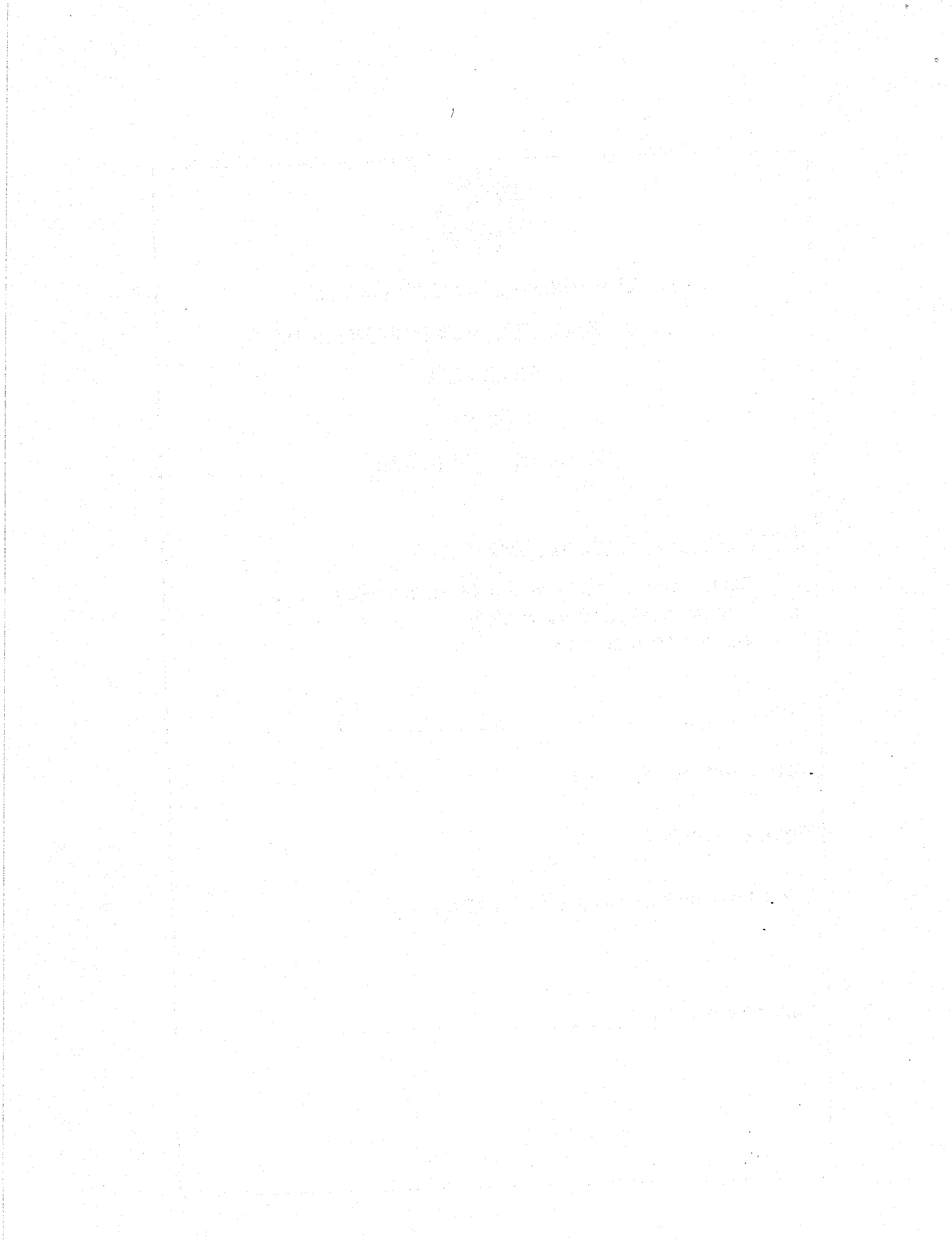

Section B (44 marks)

For questions 29 to 40, write your answers in the space provided.

The number of marks available is shown in brackets [] at the end of each question or part question.

29. Ai Tong puts plant X, with green leaves into a conical flask of red-coloured water.

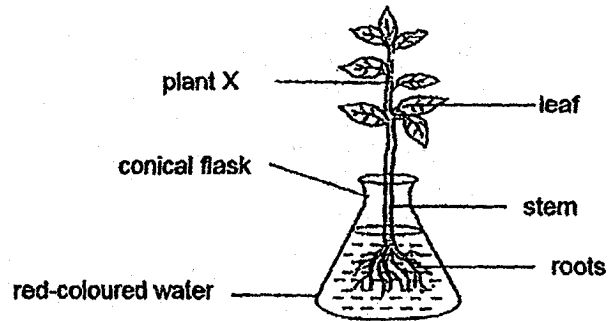

- (a) Name the **main** function of the roots. [1]

- (b) What would Ai Tong observe on the leaves of plant X after six hours? [1]

- (c) Explain the observation made in (b). [2]



30. The diagram below shows an organ system in the human body.

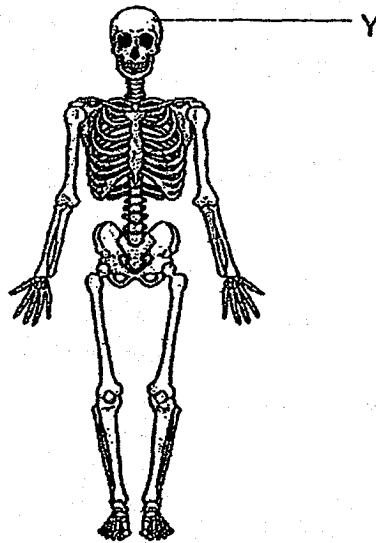

(a) Name the organ system shown above. [1]

(b) State two functions of the organ system shown above. [2]

(i) _____

(ii) _____

(c) Name part Y. [1]



31. Ali set up an experiment as shown below.

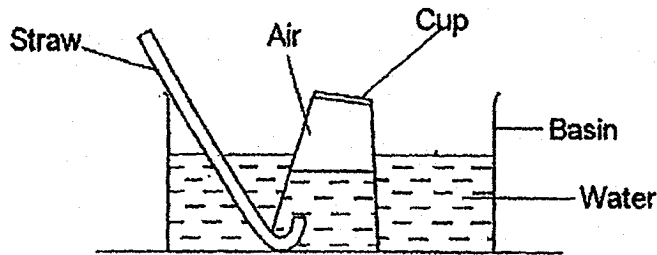

- (a) Ali used a straw to blow air into the cup as shown in the diagram above. He observed that the water level in the cup decreased.

Explain Ali's observation.

[2]

Ali used the same apparatus to do a second experiment. He removed the straw and made a hole on top of the plastic cup as shown in the diagram below.

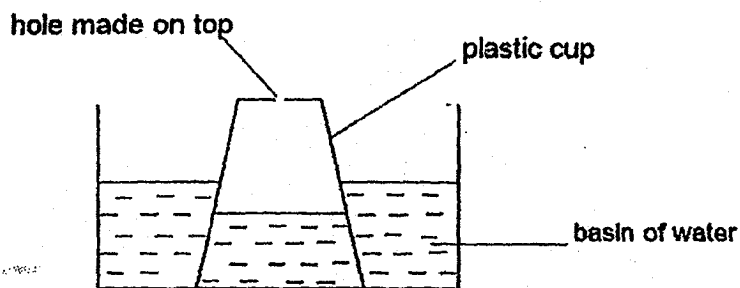

- (b) What would happen to the water level in the cup after the hole was made? Explain why.

[2]



32. Classify **air**, **sound**, **coin** and **sunlight** correctly in the table below.

(a)

[2]

Matter	Non-matter
(i)	(iii)
(ii)	(iv)

(b) Darren wanted to transfer 50 ml of liquid from the beaker onto a petri dish using a plastic dropper. He did the following as shown in the diagram below.

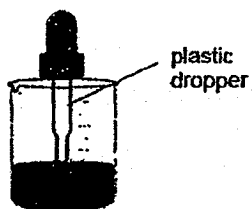

Step 1: Hold the plastic dropper in a vertical position in a beaker of water



Step 2: Insert the dropper inside the water. Squeeze the rubber end of the dropper and bubbles will appear.

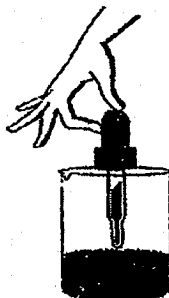

Step 3: Release the rubber end of the dropper and water will enter the dropper.

Explain why bubbles were observed in step 2.

[2]



33. Tom conducted some tests on four materials, P, Q, R and S. He recorded his results in the table shown below.

Property	Materials			
	P	Q	R	S
flexible	X	✓	X	✓
sinks in water	✓	✓	X	✓
waterproof	✓	X	✓	✓
allows most light to pass through	✓	X	X	✓

A tick (✓) indicates the presence of the property while a cross (X) indicates the absence of the property.

- a) Which material should be used to make a float for beginning swimmers? Explain your answer. [2]

- b) Tom concluded that both materials Q and R do not allow any light to pass through. [2] Is Tom correct? Explain why.



34. Fiona measured the mass and volume of a measuring cylinder of water as shown in diagram 1.

She then placed five marbles in the measuring cylinder of the water as shown in diagram 2.

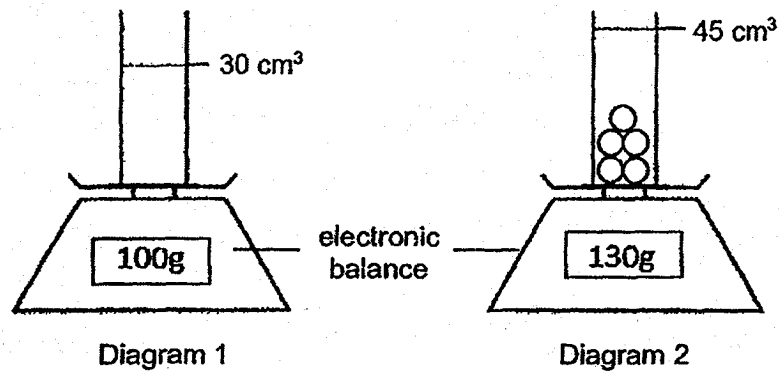

- (a) Based on the information given, state the mass and volume of the marbles. [1]

(i) Mass of the marbles - _____

(ii) Volume of the marbles - _____

- (b) State what happened to the water level when the marbles were placed inside the measuring cylinder. [1]

Fiona filled up her bathtub with water to the brim to take a bath as shown below.

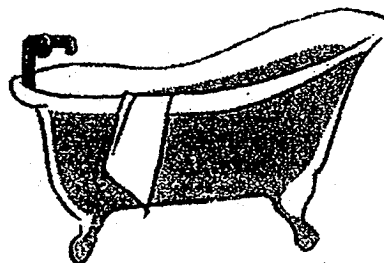

- (c) Explain why the water in the bathtub overflowed when Fiona sat in the bathtub. [2]



35. Nick set up an experiment as shown below.

He fixed a nail with some wax on one end of each of the three rods which are made of different materials. The other ends of the rods were inserted into the container of hot water. The same amount of wax was used for all the three rods.

The three rods have the same thickness and length.

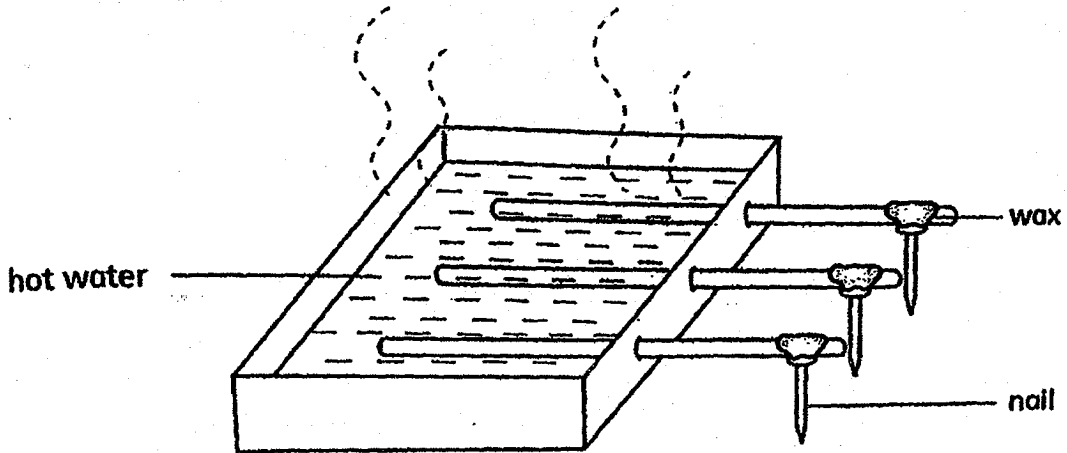

He recorded the time taken for the nail to drop in the table below.

Rod	Time taken for the nail to drop (min)
W	4
X	1
Y	8

(a) Based on the information given, which rod is the poorest conductor of heat? Explain your answer. [2]

(b) Based on your answer in part (a), state a material that the rod is most likely made of. [1]

(c) Explain why the nails from rods X, Y and W will fall off after some time. [1]



36. Mona places a metal spoon at room temperature in a cup of hot coffee. The temperature of the coffee is $90\text{ }^{\circ}\text{C}$.

After a few minutes, the metal spoon became very hot.

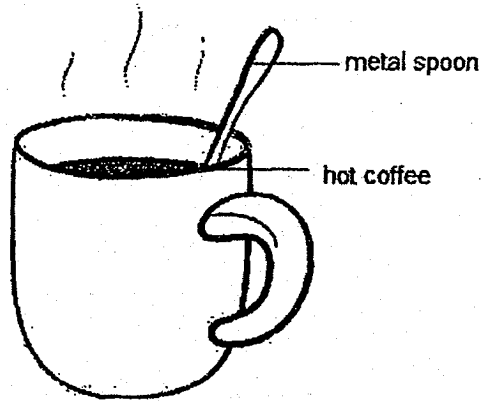

- (a) Explain why the metal spoon became very hot in a short time. [2]

- (b) What happens to temperature of the hot coffee after some time? Explain your answer. [2]



37. The diagram below shows organism Q growing in a garden.

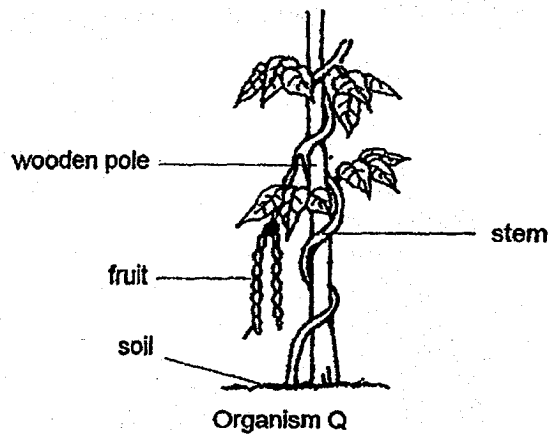

Ben and Carol observed organism Q and made the following statements.

Ben: "This is not a flowering plant because it has no flowers."
Carol: "This is a flowering plant. It produces fruits."

(a) Whose statement is not correct? Explain why.

[2]



Question 37 continued

Ravi observed that organism R appeared the next day after it rained near organism Q.

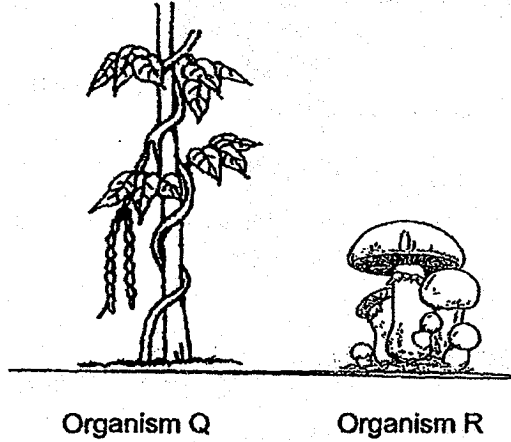

- (b) Based on the information given, state one condition necessary for organism R to grow. [1]



38. The diagram below shows a bicycle.

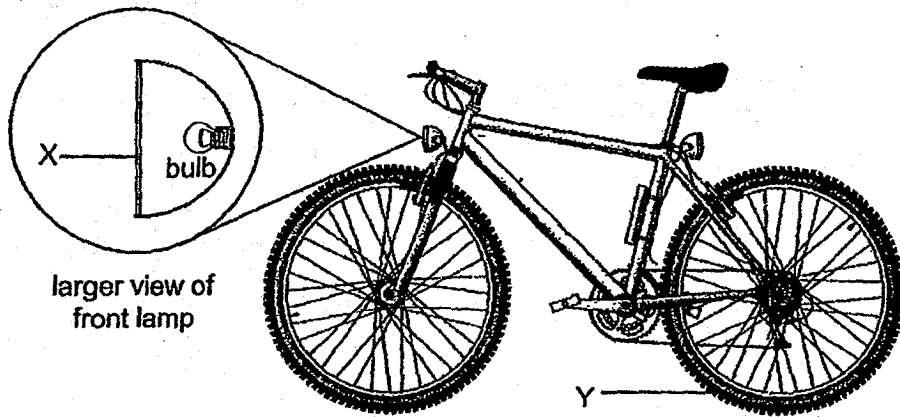

The bulb in the front lamp gives out light.

In the table below, state the useful properties of the materials parts X and Y are made of. [2]

Part of the bicycle	State two useful properties of the material used to make each part
X	i) _____ ii) _____
Y	i) _____ ii) _____



39. Mark has two bars labelled M and N and a rod magnet.
Bar N was attracted to the rod magnet as shown in the diagram below.

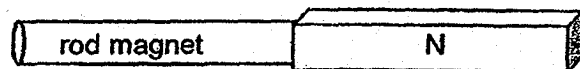

- (a) Can this observation be used to conclude that bar N is a magnet? Explain why. [1]

Then he carried out an experiment using the two bars and the rod magnet. From his experiment, he concluded that bar M is a magnet.

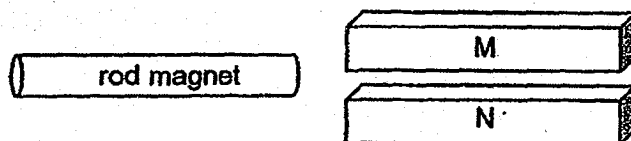

- (b) Explain what he did and the observation he made to come to the conclusion that bar M is a magnet. [2]



40 Study the following classification chart of some animals.

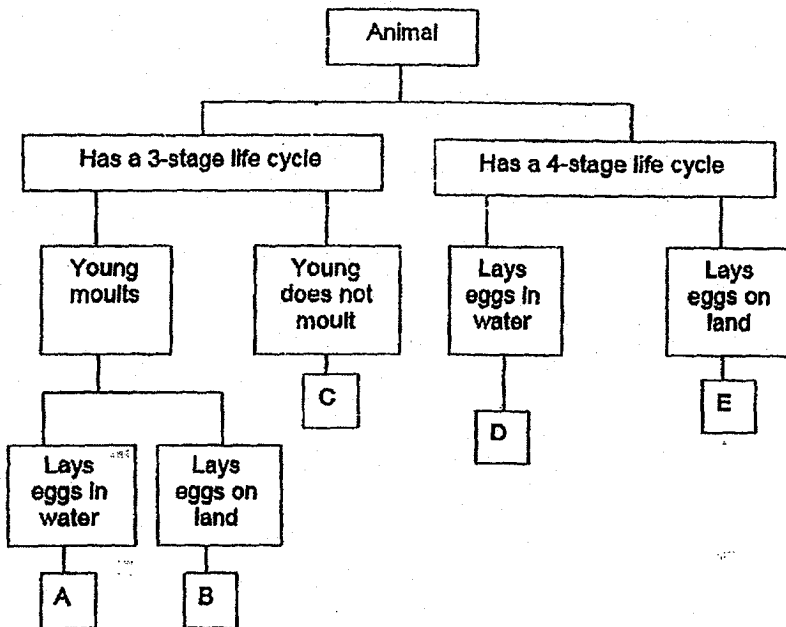

Based on the information given, answer the questions below.

(a) State one similarity between animals A and D. [1]

(b) State one difference between animals B and C. [1]

(c) Put a (✓) in the correct box for an animal that represents animal B and another animal that represents animal E. [2]

	Animal B	Animal E
(i) chicken		
(ii) cockroach		
(iii) mosquito		
(iv) beetle		

End of Section B



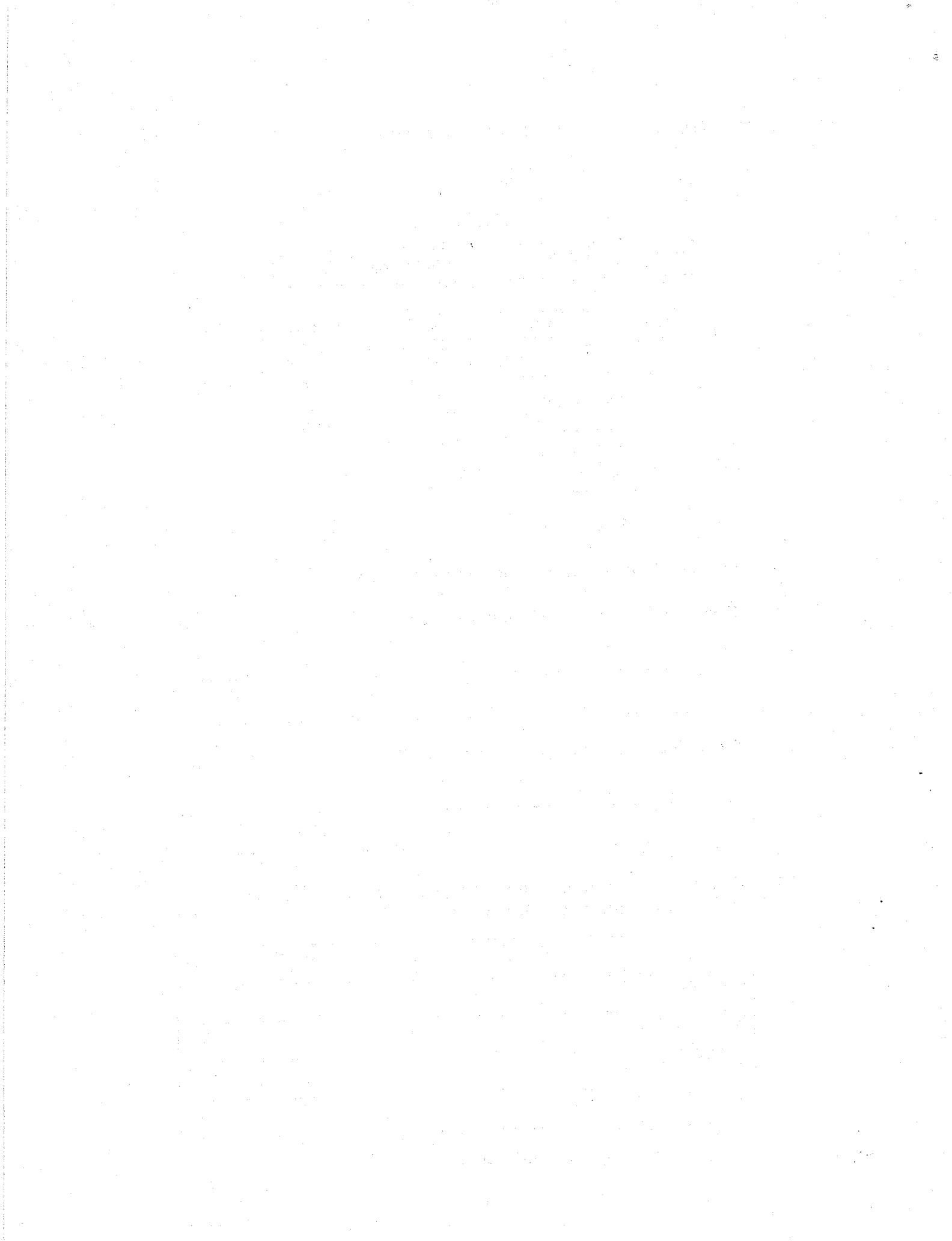

EXAM PAPER 2018 (P4)

SCHOOL : HENRY PARK

SUBJECT : SCIENCE

TERM : SA1

Q1	Q2	Q3	Q4	Q5	Q6	Q7	Q8	Q9	Q10
2	3	3	1	2	1	1	4	2	3
Q11	Q12	Q13	Q14	Q15	Q16	Q17	Q18	Q19	Q20
2	3	2	4	3	3	3	2	1	3
Q21	Q22	Q23	Q24	Q25	Q26	Q27	Q28		
1	1	4	3	1	3	2	2		

Q29) a) The roots absorb water from the ground.

b) The leaf would turn red.

c) The stem has a small tube in it. It transports the red water from the roots and to the leaves of the plant, therefore making it red.

Q30) a) Skeletal system

b) (i) It gives our body shape.

(ii) It protects vital organs

c) Skull

Q31) a) Air has a definite volume and takes up space. As air enters the cup, water is pushed out and the water level decreases.

b) Water level will increase. The hole is cut and air will escape the plastic cup, leaving space for water to come up and increase in water level.

Q32) a) (i) air

(ii) coin

(iii) sound

(iv) sunlight

b) There was air trapped in the dropper. When the dropper was squeezed, the air escape was pushed out into the water.

Q33) a) A float must be waterproof and cannot sink in water, material Q is the only material that has this property.

b) No. Because both Q and R may allow some light to pass through.

Q34) a) (i) 30g

(ii) 15 cm³

b) The marbles have definite volume and occupies space in the measuring cylinder and the water level will increase.

c) Fiona took up space in the bathtub and displaced the water occupying space in the bathtub.

Q35) a) Y. Rod Y took the longest time to heat up and make the wax melt.

b) Plastic

c) As the rods slowly gain heat, the wax will melt and the nails will fall off.

Q36) a) The metal spoon gained heat quickly from the hot coffee.

b) Temperature of coffee decreases to room temperature as it loses heat to the metal spoon.

Q37) a) Ben. A flowering plant produces fruits but Ben said that Organisms Q is not a flowering plant. Q produces fruits.

b) Organisms R needs moisture to grow.

Q38) X : i) Allows most light to pass through

ii) Does not break easily.

Y : i) Flexible

ii) Waterproof

Q39) a) No. Bar N might be magnetic material but not a magnet.

b) He bought both ends of Bar M to a pole of the rod magnet. One of the ends repelled the pole of the magnet.

Q40) a) They both lay eggs in water.

b) Animal B has young that moult but C does not

c) Animal B : cockroach

Animal E : beetle

