



ST. HILDA'S PRIMARY SCHOOL
END-OF-YEAR EXAMINATION, 2024

PRIMARY 4

SCIENCE

Booklet A

Name : _____ ()

Class: Primary 4 / _____

Date: 22 October 2024

Total Time for Booklets A and B: 1 hour 45 minutes

Additional Materials: Optical Answer Sheet (OAS)

INSTRUCTIONS TO CANDIDATES

1. Write your name, index number and class above.
2. Do not turn over this page until you are told to do so.
3. Follow all instructions carefully.
4. Answer all questions.
5. Use a 2B pencil to shade your answers on the Optical Answer Sheet (OAS).

This booklet consists of 19 printed pages.

For each question from 1 to 28, four options are given. One of them is the correct answer. Make your choice (1, 2, 3 or 4) and shade your answer on the Optical Answer Sheet.

(56 marks)

- 1 Sherry found a plant in the garden and measured its height. After two weeks, she measured its height again.

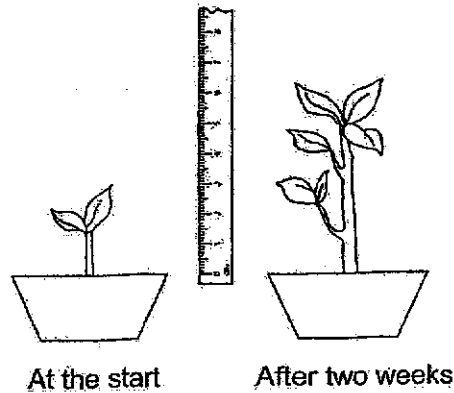

From her observation, Sherry concluded that the plant is a living thing because it can

- (1) grow
 (2) breathe
 (3) reproduce
 (4) respond to changes
- 2 Four students made the following statements about fungi.

	Statement
Ali	Fungi reproduce from spores.
Betty	Fungi can make their own food.
Carl	Fungi can be harmful or useful to man.
Dawn	Fungi can be seen only under a microscope.

Who have made the correct statements?

- (1) Ali and Betty only
 (2) Ali and Carl only
 (3) Betty and Dawn only
 (4) Carl and Dawn only

3 Study the flow chart.

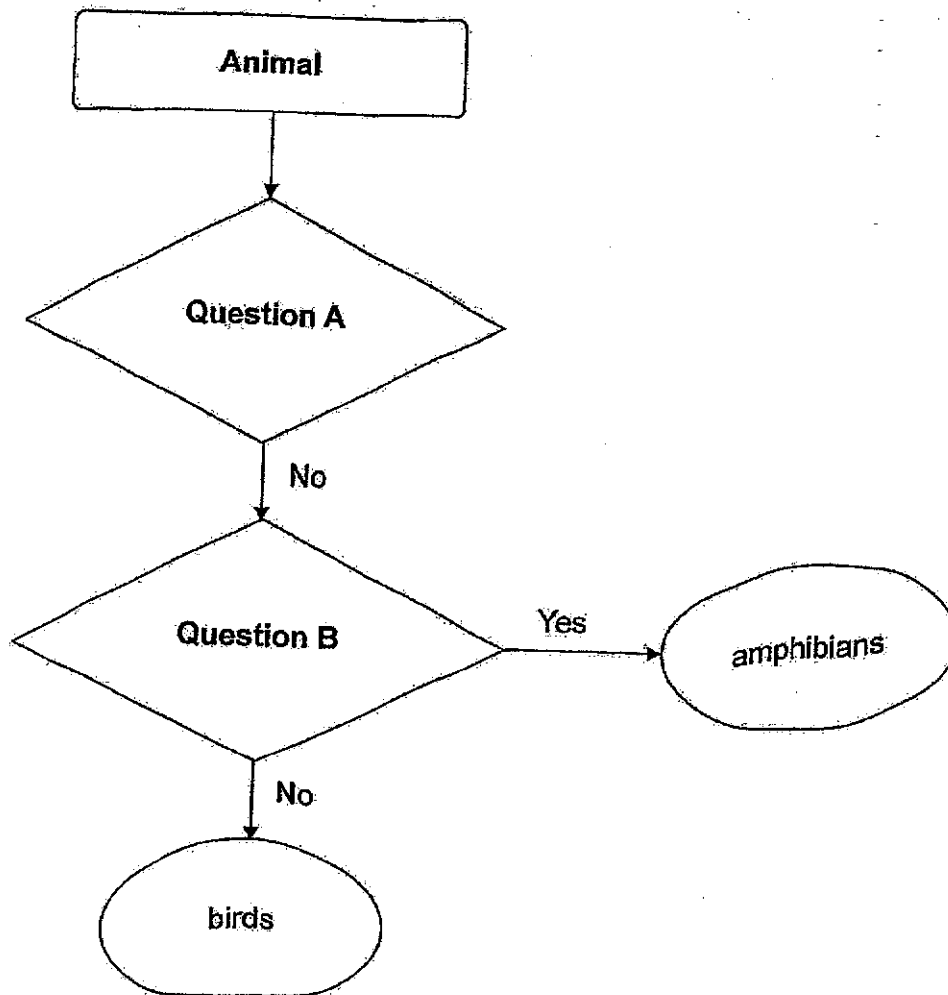

Which of the following shows the correct questions for A and B?

	Question A	Question B
(1)	Gives birth to its young?	Has scales as outer covering?
(2)	Gives birth to its young?	Has moist skin as outer covering?
(3)	Lays eggs?	Has scales as outer covering?
(4)	Lays eggs?	Has fur as outer covering?

- 4 Which human system is shown in the diagram?

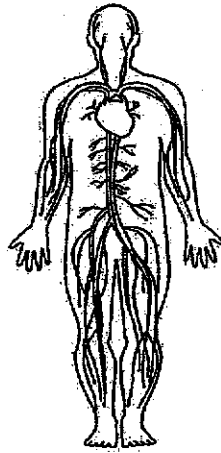

- (1) skeletal system
 (2) muscular system
 (3) circulatory system
 (4) respiratory system
- 5 Study the diagram below.

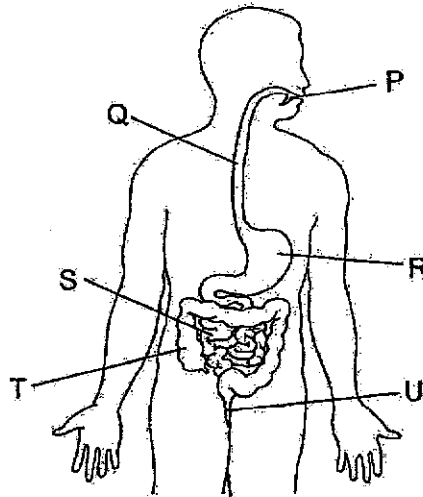

Which of the following shows how food travels through the digestive system before the digested food enters the blood?

- (1) $R \rightarrow S \rightarrow T \rightarrow U$
 (2) $R \rightarrow T \rightarrow S \rightarrow U$
 (3) $P \rightarrow Q \rightarrow R \rightarrow T$
 (4) $P \rightarrow Q \rightarrow R \rightarrow S$

6 Which of the following statements about the human digestive system are correct?

- A Digested food is absorbed in the stomach.
- B Digestive juice is present in the small intestine.
- C No digestion takes place in the large intestine.
- D Water is absorbed from the digested food in the large intestine.

- (1) A and B only
- (2) B and C only
- (3) A, C and D only
- (4) B, C and D only

7 The diagram below shows the life cycle of an animal.

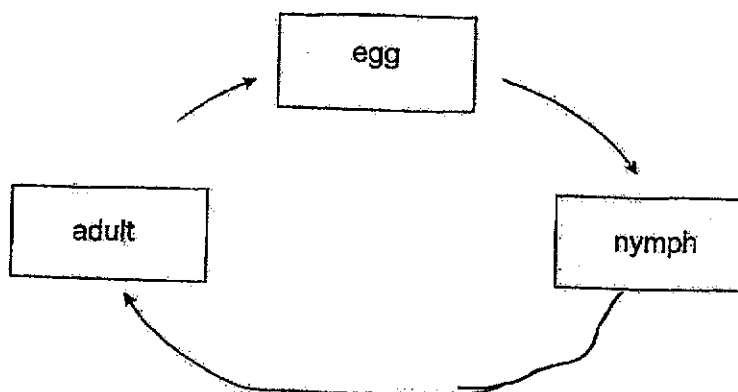

Which animal is likely to have the life cycle as shown above?

- (1) chicken
- (2) butterfly
- (3) beetle
- (4) cockroach

- 8 Study the life cycles of plant A and animal B.

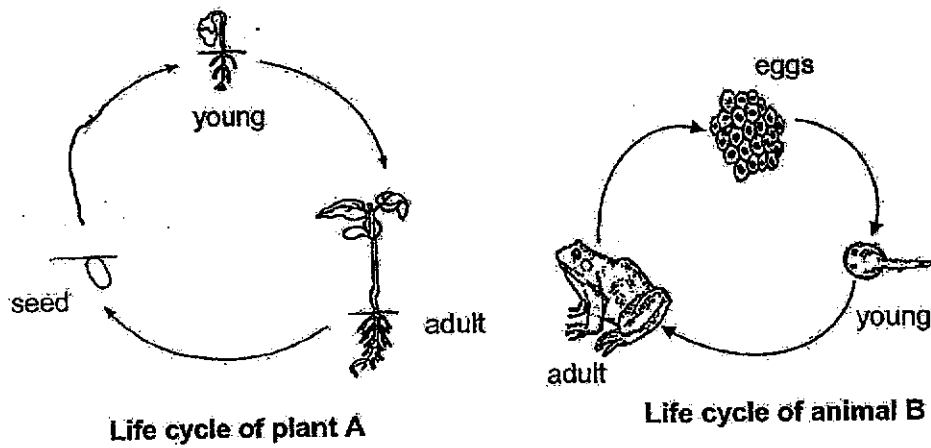

Which statement correctly describes the life cycles?

- (1) Animal B have all its stages in water.
 - (2) The young of both plant A and animal B look like the adults.
 - (3) Plant A and animal B have different number of stages in their life cycles.
 - (4) Plant A and animal B have the same number of stages in their life cycles.
- 9 The diagram below shows a flowering plant at different stages.

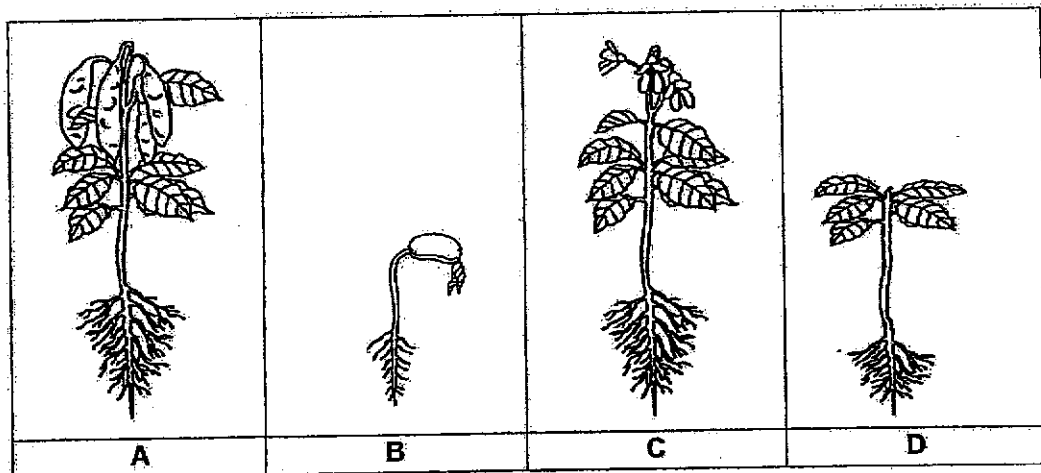

Which of the diagrams above most likely show the plant in the adult stage?

- (1) B and D only
- (2) B, C and D only
- (3) A and C only
- (4) A, C and D only

- 10 Which part, (1), (2), (3) or (4), makes food for the plant?

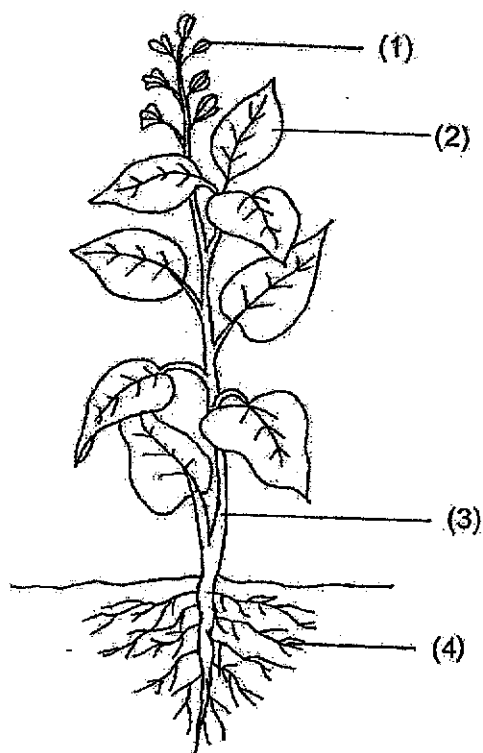

- 11 A tree fell to the ground during a thunderstorm as shown in the diagram.

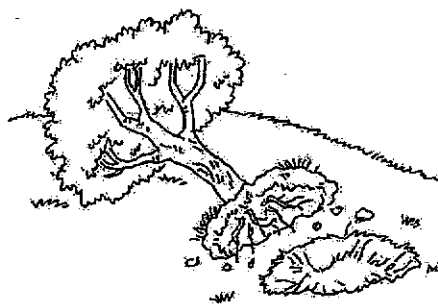

A week later, the tree was dying as it could not _____.

- (1) stand upright
- (2) trap enough sunlight
- (3) absorb water from the soil
- (4) support the branches and leaves

- 12 Lee Ming wanted to find out if the number of leaves of a plant would affect the volume of water it absorbed. He chose three similar types of plants, A, B and C but with different number of leaves as shown below. He placed the plants into three identical beakers with the same volume of water and left them in the garden.

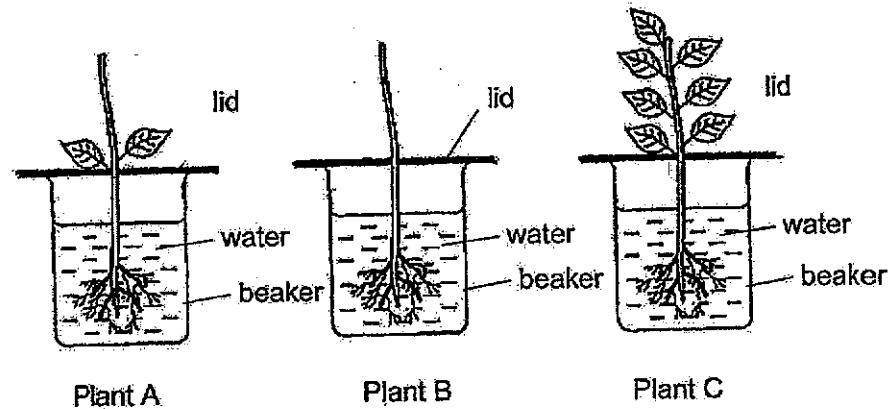

After a week, he measured the volume of water left in each beaker and recorded the results in the table below.

Plant	Volume of water at first (ml)	Volume of water left (ml)
A	600	400
B	600	550
C	600	300

Based on the results in the table, what is the most likely conclusion of the experiment?

- (1) The plant with no leaves did not absorb any water.
- (2) The number of leaves does not affect the volume of water absorbed by the plant.
- (3) The plant with the greatest number of leaves absorbed the most volume of water.
- (4) The greater the number of leaves, the greater the volume of water left in the beaker.

- 13 The diagram shows a hammer.

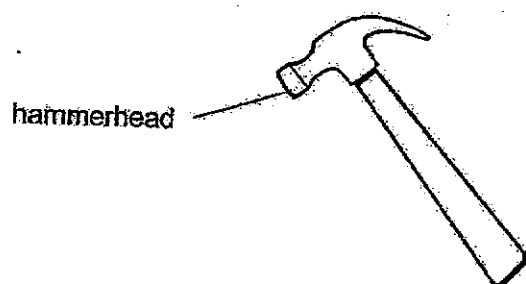

Metal is used to make the hammerhead of the hammer because metal _____.

- (1) is shiny
- (2) does not break easily
- (3) can bend without breaking
- (4) is a good conductor of heat

- 14 Study the diagram below.

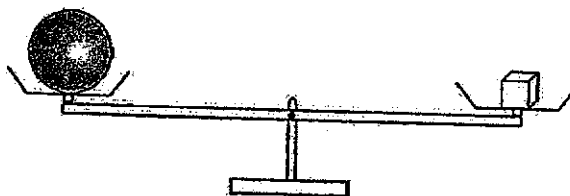

Both objects have the same _____.

- (1) size
- (2) mass
- (3) shape
- (4) volume

15 In which one of the following will the two magnets push each other away?

(1)

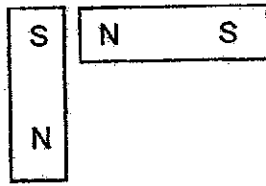

(2)



(3)

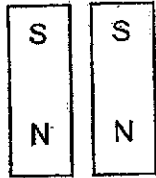

(4)

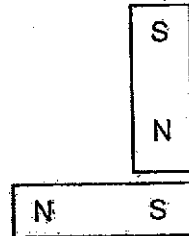

16 Object A was attracted to a magnet, as shown in the figure below.

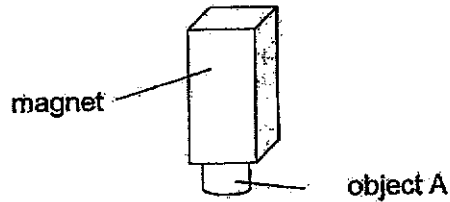

Object A is made of _____.

- (1) rubber
- (2) plastic
- (3) wood
- (4) steel

17 Which of the following is a source of light?

(1)



a leaf

(2)



the moon

(3)



a candle flame

(4)



an apple

18 Ali places a metal spoon in a cup of hot milk.

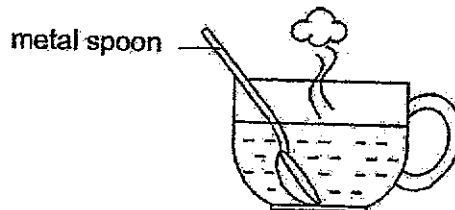

a cup of hot milk

The spoon becomes hotter after a while.

Which one of the following explains this?

- (1) The cup loses heat to the hot milk.
- (2) The spoon gains heat from the hot milk.
- (3) The hot milk gains heat from the spoon.
- (4) The spoon loses heat to the hot milk.

19. A sealed metal container holds 200 cm^3 of water and 100 cm^3 of air as shown in the diagram below.

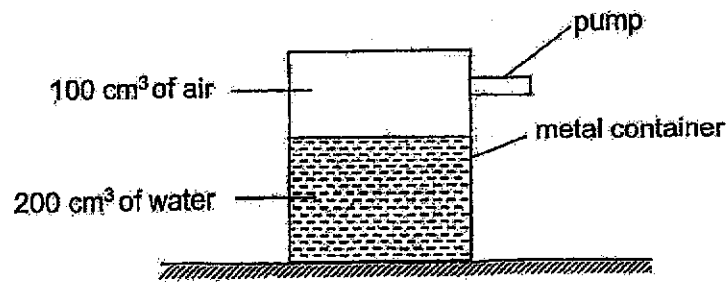

Then, another 50 cm^3 of air was pumped into the metal container. What was the final volume of air in the container?

- (1) 50 cm^3
 (2) 100 cm^3
 (3) 150 cm^3
 (4) 200 cm^3
20. The following experiment was set up to measure the volume of a ball.

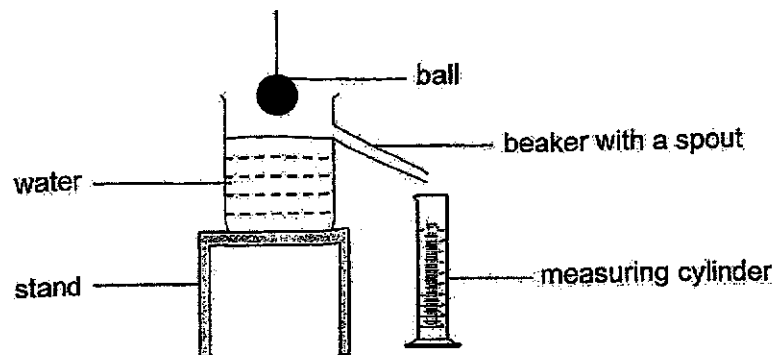

Which of the following statements are correct so that the volume of the ball can be measured accurately?

- A The mass of the ball must be measured first.
 B The ball must be fully immersed in the water.
 C The ball must be placed gently into the water.
 D The water level in the measuring cylinder must be read at eye level.

- (1) A and C only
 (2) A, B and D only
 (3) B, C and D only
 (4) A, B, C and D

21. Firemen wear the clothing as shown when they put out fires.

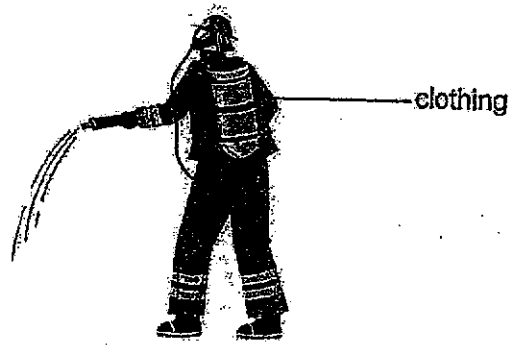

Based on the properties shown below, which material is most suitable for making the firemen's clothing?

	Material	Property		
		Flexible	Waterproof	Good conductor of heat
(1)	A	✓	X	✓
(2)	B	X	✓	X
(3)	C	✓	✓	✓
(4)	D	✓	✓	X

Key:
 ✓ : yes
 X : no

22 Siti conducted an experiment on three types of strings F, G and H by hanging weights from each string. She increased the weights until the string broke. The maximum weight that the strings could hold before breaking is as shown below.

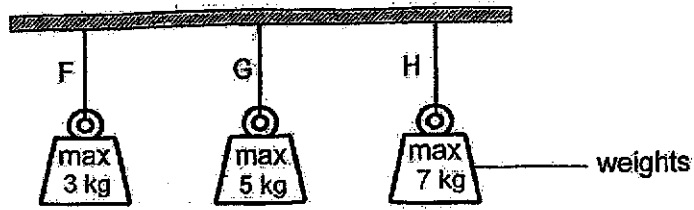

Siti tried hanging different weights in different arrangements.

Which one of the following arrangements would be possible?

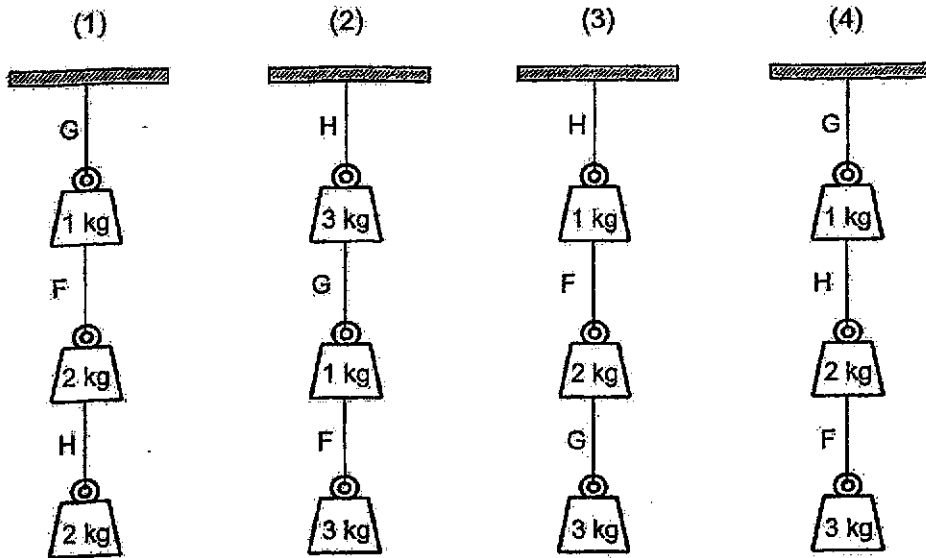

23. Jaymie wanted to find out if the number of batteries will affect the magnetic strength of an iron nail coiled with wires.

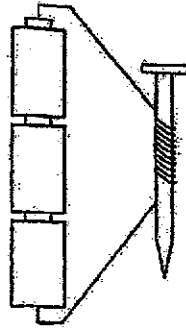

Set-up A
(10 turns of wires around the nail)

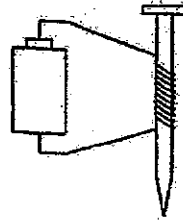

Set-up B
(10 turns of wires around the nail)

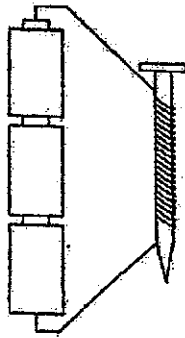

Set-up C
(20 turns of wires around the nail)

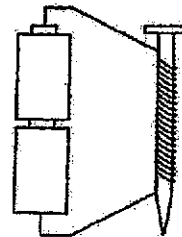

Set-up D
(20 turns of wires around the nail)

Which two setups should she use in order to carry out a fair test?

- (1) A and C
- (2) A and D
- (3) C and D
- (4) B and C

24 Magnets with poles P, Q and R were on a toy train as shown in Diagram 1.

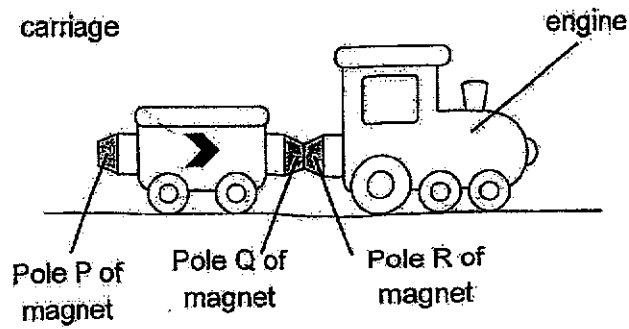

Diagram 1

When Jim turned the carriage around, the engine and carriage were pushed apart as shown in Diagram 2.

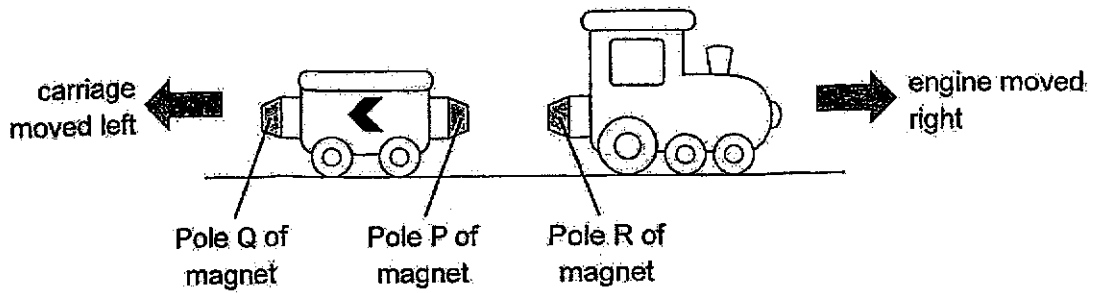
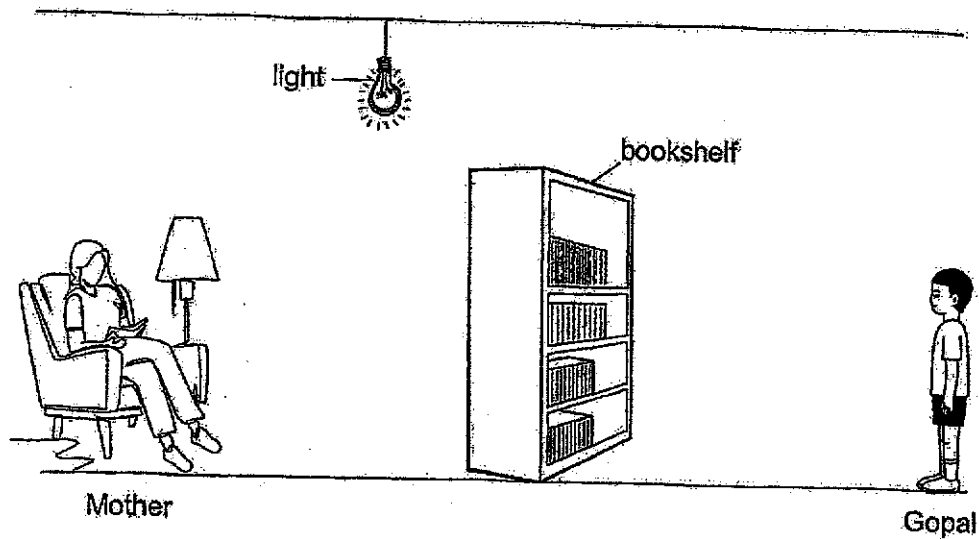

Diagram 2

Which of the following is correct about the poles P, Q and R of the magnets?

Poles of magnets			
	P	Q	R
(1)	S	N	N
(2)	N	S	N
(3)	N	S	S
(4)	S	S	N

- 25 When Gopal was standing in front of the bookshelf as shown below, he could not see his mother.



Which one of the following statements explains why Gopal could not see his mother?

- (1) His mother did not reflect light.
- (2) His mother did not give off light.
- (3) The bookshelf did not give off light.
- (4) The bookshelf did not allow light to pass through.

26 The set-up below shows light shining on three wooden objects A, B and C of different shapes but of the same height. They are placed at different distances from the torch.

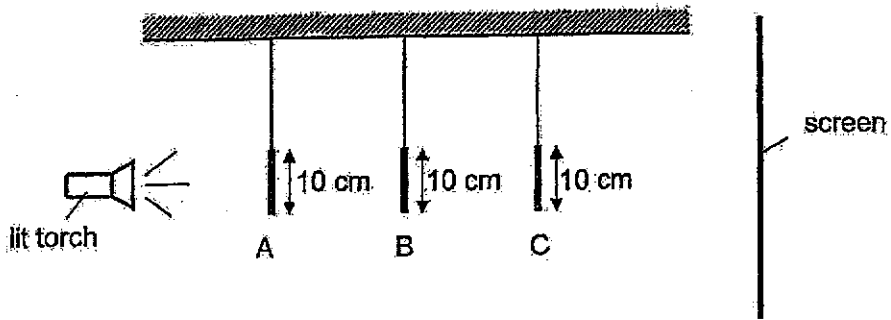

The diagram below shows the shadow of the objects on the screen.

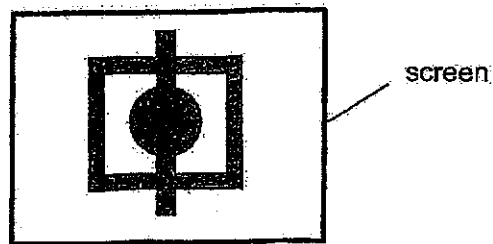

What are the shapes of objects A, B and C?

	A	B	C
(1)			
(2)			
(3)			
(4)			

- 27 The ring and the ball shown below were made of the same material.

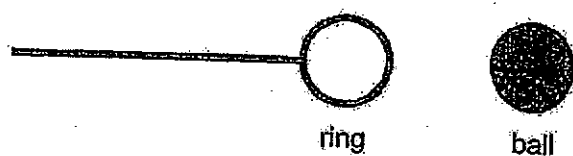

At room temperature, the ball was unable to pass through the ring. After heating the ring for a while, the ball was able to pass through the ring.

Which of the following explains what had happened to the ring and the ball?

	The ring	The ball
(1)	expanded	contracted
(2)	expanded	remained the same size
(3)	remained the same size	contracted
(4)	remained the same size	remained the same size

- 28 Davish had two cups, X and Y, made of material Q. He poured an equal volume of hot tea into each cup. Cup X was too hot to hold but he can hold cup Y easily as shown.

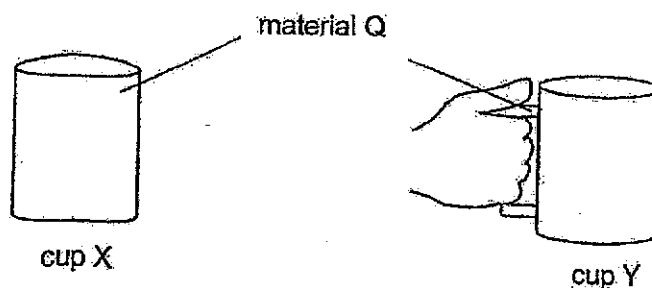

Which of the following best explains why Davish could hold cup Y easily but not cup X?

- (1) Cup X is a better conductor of heat than cup Y.
- (2) Cup Y is a poorer conductor of heat than cup X.
- (3) His hand is further from the heat source in cup Y.
- (4) Cup X is a good conductor of heat but the handle of cup Y is a poor conductor of heat.

End of Booklet A



**ST. HILDA'S PRIMARY SCHOOL
END-OF-YEAR EXAMINATION, 2024**

PRIMARY 4

SCIENCE

Booklet B

Name : _____ ()

Class: Primary 4 / _____

Date: 22 October 2024

Total Time for Booklets A and B: 1 hour 45 minutes

Parent's Signature:

INSTRUCTIONS TO CANDIDATES

1. Write your name, index number and class above.
2. Do not turn over this page until you are told to do so.
3. Follow all instructions carefully.
4. Answer all questions.
5. Use a pencil or dark blue or black ballpoint pen to write your answers in the space provided for each question.
6. Do not use correction fluid/tape or highlighters on any part of your answers.

Booklet	Maximum Marks	Marks Obtained
A	56	
B	44	
Total	100	

This booklet consists of 15 printed pages.

For questions 29 to 40, write your answers in this booklet.
 The number of marks available is shown in brackets [] at the end of each question or part question.

(44 marks)

29 The diagram below shows a fish tank.

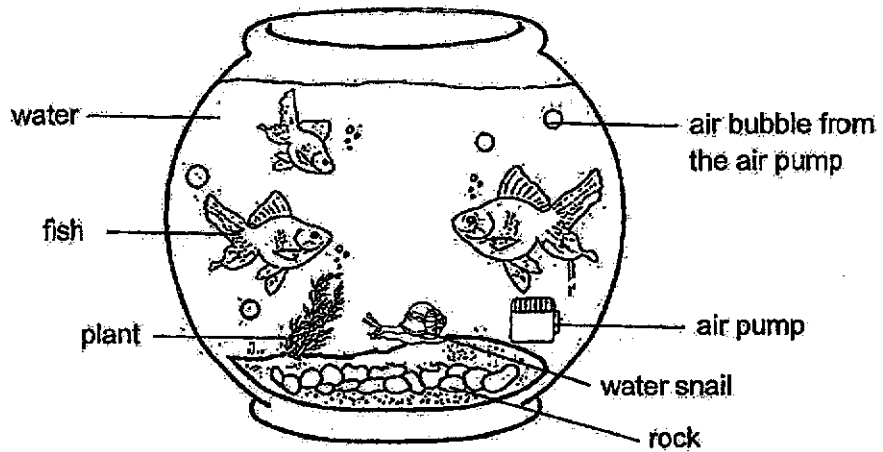

(a) Identify two living things labelled in the diagram above. [1]

(i) _____ (ii) _____

(b) Identify two non-living things labelled in the diagram above. [1]

(i) _____ (ii) _____

(c) When the air pump was not switched on for a while, the fish were often seen [1]
 swimming near the surface of the water. Give a reason for this observation.

(continues on next page)

SCORE	3
-------	---

(d) There was no new fish added into the fish tank but the number of fish in the tank increased after a few weeks. Explain why. [1]

(e) The snail hid in its shell when the fish went near it. What characteristic of living things does this show? [1]

SCORE	
-------	---

30 The diagram below shows the human digestive system.

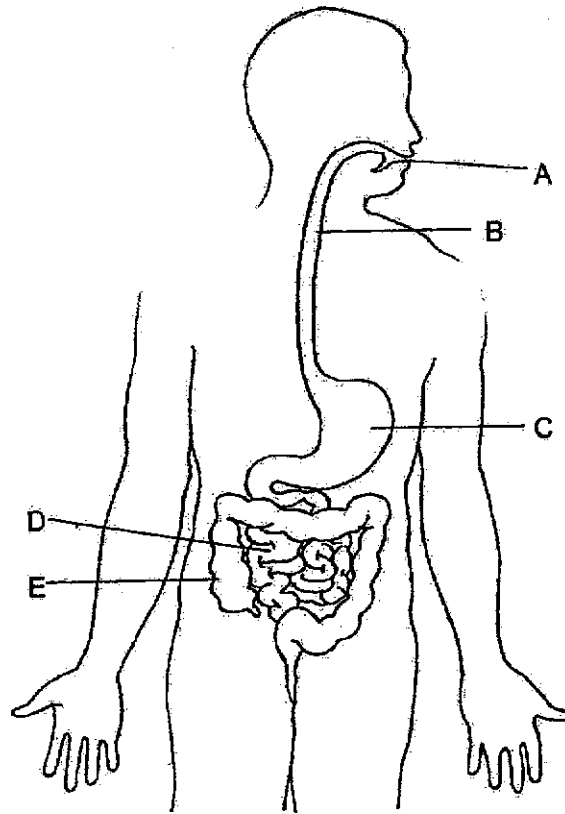

Identify the part where

- (a) digestion first takes place: _____ [1]
- (b) digestion is completed: _____ [1]
- (c) no digestive juice is produced: _____, _____ [2]

SCORE	4
-------	---

31 John ate a heavy meal. The graph below shows the amount of undigested food leaving each organ P, Q, R, S and the large intestine after the heavy meal.

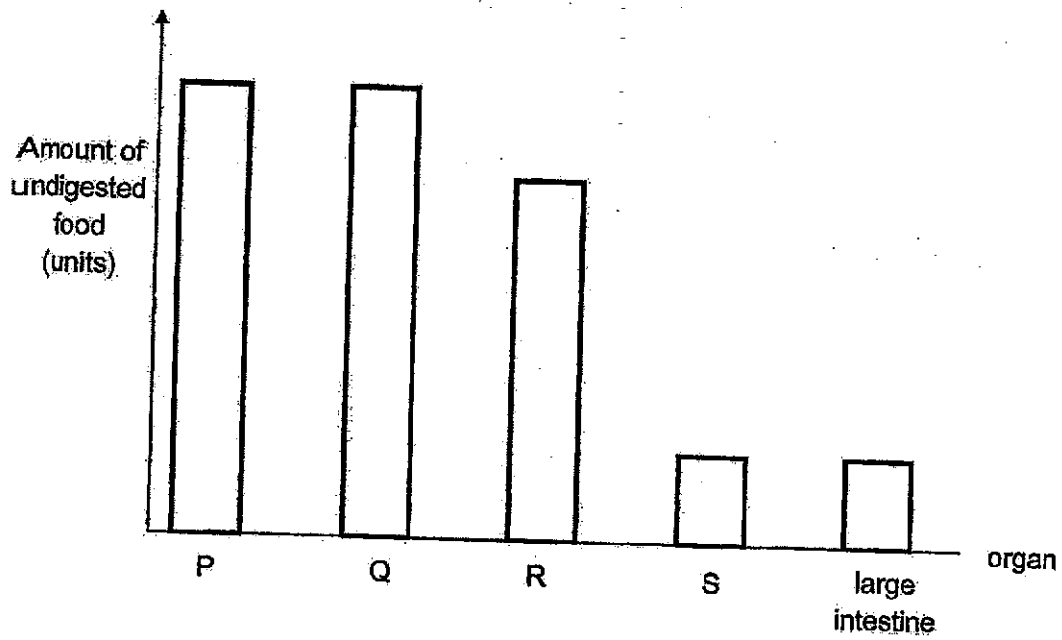

(a) Which organ, P, Q, R or S represents the small intestine? Give a reason for your answer. [2]

(b) John was told that chewing his food before swallowing helps in digestion. Explain how chewing the food helps in digestion. [2]

SCORE	4
-------	---

32(a) Classify the following animals according to the number of stages in their life cycle. [2]



chicken



butterfly



beetle



grasshopper

Three Stages	Four Stages

(continues on next page)

SCORE	2
-------	---

The diagram below shows the life cycle of an Aedes mosquito.

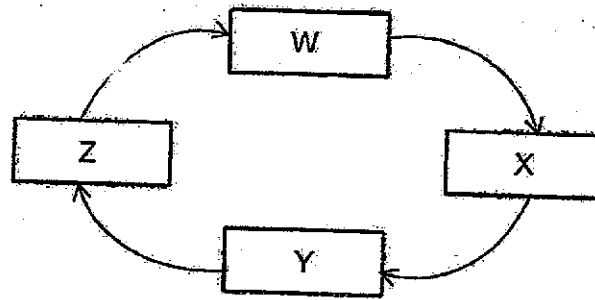

The diagram below shows the Aedes mosquito at stage W. The mosquito is harmful to humans as it will suck the blood and spread the dengue fever virus to humans.



- (b) Based on the information given, name the stages of the life cycle of the mosquito which are represented by each letter in the table below.

[2]

Letter	Name the stages of the life cycle
W	
X	
Y	
Z	

- (c) At which stage of the life cycle of the mosquito will it be the hardest to prevent the spread of dengue fever virus. Explain why.

[1]

SCORE	3
-------	---

- 33 Siti conducted an experiment with four different materials, P, Q, R and S. She placed material P on top of two wooden blocks. Then, she kept adding weights to the centre of material P until it broke. She repeated the experiment with materials Q, R and S, one at a time.

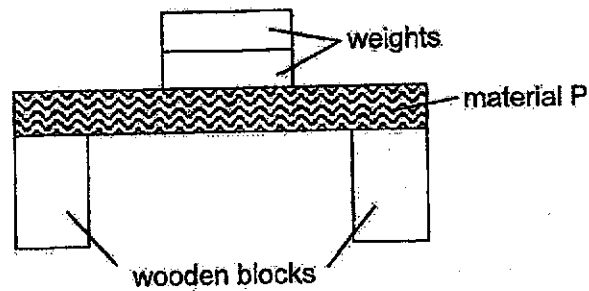

The table below shows the maximum amount of weights each material can hold before breaking.

Material	Maximum amount of weights each material holds (kg)
P	7
Q	4
R	2
S	12

- (a) What physical property of material was Siti testing? [1]
-
- (b) Which material, P, Q, R or S is the weakest? Give a reason for your answer. [1]
-
- (c) Siti's books weigh around 8kg. Which material, P, Q, R or S should she use to make a bag to carry her books? [2]
-

- 34 Kumar wanted to find out if the pins made of different materials can be attracted by the magnet. He brought a magnet near a tray of pins made of different materials.

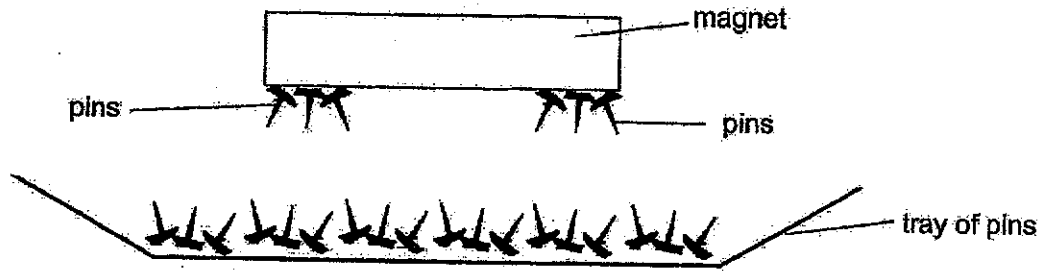

- (a) Which variable(s) should Kumar keep the same or change so that his experiment is a fair one?
Tick (✓) the correct boxes.

[2]

Variables	Kept the same	Changed
shape of magnet		
distance between magnet and pins		
material of pins		
length of magnet		

- (b) Some of the pins were attracted to the magnet as shown above. What material are the pins made of?

[1]

- (c) Explain why the poles of the magnet could attract the most number of pins.

[1]

SCORE	4
-------	---

- 35 The diagram below shows how Jane sees her cat at night.

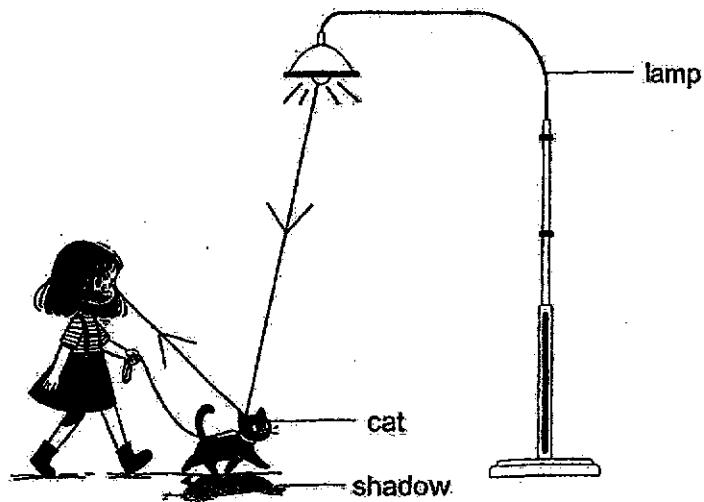

- (a) The _____ from the lamp is _____ by the cat and enters Jane's eye. [2]
- (b) Jane observed that a shadow of her cat had formed on the ground.
State how a shadow is formed. [1]

SCORE	3
-------	---

- 36 Bella wanted to install some blackout curtains for her room. Blackout curtains are designed to block out light completely. She was given four types of materials W, X, Y and Z to choose from to make her curtains. She used a datalogger with a light sensor to record the amount of light that passed through each material.

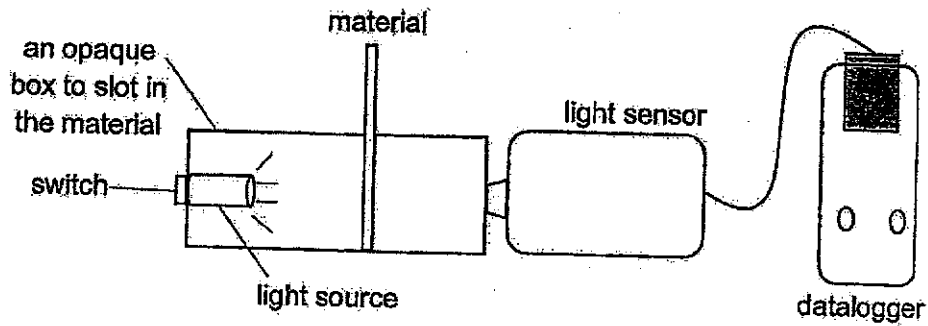

The graph below shows the result of her testing.

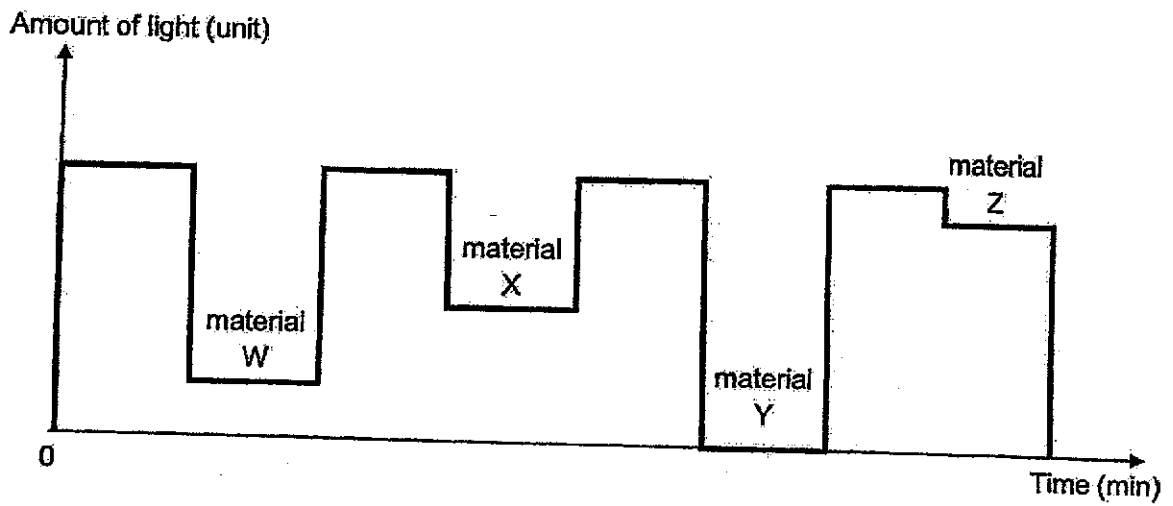

- (a) Fill in the boxes to arrange the materials, W, X, Y and Z in order of transparency. [1]

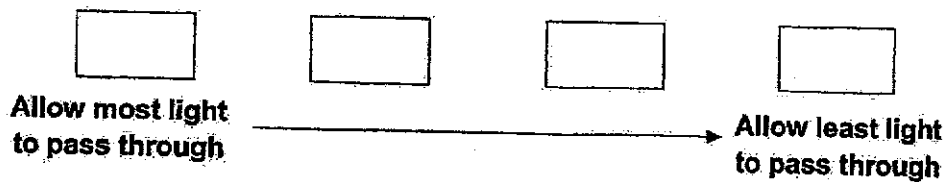

- (b) Which material, W, X, Y or Z should she choose to make her blackout curtains? Explain your answer. [2]

SCORE	3
-------	---

- 37 The diagram below shows a jug of orange juice.



- (a) Circle the correct state for the following things:

(i) orange juice: (solid / liquid / gas) [1]

(ii) jug : (solid / liquid / gas) [1]

Kelly poured 100 ml of orange juice into glass A and glass B respectively.



glass A



glass B

The volume of orange juice is the same in each glass but its shape is different.

- (b) Based on the information, state a property of the orange juice as shown above. [1]
-

SCORE	3
-------	---

38 Sharon set up an experiment where she filled a measuring beaker to 40 cm^3 with dry sand as shown below in Figure 1. Then, she poured 60 cm^3 of water into the measuring beaker with the sand as shown in Figure 2.

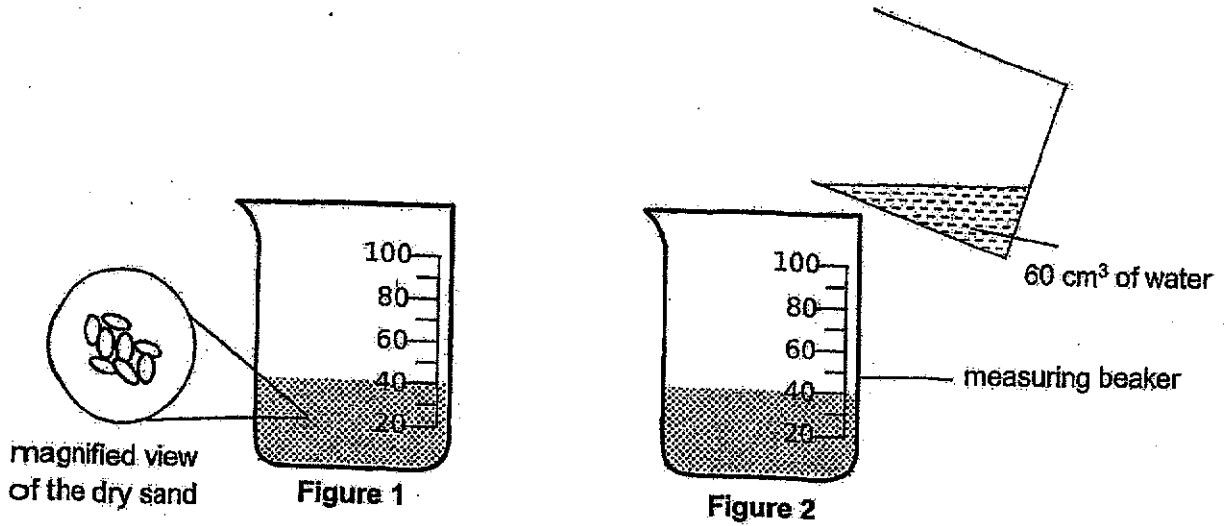

(a) What is the total volume of the mixture of water and sand in the measuring beaker in Figure 2? Tick (✓) the correct box. [1]

- 100 cm^3
- between 40 cm^3 and 100 cm^3
- more than 100 cm^3

(b) Explain your answer in (a). [1]

(continues on next page)

SCORE	2
-------	---

- (c) Sharon placed four different objects inside four identical empty containers. Then, she poured water into each container to the brim as shown below.

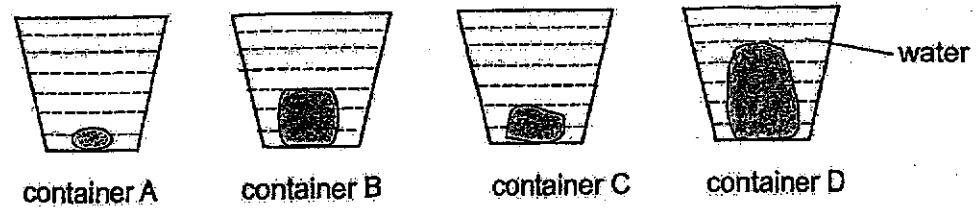

Which container, A, B, C or D has the least volume of water poured into it?
Explain your answer. [1]

- 39 Mrs Lee boiled some soup in a pot as shown below.

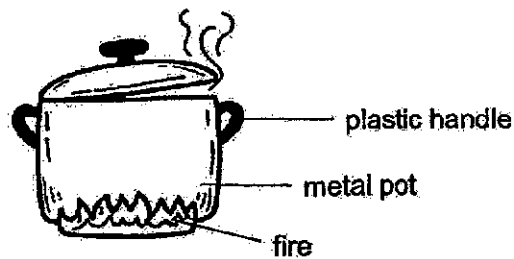

- (a) (i) The handle is made of plastic because it is a _____ conductor of heat. [1]
- (ii) The pot is made of metal because it is a _____ conductor of heat. [1]
- (b) Mrs Lee turned off the fire and she observed that the temperature of the soup in the pot decreased after half an hour. Give a reason for her observation. [1]

SCORE	4
-------	---

- 40 Fatimah had two similar containers, A and B which were made of different materials. She placed 100 ml of cold water into each container and inserted a thermometer into each container as shown below.

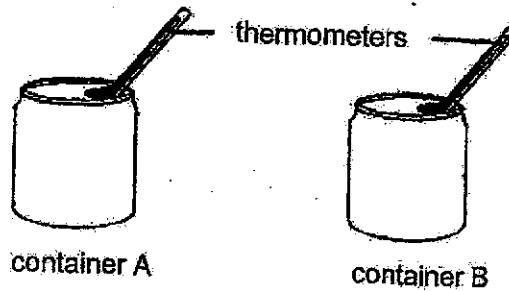

She left the containers on a table in the classroom and recorded the temperature of the water every 10 minutes. Her results are shown in the table below.

Time (minutes)	Temperature of the water ($^{\circ}\text{C}$)	
	Container A	Container B
0	5	5
10	9	14
20	13	20
30	17	25
40	21	28
50	25	28
60	28	28

- (a) Based on the table, state the temperature of the surroundings in the classroom. [1]

- (b) Fatimah wanted to bring a container of cold juice for her picnic. Based on her experiment, which container, A or B should Fatimah use to keep her juice cold for a longer time? Explain your answer. [2]

END OF PAPER

SCORE	3
-------	---

1 2

ST. HILDA'S PRIMARY SCHOOL
PRIMARY 4
END-OF-YEAR EXAMINATION, 2024
SCIENCE
Simplified Answer Key

Booklet A

1.	1	6.	2	11.	3	16.	4	21.	4	26.	4
2.	2	7.	4	12.	3	17.	3	22.	2	27.	2
3.	2	8.	4	13.	2	18.	2	23.	3	28.	3
4.	3	9.	3	14.	2	19.	2	24.	2		
5.	4	10.	2	15.	3	20.	3	25.	4		

Booklet B

29(a)	fish / plant / snail
(b)	air bubble / air pump / rock / water / air / glass tank
(c)	There was <u>not enough air in the water</u> for the fish to stay alive.
(d)	The fish <u>reproduce</u> .
(e)	Living things <u>respond to changes</u> .
	(a) A (b) D (c) B , E
31(a)	S. The <u>amount of undigested food decreased the most</u> . <u>Most digestion takes place in the small intestine</u> .
(b)	<u>Chewing the food thoroughly breaks down the food into smaller pieces</u> . It increases the <u>exposed surface area of the food in contact with the digestive juices</u> . <u>Digestion will be faster</u> .
32(a)	Three stages: chicken, grasshopper Four stages: butterfly, beetle
(b)	W: adult; X: egg; Y: larva; Z: pupa
(c)	Adult stage. The adult mosquito will be <u>flying</u> in the air and no longer in the water so it is harder to catch.
33(a)	Strength
(b)	R. It can hold the <u>least amount of weights</u> before breaking.
(c)	S. It can hold the <u>most amount of weights</u> before breaking. Material S is the <u>strongest</u> . When she uses material S to make her bag, <u>her bag will not break when she uses it to carry her books</u> .

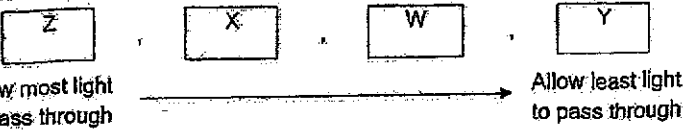
34(a)	<table border="1"> <thead> <tr> <th data-bbox="480 405 756 439">Variables</th> <th data-bbox="756 405 983 439">Kept the same</th> <th data-bbox="983 405 1209 439">Changed</th> </tr> </thead> <tbody> <tr> <td data-bbox="480 439 756 472">shape of magnet</td> <td data-bbox="756 439 983 472"></td> <td data-bbox="983 439 1209 472"></td> </tr> <tr> <td data-bbox="480 472 756 551">distance between magnet and pins</td> <td data-bbox="756 472 983 551"></td> <td data-bbox="983 472 1209 551"></td> </tr> <tr> <td data-bbox="480 551 756 584">material of pins</td> <td data-bbox="756 551 983 584"></td> <td data-bbox="983 551 1209 584"></td> </tr> <tr> <td data-bbox="480 584 756 618">length of magnet</td> <td data-bbox="756 584 983 618"></td> <td data-bbox="983 584 1209 618"></td> </tr> </tbody> </table>	Variables	Kept the same	Changed	shape of magnet			distance between magnet and pins			material of pins			length of magnet		
Variables	Kept the same	Changed														
shape of magnet																
distance between magnet and pins																
material of pins																
length of magnet																
(b)	Steel / iron / nickel / cobalt															
(c)	The magnet is the strongest at its poles.															
35(a)	The <u>light</u> from the lamp is <u>reflected</u> by the cat and enters Jane's eye.															
(b)	A shadow is formed when the <u>path of light is blocked</u> by an object.															
36(a)																
(b)	Material Y, It allows <u>no light to pass through</u> . This shows that material Y is <u>opaque</u> and it will <u>block out light</u> completely when used as a blackout curtain.															
37(a)	(i) liquid. (ii) solid															
(b)	The orange juice <u>does not have a definite shape</u> .															
38(a)	between 40 cm ³ and 100 cm ³															
(b)	The <u>water will occupy the air spaces</u> between the sand particles.															
(c)	Container D. The <u>object has the biggest volume</u> .															
39(a)	(i) poor (ii) good															
(b)	The <u>soup lost heat to its surroundings</u> .															
40(a)	28°C.															
(b)	Container A. The temperature of water in container A <u>increased slower</u> than that of container B. This shows that container A is a <u>poorer conductor of heat</u> . The cold juice in container A will <u>gain heat slower</u> from its surrounding and be kept cold for a longer time.															