



HENRY PARK PRIMARY SCHOOL
END OF THE YEAR EXAMINATION 2023

PRIMARY 4

SCIENCE

SECTION A (56 MARKS)

INSTRUCTIONS TO CANDIDATES

1. Do not turn over this page until you are told to do so.
2. Follow all instructions carefully.
3. Answer all questions.
4. Shade your answers on the Optical Answer Sheet (OAS) provided.

Name: _____ ()

Class: Primary 4 ()

Date: 26 October 2023

Total Time for Booklets A and B: 1 h 45 min

Sections	Marks
A	/ 56
B	/ 44
Total	/ 100

Parent's Signature: _____



Section A (56 marks)

For each question from 1 to 28, four options are given. One of them is the correct answer. Make your choice (1, 2, 3 or 4). Shade the correct oval (1, 2, 3 or 4) on the Optical Answer Sheet.

1. Cecilia wants to measure the temperature of hot water in a beaker.

Which one of the following diagrams shows the correct position of the thermometer when taking the temperature reading?

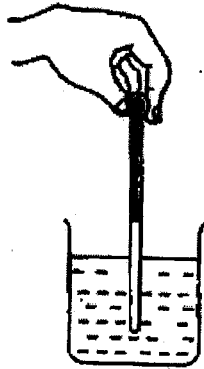

(1)

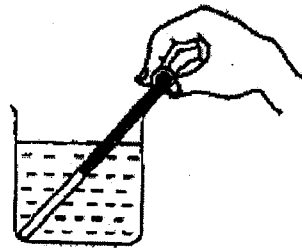

(2)

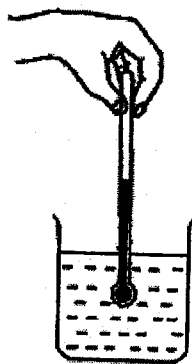

(3)

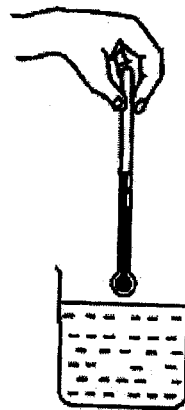

(4)

2. Which one of the following is the best conductor of heat?

- (1) A metal cup
- (2) A paper cup
- (3) A plastic cup
- (4) A ceramic cup

3. Look at the picture below.

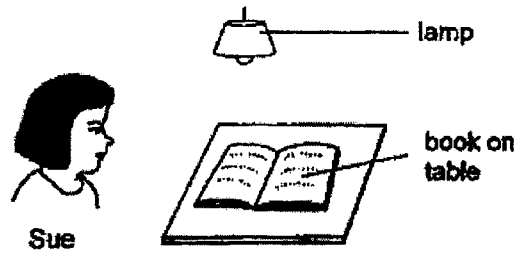

Which one of the following explains why Sue can see the book on the table?

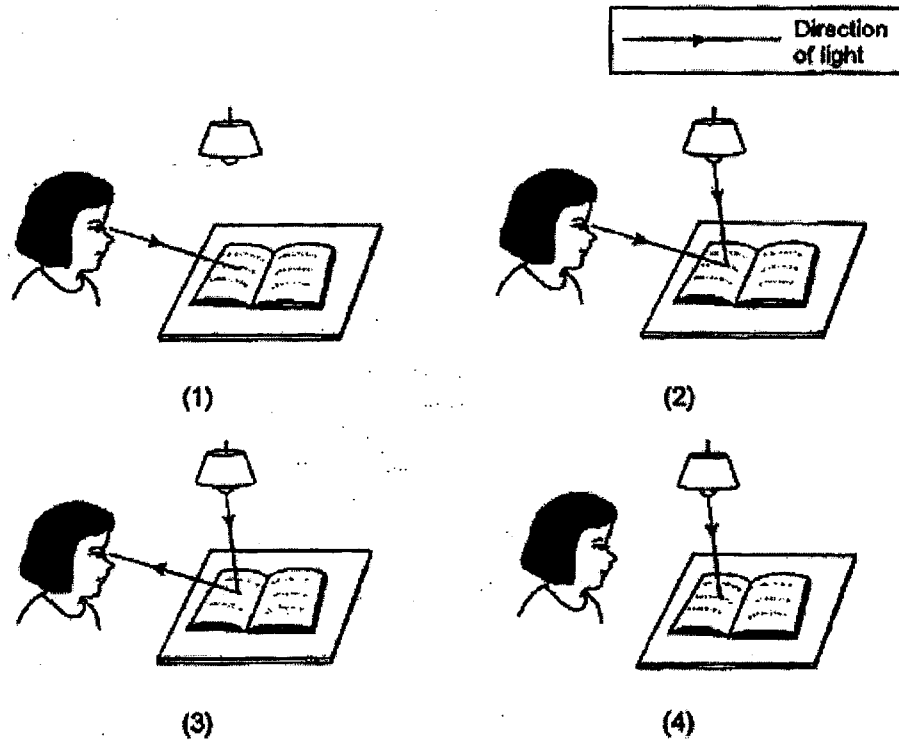

4. Which one of the following can be attracted by a magnet?

- (1) iron rod
- (2) glass rod
- (3) plastic rod
- (4) wooden rod

5. The diagram shows a painting hanging on a wall.

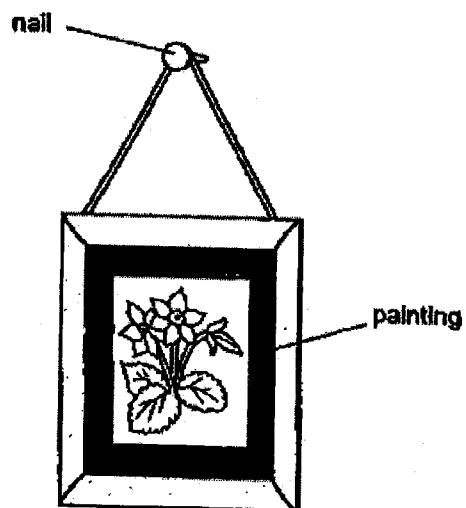

Steel is used to make nails because it _____

- (1) is shiny
- (2) is strong
- (3) is magnetic
- (4) sinks in water

6. In the diagram, what is the volume of liquid X?

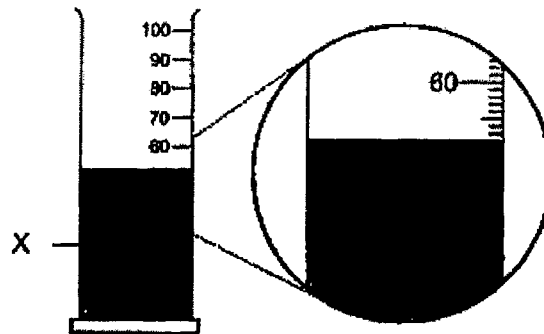

- (1) 50 ml
- (2) 52 ml
- (3) 60 ml
- (4) 65 ml

7. Which animal has a pupa as a stage in its life cycle?

- (1) frog
- (2) chicken
- (3) mosquito
- (4) grasshopper

8. In which part of the digestive system is digested food absorbed into the blood?

- (1) mouth
- (2) stomach
- (3) large intestine
- (4) small intestine

9. The arrows (→) in the diagram below show the direction of movement of a substance in plants.

roots → stem → leaves

What is this substance?

- (1) soil
- (2) food
- (3) water
- (4) seed

10. Which animal is NOT a reptile?

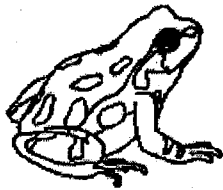

(1)



(2)



(3)

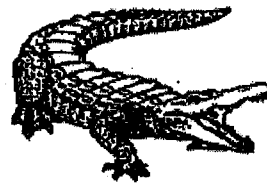

(4)

11. Study the flowchart below.

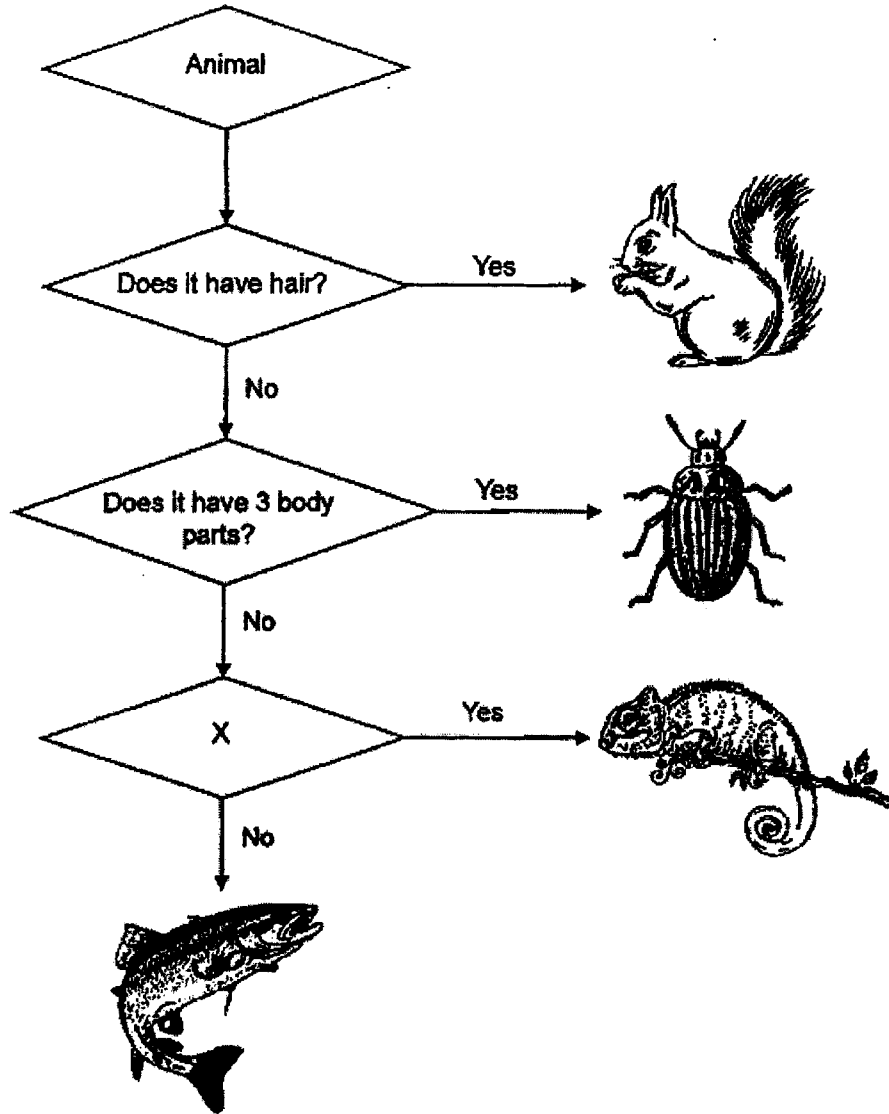

Which of the following is a possible question for X?

- (1) Does it lay eggs?
- (2) Does it live on land?
- (3) Does it have scales?
- (4) Does it live in water?

12. Which of the following living things reproduces by seeds?



(1)



(2)



(3)



(4)

13. The diagrams below show the life cycles of insects W and Z.

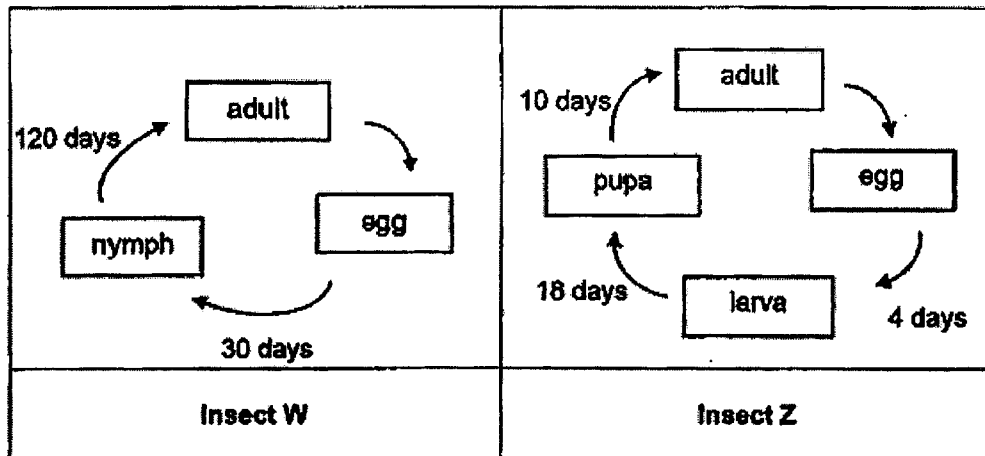

Based on the diagrams above, which of the following statements are not correct?

- A Both insects reproduce by laying eggs.
- B Insect Z takes a longer time to develop from egg to adult.
- C The higher the number of stages in the life cycle, the longer the time taken for an egg to develop into an adult.

- (1) A and B only
- (2) B and C only
- (3) A and C only
- (4) A, B and C

14. Jerry planted green bean seeds in two open plates X and Y. He placed both plates X and Y by the window but plate Y was placed in a black box as shown below.

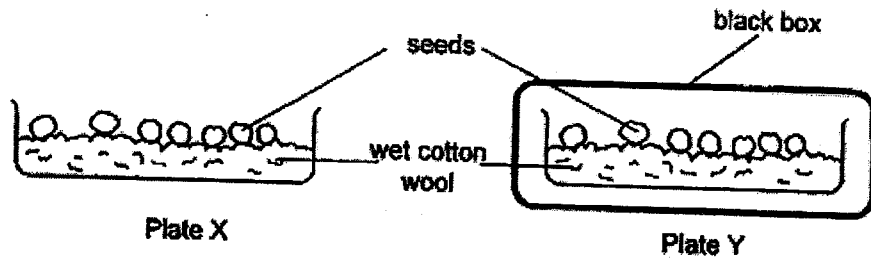

Based on his experimental set-up shown above, what was the aim of his experiment?

- (1) To find out if light is needed for seeds to grow.
- (2) To find out if water is needed for a seed to make food.
- (3) To find out if presence of light affects the height of the seedling.
- (4) To find out if presence of water affects the height of the seedling.

15. Sam used a hammer to hit the iron nail into the wall.

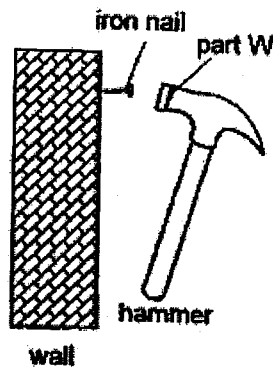

Which of the following correctly states the properties of part W?

	strong	flexible
(1)	no	no
(2)	no	yes
(3)	yes	yes
(4)	yes	no

16. Kumar wanted to find out which materials, W, Y and Z, are magnetic. He prepared the set-ups as shown below.



He held the same bar magnet above each set-up as shown below and made the following observations.

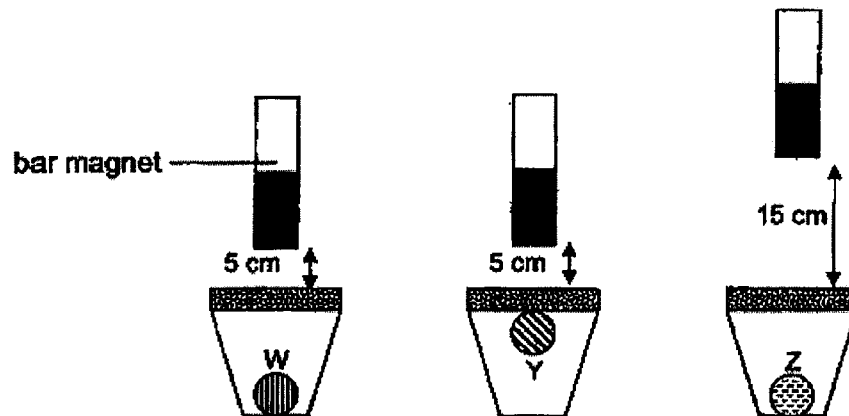

Based on his observations, which of the following best describes the magnetic property of materials W, Y and Z?

Is the material magnetic or non-magnetic?			
	Magnetic	Non-magnetic	Not possible to tell
(1)	Y	W	Z
(2)	Y	Z	W
(3)	W	Y	Z
(4)	Z	Y	W

17. The diagram shows a model train used in a Science project.

Bars AB and CD are used to help the train "float" above the base as shown in the diagram below.

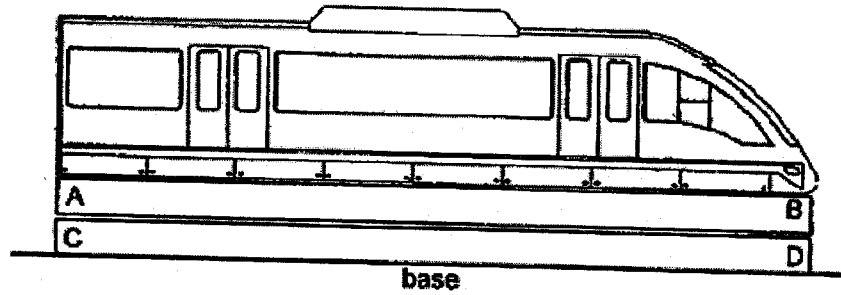

Which of the following shows the magnetic poles of bars AB and CD?

	A	B	C	D
P	N — S		N — S	
Q	N — S		S — N	
R	S — N		N — S	
S	S — N		S — N	

- (1) P only
 (2) Q only
 (3) P and S only
 (4) R and S only

18. The diagram below show a compass.

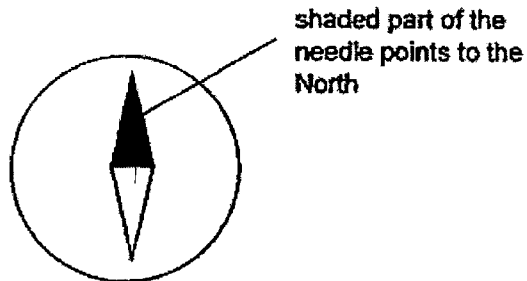

Four bar magnets were arranged such that they are attracted to one another. A compass was then placed near the end P and the direction of the compass needle is as shown below.

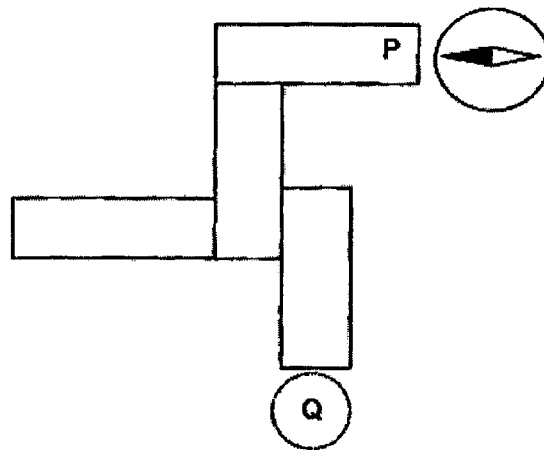

What would be the direction of the needle when the compass was placed at Q?



19. Study the electromagnet shown below.

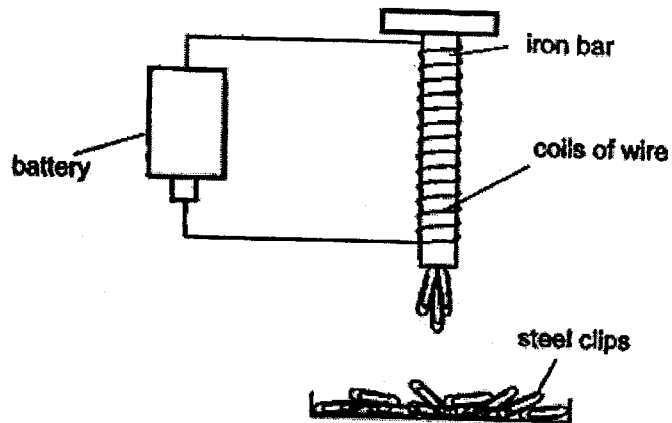

Which one of the following actions would reduce the number of steel clips attracted to the electromagnet?

- (1) move the electromagnet nearer to the tray
- (2) increase the number of steel clips in the tray
- (3) connect another battery to the electromagnet
- (4) coil less turns of the wire around the iron bar

20. The diagram below shows a bird trying to drink water from a cup.

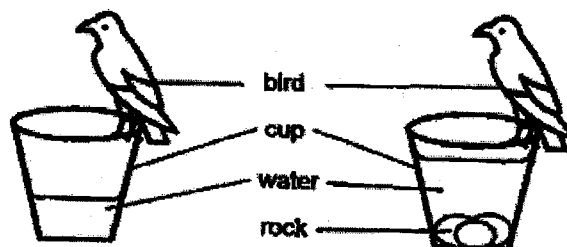

The bird drops rocks into the cup until the water level rises to the top. Which of the following can be concluded from the rise in water level?

- (1) Solids have mass.
- (2) Solids occupy space.
- (3) Solids have fixed shape.
- (4) Solids have no fixed volume.

21. Study the diagrams below carefully.

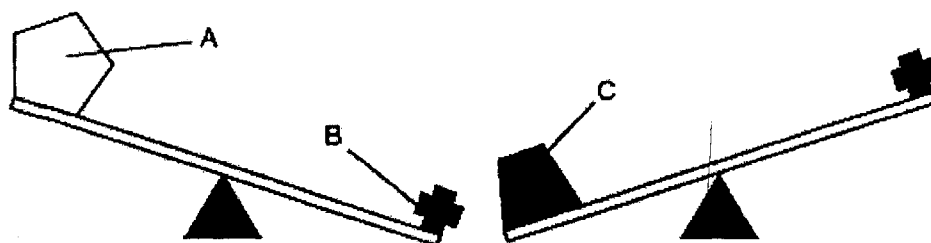

A, B and C are blocks made from the same material. Sarah then placed A, B and C in a measuring cylinder filled with water.

She recorded her observations in the table below.

Object	Initial volume of water before object is placed in the measuring cylinder (ml)	Final volume of water with object placed in the measuring cylinder (ml)
A	50	80
B	50	59
C	50	75

Which of the following is correct?

	Largest Mass	Smallest Volume
(1)	B	B
(2)	B	C
(3)	C	B
(4)	C	A

22. The diagram shows a fully inflated bouncy castle. The volume of the bouncy castle when it is fully inflated is 500 cm^3 .

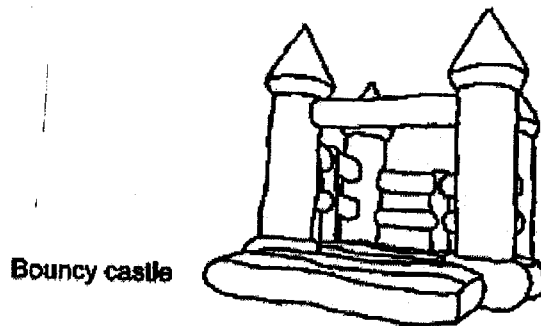

Air is pumped into a deflated bouncy castle until it is fully inflated.

Which graph accurately shows the change in the volume of air?

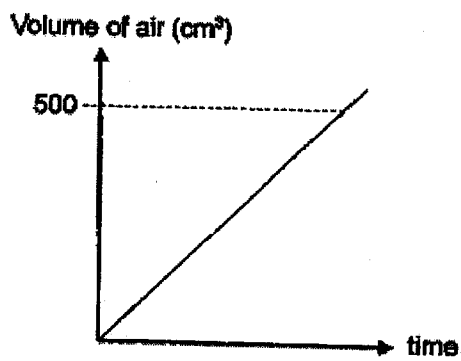

(1)

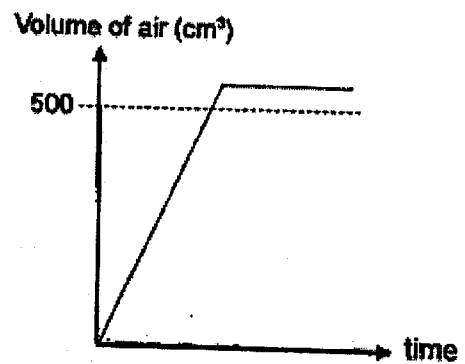

(2)

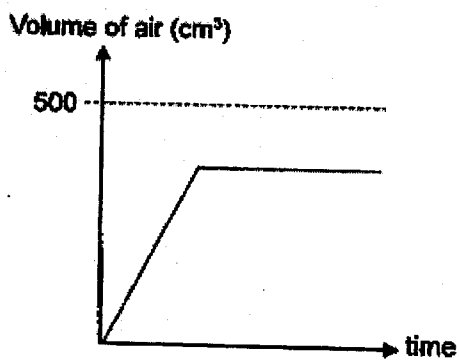

(3)

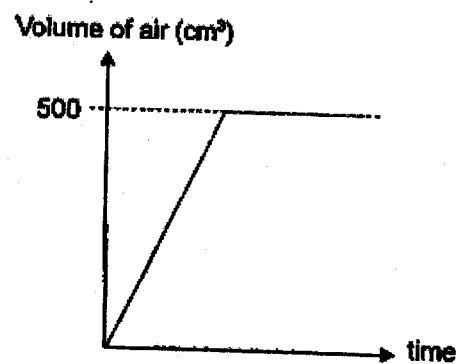

(4)

23. The diagram below shows a metal rod being supported by two wooden blocks. Four similar pieces of wax, K, L, M and N, were attached to the rod. A heat source was then placed on the table below the metal rod.

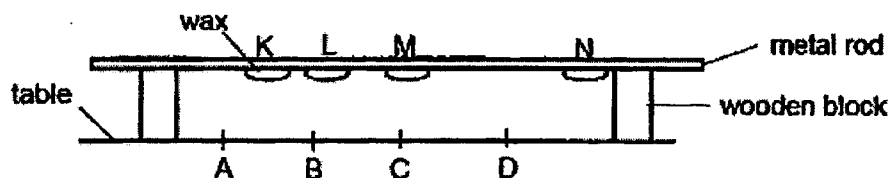

The order in which the wax pieces fell from the rod was recorded in the table below.

Wax	Time taken for the wax pieces to fall from the rod(s)
K	40
L	28
M	17
N	63

At which position, A, B, C or D, on the table was the heat source placed?

- (1) A
- (2) B
- (3) C
- (4) D

24. Alison was eating ice cream in a cup, using a spoon to scoop the ice cream into her mouth.

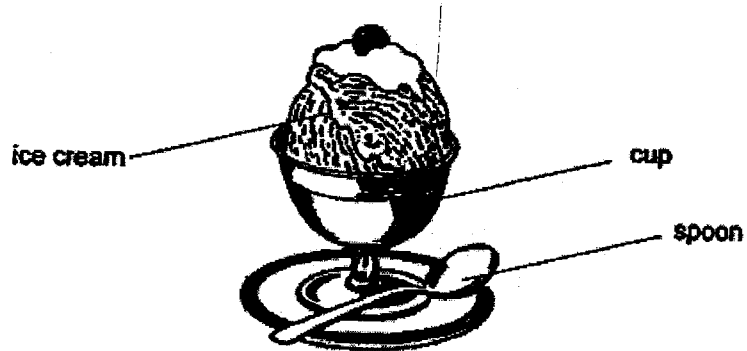

Which of the following about the heat transfer between the cup, ice cream and Alison is correct?

	Ice cream	Cup	Alison's mouth
(1)	gained heat	lost heat	lost heat
(2)	gained heat	gained heat	lost heat
(3)	lost heat	lost heat	gained heat
(4)	lost heat	gained heat	gained heat

25. Evan poured the same volume of water from cups E and F into an empty cup G as shown in the diagram below.

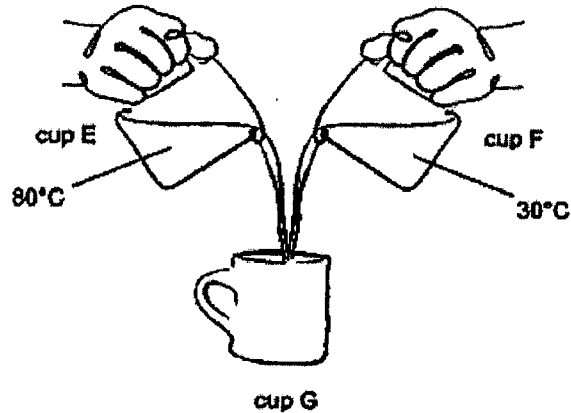

Which of the following is most likely the temperature of water in cup G right after the water is poured?

- (1) 28 °C
 - (2) 30 °C
 - (3) 55 °C
 - (4) 110 °C
26. Four metal blocks were heated to a temperature of 80°C. Each block was dropped into a beaker of water. Each beaker contained a different amount of water, at a different temperature, as shown below.

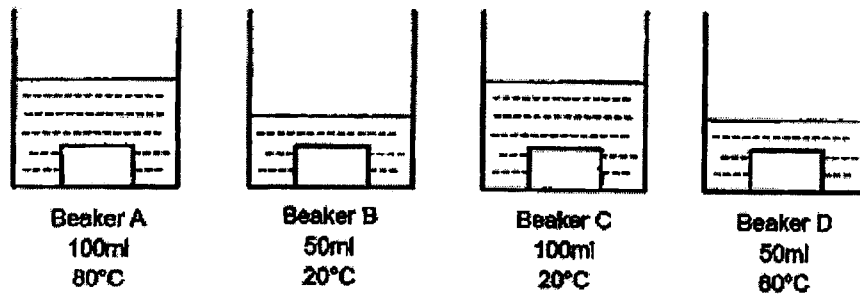

In which beaker would the water show the largest increase in temperature?

- (1) A
- (2) B
- (3) C
- (4) D

27. Derek tried to form different shadows of object X by using a torchlight and a screen.

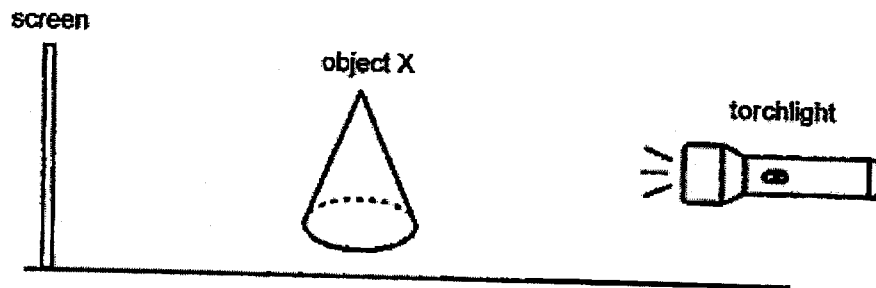

Which one of the following shadows cannot be formed by object X on the screen?

(1)



(2)

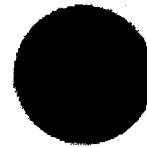

(3)



(4)



28. One night, Alan walked from point A to C, passing a lamp post at point B as shown in the diagram below.

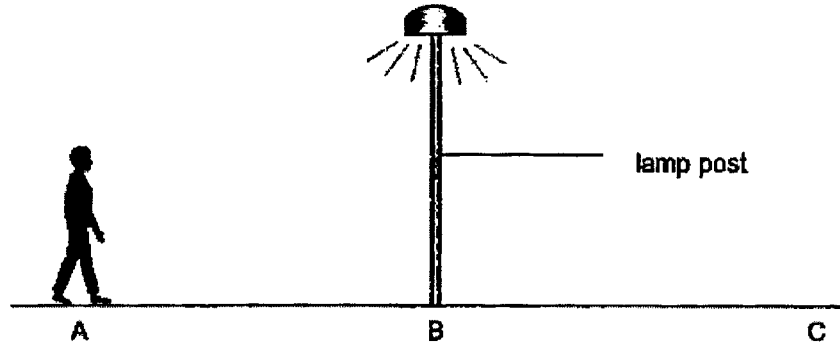

If the only light source nearby was the lamp post, which one of the graphs below shows how the length of Alan's shadow changes from points A to C?

(1)

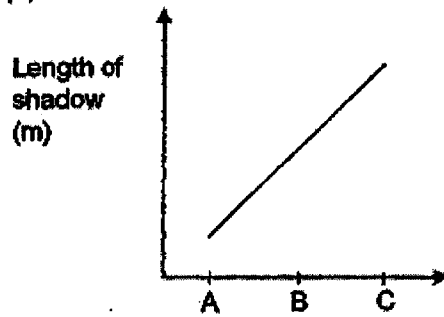

(2)

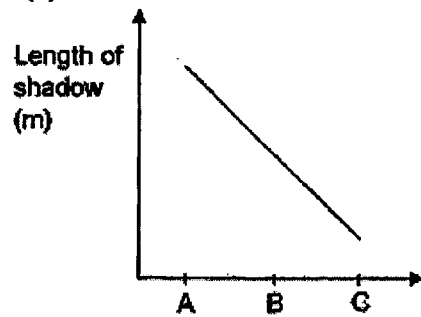

(3)

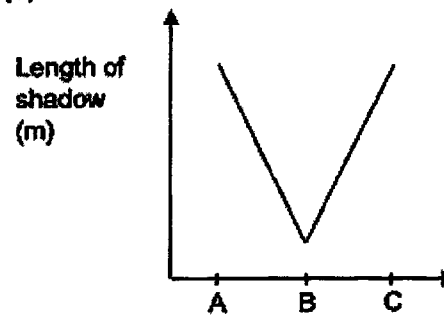

(4)

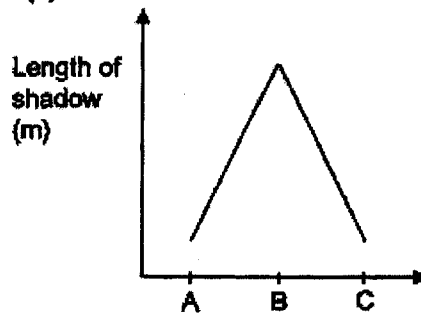

End of Booklet A



HENRY PARK PRIMARY SCHOOL
END OF THE YEAR EXAMINATION 2023

PRIMARY 4

SCIENCE

SECTION B (44 MARKS)

INSTRUCTIONS TO CANDIDATES

1. Do not turn over this page until you are told to do so.
2. Follow all instructions carefully.
3. Answer all questions.

Name: _____ ()

Class: Primary 4 ()

Date: 26 October 2023

Total Time for Booklets A and B: 1 h 45 min

Marks for Section B: _____

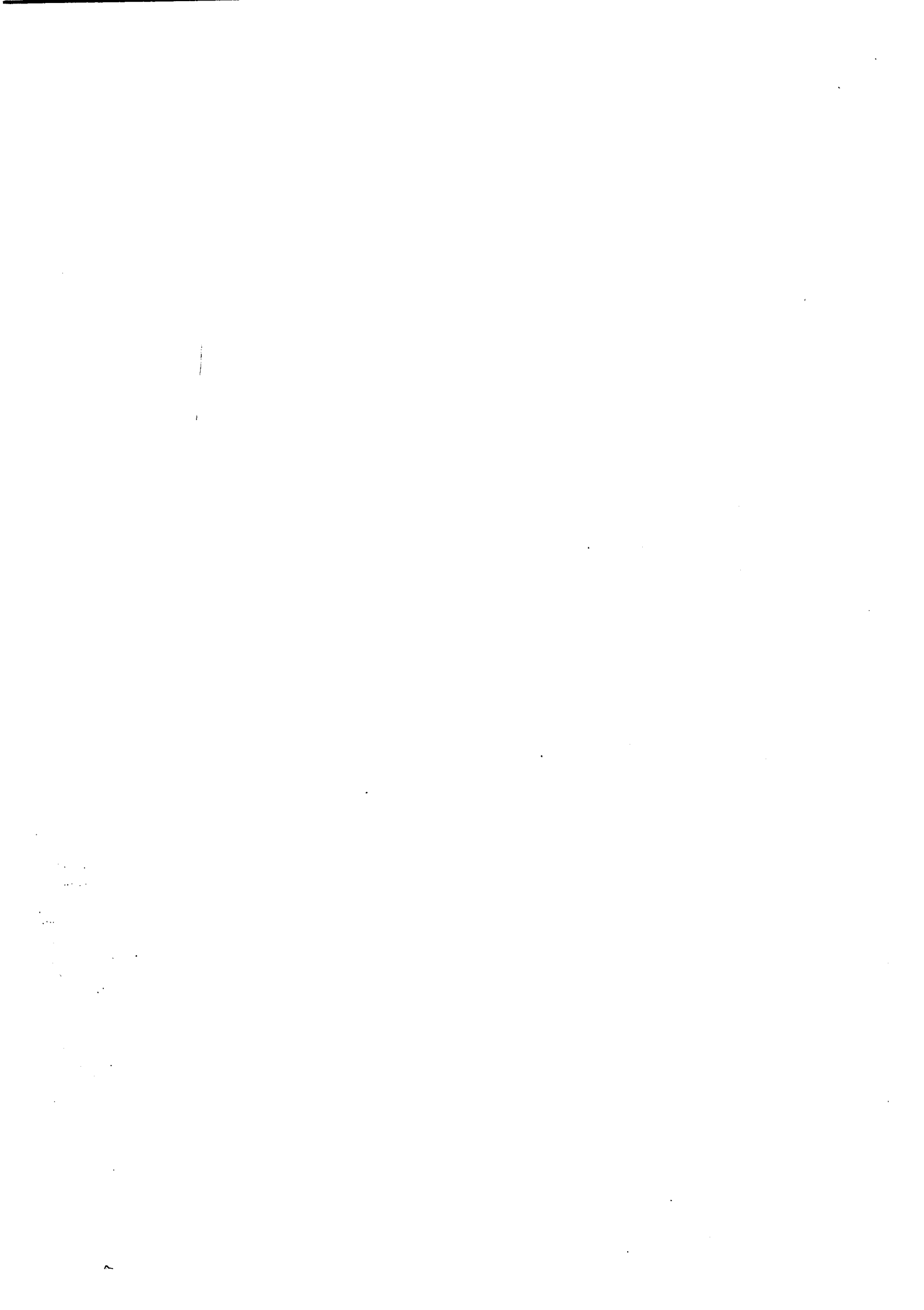

Section B (44 marks)

For questions 29 to 41, write your answers in the space provided.

The number of marks available is shown in brackets [] at the end of each question or part question.

29. Jill observed and grouped some things as shown in the table.

G	H
lion	marble
earthworm	umbrella
mushroom	pencil

What are the suitable headings for G and H?

[2]

Group G - _____

Group H - _____

30. Draw lines to match the three organ systems to their functions.

[3]

organ systems

functions

respiratory system ●

circulatory system ●

skeletal system ●

● supports our body and gives it shape

● breaks down food into simpler substances

● takes air into and out of the body

● transports digested food, water and oxygen to all parts of the body

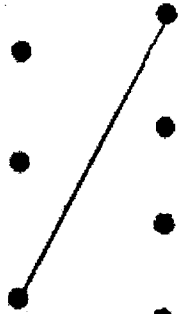

31. Tick (✓) in the box if each of the following has a definite shape and / or a definite volume. [3]

		has definite shape	has definite volume
(a)	milk	<input type="checkbox"/>	<input type="checkbox"/>
(b)	plastic bottle	<input type="checkbox"/>	<input type="checkbox"/>
(c)	air	<input type="checkbox"/>	<input type="checkbox"/>

32. Look at the pictures. Tick (✓) the sources of light. [2]

mirror

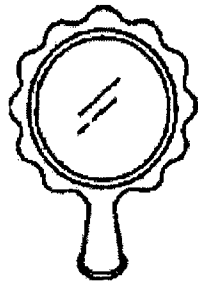

eyes



fire



lamp

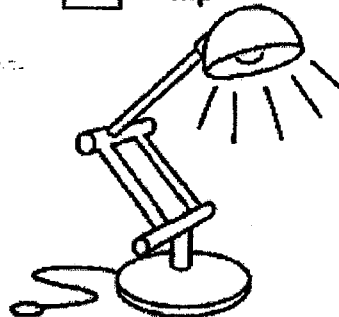

33. John placed four similar plants in identical jars, each containing water at the same level as shown in the diagram below.

He then placed all the plants next to the window for an hour.

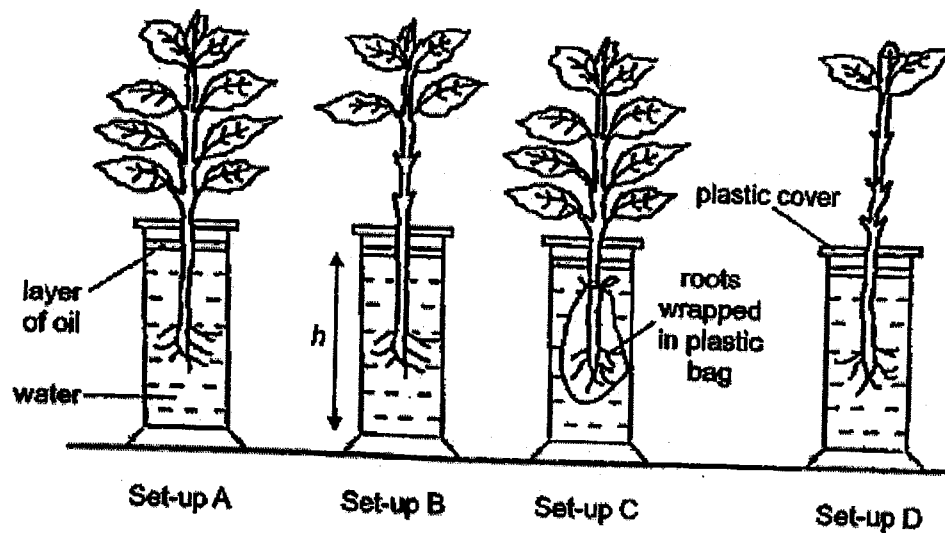

- (a) Which two set-ups should be compared to show that the roots of the plant absorb water? Give a reason for your answer. [2]

- (b) John conducted another experiment using set-ups A and B. He measured the height of water level, h , for both set-ups at the end of the experiment. What was John trying to find out from this experiment? [1]

- (c) State another function of the roots. [1]



34. Study the classification diagram below.

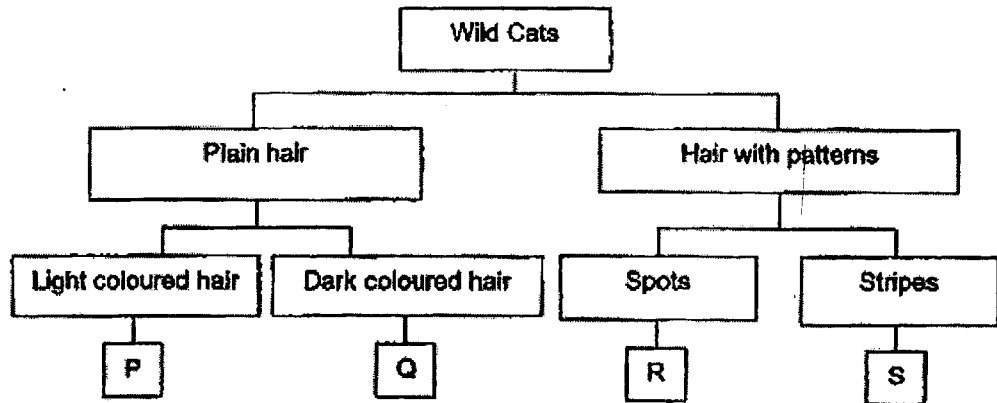

The diagram below shows a type of wild cat.

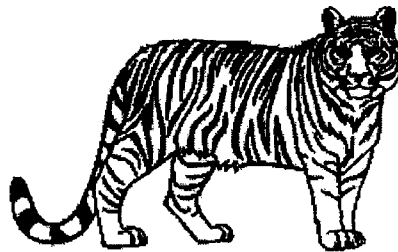

(a) Which animal, P, Q, R or S, represents the wild cat shown above? _____ [1]

(b) Which animal group do wild cats belong to? Suggest 2 reasons for your answer. [1]

(c) Based only on the information given in the classification diagram, state two similarities between animals Q and R. [1]

Similarity 1:

Similarity 2:



Question 34 continued

The diagram below shows animal W.

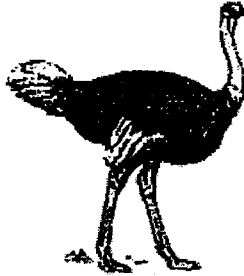

- (d) State if animal W can be placed in the classification diagram given.
Explain your answer.

[1]



35. Study the table below carefully.

	Characteristic			
	Has legs	Can swim	Able to breathe in water	Lays eggs
Animal P		✓	✓	✓
Animal Q	✓	✓		✓

A tick (✓) indicates the presence of the characteristic.

Use only the information given in the table above to answer the questions below.

- (a) State two similarities between animals P and Q. [1]

- (b) Based on the information given above, Maran concluded that animal Q is definitely an insect.
Do you agree with Maran? Explain your answer. [1]

- (c) Animal Q does not live in the water. Suggest a reason for this. [1]



36. There were 3 chairs made of different materials. Goldilocks wanted to find out if the type of material affects the strength of the chair.

She placed some weights on them and measured the number of 5-kg weights the chairs could hold before they broke. She carried out the experiment three times for each chair.

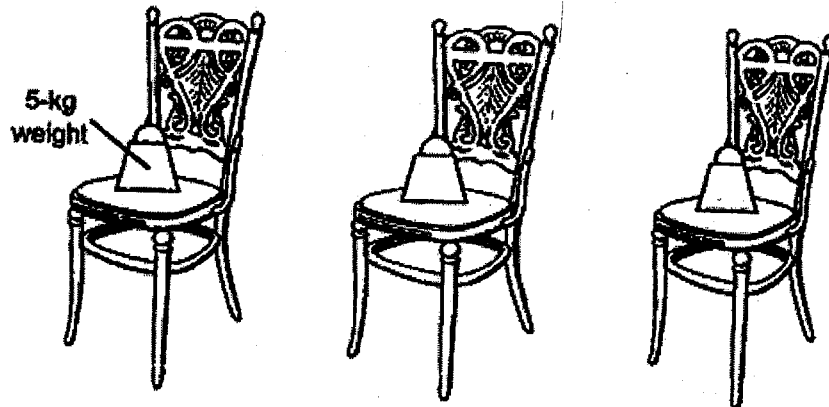

She recorded her observations in the table below.

Material	Number of weights on the chair before it broke		
	Trial 1	Trial 2	Trial 3
A	4	5	3
B	7	9	7
C	2	1	1

- (a) Based on the above results, which material, A, B or C, is most suitable for making a bookshelf? [2]
Explain your answer.

- (b) State the variable Goldilocks changed in this experiment. [1]

- (c) Suggest why Goldilocks carried out the experiment thrice for each material. [1]



37. Rebecca placed a piece of tissue at the bottom of a cup and turned the cup over.

Next, she placed the cup in a basin of water as seen in the diagram below. She observed that the tissue paper remained dry.

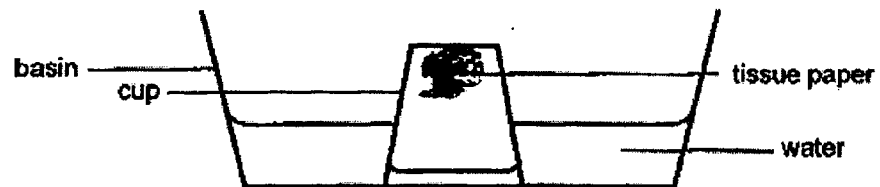

(a) Explain why the tissue paper remained dry. [2]

Rebecca decided to poke some holes at the base of the cup as seen in the diagram below.

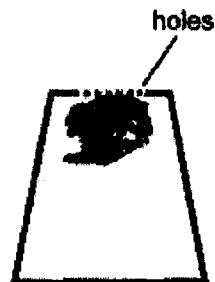

(b) Draw the water level that Rebecca would observe in the diagram below. [2]

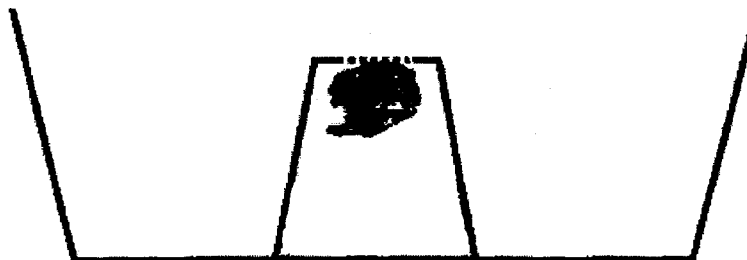

38. Jun Kai had two glasses, P and Q, that were stuck together. He tried taking them apart using his hands but was unable to do so. He then placed both glasses in a basin as shown in the diagram below.

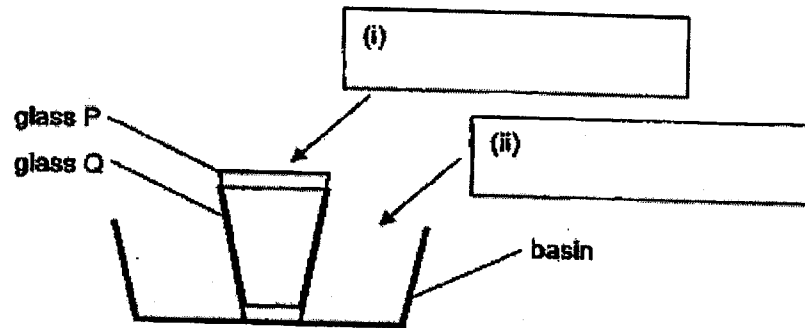

Jun Kai decided to add hot water and ice cubes to the above set-up to separate the two glasses.

- (a) Fill in the boxes (i) and (ii) in the above diagram with hot water or ice-cubes correctly so that the two glasses can be separated easily. [2]
- (b) Explain your answers in (a). [2]

box (i):

box (ii):



39. Roger conducted an experiment using four rods of equal length and thickness but made of different materials, P, Q, R and S.

A pea was attached to the end of each rod using the same amount of wax.

The four rods were attached to a metal container filled with hot water that heats up each rod as shown in the diagram below.

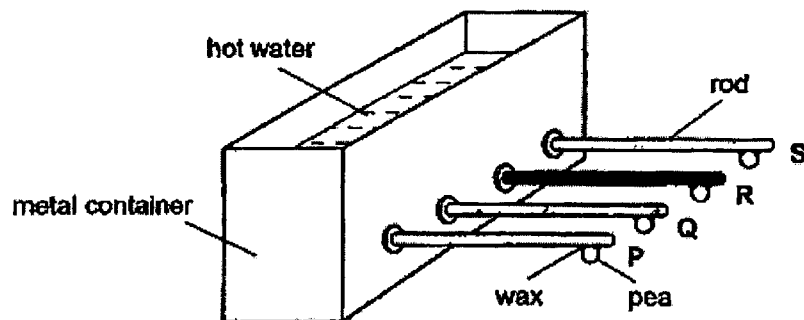

The time was recorded for the pea to fall from each rod as shown in the table below.

Material of rod	Time taken for pea to fall (s)
P	30
Q	65
R	100
S	80

- (a) Arrange the four materials P, Q, R and S, starting from the poorest conductor of heat. [1]

Poorest conductor of heat → → → Best conductor of heat



Question 39 continued

(b) Which of the following variables should be kept the same to ensure a fair experiment? Tick (✓) the correct variable(s). [1]

(i) material of the rod

(ii) amount of wax added to each rod

(iii) distance between hot water and pea

Roger wanted to use a frying pan to fry an egg safely.



(c) Based on the results of his experiment, which material P, Q, R and S should be used to make the handle of the frying pan? [2]

Explain why.



40. Isaiah placed three rectangular sheets of different materials, X, Y and Z, in a straight line as shown below.

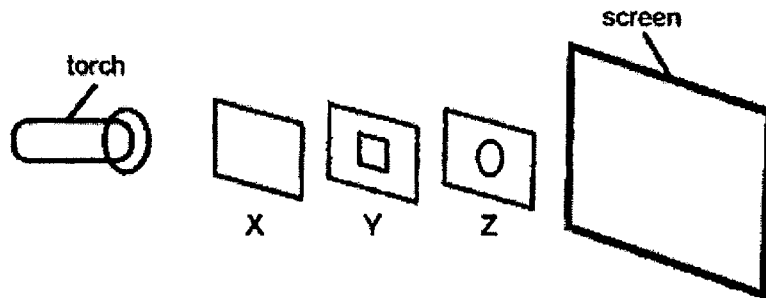

A square was cut out in the centre of Y and a circle was cut out in the centre of material Z as shown in the diagram below.

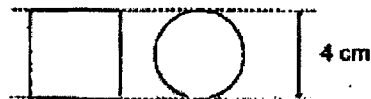

When the torch was switched on, a shadow was projected onto the screen as shown below.

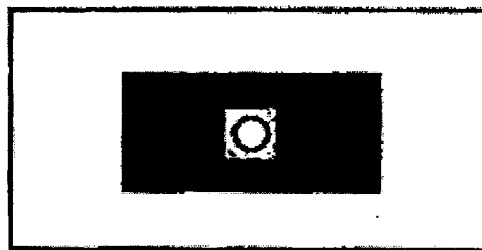

- (a) State how a shadow is formed. [1]

- (b) Which material allows [1]

(i) most light to pass through? _____

(ii) least light to pass through? _____



Question 40 continued

Isaiah needed to wear a pair of sunglasses to protect his vision, so that he could see objects without hurting his eyes on sunny days.

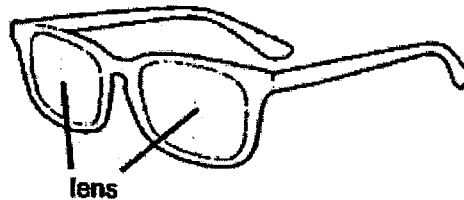

- (c) Based on the answer given in (b), which of the materials X, Y, or Z, is most suitable for making the lens of the sunglasses? [2]

Explain why.



41. The diagram below shows a bag of potato chips.



(a) Name the 2 states of matter found inside the bag. [1]

(b) The mass of the bag of potato chips is 150 grams. [1]
Will the mass of the potato chips be greater than, equal to or less than 150 grams?

(c) Explain your answer in (b). [1]

End of Booklet B



SCHOOL : HENRY PARK PRIMARY SCHOOL
LEVEL : PRIMARY 4
SUBJECT : SCIENCE
TERM : SA2 2023

CONTACT :

Q 1	Q2	Q3	Q4	Q5	Q6	Q7	Q8	Q9	Q10
3	1	3	1	2	2	3	4	3	1
Q 11	Q12	Q13	Q14	Q15	Q16	Q17	Q18	Q19	Q20
2	2	2	1	4	1	3	2	4	2
Q 21	Q22	Q23	Q24	Q25	Q26	Q27	Q28		
3	4	3	1	3	2	3	3		

QN	4G Correction Sheet for P4 SA2
33 a)	A and C. The <u>only changed variable</u> is whether the roots come in contact with <u>water</u>
b)	To find out how amount of <u>leaves</u> affect the amount of water taken in by the plants / roots.
c)	To anchor the plant to the ground firmly.
34 a)	S
b)	Mammals . They have hair / give birth to young alive / they feed their <u>young with milk (any 2)</u>
c)	Both animals are wild cats. Both animals have hair.
d)	No. Explanation: Animal W is not a wild cat. Animal W is a bird OR Animal W has feathers OR Animal W lays eggs OR Animal W has 2 legs.
35 a)	Both animals P and Q can swim and reproduce by laying eggs .
b)	No, he needs to confirm that the number of <u>legs</u> animal Q has is 6 .
c)	It is not able to <u>breathe</u> in the water as It does not have gills or moist skin.
36 a)	Material B. It withstood the most number of weights on the chair before it broke. / It is the strongest material so it will be able to hold the <u>greatest number</u> of books on the bookshelf.
b)	type of material
c)	To improve the reliability of the results
37 a)	There was air occupying the space inside the cup . Air was not able to <u>escape</u> / was trapped inside the cup. This prevents the water from taking up more <u>space</u> in the cup / the water from displacing the air in the cup.
b)	
38 a)	(i) ice cubes (ii) hot water
b)	The glass cup P <u>loses</u> <u>heat</u> to the ice and <u>contracts</u> . The glass cup Q <u>gain</u> <u>heat</u> from the hot water and <u>expands</u> .
39 a)	R, S, Q, P
b)	(ii) and (iii)
c)	Material R . Material R is the poorest conductor of <u>heat</u> . The time taken for the pea to fall is the <u>longest</u> . The handle will conduct heat the slowest / from the flame to the hands.
40 a)	A shadow is formed when <u>light is blocked</u> by an object.
b)	(i) <u>Material X</u> (ii) <u>Material Y</u>
c)	Z . Z blocks <u>some light</u> from entering from entering his eyes so that his eyes were not get hurt.
41 a)	Gas and solid
b)	Less than 150 grams
c)	Air / gas has mass.