

SINGAPORE CHINESE GIRLS' SCHOOL (PRIMARY)

SECOND SEMESTRAL ASSESSMENT 2019

NAME: \_\_\_\_\_ ( )

DATE: 22 October 2019

CLASS: PRIMARY 4 SY / C / G / SE / P

Parent's Signature:

\_\_\_\_\_

SCIENCE  
BOOKLET A

28 questions

56 marks

Total time for Booklets A & B: 1 h 45 min

**DO NOT OPEN THIS BOOKLET UNTIL YOU ARE TOLD TO DO SO.**

**FOLLOW ALL INSTRUCTIONS CAREFULLY.**



**Part I (56 marks)**

For each question from 1 to 28, four options are given. One of them is the correct answer. Make your choice (1, 2, 3 or 4). **Shade the correct oval (1, 2, 3 or 4) on the Optical Answer Sheet.**

1. Which one of the following statements is true for **ALL** insects?

- 1) They have tails.
- 2) They have wings.
- 3) They live on land.
- 4) They have six legs.

2. Which one of the following objects is **not** made of waterproof material?

1)

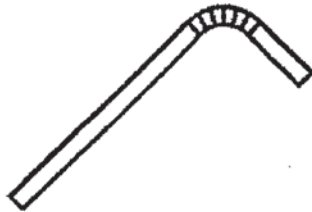

Metal straw

3)

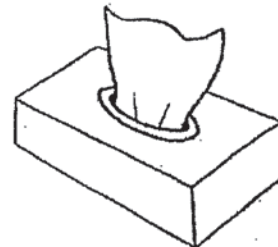

Tissue paper

2)



Rubber boots

4)



Plastic cup

3. Which one of the following substances has a fixed shape?

- 1) oil
- 2) rock
- 3) oxygen
- 4) milk

4. Which one of the following is the best conductor of heat?

- 1) paper ruler
- 2) metal ruler
- 3) plastic ruler
- 4) wooden ruler

5. The diagram below shows the life cycle of an animal.

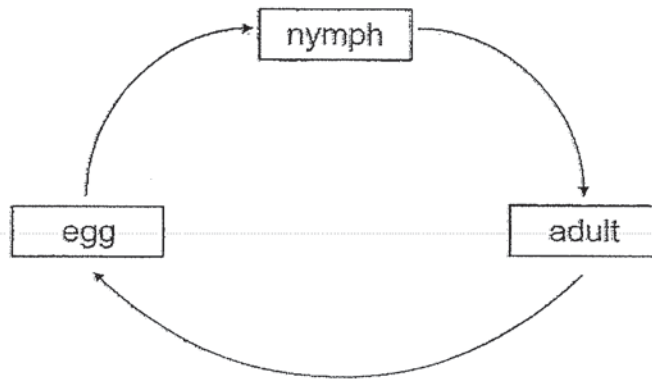

Which animal is likely to have the life cycle as shown above?

- |           |              |
|-----------|--------------|
| 1) duck   | 3) butterfly |
| 2) beetle | 4) cockroach |

6. Study the chart below.

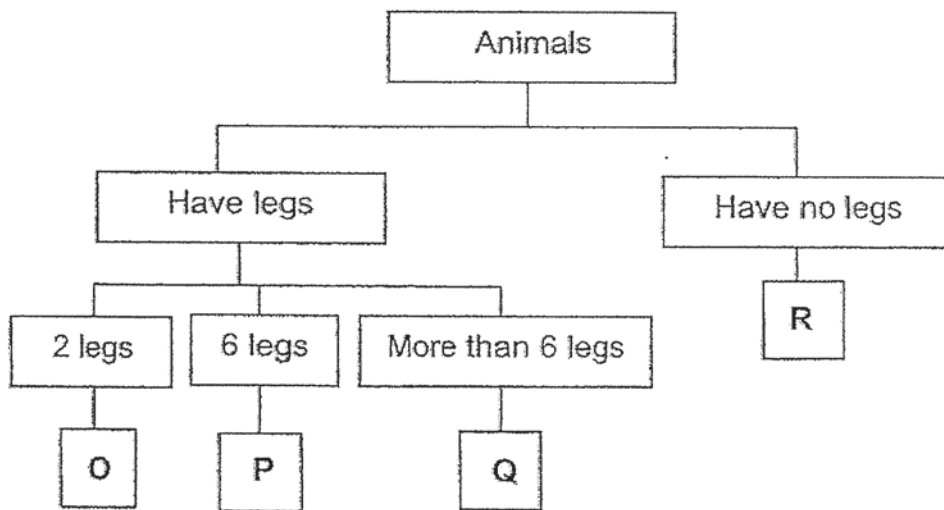

Where would you put this animal in the chart above?

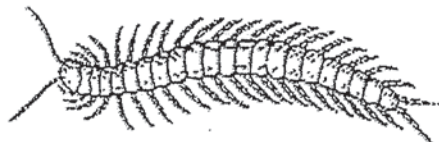

- |      |      |
|------|------|
| 1) O | 3) Q |
| 2) P | 4) R |

7. Look at the picture below.

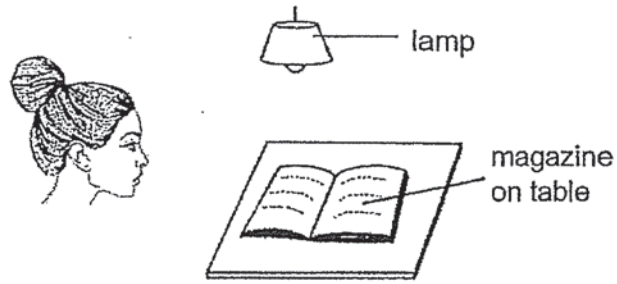

Which one of the following explains why Mary can see the book on the table?

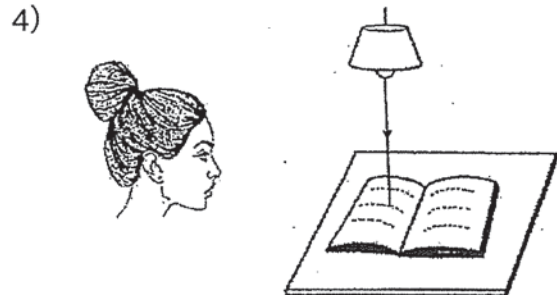
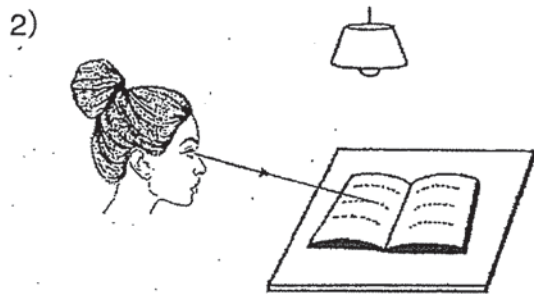
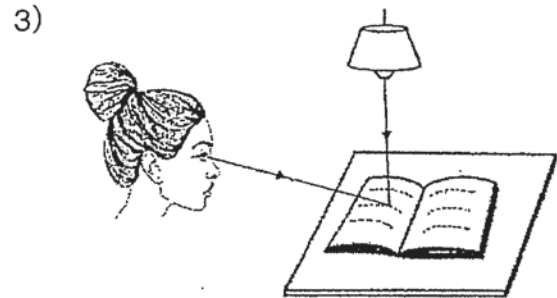
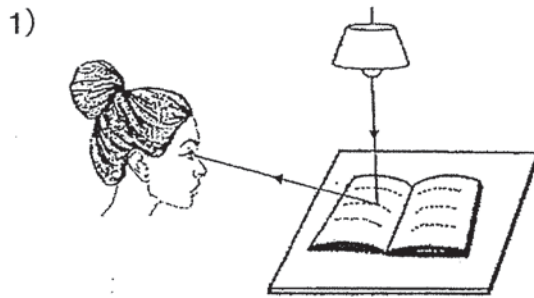
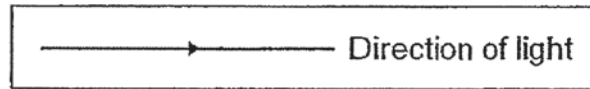

8. Which one of the following is **NOT** a source of heat?

- 1) The Sun
- 2) Lighted bulb
- 3) Burning coal
- 4) Woollen jacket

9. The set-up below shows light shining on a baseball.



screen



baseball

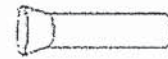

torch

Which one of the following would likely be seen on the screen?

1)

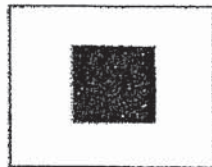

3)

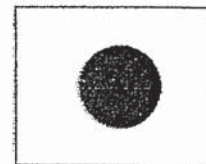

2)

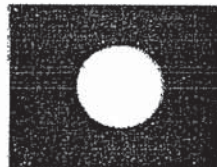

4)

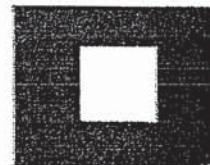

10. Jian An observed four items, A, B, C and D, and recorded their characteristics in the table below. A tick indicates that the item has the described characteristic.

Items	Able to reproduce	Able to respond to changes	Able to make food	Able to move from one place to another
A		✓		
B		✓		✓
C		✓		✓
D	✓	✓	✓	

Based on the information above, how many living things are there in the classification table above?

- 1) 1
- 2) 2
- 3) 3
- 4) 4

11. Fahan found that the stem of the plant below has been cut.



Which one of the following is most likely to be the observation made two weeks later?

- 1) The leaves wither from lack of water.
- 2) The plant will grow taller and start to bear fruits.
- 3) The plant will not be able to stand upright and fall.
- 4) The roots wither from lack of food and water.

12. Aminah tested two magnets, Y and Z, as shown in this diagram below.

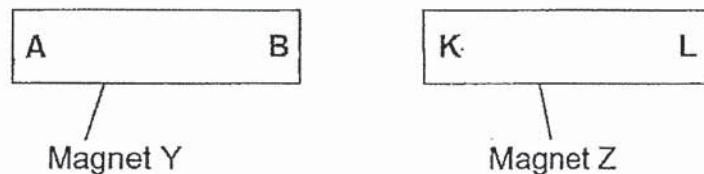

She was surprised by the results as shown below.

Poles placed near each other	Attract	Repel
A and K	✓	
A and L	✓	
B and K	✓	
B and L	✓	

What could have possibly gone wrong with her investigation?

- A: Magnet Z could have been kept in oil.  
 B: Magnet Z could have been demagnetised.  
 C: Magnet Y could have been heated over a fire.  
 D: Magnet Y could have been hammered or dropped many times.

- 1) A and B only
- 2) B and C only
- 3) C and D only
- 4) B, C and D only

13. The diagram below shows the life cycle of a tomato plant.

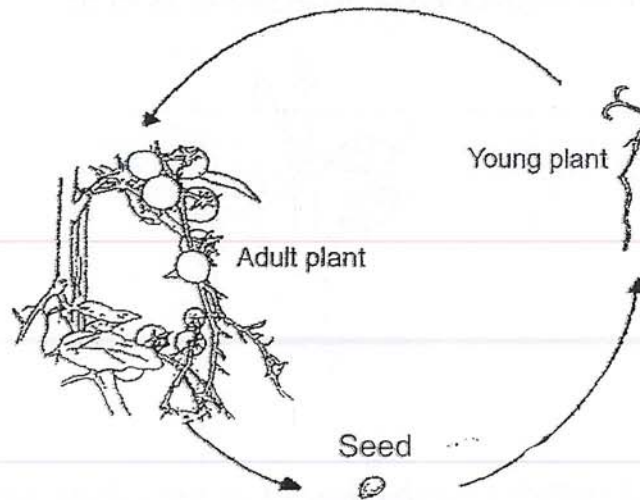

Which one of the following statements is **not true** of the life cycle of the tomato plant?

- 1) Every tomato plant has the same life cycle.
- 2) The life cycle of the tomato plant is made up of three stages.
- 3) The life cycle of the tomato plant ensures the continuity of its kind.
- 4) Light is needed for every stage of the tomato plant's life cycle.

14. Paul carried out an experiment. He set up a bottle and a funnel as shown below. He poured the water quickly into the funnel but the water did not enter the air-tight bottle. Which of the following best explains why water could not enter the air-tight bottle?

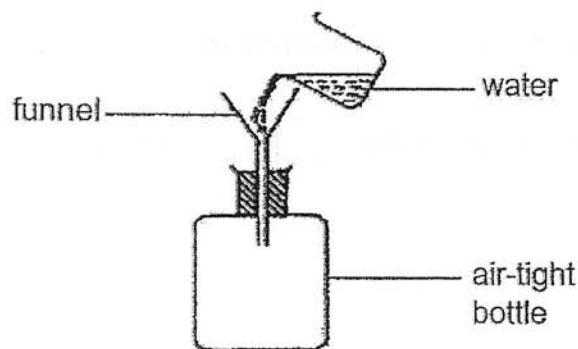

- 1) water has mass
- 2) air occupies space
- 3) air cannot be compressed
- 4) water takes the shape of the container



15. Pillai wanted to find out the amount of light that passes through three liquids, E, F and G, respectively. He shone a torch at each liquid and used a datalogger to measure the amount of light that passed through each liquid.

He recorded the readings in the table below.

Liquid E	Liquid F	Liquid G
23,000 units	50,000 units	0 units

Which one of the following shows what Liquids E, F and G represent correctly?

	Liquid E	Liquid F	Liquid G
1)	milk	coffee	tap water
2)	tap water	tea	coffee
3)	tea	tap water	milk
4)	milk	coffee	tap water

16. The diagram below shows a piece of cork floating in a trough of water.

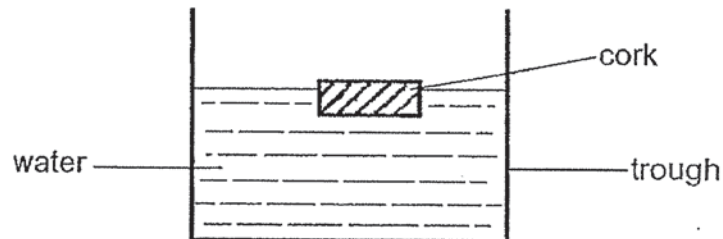

Without tilting, a cup is inverted over the cork and held down. Which one of the following diagrams show what could happen to the cork and water?

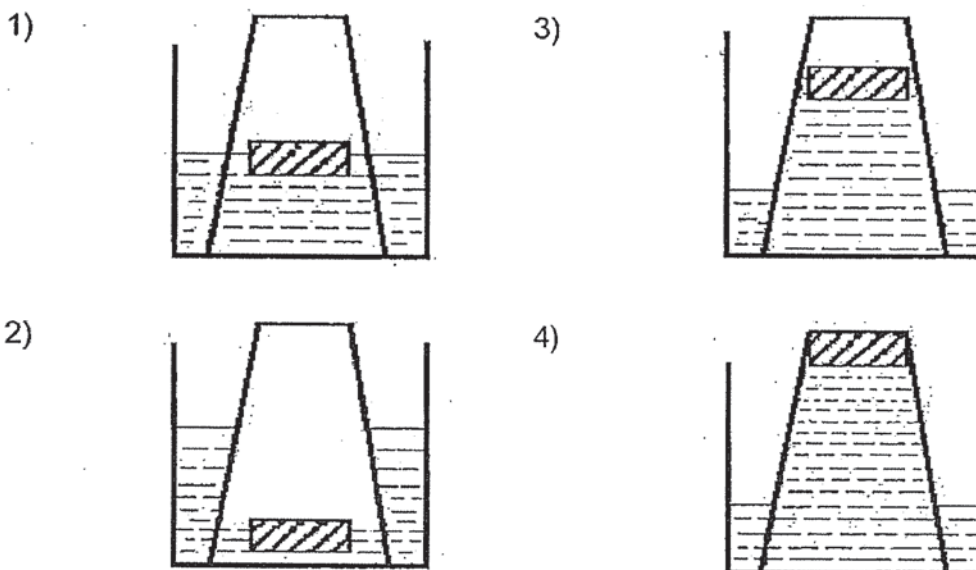

17. Materials are selected for specific uses based on their properties. Which one of the following shows the **incorrect** property for the given object and material?

	Material	Property	Object
1)	glass	transparent	spectacles
2)	plastic	waterproof	container
3)	ceramic	flexible	vases
4)	steel	strong	forks

18. Ali placed a packet of tea into a cup without overflowing as shown below.

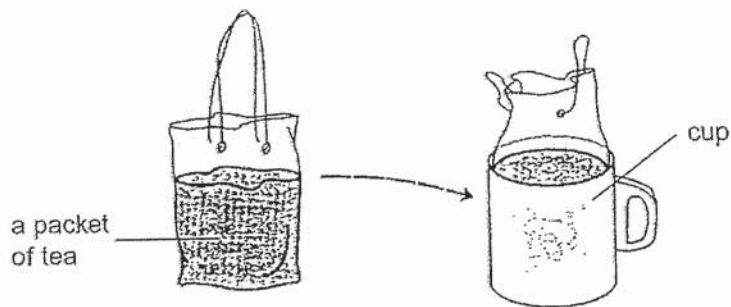

Which one of the following about the packet of tea is correct?

- 1) Both the shape and the volume of the tea did not change.
- 2) The shape of the tea changed but the volume did not.
- 3) The volume of the tea changed but the shape did not.
- 4) Both the shape and the volume of the tea changed.

19. Study the diagrams below.

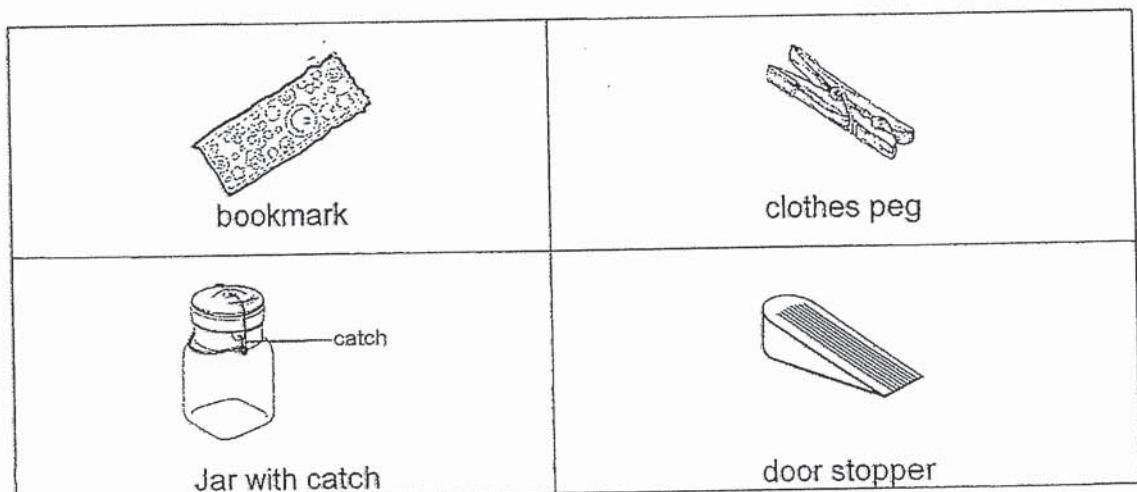

Which object(s) is/are a system?

- 1) bookmark and jar
- 2) clothes peg and door stopper
- 3) jar and clothes peg
- 4) bookmark and door stopper

20. Tim has four containers filled fully with oil. Each container was heated to a temperature as shown below.

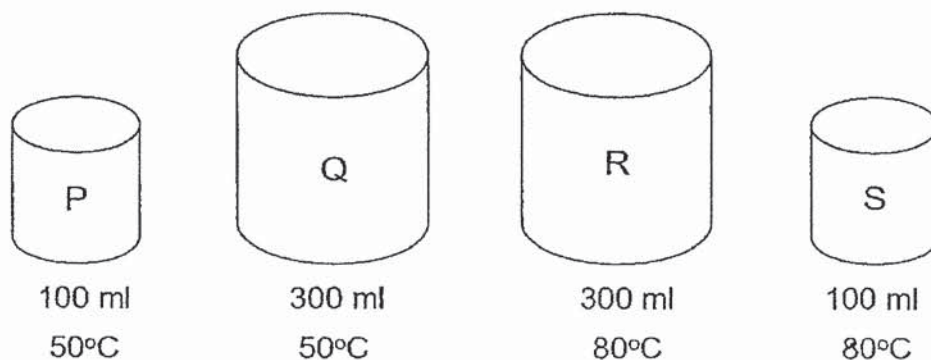

Which of the statements is **true**?

- 1) R and S have the same amount of heat.
- 2) P and S have the same amount of heat.
- 3) Q has less heat than S.
- 4) R has more heat than S.

21. To demonstrate that light travels in a straight line, Issac used 3 boards like the one shown below.

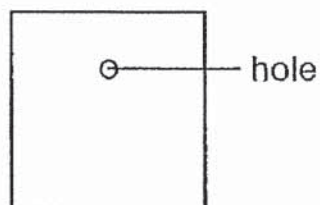

To carry out his experiment, Issac must \_\_\_\_\_.

- A: use boards of the same size
- B: use boards made of opaque material
- C: use boards made of transparent material
- D: place a light source or an object at one end of the three boards

- 1) A and B only
- 2) B and D only
- 3) C and D only
- 4) A, B and D only

22. Study the classification table below.

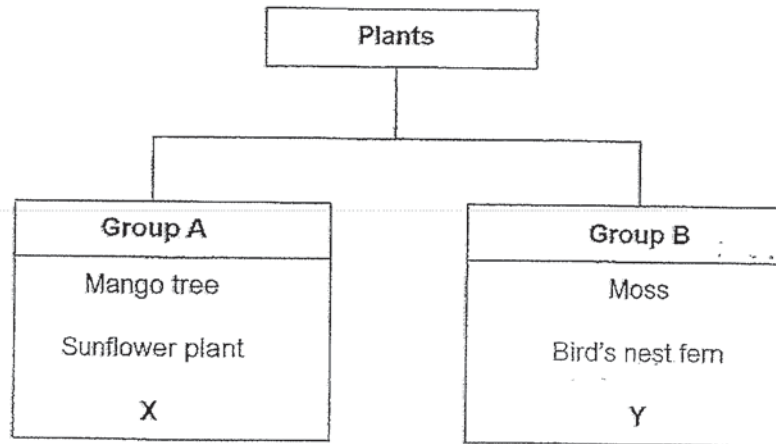



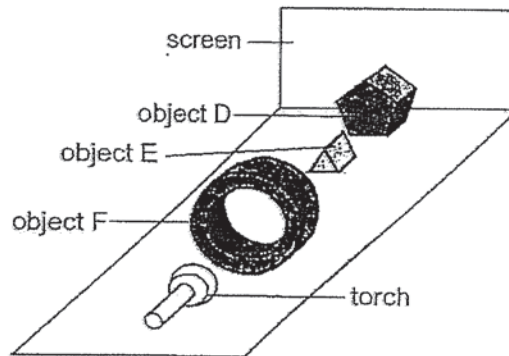

Which plants can X and Y be?

	X	Y
1)	Hibiscus plant	Grass
2)	Carnation plant	Dragon scale fern
3)	Mushroom	Rose plant
4)	Staghorn fern	Ladder fern

23. Three opaque objects, D, E and F, are placed one in front of the other and a torch is shone on them from the front as shown below.



Which one of the following shadows is most likely to be seen on the screen?

- 1)  3) 
- 2)  4) 

24. In cold countries, houses have windows that are constructed using two pieces of glass panes as shown below.

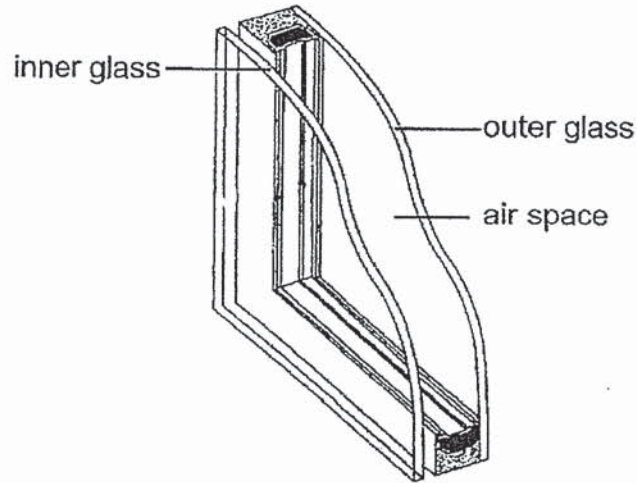

Which one of the following shows how the windows keep the house warm on a cold day?

	Materials	Type of heat conductor	Conduction of heat from house to outside of house
1)	glass	good	faster
2)	air	good	slower
3)	air	poor	slower
4)	glass	poor	faster

25. The temperature of a glass of milk was measured and found to be at 55°C. It was left on the table for 12 minutes in SCGS canteen which had a room temperature of 30°C. The temperature of the milk was measured again. What would the temperature of milk likely be?

- |         |         |
|---------|---------|
| 1) 20°C | 3) 55°C |
| 2) 30°C | 4) 75°C |

26. Amos filled two identical syringes completely, one with air and one with oil. Then he covered them with black paper as shown in the diagram below.

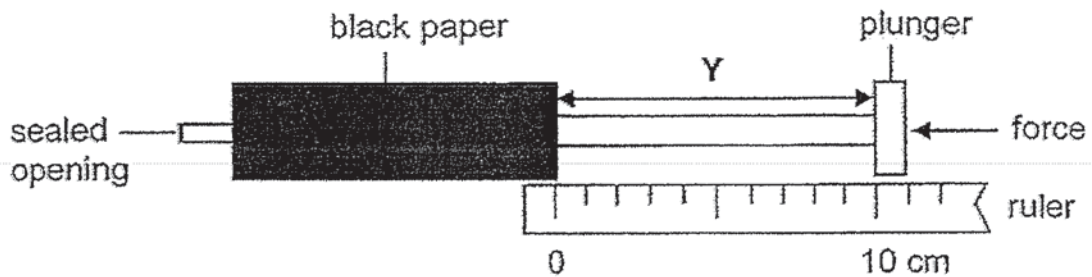

He then pushed each plunger as hard as he could and measured **Distance Y**. Which one of the following shows the correct values of Y?

	Syringe with Air (Y / cm)	Syringe with Oil (Y / cm)
1)	10	0
2)	0	10
3)	4	10
4)	10	4

27. The diagram below shows a young plant.

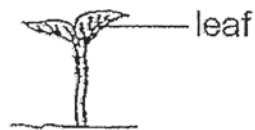

The leaf helps the plant to \_\_\_\_\_.

- |                 |                    |
|-----------------|--------------------|
| 1) make food    | 3) absorb water    |
| 2) grow upright | 4) absorb nutrient |

28. Xiao Yun conducted an experiment to investigate the amount of light that passes through four objects as shown below.

Object
Clear glass
Aluminum foil
Tracing paper
Frosted glass

The graph below shows the amount of light recorded by the light detector for the four objects.

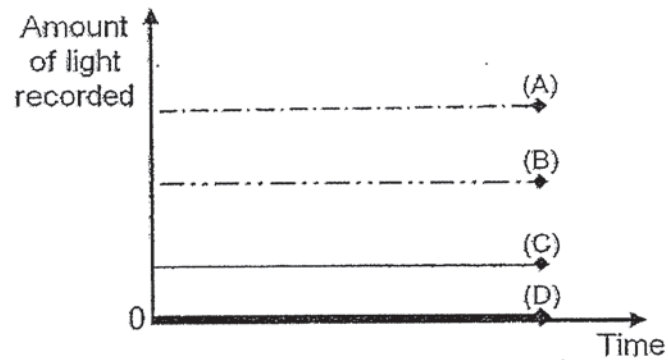

Which line, A, B, C or D, shows the results for aluminium foil?

- 1) A
- 2) B

- 3) C
- 4) D

~ End of Booklet A ~





SINGAPORE CHINESE GIRLS' SCHOOL (PRIMARY)

SECOND SEMESTRAL ASSESSMENT 2019

NAME: \_\_\_\_\_ ( )

DATE: 22 October 2019

CLASS: PRIMARY 4 SY / C / G / SE / P

Parent's Signature:

\_\_\_\_\_

SCIENCE

BOOKLET B

	Total Actual Marks	Total Possible Marks
Booklet A		56
Booklet B		44
Total		100

13 questions

44 marks

Total time for Booklets A & B: 1 h 45 min

**DO NOT OPEN THIS BOOKLET UNTIL YOU ARE TOLD TO DO SO.**

**FOLLOW ALL INSTRUCTIONS CAREFULLY.**

**Part II (44 marks)**

Answer all the following questions.

29. The diagram below shows a frying pan.

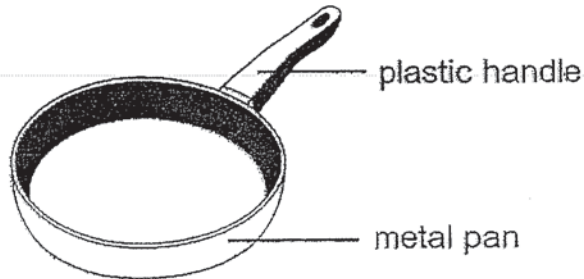

- a) The handle is made of plastic because it is a \_\_\_\_\_ conductor of heat. [1]
- b) The pan is made of metal because it is a \_\_\_\_\_ conductor of heat. [1]
- c) The diagram below show a cup containing some hot water, a tea bag and a spoon.

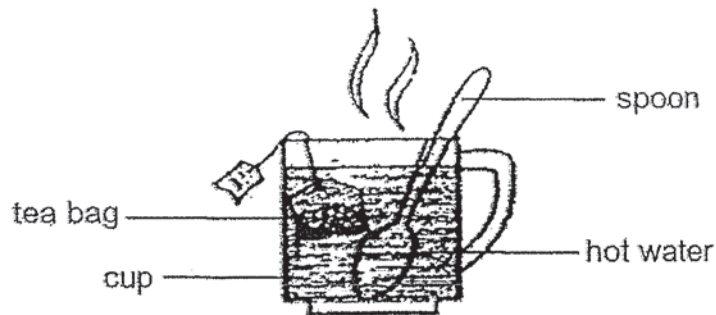

Put a tick (✓) in the appropriate box to show heat gain and/or heat lost during the first 2 minutes. [2]

	Heat gain	Heat lost
tea bag		
hot water		
spoon		
cup		

30. Look at the diagram below.

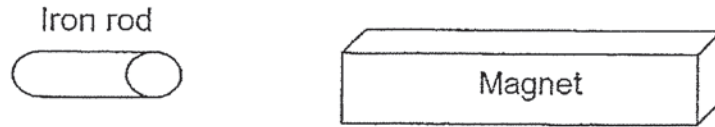

Parvati places a magnet near an iron rod. The iron rod moves towards the magnet.

a) The magnet exerts a \_\_\_\_\_ on the iron rod. [1]

b) Choose the correct word from the box to answer the question below. [1]

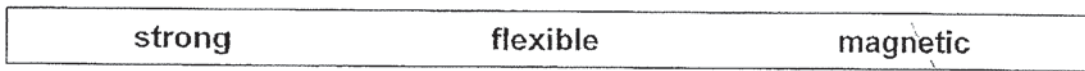

Parvati's observation shows that iron is a \_\_\_\_\_ material.

31a. The diagram below shows the stages in the life cycle of a mosquito.

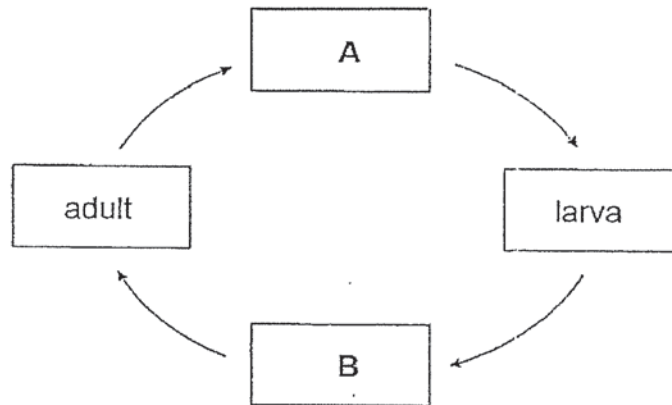

Choose the correct words from the box to answer the question below.

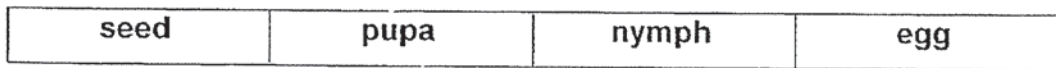

Name the two stages A and B. [2]

A : \_\_\_\_\_

B : \_\_\_\_\_

B - 2

(Go on to the next page)

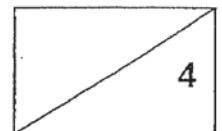

31b. Ajay wants to find out whether light is necessary for a seed to develop into a young plant. He placed four similar pots, W, X, Y and Z, in 4 different locations. Each pot contains 3 seeds and the same amount of soil as shown in the diagram below.

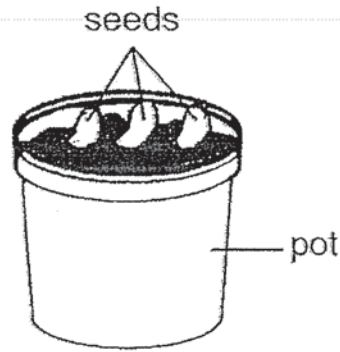

Study the table below.

Pot	Location of seeds in Science Room	Soil
W	in the metal cupboard	dry
X	in the metal cupboard	wet
Y	in the refrigerator	wet
Z	near the open window	wet

- (i) Which two of the pots shown above should Ajay use in his experiment to fulfill his aim and ensure a fair test? Explain your answer. [2]

---



---

- (ii) If Ajay wants to find out whether the amount of water affects the growth of seeds, which two pots should he use in his experiment? [1]

---

32. The diagram below shows the human digestive system.

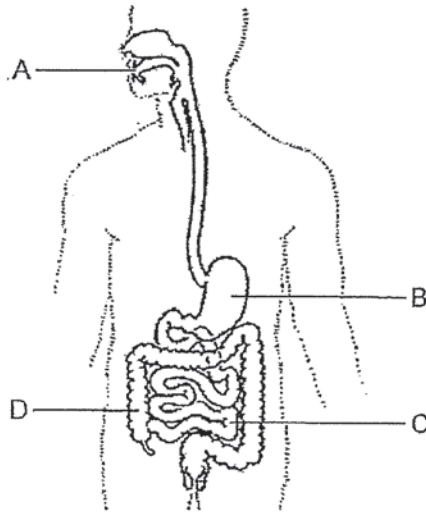

Fill in the blanks with the correct letter, A, B, C or D for Questions (a) to (c).

- a) Digestion first takes place at \_\_\_\_\_ [1]
- b) There is no digestion at \_\_\_\_\_ [1]
- c) Digested food is absorbed into the blood at \_\_\_\_\_ [1]
- d) \_\_\_\_\_ is removed from the undigested food at D. [1]

33. Look at the pictures. Tick (✓) on the source(s) of light.  
Put a cross (✗) for those that are not source(s) of light. [2]

The Sun



eyes



water

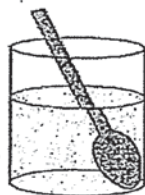



lighted matchstick

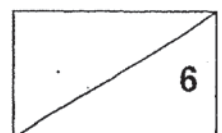

B - 4

(Go on to the next page)



34. Kim Seng placed four similar pieces of bread in four identical sealed boxes, E, F, G and H. Substance A absorbs water from the surroundings.

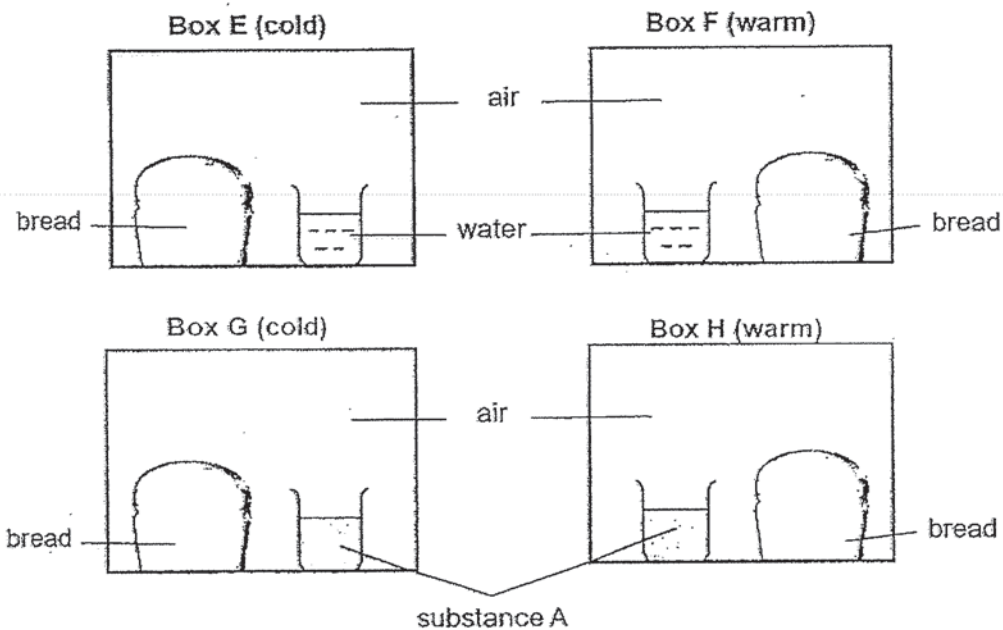

- a) In which box, E, F, G or H, would fungus first appear on the bread? Give a reason for your answer. [2]

---



---

- b) Kristen and Lily had similar leather purses. Both purses became equally wet due to heavy rain. Kristen kept her purse in her closet but Lily put her purse under the Sun for 5 hours before keeping it in her closet.

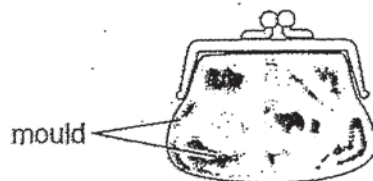

- A month later, mould was found on Kristen's purse but not on Lily's purse. Explain why Lily did not find mould on her purse. [2]

---



---

35. Rebecca wanted to find out the relationship between the number of stones in a bowl and how much the bowl would sink when it was put in water. She placed a different number of similar stones in two identical bowls, S and T.

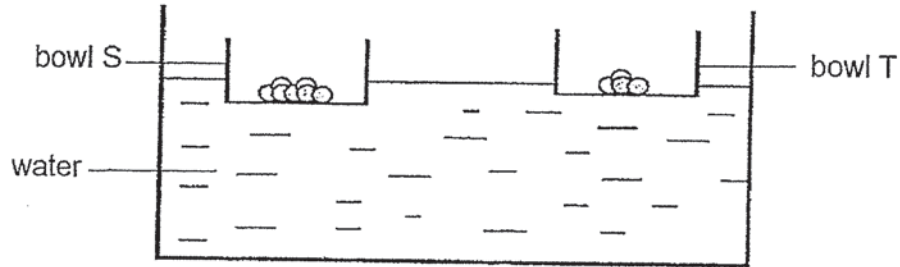

- a) Based on the results shown in the diagram above, what is the relationship between the number of stones and how much the bowl would sink? [1]

---



---

- b) A ship carrying a full load of fish was stuck on the seabed as shown below.

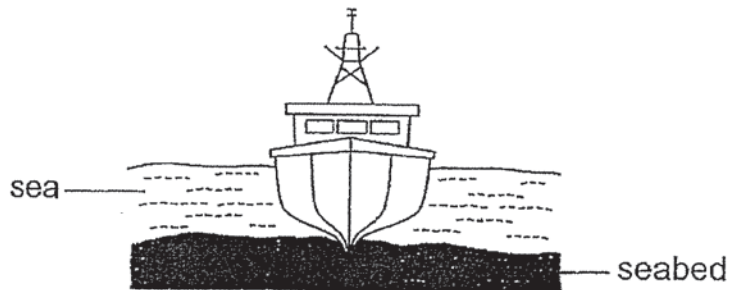

The fishermen threw away some of their fish so that the ship could be lifted off the seabed and moved forward.

- Based on your answer in (a), why did the ship manage to lift off the seabed and moved forward after throwing some fish away? [1]

---



---

36a. Ah Lian wants to conduct an experiment to find out which material, J or K, is better at keeping water warm. She has a flask of hot water at 100°C and the following apparatus as shown below.

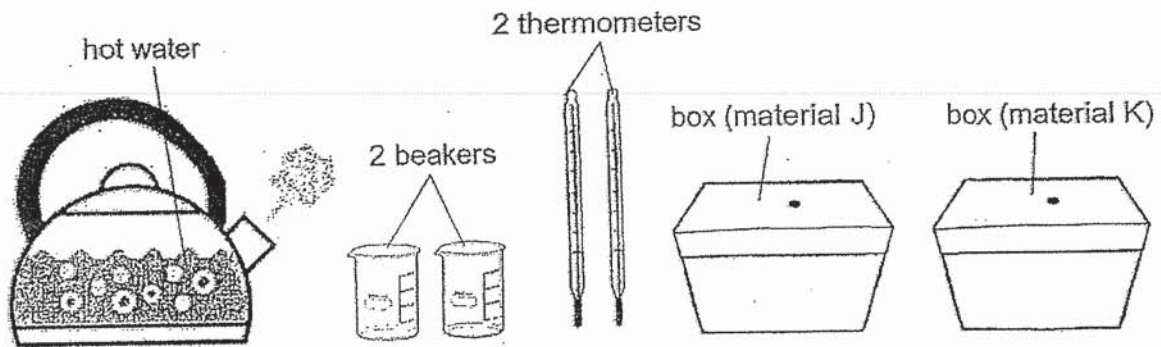

Using the numbers, 1 to 4, put the steps in the correct order for Ah Lian to conduct the experiment. [2]

Description of step	Step
Repeat the experiment 3 times.	
Place a thermometer into each beaker of water. Then, place one beaker of hot water in each of the boxes made of material J and K.	
Fill 2 identical beakers with hot water at 100°C.	
Record the reading on the thermometers every 5 minutes without taking out the thermometers.	



36b. Study the set-up shown below.

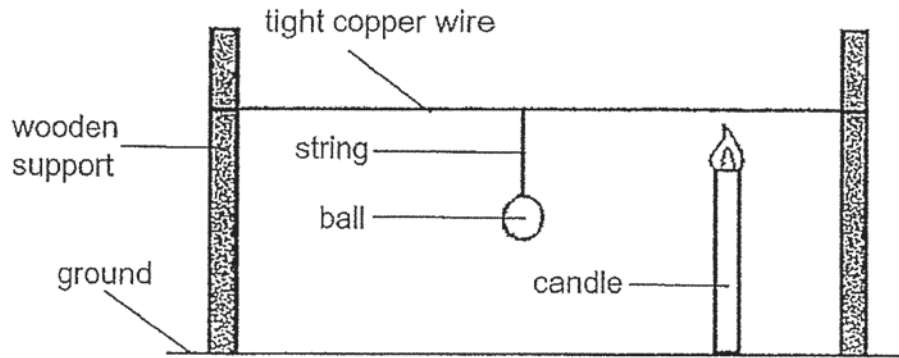

(i) What will happen to the ball when the wire is heated over some time?

Tick (✓) the correct observation.

[1]

Observations of the ball	Tick (✓) correct observation
Move nearer to the ground	
Remains in the same position	
Move further away from the ground	

(ii) Based on the answer in (i), explain your answer.

[1]

---



---

37. Study the diagram below.

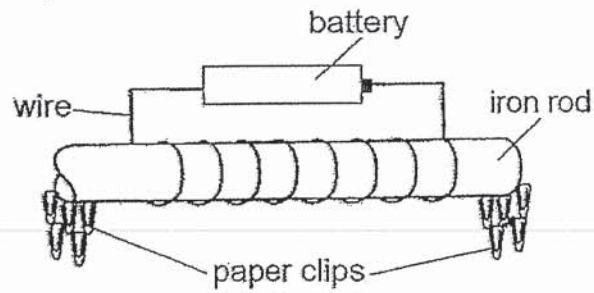

a) What will happen to the paper clips if the battery is removed? [1]

---

---

b) Explain your reason in (a). [1]

---

---

c) Suggest two ways to make the iron rod attract more paper clips. [2]

38a. One dark night, Aishah jogged from point S to point T as shown in the diagram below.

There were 4 street lamps, A, B, C and D, along the street but **only one** lamp was working.

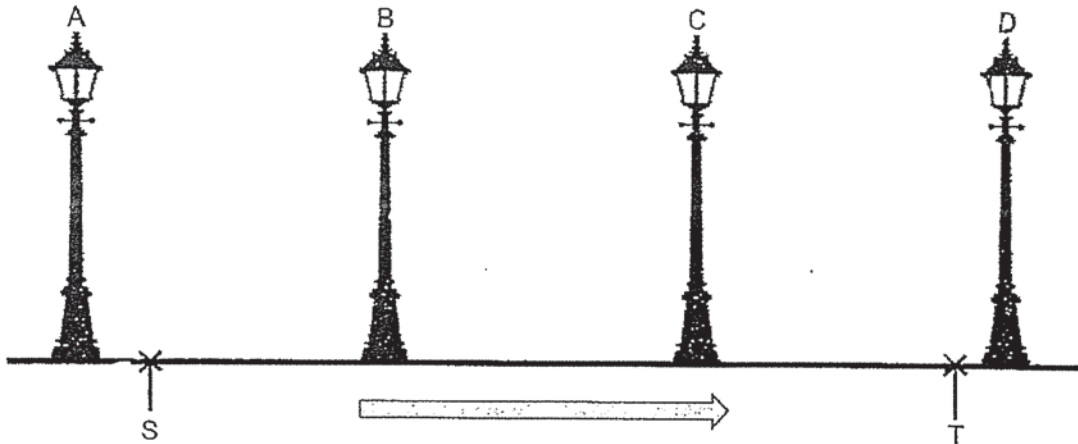

The graph below shows how the length of Aishah's shadow changed as she jogged from point S to point T.

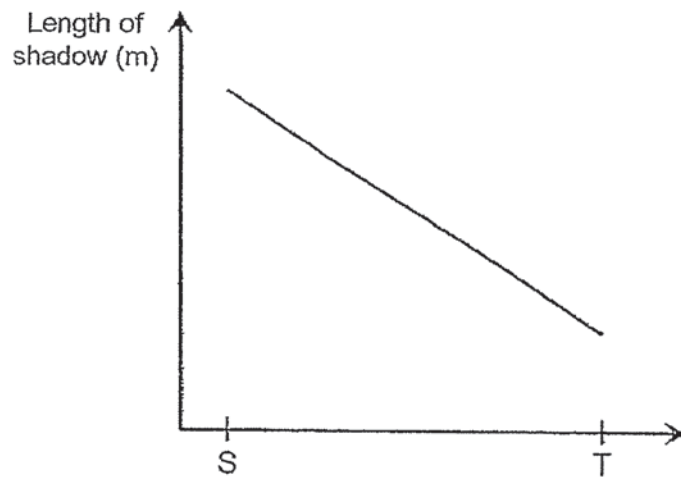

Based on the graph above, which one of the lamps, A, B, C or D, was lighting up the street?

**Circle** your answer.

[1]

A	B	C	D
---	---	---	---

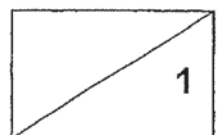

38b. The diagram below shows a lighthouse on a rock. It was night-time and there was no other light sources nearby where boats, D and G, were anchored.

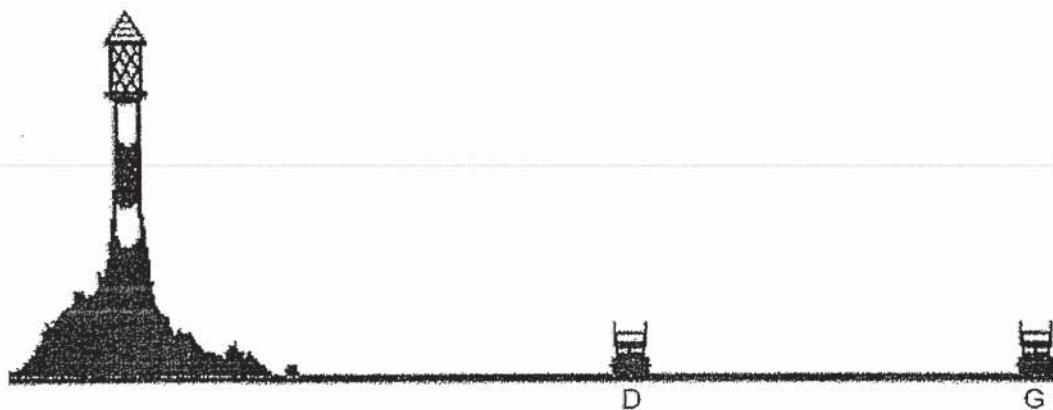

(i) Which boat, D or G, has a longer shadow? [1]

---

(ii) The table below shows how much light Paints A, B and C can reflect when the same light was shone on them.

Amount of light reflected (Units)		
A	B	C
10	80	35

Which paint should be used to paint the boats to avoid collision and accidents ? Explain your answer. [2]

---



---

39a. An experiment is carried out to find out which type of material is the strongest as shown in the diagram below.

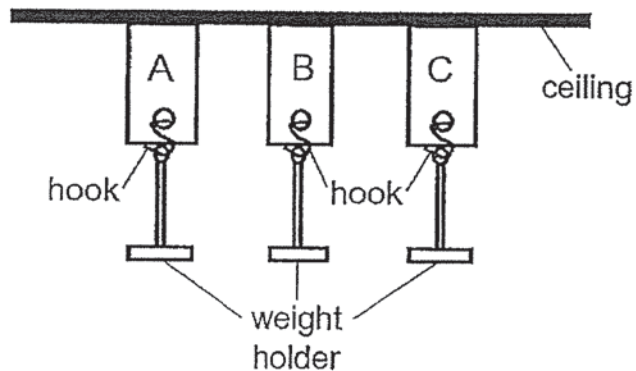

The table below shows the mass of the load till the material breaks.

Material	Mass of load till the material breaks
A	400g
B	200g
C	300g

Tick (✓) the variable/s which must be kept the same/constant for the above experiment. [2]

	Variable	Must be kept constant (✓)
(i)	Type of material	
(ii)	Size of material	
(iii)	Colour of the material	
(iv)	Thickness of the material	

39b. Which material is most suitable for making bag to hold canned food? [1]

\_\_\_\_\_

40. The graph shows the amount of food eaten by a butterfly throughout its life cycle after it hatches.

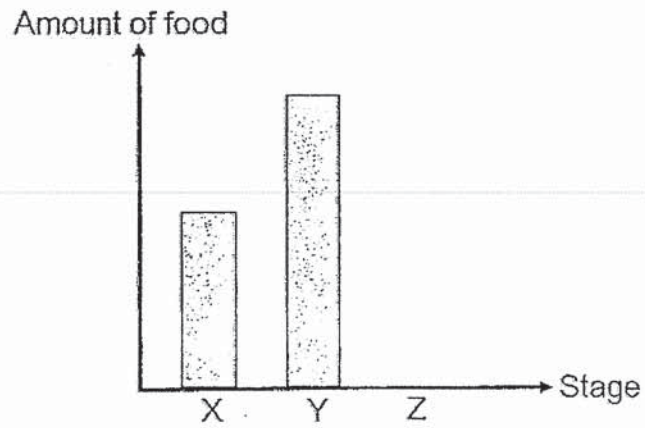

- a) Which part of the graph, X, Y or Z, represents the pupal stage of the butterfly?  
Explain your answer. [2]

---

---

41a. Study the table and fill in the boxes with helping words below.

gas	solid	liquid	non-matter
-----	-------	--------	------------

[2]

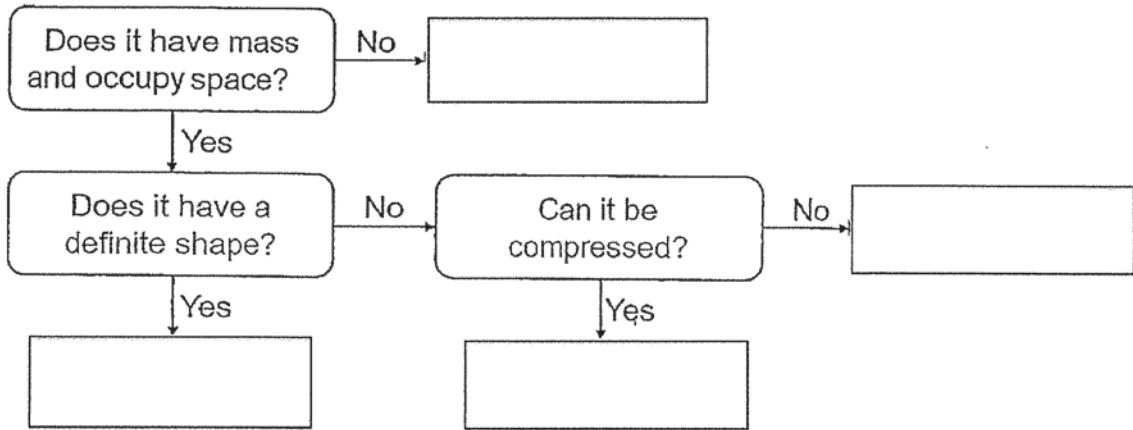

41b. Zack placed a jar of marbles into a basin filled with water. He observed that air bubbles from the jar of marbles rose to the surface.

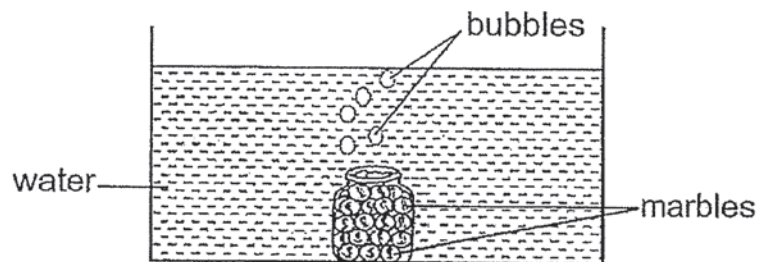

Why did the bubbles appear when the jar of marbles was placed in the basin? [2]

---



---

~ End of Booklet B ~





**SINGAPORE CHINESE GIRLS' SCHOOL  
SECOND SEMESTAL P4 SCIENCE EXAMINATION 2019**

**Part 1 (56m)**

1.	4	6.	3	11.	1	16.	2	21.	2	26.	3
2.	3	7.	1	12.	4	17.	3	22.	2	27.	1
3.	2	8.	4	13.	4	18.	2	23.	2	28.	4
4.	2	9.	3	14.	2	19.	3	24.	3		
5.	4	10.	1	15.	3	20.	4	25.	2		

**Part 2 (44m)**

S/N	Recommended Answers				
29	a) bad / poor		b) good		
29c		Heat gain		Heat lost	
	tea bag	✓			
	hot water			✓	
	spoon	✓			
	cup	✓			
30a	pull / force/ magnetic force				
30b	magnetic				
31a	A: egg		B: pupa		
31bi	a) X and Z b) The <b>variables</b> in both set-ups X& Y are kept the same, except the amount of <b>light/ sunlight</b> they are exposed to OR X and Z are <b>both warmth and have wet soil</b> , but they have <b>different amounts of light</b> .				
31bii	W and X				
32	a) A		b) D		c) C    d) Water
33		✓	The Sun	x	eyes
		x	water	✓	matchstick
3	ox F. Fungus needs <b>warmth and moisture/water</b> to grow well. <i>Vote – pupil needs to specify which of the factors affecting growth of fungi are what F has that the other boxes may lack)</i>				
34b	Putting purse under the Sun helps <b>remove water / moisture</b> from it. <b>Without moisture/water, mould will not be able to grow</b> on Lily's purse.				
35a	The <b>more stones</b> there are, the <b>more/ lower</b> the bowl would sink.				
35b	When the fish is removed, the ship will be <b>lighter</b> and the <b>ship would float up more/ rise higher/ sink less into seabed</b> .				
36a	4   2   1   3				
36bi		Observations of the ball		Tick (✓) correct observation	
		Move nearer to the ground		✓	
		Remains in the same position			
		Move further away from the ground			
36bii	The <b>copper wire gains heat, expands and becomes longer</b> .				

SINGAPORE CHINESE GIRLS' SCHOOL  
SECOND SEMESTAL P4 SCIENCE EXAMINATION 2019

S/N	Recommended Answers															
37a	The paper clips will drop / fall off.															
37b	The iron rod loses its magnetism/ is no longer a magnet when the battery is removed.															
37c	Any 2 of the following: <ul style="list-style-type: none"> <li>- Add / use more batteries.</li> <li>- Make more turns / coiling/ coils of the wire <u>around the rod</u>.</li> <li>- Use batteries of higher voltage.</li> </ul>															
38a	D (Note that the light is cast from above)															
38bi	G (Note that the light is cast from above)															
38bii	B The ship can be seen by other ships most easily. OR The ship can reflect the most light.															
39a	<table border="1" style="width: 100%; border-collapse: collapse;"> <thead> <tr> <th></th> <th>Variable</th> <th>Must be kept constant (✓)</th> </tr> </thead> <tbody> <tr> <td>(i)</td> <td>Type of material</td> <td></td> </tr> <tr> <td>(ii)</td> <td>Size of material</td> <td style="text-align: center;">✓</td> </tr> <tr> <td>(iii)</td> <td>Colour of the material</td> <td></td> </tr> <tr> <td>(iv)</td> <td>Thickness of the material</td> <td style="text-align: center;">✓</td> </tr> </tbody> </table>		Variable	Must be kept constant (✓)	(i)	Type of material		(ii)	Size of material	✓	(iii)	Colour of the material		(iv)	Thickness of the material	✓
	Variable	Must be kept constant (✓)														
(i)	Type of material															
(ii)	Size of material	✓														
(iii)	Colour of the material															
(iv)	Thickness of the material	✓														
39b	A															
40a	Z. At the pupal stage, the pupa will not eat any food.															
41a	<div style="text-align: center;"> <pre> graph TD     Q1{Does it have mass and occupy space?} -- No --&gt; NM[Non-matter]     Q1 -- Yes --&gt; Q2{Does it have a definite shape?}     Q2 -- No --&gt; Q3{Can it be compressed?}     Q2 -- Yes --&gt; S[Solid]     Q3 -- No --&gt; L[Liquid]     Q3 -- Yes --&gt; G[Gas]           </pre> </div>															
41b	There was <u>air trapped among the marbles</u> in the jar / There were <u>air spaces among the marbles</u> in the jar. <u>Water from the basin took up/ occupied the space previously occupied by these air spaces/ displaced the air</u> and <u>air escaped</u> as the bubbles that appeared.															

2  
BWP.