



NANYANG PRIMARY SCHOOL
PRIMARY 4 SCIENCE
SEMESTRAL ASSESSMENT 2
2019

BOOKLET A

Date : 22 October 2019
Duration : 1 h 45 min

Name : _____ ()

Class: Primary 4 ()

**DO NOT OPEN THIS BOOKLET UNTIL YOU ARE TOLD TO DO SO.
FOLLOW ALL INSTRUCTIONS CAREFULLY.**

Booklet A consists of 18 printed pages including this cover page.

Section A (28 x 2 = 56)

For each question from 1 to 28, four options are given. One of them is the correct answer. Indicate your choice in this booklet and shade the correct oval (1, 2, 3 or 4) on the Optical Answer Sheet provided.

1. Which one of the following is a non-living thing?

(1)



(2)

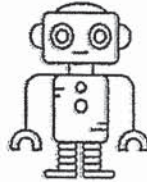

(3)



(4)



2. Study the chart below.

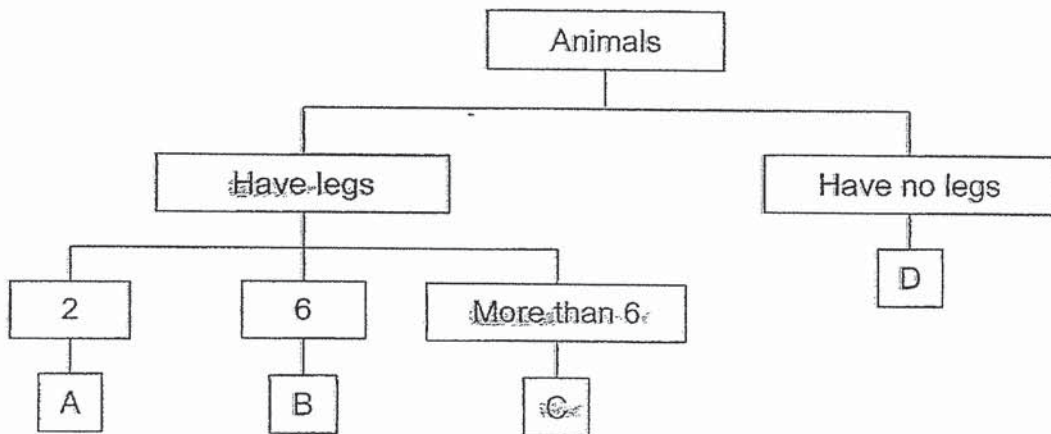

Where would you classify this animal in the chart above?

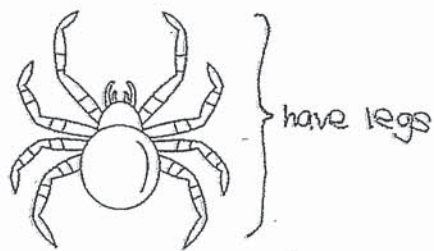

- (1) A
- (2) B
- (3) C
- (4) D

3. The diagram below shows a young plant.

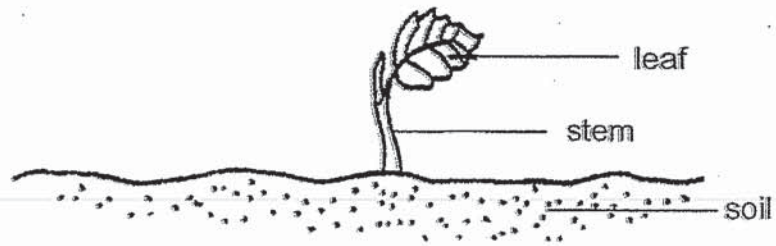

The stem helps the plant to _____.

- (1) make food
 - (2) absorb water
 - (3) support the leaf
 - (4) absorb mineral salts
4. Which organ system is shown in the diagram below?

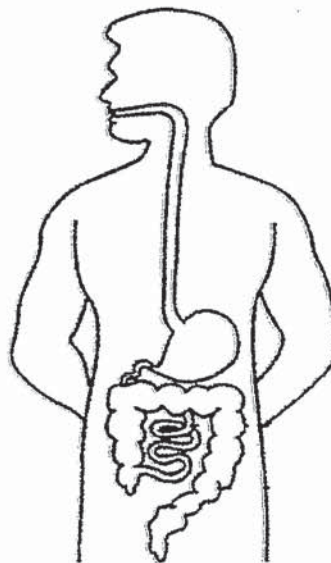

- (1) digestive system
- (2) muscular system
- (3) circulatory system
- (4) respiratory system

5. The diagram below shows the growth of a young plant with two missing stages, X and Y.



Which one of the following correctly represents stages X and Y?

	X	Y
(1)		
(2)		
(3)		
(4)		

6. In which one of the following set-ups will the two magnets pull towards each other?

(1)

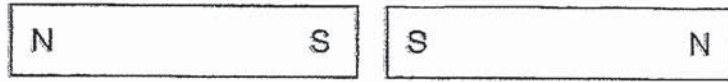

(2)

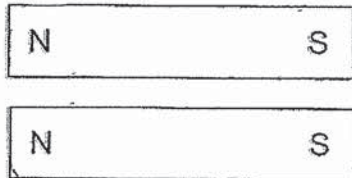

(3)

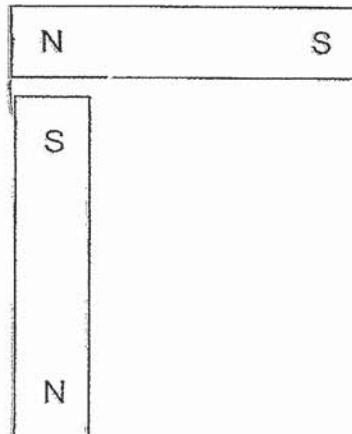

(4)

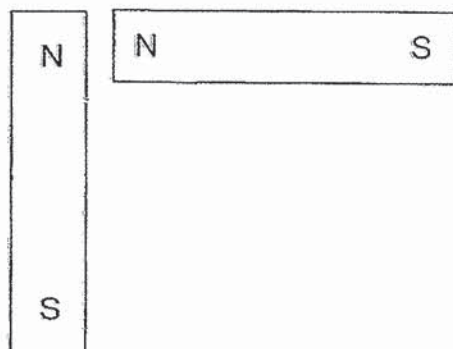

7. The diagram below shows a knife.

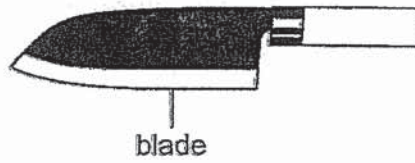

Metal is used to make the blade of the knife because metal _____.

- (1) can reflect light
- (2) does not break easily
- (3) can bend without breaking
- (4) does not allow light to pass through it

8. Study the picture below.

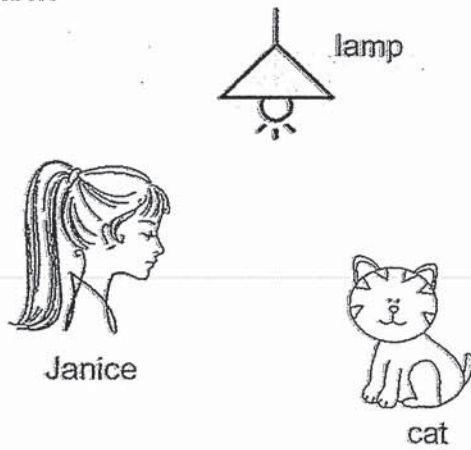

Which one of the following light rays explains why Janice can see the cat on the ground?

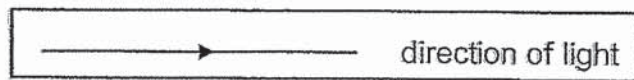

(1)

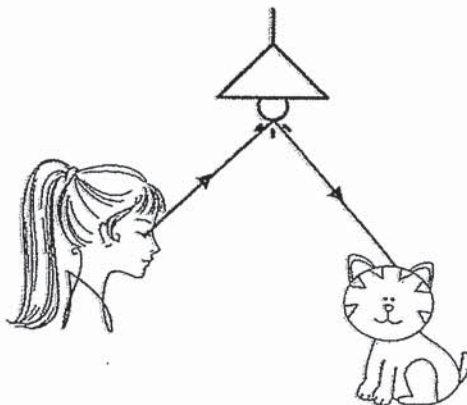

(2)

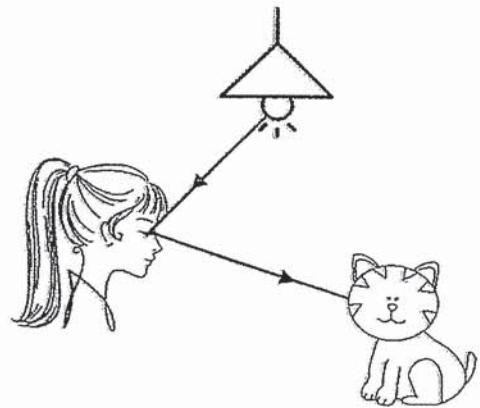

(3)

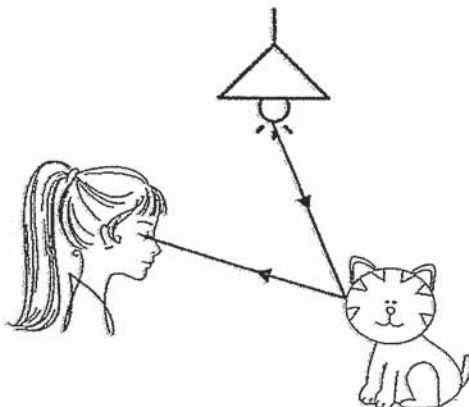

(4)

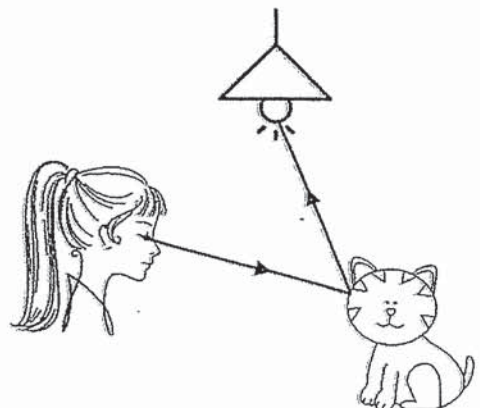

9. Jeremy wants to measure the temperature of cold water in a beaker.

Which one of the following diagrams shows the correct position of the thermometer for him to read the temperature of the water?

(1)

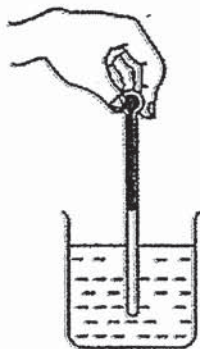

(2)

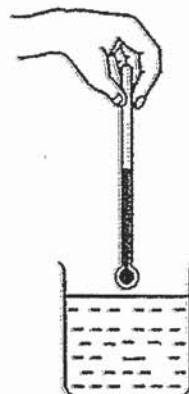

(3)

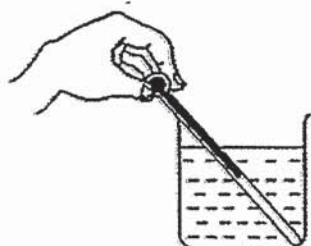

(4)

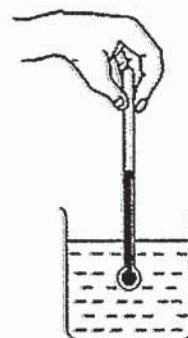

10. Which one of the following properties is **not true** for oil and a table?

- (1) They can be seen.
- (2) They occupy space.
- (3) They have a definite shape.
- (4) They have a definite volume.

11. Study the table below.

Living Things	Non-living Things
bird goldfish chicken	moss stone yeast

Which two of the above had been **wrongly** grouped?

- (1) stone and chicken (2) moss and yeast
(3) bird and stone (4) moss and goldfish

12. The diagram below shows plant S growing in the garden.

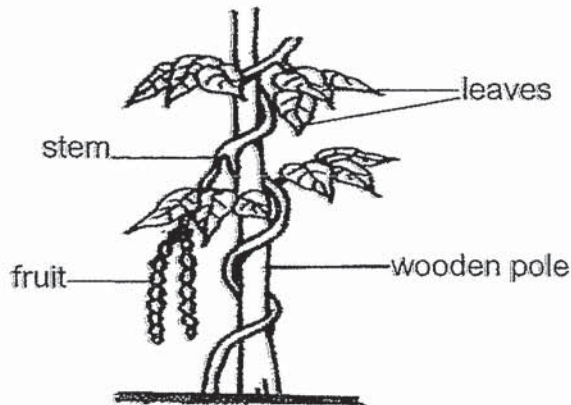

Which of the following statement(s) is/are correct?

- A Plant S has a weak stem.
B Plant S is a flowering plant.
C Plant S is able to make food.

- (1) B only (2) A and B only
(3) A and C only (4) A, B and C

15. Roy wanted to find out if the green leaves of a plant would affect its survival. He removed all the leaves of plant X and left it in the garden. He watered the plant daily.

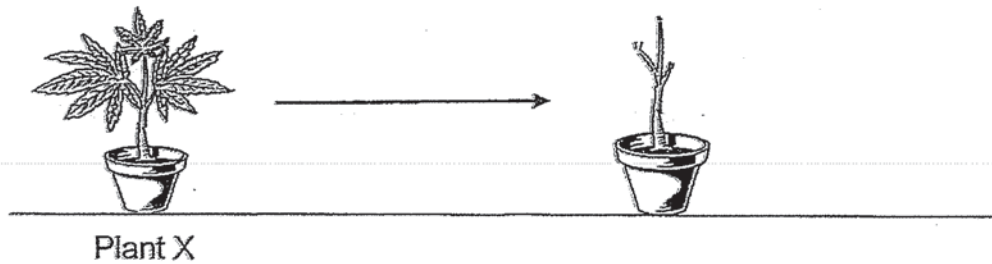

After a week, Roy observed that the plant had stopped growing and died.

Which one of the following reasons best explains why the removal of leaves had caused the above observation?

- (1) Plant X does not have leaves to make food.
 - (2) Plant X does not have leaves to take in water.
 - (3) Plant X does not have leaves to support the plant upright.
 - (4) Plant X does not have leaves to hold the plant firmly to the soil.
16. The diagram below shows the human digestive system.

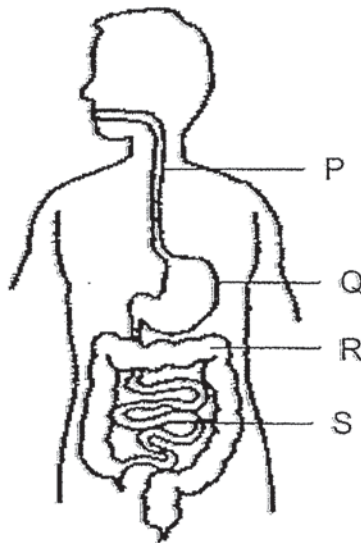

Which of the following statements **incorrectly** describe what happens in parts P, Q, R and S?

- A Food is not digested at P.
 - B No digested food is absorbed at S.
 - C Water is removed from the undigested food at R.
 - D Undigested food is absorbed into the bloodstream at Q.
- (1) A and B only
 - (2) A and C only
 - (3) B and D only
 - (4) C and D only

17. Study the information in the table below.

	Human organ system	Function
A	skeletal system	protects the important organs in the body
B	respiratory system	takes in air for the body only
C	circulatory system	Carries water, oxygen and digested food in the blood to all parts of the body

Which of the above body system(s) correctly matches its function?

- (1) B only
(2) C only
(3) A and B only
(4) A and C only

18. Study the flow chart below.

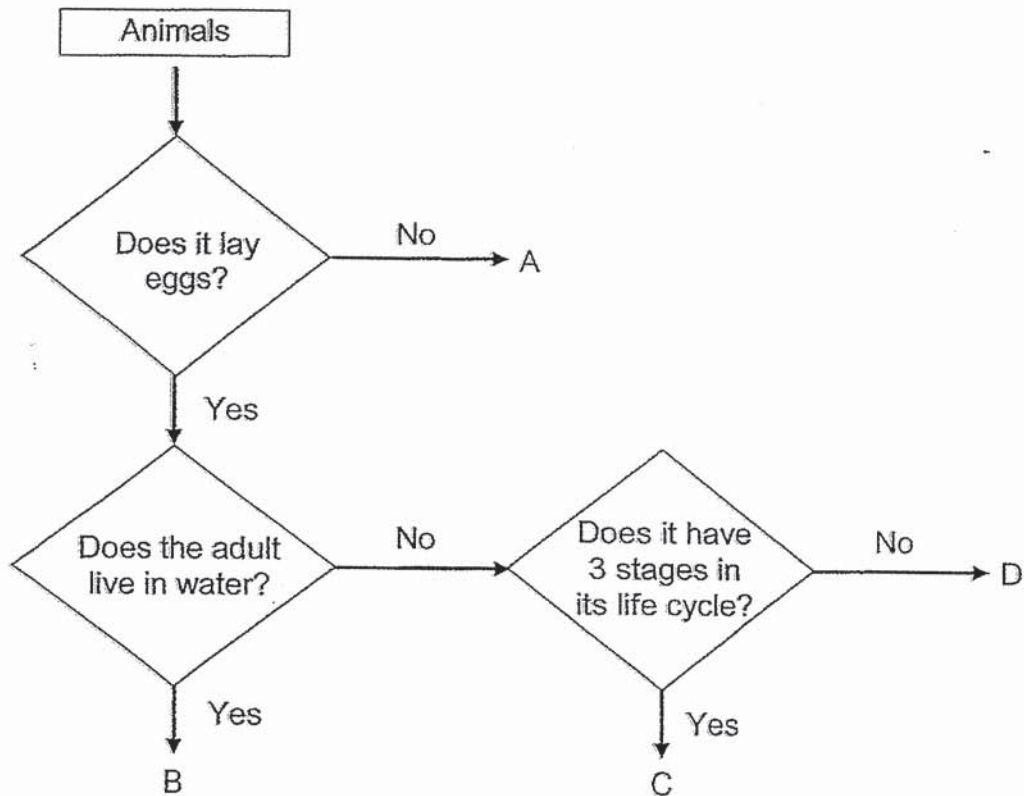

Which one of the following is most likely to be a grasshopper?

- (1) A
(2) B
(3) C
(4) D

19. The diagram below shows the life cycles of a housefly and a bee.

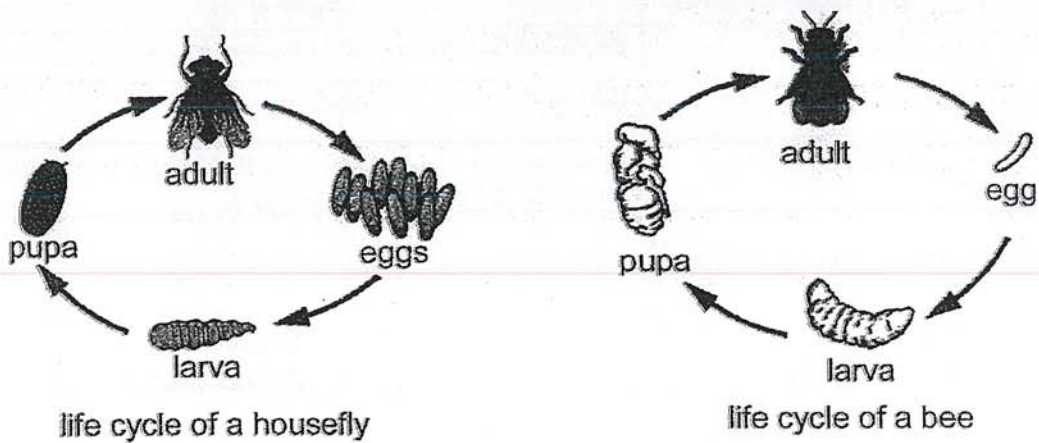

Based only on the diagram above, which of the following statements correctly describe the similarities in the life cycles of a housefly and a bee?

- A The larvae look like the adults.
- B Both life cycles have four stages..
- C Both life cycles have a pupal stage..

- (1) A only
- (2) B only
- (3) B and C only
- (4) A, B and C

20. Study the diagram below. There are two light sources shining on the pole.

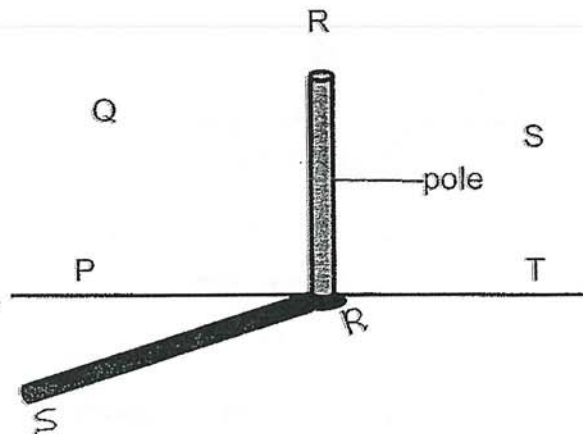

Based on the diagram, which of the following statements are correct?

- A The light sources were at Q and T only.
- B The light sources were at R and S only.
- C The pole is made of a material that allows most light to pass through it.
- D The pole is made of a material that does not allow light to pass through it.

- (1) A and C only
- (2) A and D only
- (3) B and C only
- (4) B and D only

21. Sharis wanted to find out how the distance between an object and the screen affects the shadow formed by the object on the screen. She made her observations and recorded the results in the graph below.

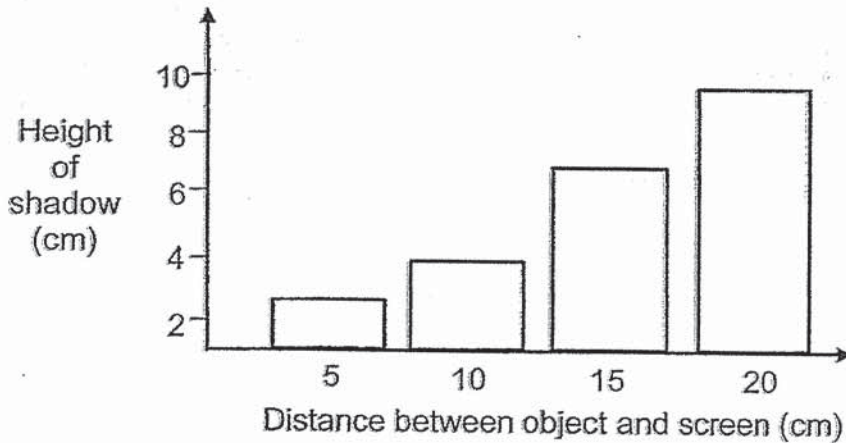

Based on the results above, which of the following correctly describes the relationship between the height of the shadow and the distance between the object and the screen?

	Distance between object and screen	Height of shadow
(1)	Decreases	decreases
(2)	Decreases	remains the same
(3)	Increases	decreases
(4)	Increases	remains the same

22. Samuel placed some ice cubes in a clear plastic box on a table as shown in the diagram below. He observed that the ice cubes started to melt after a while.

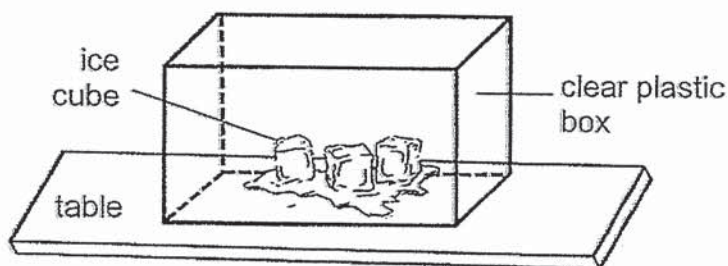

Based on the diagram above, which one of the following statements is correct?

- (1) The clear plastic box gained heat from the ice cubes and the table.
- (2) The table gained heat from the clear plastic box and the ice cubes.
- (3) The ice cubes gained heat from the table and the clear plastic box.
- (4) The ice cubes gained heat from the table but lost heat to the clear plastic box.

23. The diagram below shows two experimental set-ups. The beakers of water are heated over a Bunsen burner until the water in each beaker reached 100°C.

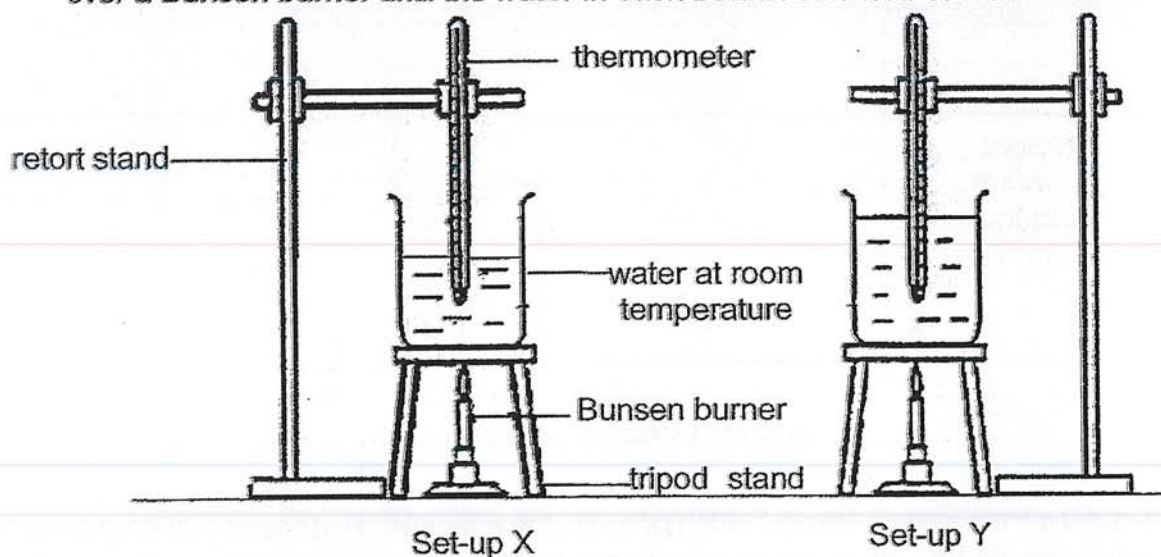

Which one of the following statements is true?

- (1) The water in both set-ups have the same amount of heat energy
 - (2) The water in set-up Y has less heat energy than the water in set-up X.
 - (3) The water in set-up Y has more amount of heat energy than the water in set-up X.
 - (4) The water in both set-ups will reach room temperature at the same time after the heat source is removed.
24. Jun Xiong poured 30 cm³ of water into a container filled with 20 cm³ of sand. Bubbles were seen coming out from the sand as shown in the diagram below. After all the water was poured into the container, he observed that the water level was at the 40-cm³ mark.

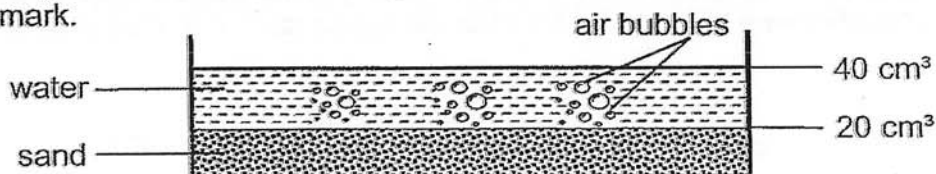

Which one of the following statements best explains Jun Xiong's observation?

- (1) The sand has no definite volume.
- (2) The sand absorbed the water in the container.
- (3) The water in the container was compressed by the sand.
- (4) The water took up the space that was previously occupied by the air in the sand.

25. Study the classification table below.

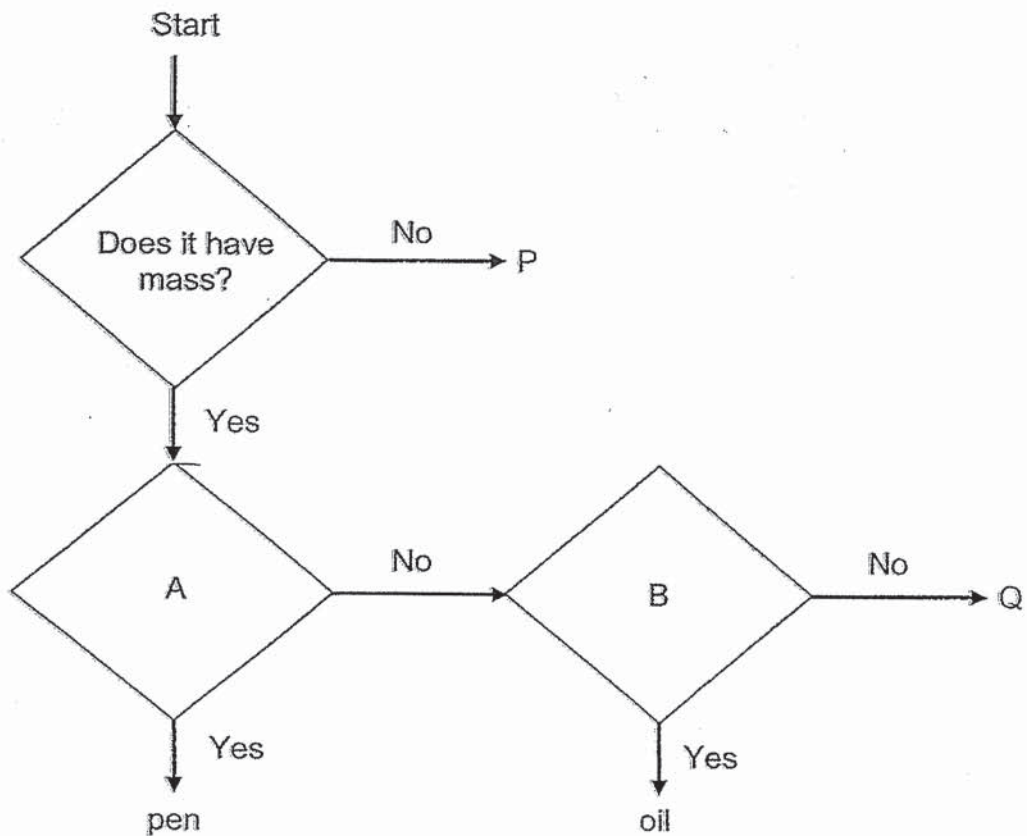

Which one of the following best represents questions A and B, and examples, P and Q in the classification table?

	A	B	P	Q
(1)	Can it be compressed?	Does it have a definite shape?	light	water
(2)	Does it have a definite shape?	Does it have a definite volume?	light	air
(3)	Does it have a definite volume?	Can it be compressed?	heat	air
(4)	Does it have a definite shape?	Can it be compressed?	heat	water

26. Study the flow chart below.

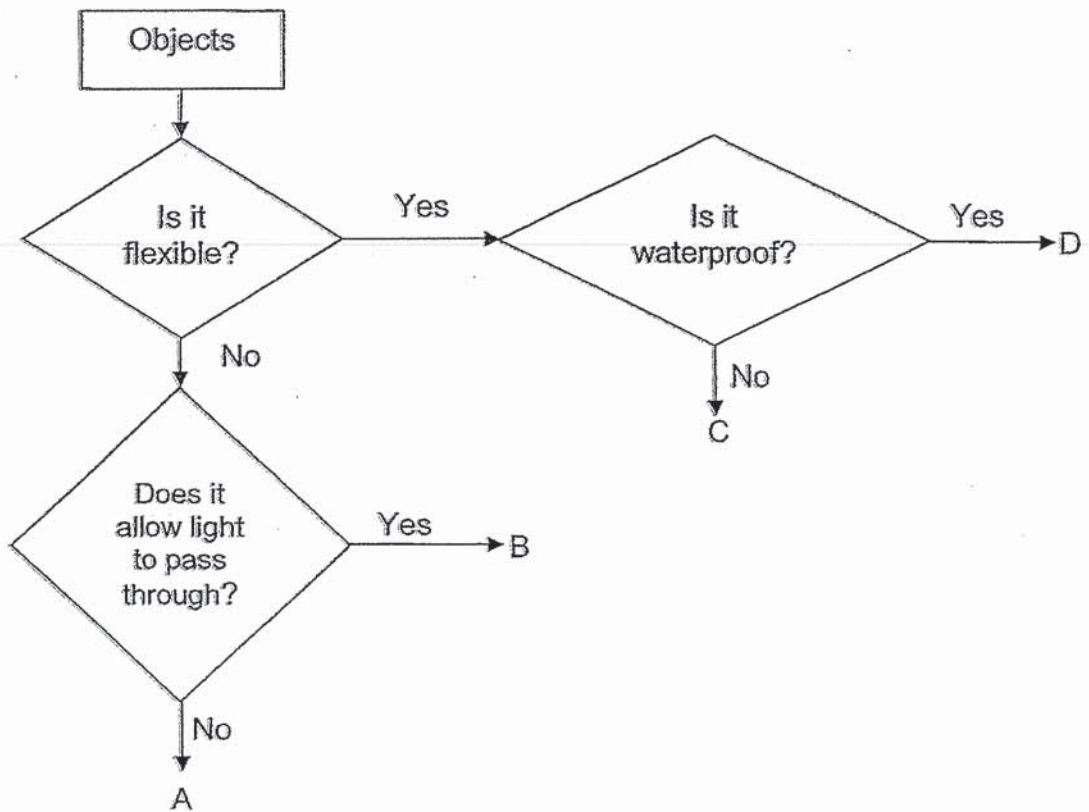

Which one of the following best represents objects A, B, C and D?

	A	B	C	D
(1)	metal pipe	rubber boot	glass beaker	wooden plate
(2)	cotton shirt	metal pipe	plastic bag	glass beaker
(3)	wooden plate	glass beaker	cotton shirt	plastic bag
(4)	plastic bag	glass beaker	wooden plate	cotton shirt

27. An iron block was placed on the plastic toy truck as shown in the diagram below. A magnet was then positioned near the back of the toy truck. It was observed that the toy truck moved towards the magnet as indicated by the arrow.

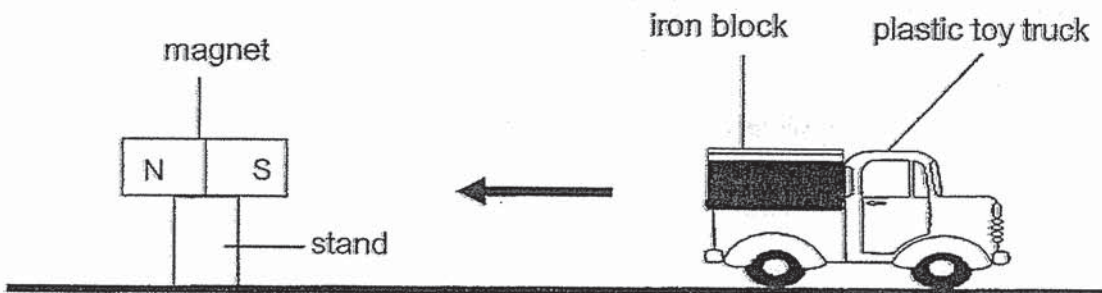

Which of the following would enable the plastic toy truck to take a shorter time to reach the magnet?

- A Change the magnet to a stronger magnet
- B Flip the magnet such that the north pole is facing the truck.
- C Replace the iron block with a copper block of the same mass.

- (1) A only
- (2) B only
- (3) A and C only
- (4) B and C only

28. The diagram below shows a bar magnet and a nail that has not been magnetised. The North-pole of the bar magnet can attract the nail as shown below.

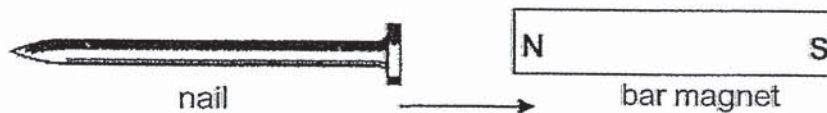

Based on the observation above, which one of the following statements is most likely true?

- (1) The nail is a magnet.
- (2) The nail is made of aluminium.
- (3) The South-pole of the bar magnet can repel the nail.
- (4) The South-pole of the bar magnet can attract the nail.

~ END OF BOOKLET A ~

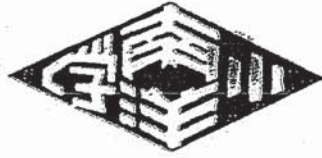

NANYANG PRIMARY SCHOOL

PRIMARY 4 SCIENCE

SEMESTRAL ASSESSMENT 2
2019

BOOKLET B

Date : 22 October 2019

Duration : 1 h 45 min

Name : _____ (.)

Class: Primary 4 ()

Marks Scored:

Booklet A:		56
Booklet B :		44
Total :		100

Any query on marks awarded should be raised by 1 November 2019 . We seek your understanding in this matter as any delay in the confirmation of marks will lead to delays in the generation of results.

Parent's signature:

DO NOT OPEN THIS BOOKLET UNTIL YOU ARE TOLD TO DO SO.
FOLLOW ALL INSTRUCTIONS CAREFULLY.

Booklet B consists of 15 printed pages including this cover page.

Section B

Write your answers to questions 29 to 41 in the spaces provided.

29. Fill in the correct plant parts based on the function given in the table. [2]

Functions of plant parts	Plant parts
(i) It makes food for the plant.	
(ii) It holds the plant firmly to the ground.	

30. Andrew placed a magnet near a steel rod as shown below.

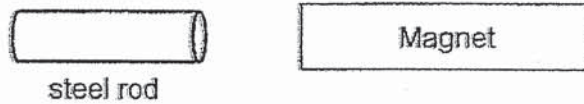

He observed that the steel rod moves towards the magnet.

(a) The magnet exerts a _____ on the steel rod. [1]

(b) Choose the correct word from the box to complete the sentence below. [1]

flexible	magnetic	waterproof
----------	----------	------------

Andrew's observation shows that steel is a _____ material.

31. Look at the pictures below. Tick (✓) the light sources.

[2]

lit candle



moon



eyes



sun

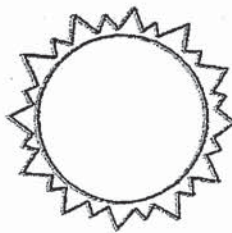

32. Randall placed a metal rod and a wooden rod into a basin of boiling water as shown below. He then placed equal amounts of wax on both rods.

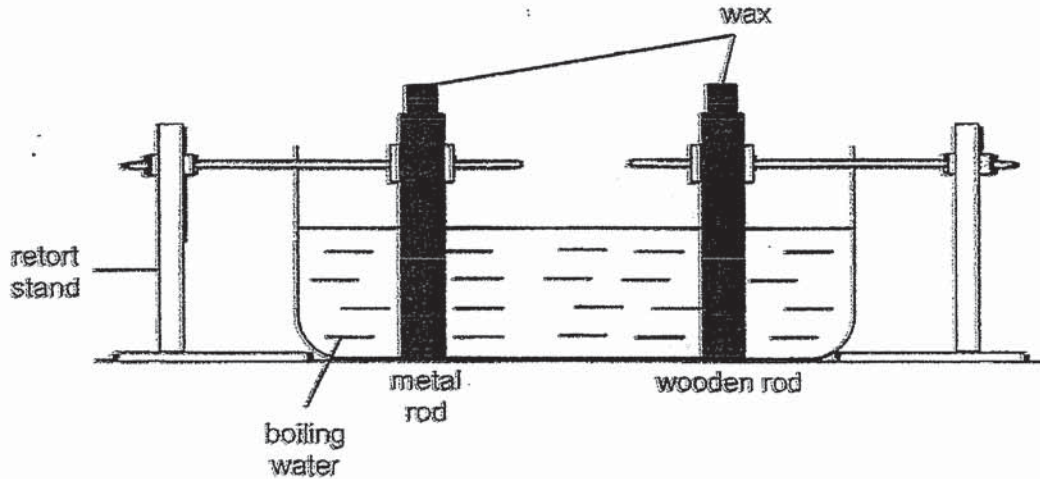

Fill in the blanks to describe what Randall would observe and the reason why. [2]

The wax on the metal rod melted _____ than the wax on the wooden

rod as metal is a _____ conductor of heat than wood.

33. Charmaine compares the mass of 3 identical blocks, X, Y and Z, made of different materials.

She made the following observations.

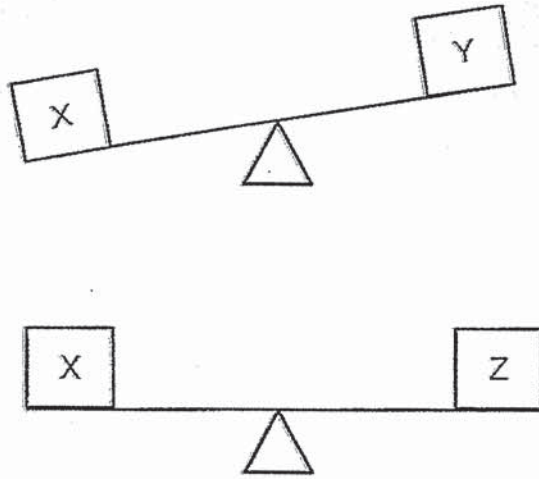

Based on her observations, circle the correct comparison for parts (a) and (b).

- (a) Block X is **heavier than** / **'has the same mass as'** / **'is lighter than'** block Y. [1]
- (b) Block X **'is heavier than'** / **'has the same mass as'** / **'is lighter than'** block Z. [1]

34. Study the two plants below carefully.

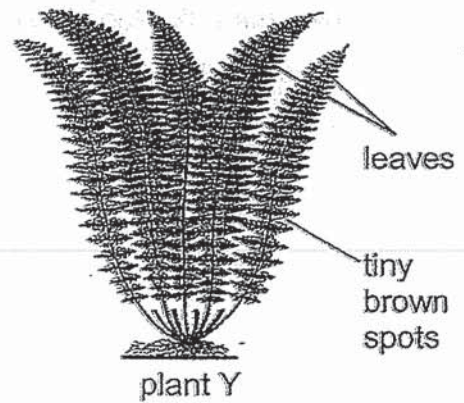
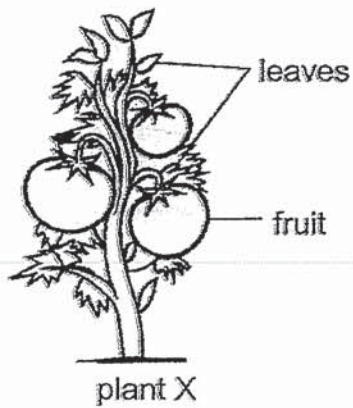

(a) State one difference between the two plants in terms of how they reproduce. [1]

(b) Plant X has a strong stem. How does the strong stem help plant X to grow better? [1]

(c) Classify plant X and plant Y into the table below. [1]

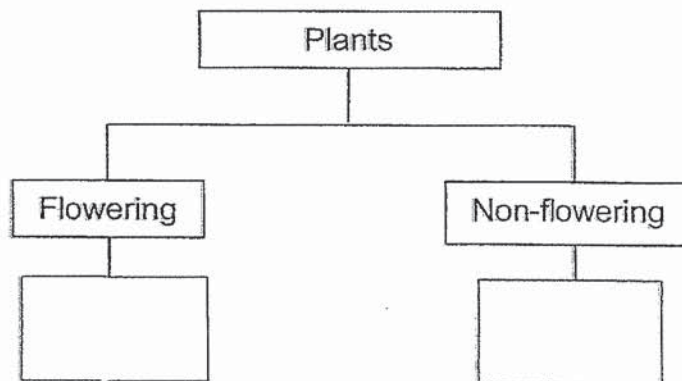

(d) State an example of a non-flowering plant. [1]

35. Study the classification chart below.

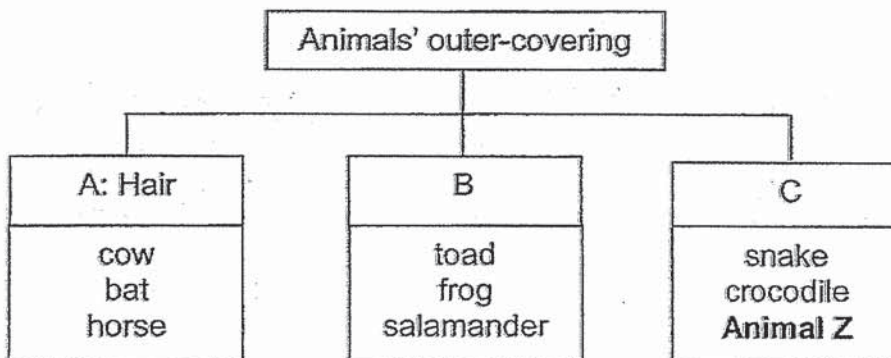

(a) State the type of the outer-covering that correctly represents B and C. [1]

(i) B: _____

(ii) C: _____

(b)(i) State the main function of hair for the animals in group A. [1]

(b)(ii) State another characteristic of the animals in group A. [1]

(c) The characteristics of Animal Z are shown below.

- It lays eggs
- It has four legs
- It feeds on water plants
- It breathes through its lungs

Name the **animal group** that animal Z belongs to. [1]

36. Study the diagram below. Parts A, B and C are organs in the human digestive system.

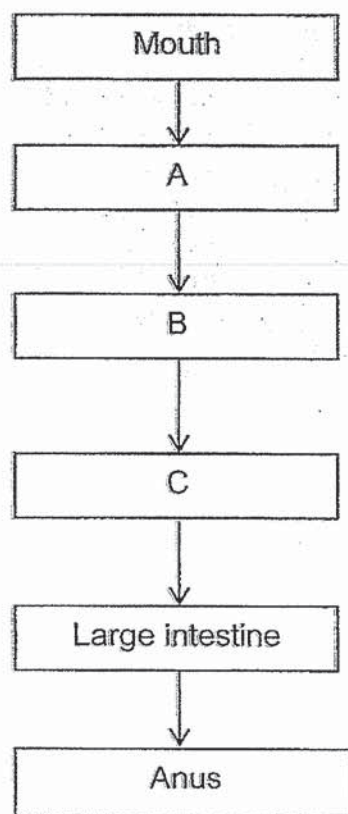

(a) In which organ, A, B or C, will the digested food be absorbed into the bloodstream? [1]

(i) Organ _____

(ii) Identify the organ in (a)(i) : _____

(b) What would happen to the food in organ A and organ B? [2]

(i) Organ A :

(ii) Organ B :

(c) Name all the organs in the digestive system that produce digestive juices. [1]

37. Mrs Lee left a piece of moist bread in a sealed plastic bag on her table. She spotted some 'green patches', P, on the piece of moist bread after a few days as shown in the diagram below.

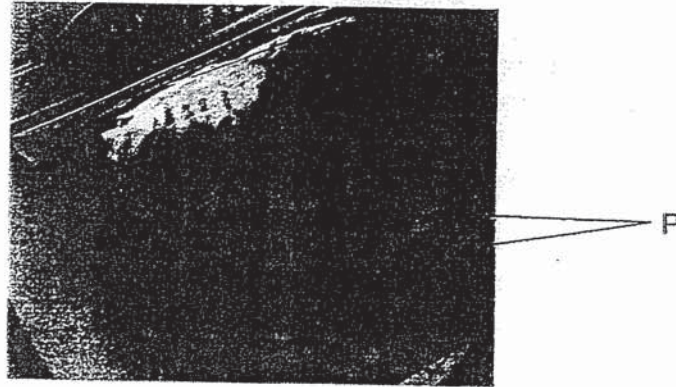

Her son, Ben, said that P are living things that reproduced by spores.

- (a) Which group of living things does P belong to? [1]

Ben said that P cannot make their own food.

- (b) Explain how P get their own food. [1]

(Continue from Question 37)

Ben suffers from a skin condition in which living thing Q grew on his feet. Q belongs to the same group of living things as P.

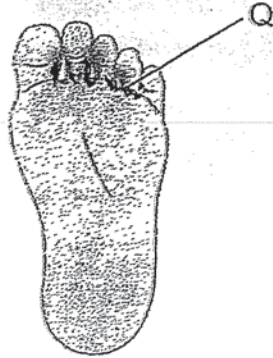

Ben's doctor said that living thing Q grows on his feet because his feet are wet and he wears covered shoes for a long period of time every day.

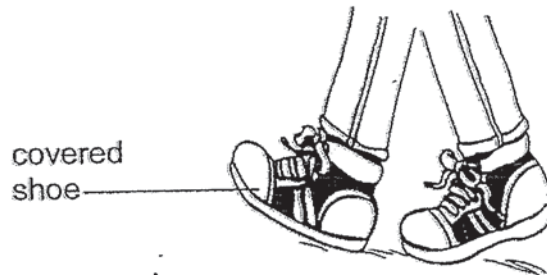

- (c) Which of the conditions below enabled living thing Q to grow on Ben's feet?
Tick (✓) the correct boxes. [2]

warmth	<input type="checkbox"/>
sunlight	<input type="checkbox"/>
water	<input type="checkbox"/>
Wind	<input type="checkbox"/>

38. Study the diagram below that shows the life cycles of a frog and a butterfly.

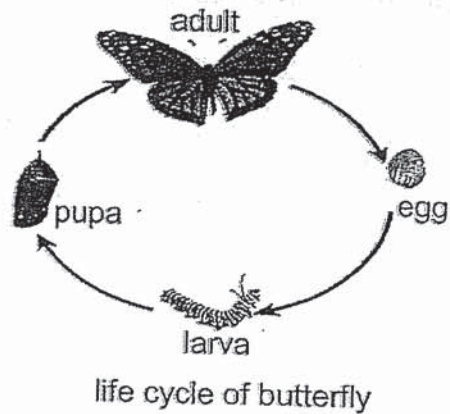
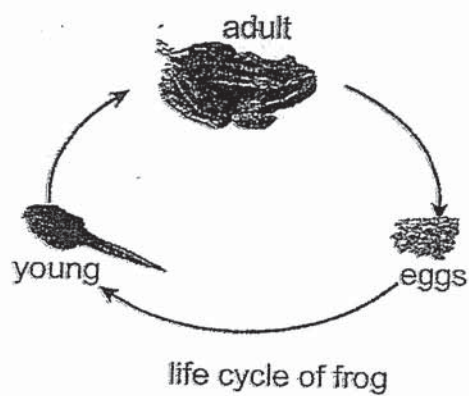

(a) Based only on the above life cycles, state one similarity and one difference between the two life cycles.

(i) Similarity: [1]

(ii) Difference: [1]

(Continue from Question 38)

The diagram below shows the life cycle of a cockroach.

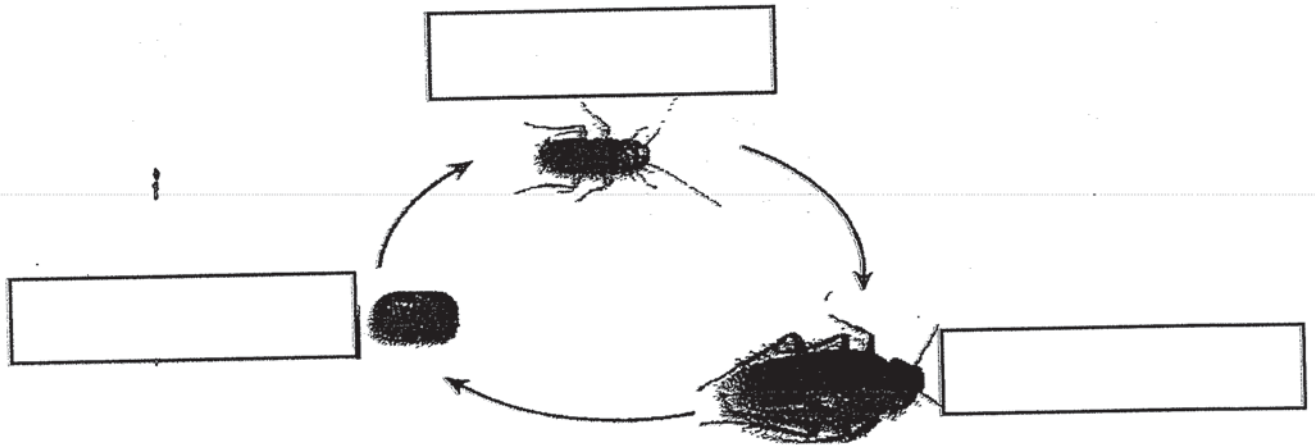

(b)(i) **Label** the stages of the life cycle of a cockroach in the boxes provided above. [1]

(b)(ii) Both the frog and the cockroach have similarities and differences in their life cycles. State one difference between their life cycles. [1]

(b)(iii) The adult cockroach reproduces by laying eggs. Explain why animals reproduce. [1]

39. Sally placed three ring magnets through a wooden pole as shown in the diagram below. She observed that magnet B rested on top of magnet A while magnet C 'floated' on top of magnet B.

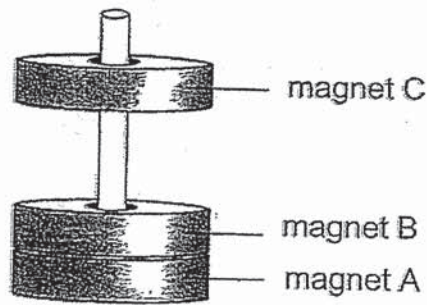

- (a) Explain how magnet C was able to 'float' above magnet B. [2]

- (b) Suggest what Sally could do to make all the three ring magnets attract one another. [1]

- (c) Sally then took ring magnet A and lowered it into a tray of steel paper clips as shown in diagram 1. Diagram 2 shows the bottom view of the ring magnet.

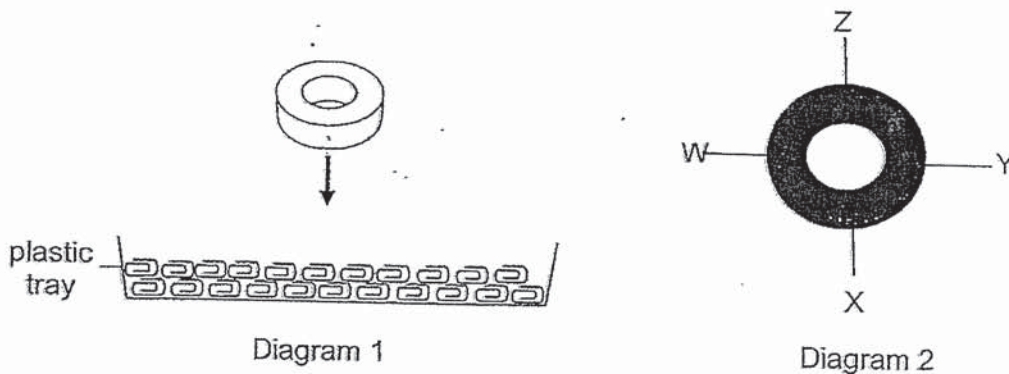

The following table shows the number of paper clips attracted to the bottom of the ring magnet at positions W, X, Y and Z. Complete the table below. [1]

Position W	Position X	Position Y	Position Z
2		2	

40. Muthu wanted to compare the masses of three different objects, K, L and M. He recorded their masses in the table as shown below.

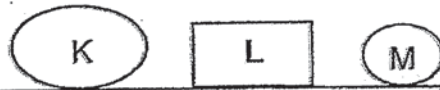

Object	Mass (g)
K	20
L	4
M	67

- (a) Based on the results of the table above, arrange objects K, L and M from the smallest mass to the greatest mass in the space below. [1]

smallest mass $\xrightarrow{\hspace{10em}}$ greatest mass		

Next, Muthu wanted to compare the volumes of two objects, L and M, using the set-up shown below.

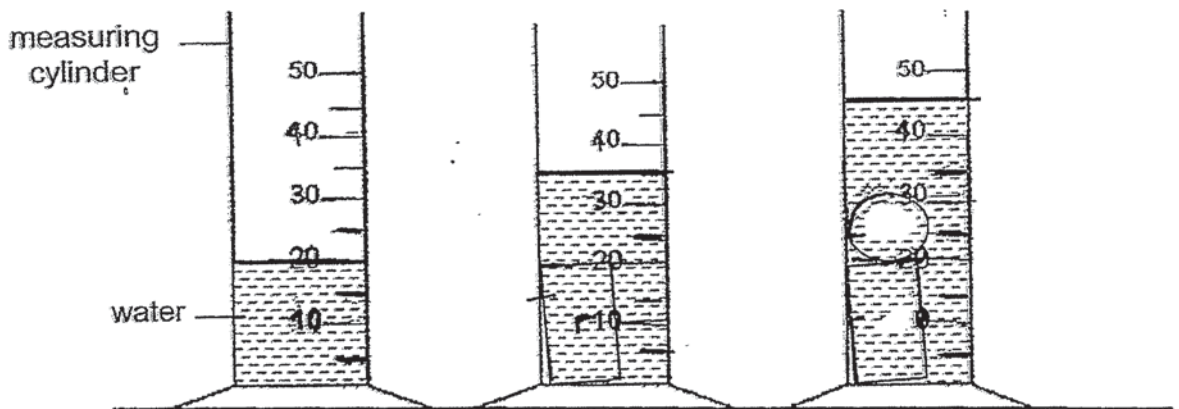

- (b) What were the volumes of objects L and M? [1]

Object L: _____ cm³ Object M: _____ cm³

- (c) State the property of objects L and M shown in the experimental set-up above. [1]

(Continue from Question 40)

Based on the two experiments above, Muthu concluded that the smaller the mass of the object, the smaller the volume of the object.

- (d) Explain why he was wrong when comparing the masses and volumes of objects L and M. [1]

41. Alicia set up an experiment as shown below. She placed flask P in a tub of hot water at 60°C.

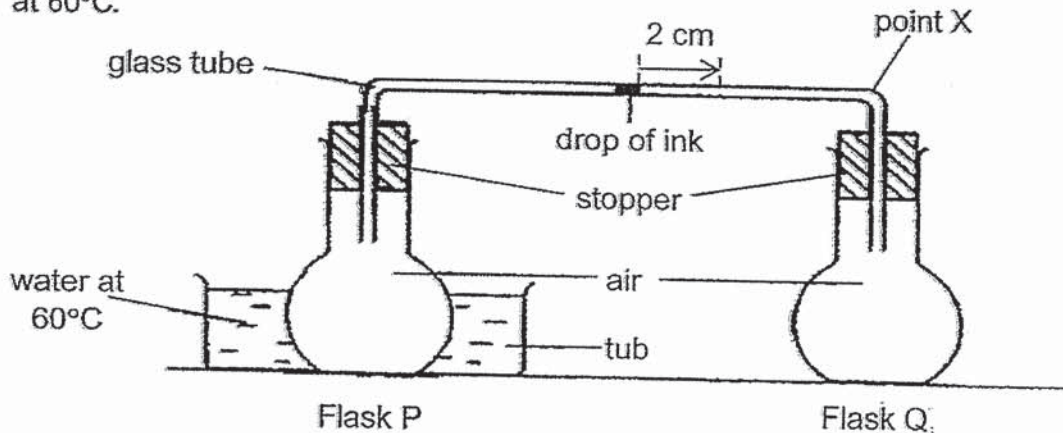

- (a) Alicia observed that after some time, the drop of ink moved a distance of 2 cm towards Flask Q before stopping. Explain why. [1]

Next, Alicia continued another experiment using the same set-up above. She did not make any change to the set-up at Flask P and she did not replace Flask Q. She observed that the drop of ink moved further to point X.

- (b) Explain what Alicia could have done to Flask Q. [1]

(Continue from Question 41)

Alicia then conducted another experiment in a room with a constant temperature of 28°C as shown below. She wrapped two identical conical flasks in set-ups S and T with two identical pieces of cloths. The cloth in set-up S had been soaked in hot water and the cloth in set-up T had been soaked in iced water.

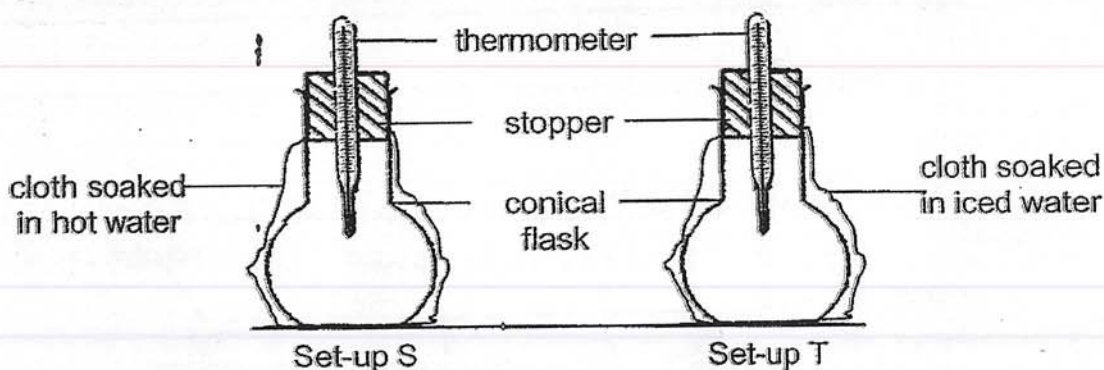

She recorded the change in temperature of the air in both set-ups S and T after 30 minutes as shown in the table below.

Set-up	Temperature of air in the conical flask ($^{\circ}\text{C}$)	
	Start of experiment	After 30 minutes
S	28	30
T	28	<input type="text"/>

(c)(i) Fill in the table to predict the temperature of air in Set-up T after 30 minutes. [1]

(c)(ii) Explain your answer in (c)(i). [1]

(c)(iii) What is the temperature of the air in both set-ups after 1 day? [1]

~ END OF BOOKLET B ~

**Nanyang Primary School
P4 SCIENCE SA2 2019**

**Suggested Answer Key
Section A**

1	2	11	2	21	1
2	3	12	4	22	3
3	3	13	1	23	3
4	1	14	3	24	4
5	2	15	1	25	2
6	3	16	3	26	3
7	2	17	4	27	1
8	3	18	3	28	4
9	4	19	3		
10	3	20	4		

Section B

Qn No	Acceptable Answers
29i.	leaf/leaves
29ii.	roots
30a.	force or pull
30b.	Magnetic
31.	Tick: lit candle and Sun
32.	Faster better
33a.	Circle 'is heavier than'
33b.	Circle 'has the same mass as'
34(a)	Plant X reproduces by seeds and Plant Y reproduces by spores
(b)	The strong stem holds the leaves upright so that the leaves can get sunlight to make food.
(c)	Flowering: plant X non-flowering: Plant Y
(d)	Moss/ferns
a)(i)	moist skin
(ii)	Scales
(b)(i)	To protect the animals/to keep them warm
(b)(ii)	Give birth to young alive/suckle their young
(c)	Reptile
36(a)	(i) Organ C (ii) small intestine
36(b)(i)	Organ A: Food is transported to the stomach.
36(b)(ii)	Organ B: Food is further digested in the stomach/breaks food down into simpler substances
36(c)	Mouth, stomach, small intestine
37a.	Fungi

37b.	P feeds on the bread. P feeds on living things, dead or alive.	
37c.	warmth	✓
	sunlight	
	water	✓
	wind	
38a(i)	The young of both animals do not resemble their adults. Both have an egg stage.	
38a(ii).	The frog has <u>3 stages</u> in its life cycle but the butterfly has <u>4 stages</u> in its life cycle. OR The butterfly's life cycle is entirely on land but the frog's life cycle is partly in water and partly on land.	
38b(i)	<pre> graph LR egg[egg] --> nymph[nymph] nymph --> adult[adult] adult --> egg </pre>	
38b(ii)	The young of the frog does not resemble its adult but the young of the cockroach resembles its adult. The adult frog lives in both land and water but the adult cockroach lives on land.	
38b(iii)	To ensure the survival/continuity of the species /of its kind.	
39a.	The like poles of magnet B and C are facing each other so they repelled each other.	
39b.	Flip magnet C over	
39c.	2	
40a.	L, K, M	
40b.	L: 15cm ³ M: 10cm ³	
40c.	Objects L and M occupy space/have definite volumes/shapes.	
40d.	Object L has a smaller mass but a greater volume than object M or Object M has a greater mass but a smaller volume than Object M.	
41(a)	The air in Flask P gained heat from the hot water and expanded, thus pushing the drop of ink towards Flask Q.	
41(b)	Place Flask Q in a container/box of ice/cold water.	
41(c)(i)	Temperature must be lower than 28°C but more than 0°C.	
41(c)(ii)	The air in the set-up T lost heat to (the container) and the cloth.	
41(c)(iii)	28°C or same temperature as room temperature.	

END.