



RAFFLES GIRLS' PRIMARY SCHOOL
SEMESTRAL ASSESSMENT (1)
2019

Section A	56
Section B	44
Your score out of 100%	
Parent's signature	

Name : _____ Index No.: _____ Class: P4 _____ Date: _____

15 May 2019

SCIENCE

ATT: 1 h 45 min

SECTION A (28 x 2 marks)

For each question from 1 to 28, four options are given. One of them is the correct answer. Make your choice (1, 2, 3 or 4). Shade the correct oval (1, 2, 3 or 4) on the Optical Answer Sheet (OAS) provided.

1. Jane approached a pigeon and it flew away once she moved nearer to it.
Which characteristic of living thing did the pigeon show?

Living things _____.

- (1) grow
- (2) can make its own food
- (3) need air, food and water to survive
- (4) respond to changes in its surroundings



2. Animal X has the following characteristics:

- It has wings.
- It has two legs.
- It has a body covering of feathers.

Which animal group does animal X belong to?

- (1) Birds
- (2) Insects
- (3) Reptiles
- (4) Amphibians

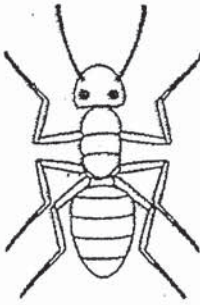
3. David classified four animals as shown in the diagram below.

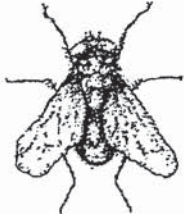
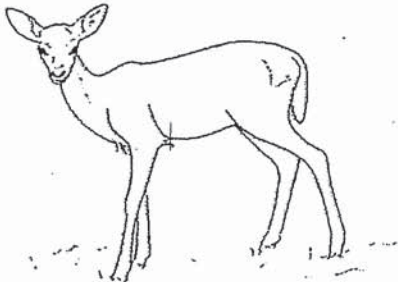
Group P	Group Q
	
	

He classified the animals according to the _____.

- (1) way it moves
- (2) number of legs
- (3) number of mouths
- (4) type of outer covering

4. The classification chart shows how some living things are classified.

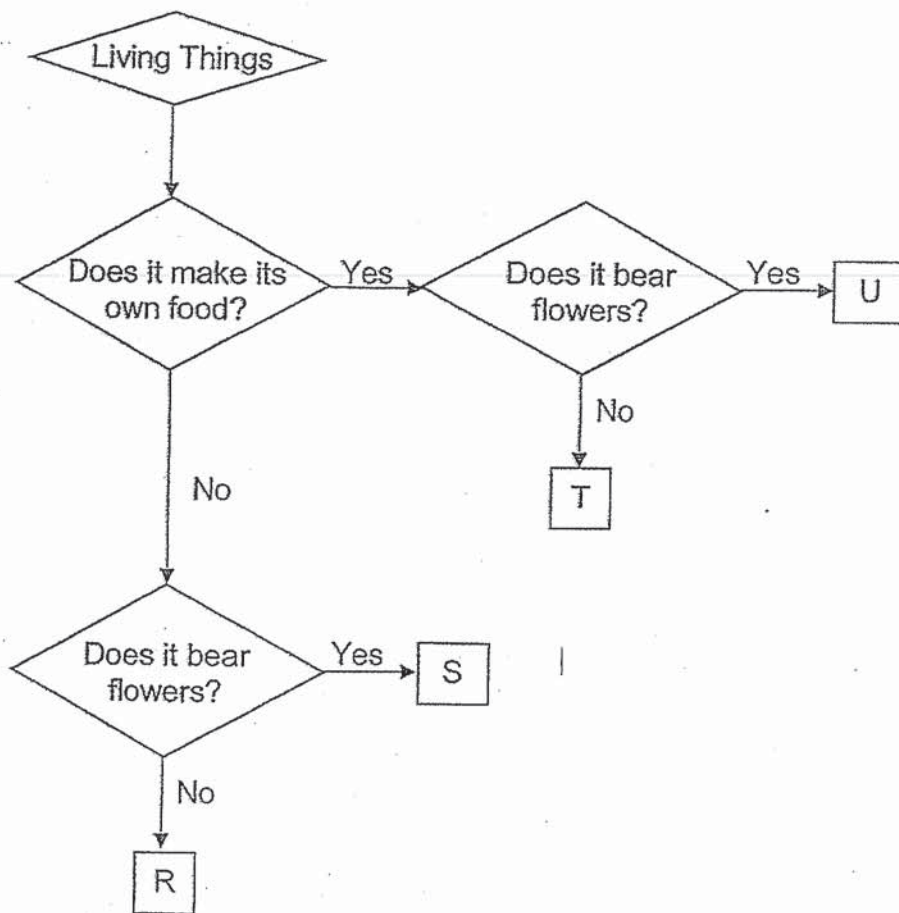

Which one of the following living things represents a bird's nest fern?

- (1) R
 - (2) S
 - (3) T
 - (4) U
5. Which of the following statements describe a fungus?

- A It makes its own food.
 - B It reproduces by spores.
 - C It responds to changes around them.
 - D It needs air, food and water to survive.
- (1) C and D only
 - (2) A, C and D only
 - (3) B, C and D only
 - (4) A, B, C and D

6. Which one of the following life cycles is the correct representation of the life cycle of a chicken?

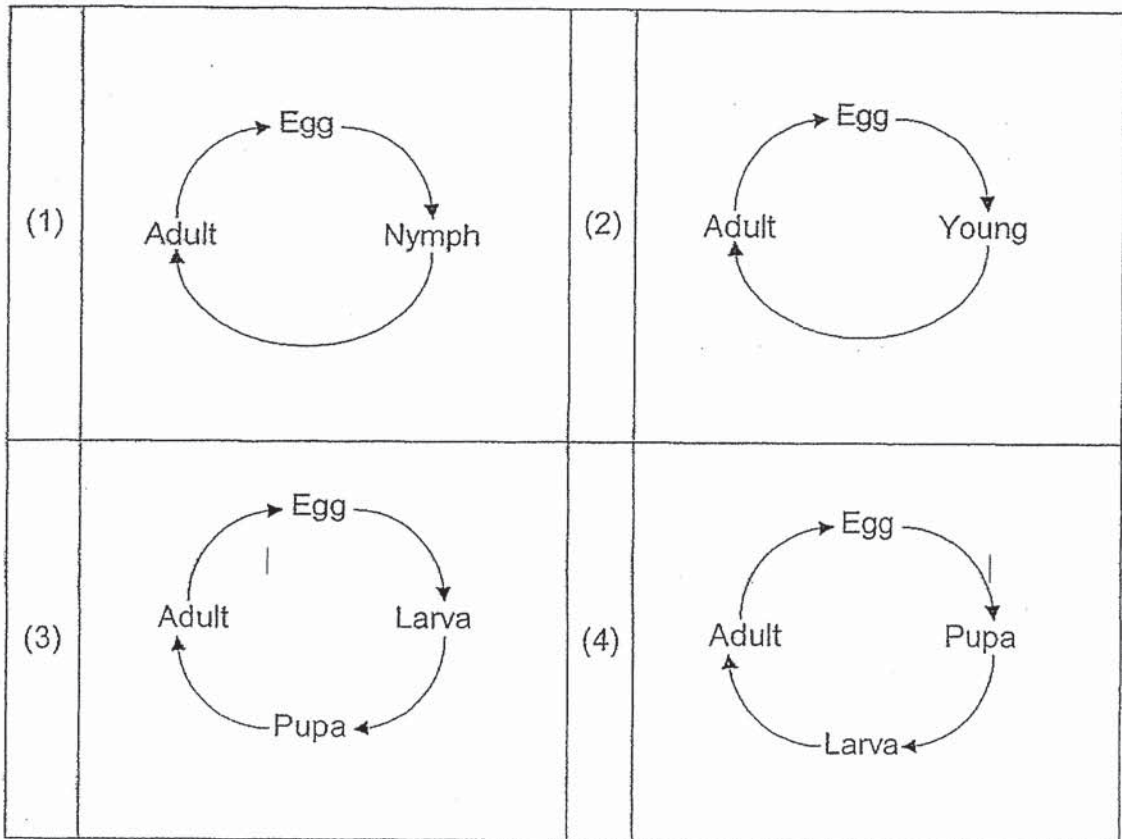

7. The graph below shows the number of days in each stage of the life cycle of organism A.

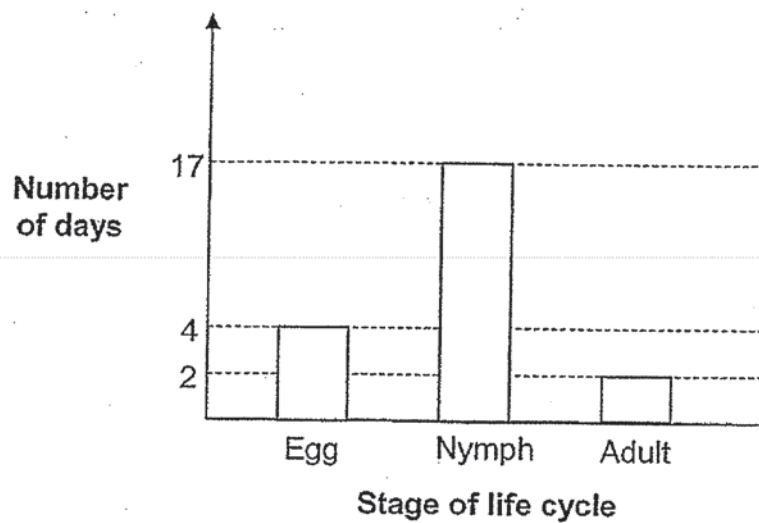

Based on the graph above, which of these statements about organism A is correct?

- (1) Organism A has a four-stage life cycle.
- (2) Organism A spends most of its life as an adult.
- (3) Organism A hatches two days after the egg is laid.
- (4) Organism A becomes an adult seventeen days after hatching.

8. The diagram below shows a picture of a jackfruit tree.

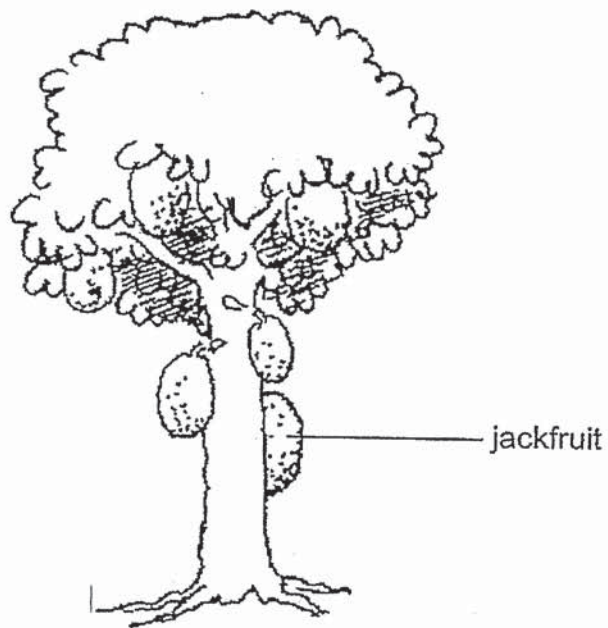

At what stage of development is the jackfruit tree in?

- (1) seed
- (2) seedling
- (3) adult plant
- (4) young plant

9. An experiment was conducted to find out how the temperature of the surrounding air would affect the time taken for a seed to germinate. The graph below shows the result of the experiment.

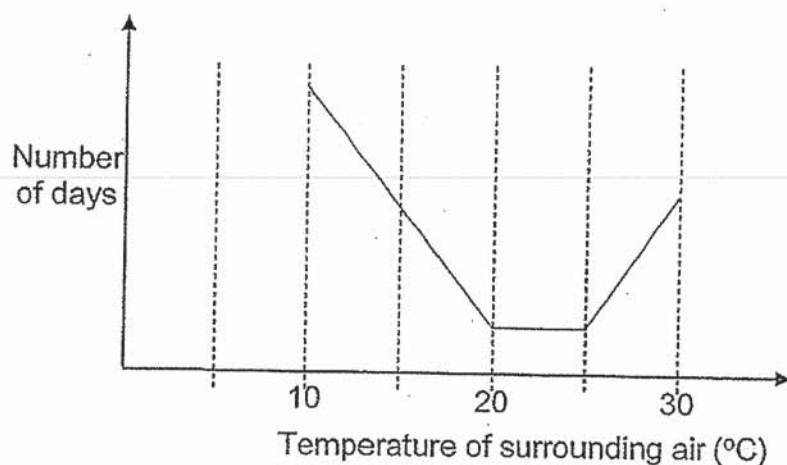

Another experiment was conducted to find out how the amount of water in the surrounding affects the time taken for a seed to germinate. The graph below shows the result of the experiment.

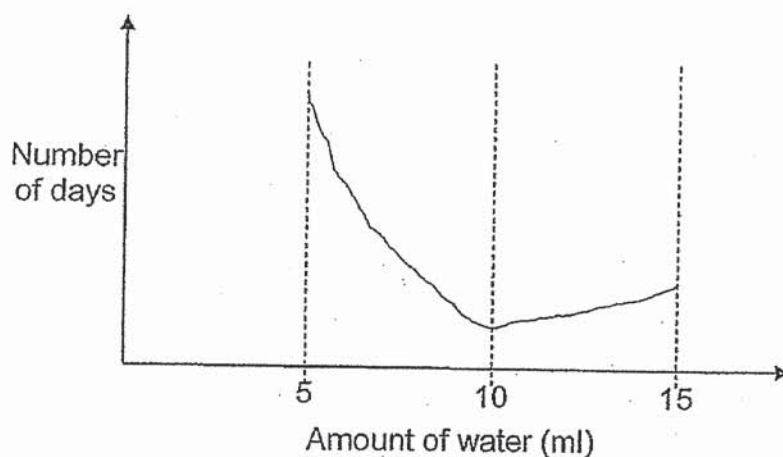

Based on the results of the experiments, which of the following shows the best conditions for the seed to germinate the fastest?

	Temperature of the surrounding air (°C)	Amount of water (ml)
(1)	10	5
(2)	20	10
(3)	25	15
(4)	30	15

10. The diagram below shows a boy kicking a ball.

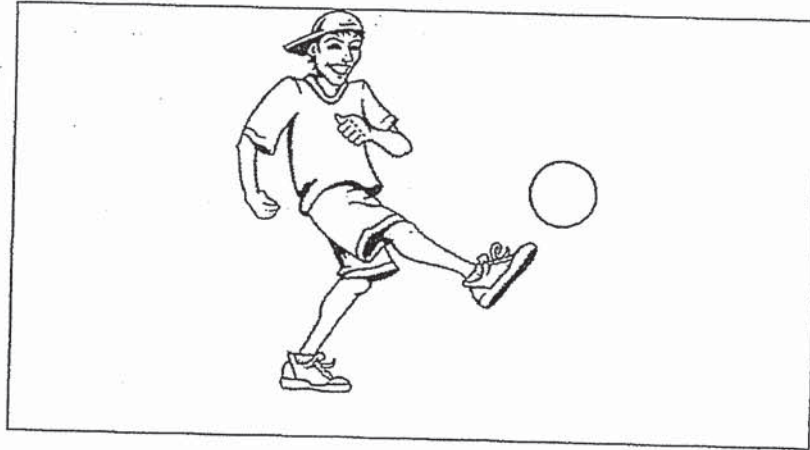

Which pair of the body systems are directly involved in carrying out the movement of his legs?

- (1) Muscular system and skeletal system
 - (2) Circulatory system and skeletal system
 - (3) Respiratory system and skeletal system
 - (4) Circulatory system and muscular system
11. Which of the following statements is correct about the gullet?
- (1) It is connected to the small intestine.
 - (2) It absorbs nutrients into the bloodstream.
 - (3) It transports chewed food into the stomach.
 - (4) It secretes digestive juices to help digest the food.

12. The table below shows the amount of digested food at the end of the digestion process in the different parts of the human digestive system.

Part of the human digestive system	Amount of digested food (g)
A	0
B	50
C	200
D	250

Which part of the digestive system is likely to be the large intestine?

- (1) A
 (2) B
 (3) C
 (4) D
13. Study the chart on human systems below.

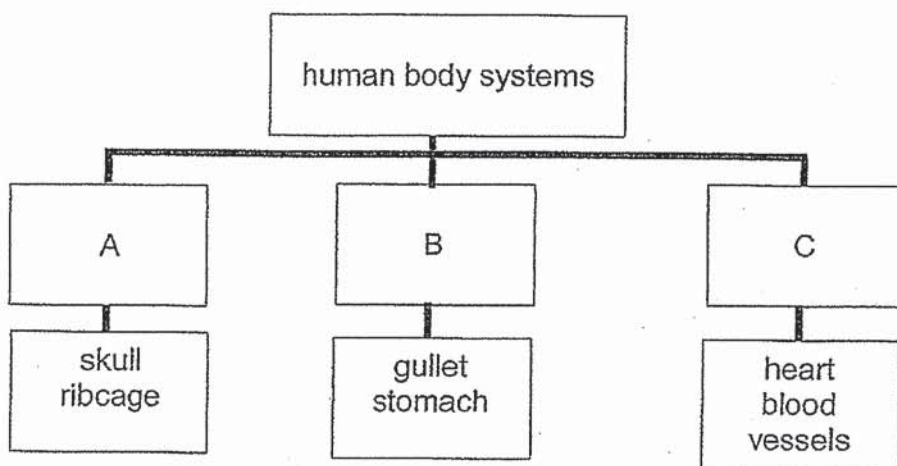

Which of the following options are suitable headings for A, B and C?

	A	B	C
(1)	Circulatory	Respiratory	Digestive
(2)	Skeletal	Digestive	Respiratory
(3)	Digestive	Circulatory	Respiratory
(4)	Skeletal	Digestive	Circulatory

14. Which of the following statements state the functions of a stem?

- A Provides support for the plant.
- B Hold the plant firmly to the ground.
- C Transports food to other parts of the plant.
- D Transports water to other parts of the plant.

- (1) A and C only
- (2) B and C only
- (3) B and D only
- (4) A, C and D only

15. Study the diagram below carefully.

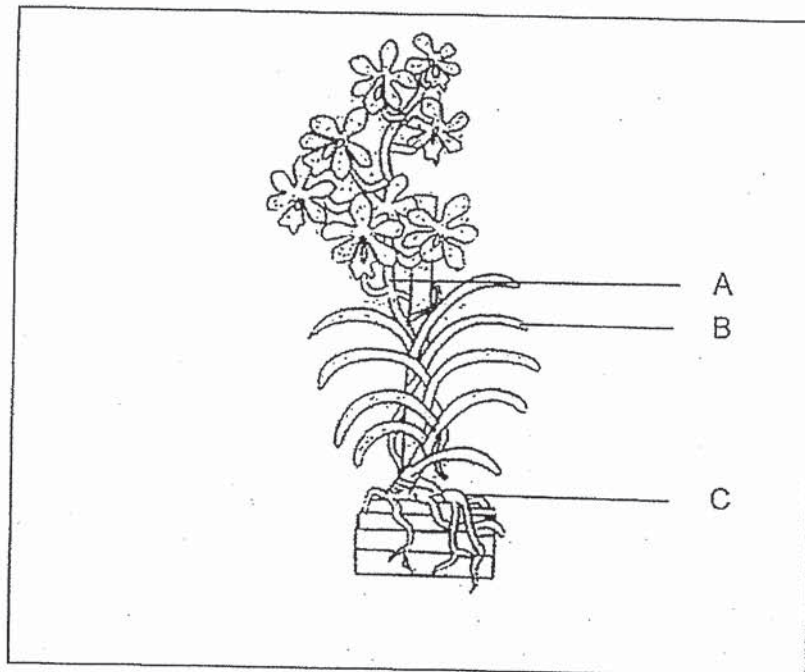

Which of the options below matches the parts of the plant labelled above?

	A	B	C
(1)	Leaf	Stem	Roots
(2)	Flower	Leaf	Stem
(3)	Stem	Leaf	Roots
(4)	Leaf	Flower	Stem

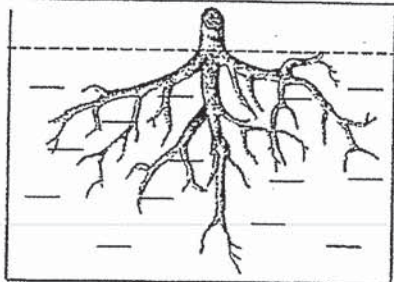
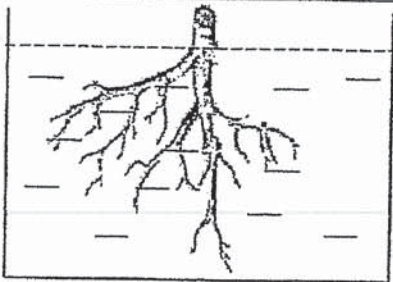
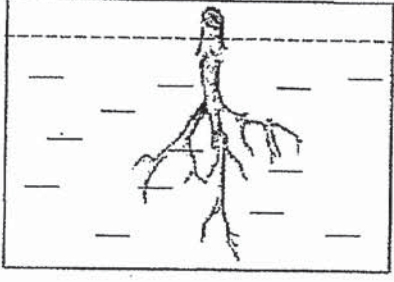
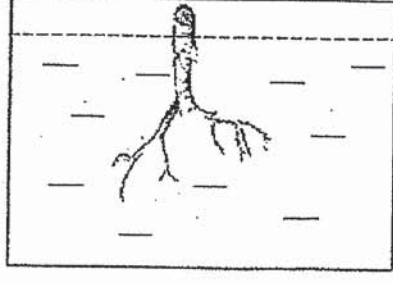

16. The table below shows the roots of four plants planted in identical beakers, with the same amount of water.

	
Beaker A	Beaker B
	
Beaker C	Beaker D

Arrange from the highest to the lowest, according to the water level left in each beaker after one week.

- (1) A,B,C,D
- (2) A,C,B,D
- (3) D,B,C,A
- (4) D,C,B,A

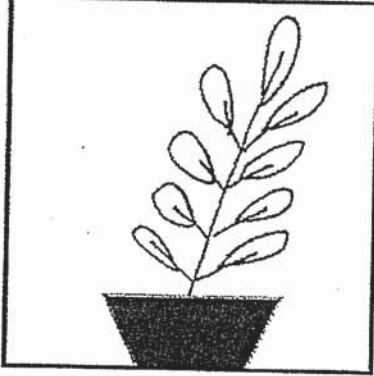
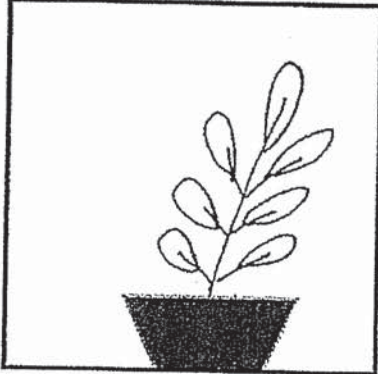
17. The table below shows four similar plants placed in identical pots. Jason wanted to find out if light is necessary for the plants to make food.

	 black box
Plant A placed in the garden	Plant B placed in the garden
 black box	
Plant C placed in the garden	Plant D placed in the garden

Which pair of plants should he use to ensure a fair test being carried out?

- (1) A and B only
- (2) A and C only
- (3) B and C only
- (4) C and D only

18. Chloe had three sheets, A, B, and C, made of different materials. She observed that when she placed all three sheets as shown below, she could not see the rubber duck.

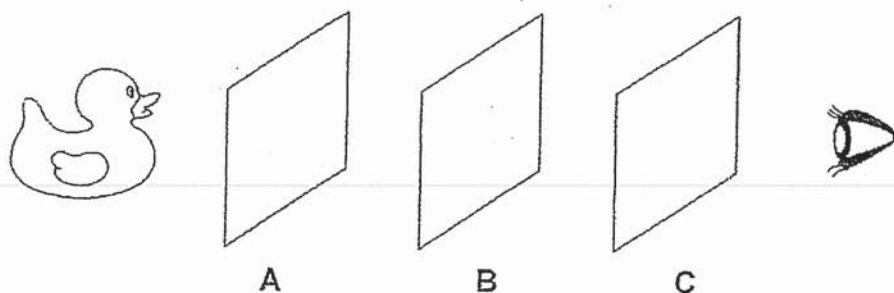

However, if she placed sheets A and C together as shown below, she could see the rubber duck.

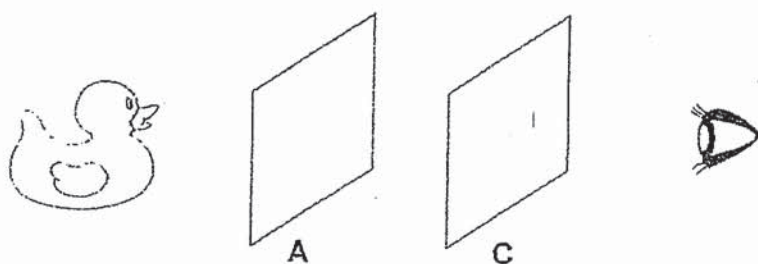

Based on her observations, which of the following statements is **correct**?

- (1) Sheet B allows some light to pass through.
- (2) Sheet C does not allow light to pass through.
- (3) Sheets A and C allow light to pass through them.
- (4) Sheets A, B and C allow some light to pass through them.

19. Summer set up an experiment as shown below to test the absorbency of three different materials, D, E and F.

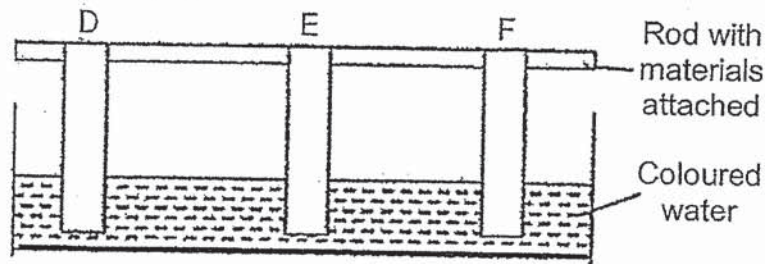

After an hour, Summer observed the following results.

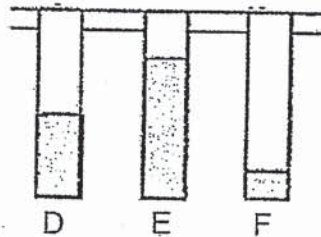

Which of the following options shows the **correct** arrangement of the materials according to its absorbency?

	Most absorbent \longrightarrow Least absorbent		
(1)	D	F	E
(2)	F	D	E
(3)	E	F	D
(4)	E	D	F

20. Which one of the following **correctly** describes a matter?

- (1) Anything that has definite size and shape.
- (2) Anything that has definite volume and mass.
- (3) Anything that has mass and occupies space.
- (4) Anything that has definite volume and shape.

21. Belinda conducted an experiment using two identical syringes. Both syringes A and B were initially filled with 20 cm³ of substance X and Y respectively. She compressed both syringes and the results are as show in the table below.

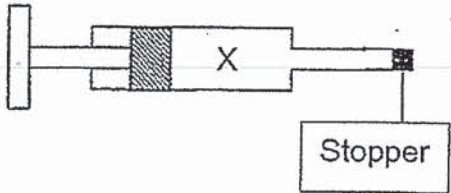
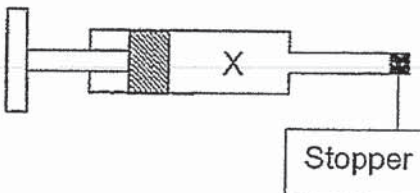
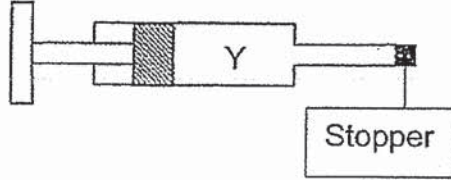
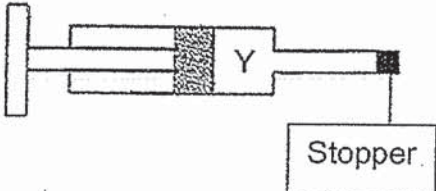
Before pushing the plunger	After pushing the plunger
	
	

Which of the following can she conclude from her experiment?

- (1) Substance X has a fixed volume but not substance Y.
- (2) Substance X has a definite mass but not substance Y.
- (3) Substance X can be compressed but not substance Y.
- (4) Substance X has a definite shape but not substance Y.

22. Jenny poured 50 cm^3 of water into a beaker containing 50 cm^3 of sand as shown in the diagram below.

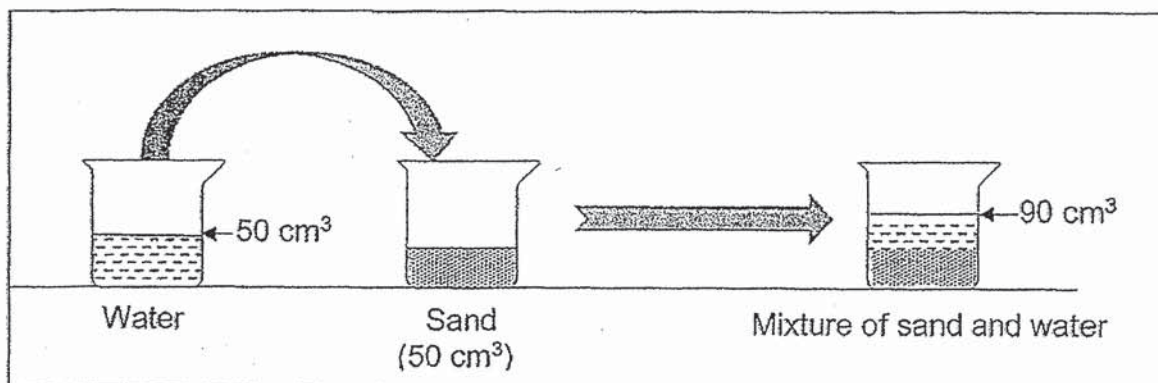

Based on the information above, which of the following could she conclude from her experiment?

- A Sand had no fixed volume.
- B Water had no fixed shape.
- C Water occupied the space in between the sand.

- (1) A only
- (2) A and B only
- (3) B and C only
- (4) A, B and C

23. A ping pong ball was placed into an empty cup. The cup was later inverted and lowered into a basin of water as shown below.

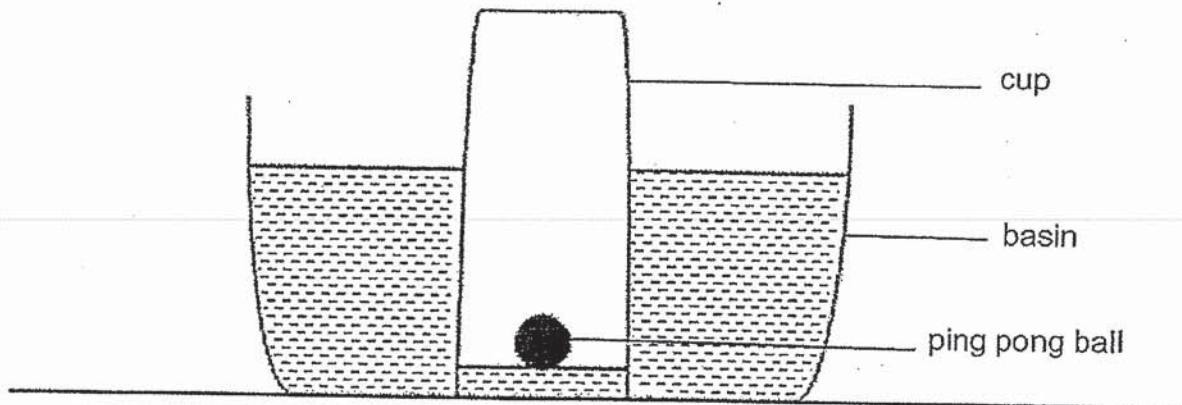

What could you do to make the ping pong ball rise to a higher position?

- (1) Use a bigger basin
- (2) Use a smaller basin
- (3) Add more water to the basin
- (4) Poke a hole at the base of the cup

24. Jason set up an experiment as shown below.

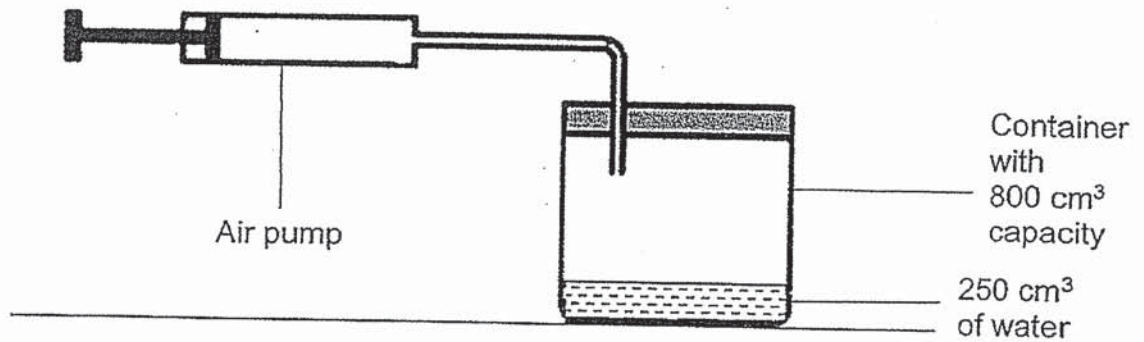



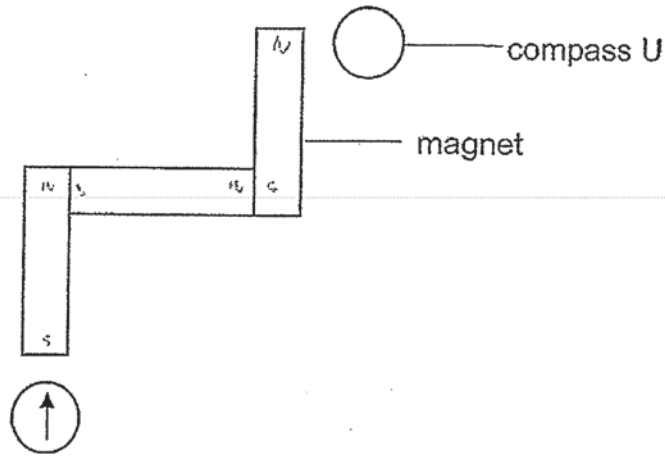

Jason then pumps in an additional 900 cm³ of air into the container.
What is the final volume of air and water in the container?

	Volume of water (cm ³)	Volume of air (cm ³)
(1)	0	800
(2)	0	900
(3)	250	550
(4)	250	1700

25. Janet set up three bar magnets as shown in the diagram below. She brought two compasses towards the ends of the two bar magnets as shown in the diagram below.



Which one of the following diagrams shows the correct direction that compass U would be pointing to?

(1)		(2)	
(3)		(4)	

26. Four identical bars, W, X, Y and Z, were magnetised using the stroke method as shown in the diagram below and given to four students.

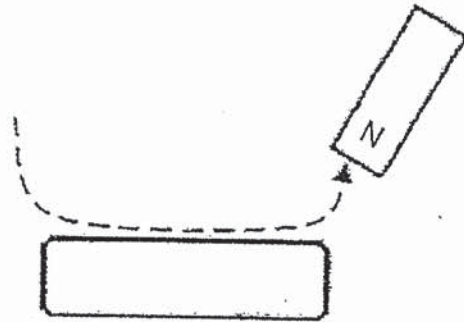

Two of the four students made the following changes to their bars:

Amy : Strike the bar with a hammer for 50 times.

Benny: Stroke the bar with the N-pole of the magnet in the same direction for 50 times.

The four bars were then used to pick up pins from a tray. The result of the experiment is shown in the table below.

Bars	Number of pins attracted by the bar at first	Number of pins attracted by the bar at the end of the experiment
W	20	3
X	20	20
Y	20	35
Z	20	19

Which of the following magnets belong to Amy and Benny respectively?

	Amy	Benny
(1)	W	Y
(2)	Z	X
(3)	X	Y
(4)	Y	W

27. The diagram below shows electromagnet A.

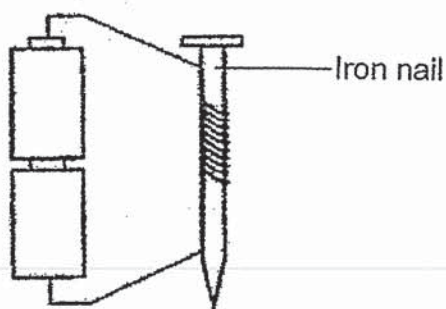

Three other electromagnets were set up with different numbers of coil around the nail and different number of batteries as shown in the table below.

Electromagnet	Number of batteries	Number of coils around the iron nails
A	2	10
B	1	5
C	2	20
D	2	10

Which of the following shows the **correct** arrangement of the electromagnet according to its strength, starting from the weakest?

	Weakest → Strongest			
(1)	A	B	C	D
(2)	B	D	A	C
(3)	B	A	D	C
(4)	D	A	B	C

28. The diagram below shows a separation machine used in a factory.

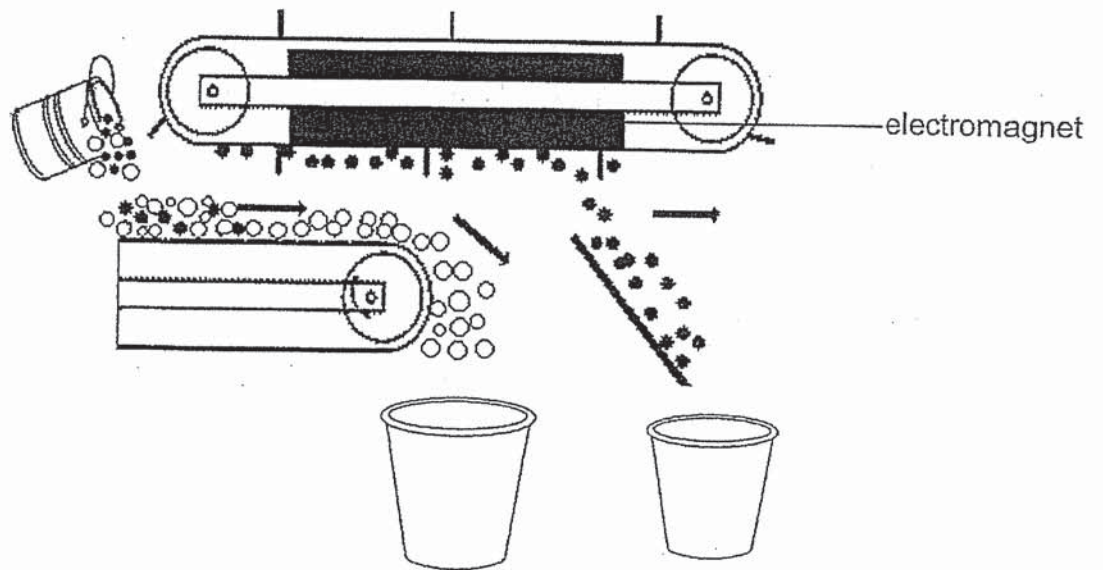

Which of the following mixture can the above machine separate?

- (1) Iron nails, steel clips
- (2) Nickel parts, iron filing
- (3) Iron filing, wood shavings
- (4) Cotton wool, copper wires

Name : _____ Index No: _____ Class: P4 _____

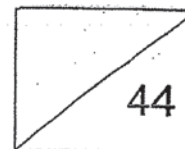

SECTION B (44 marks)

For questions 29 to 41, write your answers clearly in the spaces provided. The number of marks available is shown in brackets [] at the end of each question or part question.

29. Organism X is a plant which reproduces by spores. Jenny placed organism X in a dark room and watered it every day.

(a) Give a reason why organism X died after a week. [1]

(b) Jenny thinks that organism X is a flowering plant. Do you agree? Give a reason for your answer. [1]

(c) State one difference between a plant and a fungus. [1]

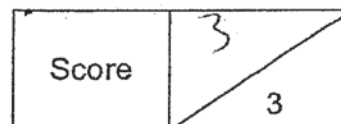

30. The table below shows how four animals are classified.

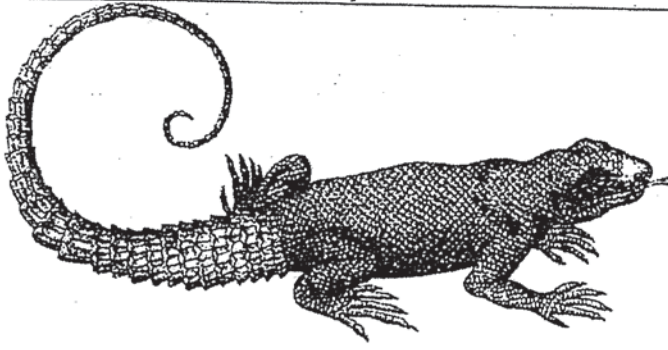
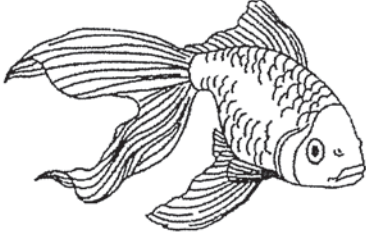
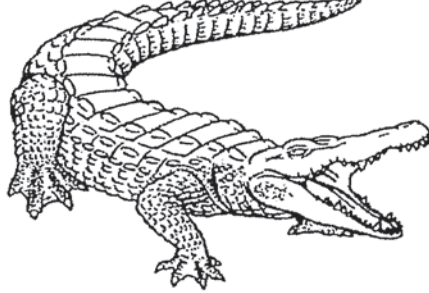
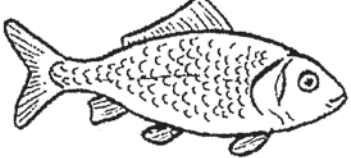
Group X	Group Y
	
	

(a) State a suitable heading for the each of the groups. [1]

Group X : _____

Group Y : _____

(b) Based on your observation, state one similarity between the animals in groups X and Y. [1]

(c) Based on your observation, state one difference between the animals in groups X and Y. [1]

Score	3
-------	---

31. The diagram below shows the life cycle of a mosquito.

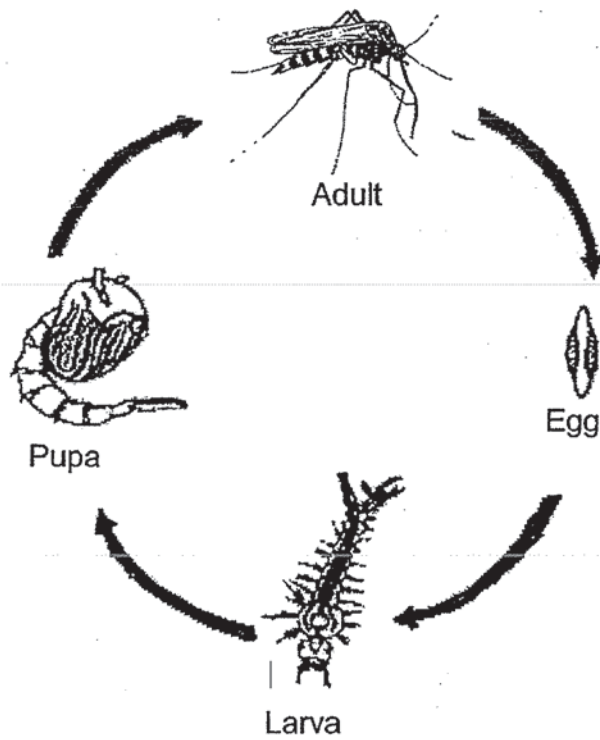

- (a) Based on the diagram above, state one difference between the larva and the adult stage. Do not compare the size and the number of legs. [1]

Continue on next page

Score	/
	1

Continued from previous page

Mr Tan caught some mosquito larvae and observed them over a period of four weeks. He provided the mosquito larvae with enough food and water and made sure that none of them died during his experiment. The graph below shows the number of mosquito larvae over the four weeks.

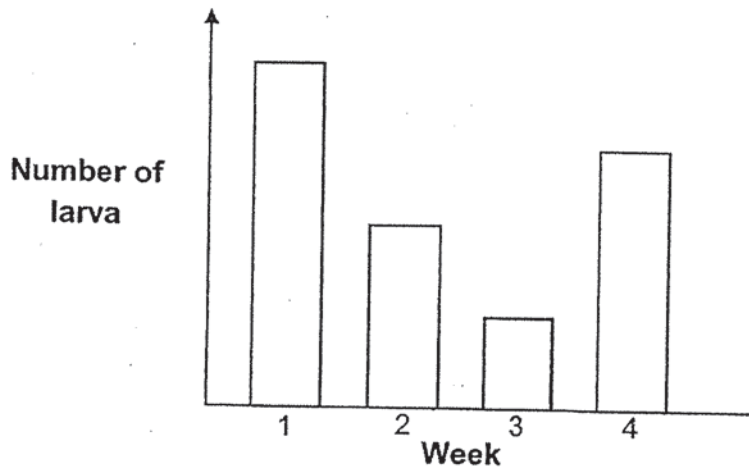

- (b) There was a decrease in the number of mosquito larvae in the container after the first week. Assuming that none of the mosquito larvae died, what could be a possible reason for the decrease in the number of mosquito larvae in the container? [1]

- (c) There was a sudden increase in mosquito larvae in week four. Suggest a possible reason for the increase in the number of mosquito larvae in week four. [1]

Score	2
-------	---

32. The diagram below shows the cross-section of a seed with a marked part A.

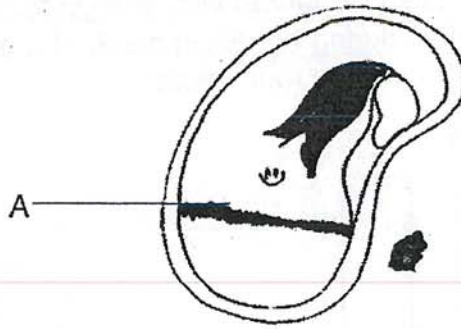

(a) Name part A. [1]

Part A: _____

(b) State the function of part A. [1]

(c) The diagram below shows the different stages of development of a plant.

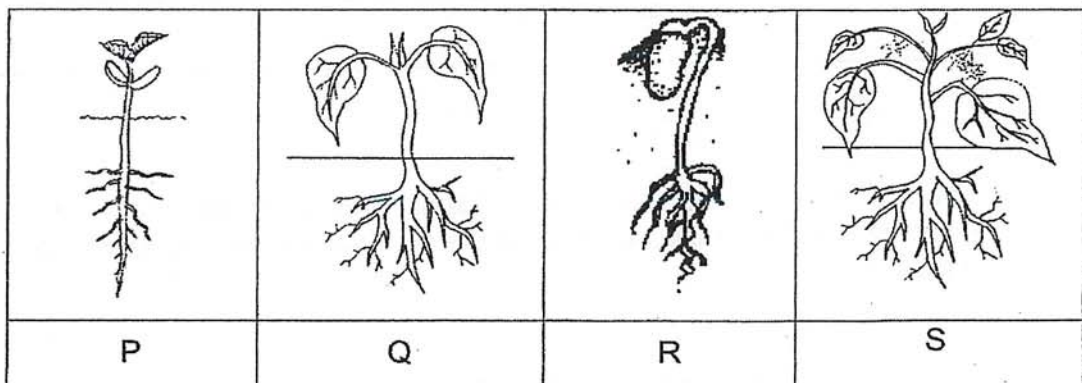

Based on the diagram above, at which stage(s) of the development of a plant is/are part A of the seed not needed? Give a reason for your answer.

[1]

Continue on next page

27

Score	3
-------	---

2019 P4 Science SA1

Continued from previous page

(d) Using the diagrams in (c); complete the life cycle of a plant. [1]

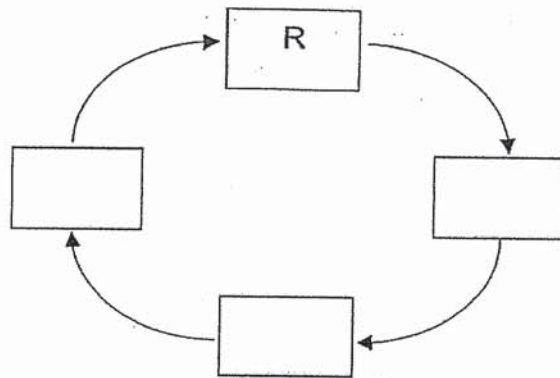

33 (a) Name two functions of the skeletal system. [2]

- (i) _____

- (ii) _____

The diagram below shows the human digestive system.

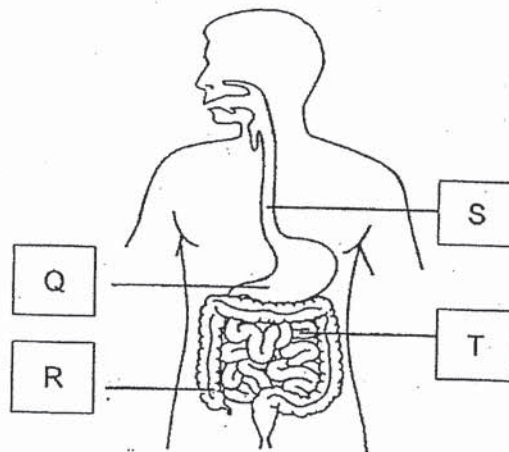

(b) Which parts secrete digestive juices to help digest food? [1]

Score	4
-------	---

2019 P4 Science SA1

34. Elicia learned that the teeth helps to chew food down and breaks them into smaller pieces. Elicia conducted an experiment to determine if the size of the food affected the rate of digestion. There was 200 g of food particles in each flask. The diagrams of the set-ups of the experiment are seen below.

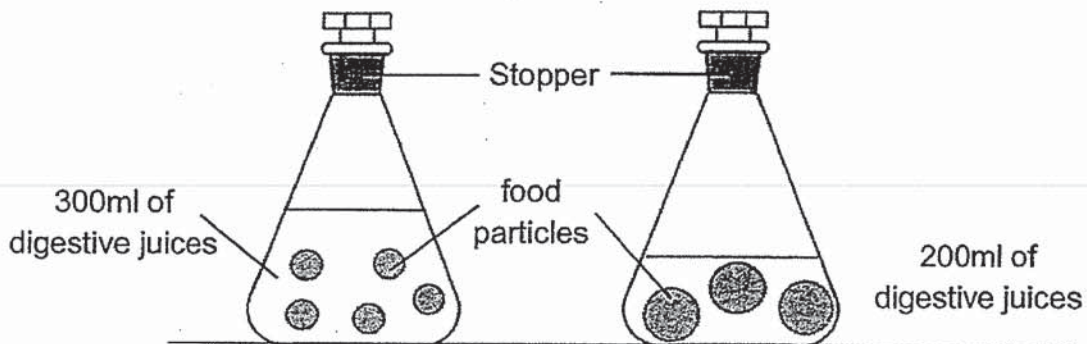

Her teacher commented that her experiment was not a fair one.

- (a) What change should Elicia make in order to conduct a fair experiment? [1]

After Elicia made the change to the experiments as seen in (a) and included two more set-ups to the experiment, she obtained the following results.

- (b) The table below shows the time taken for digestion (min) with differing food size. Fill in the missing blank in the table below. [1]

Food size (cm ³)	Time taken for digestion (min)
1	5
2	9
3	(b) _____
4	20

- (c) What can you conclude about the relationship between food size and the time taken for digestion? [1]

Score	3
-------	---

35. The diagram below shows two plants, A and B.

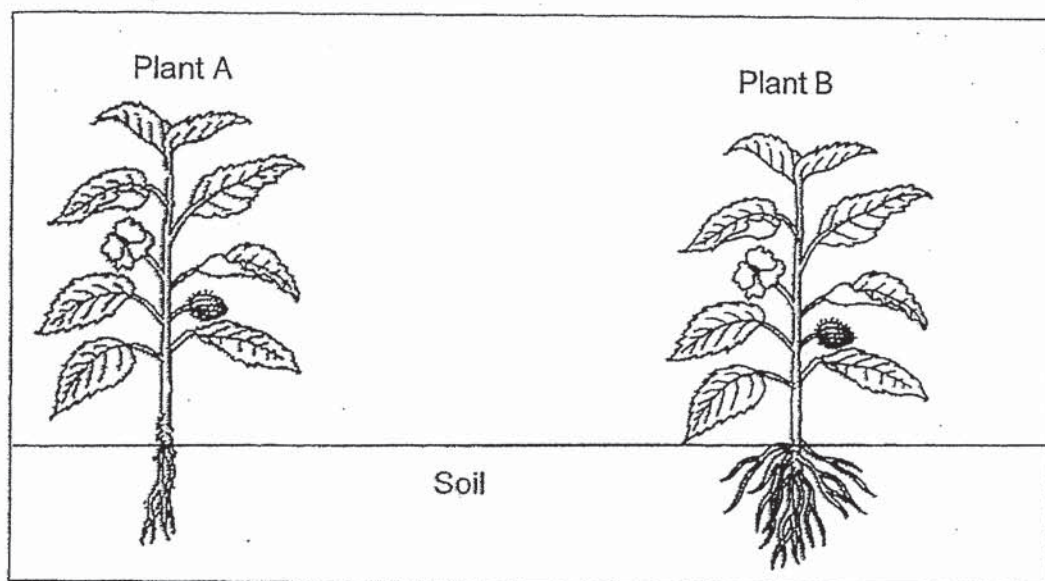

- (a) After a storm, one of the plants was uprooted. Which of the plants would be most likely to be uprooted first? Give a reason for your answer. [1]

- (b) Jason placed the uprooted plant into red coloured water for a week and its leaves turned red. When he cut the stem of the plant, the cross section is as shown below. The shaded sections are red in colour. Name parts (i) and (ii) in the blanks above. [1]

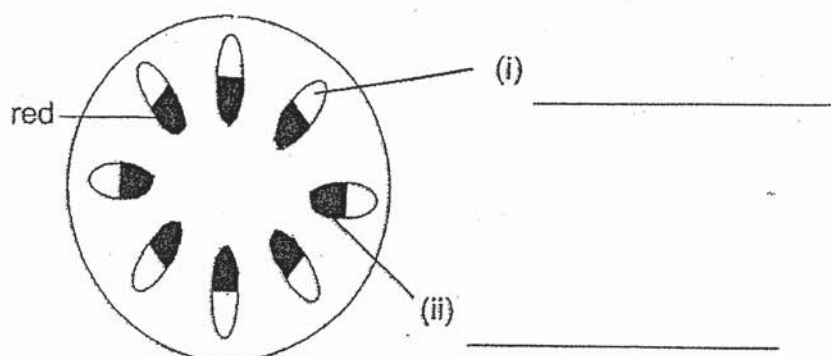

Continue on next page

Score	2
-------	---

Continued from previous page

- (c) In the diagram below, use arrows to indicate how water travels through the plant. [1]

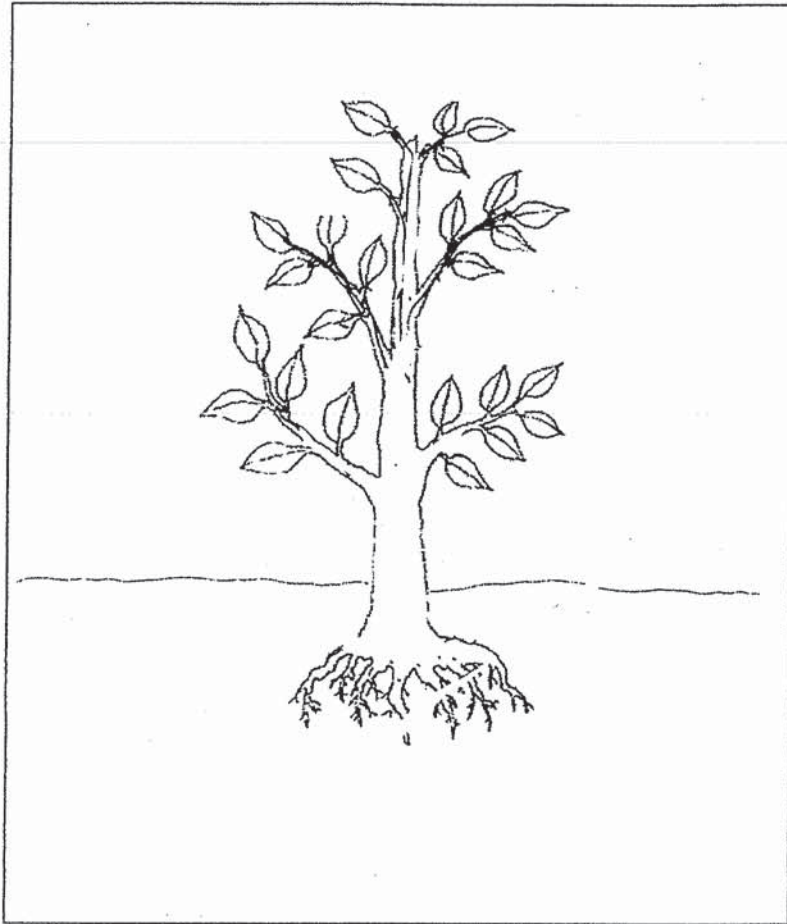

- (d) Explain your answer in (c).

[1]

Score	/
	2

36. Andy carried out an experiment as shown in the diagram below to test the strength of material W. He added weights until the material started to break and recorded the results in the table below.

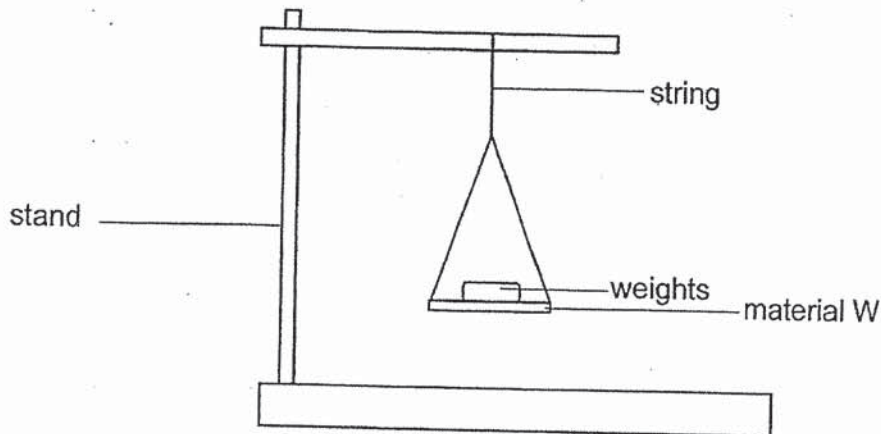

Using the same apparatus, Andy repeated the experiment using materials X, Y and Z.

Material	Mass it held before it started to break (kg)
W	20
X	30
Y	40
Z	50

- (a) Other than the apparatus, state one characteristic of the material that should be kept the same to ensure a fair test. [1]

Continue on next page

Score	1
-------	---

Continued from previous page

Andy then tested the flexibility of materials W, X, Y and Z as shown in the diagram below. He placed the materials 100 cm above ground and hung a 200g-weight onto the material as shown below.

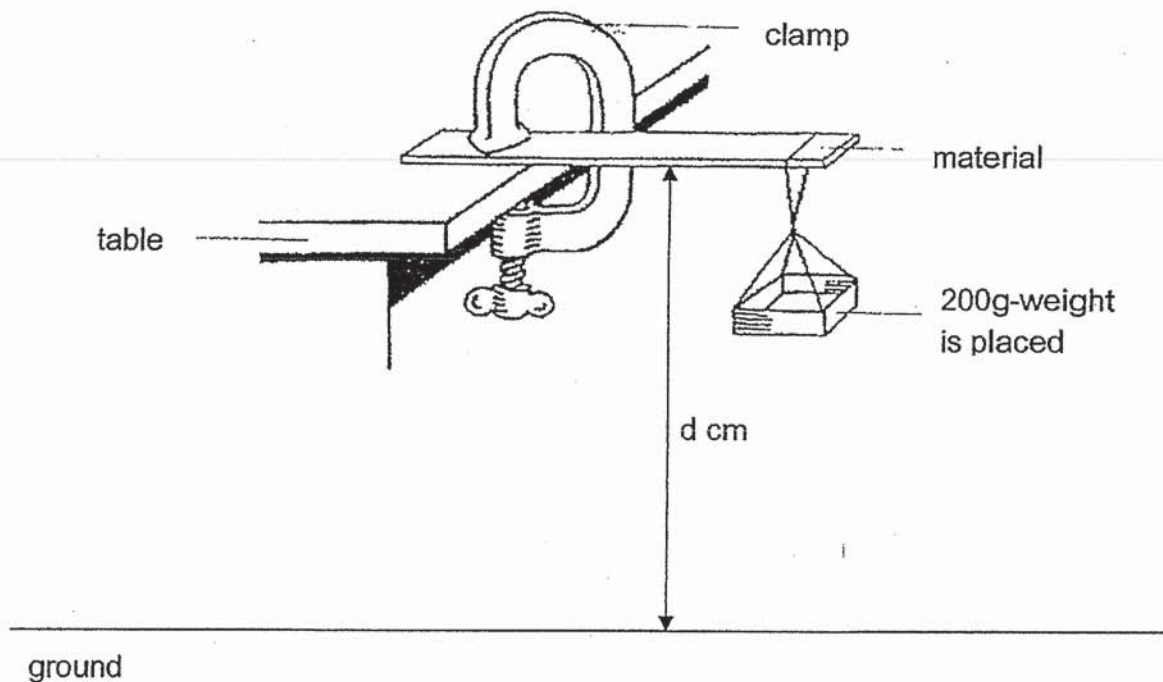

He then measured the distance, d cm, from the ground as shown in the diagram below. The results of his experiment is shown in the table below.

Material	Distance between material and the floor (d cm)
W	100
X	10
Y	50
Z	80

(b) Which one of the materials is the least flexible? Explain your answer. [1]

Continue on next page

Score	1
-------	---

Continued from previous page

Andy wanted to use one of the material to make a diving board as shown in the picture below. The board should be able to carry children up to a mass of 35 kg be able to bend to enable the children to jump off the board.

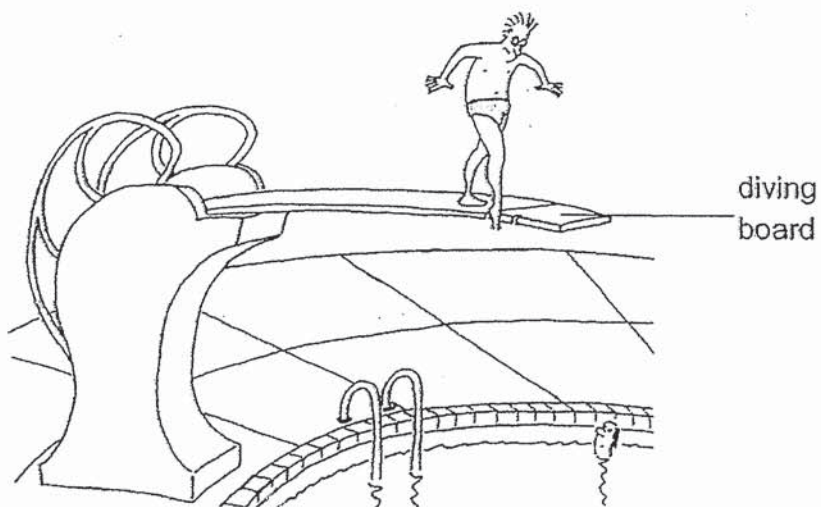

- (c) Which one of the material is most suitable to make the diving board?
Explain your answer. [2]

Score	2
-------	---

37. Three solids, X, Y and Z were placed into a basin of water one at a time.

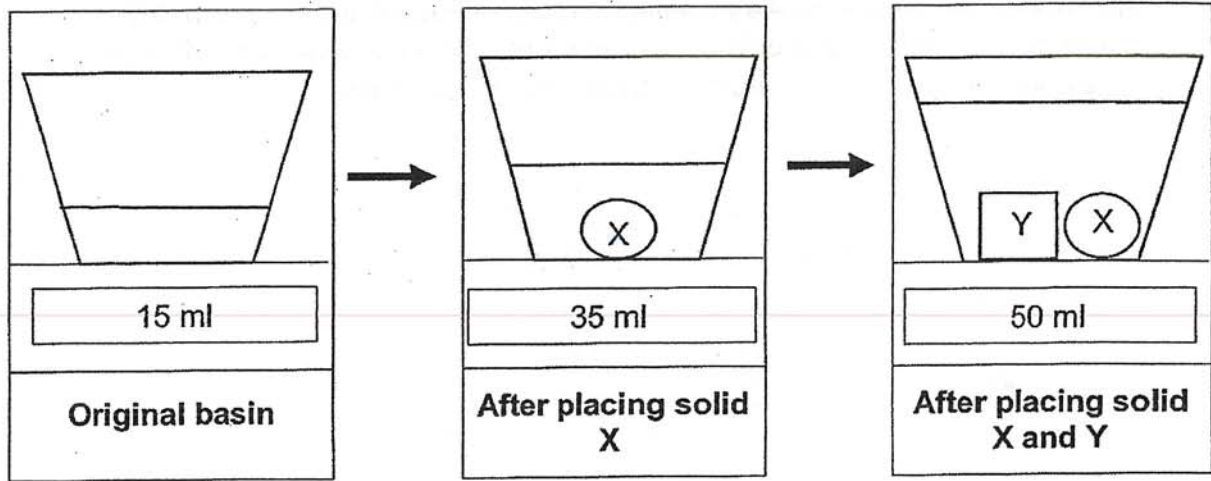

(a) What is the volume of Y? [1]

(b) State the property of the solid based on the information above. [1]

The diagram below shows three possible positions of solid Z.

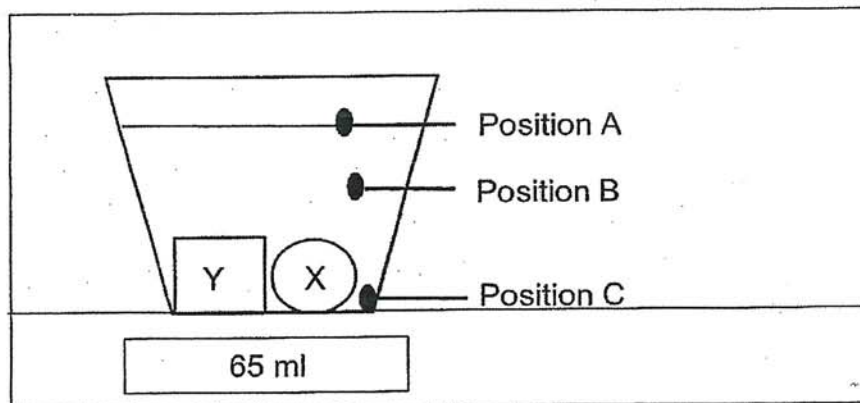

(c) In order to measure the volume of solid Z accurately, where should it be placed in the set-up as shown above (position A, B or C)? [1]

Score	3
-------	---

38. Joseph placed a balloon in two different bottles as seen in the diagram below. He tried to inflate both of them with the same amount of effort. However, he only managed to inflate the balloon in set-up A.

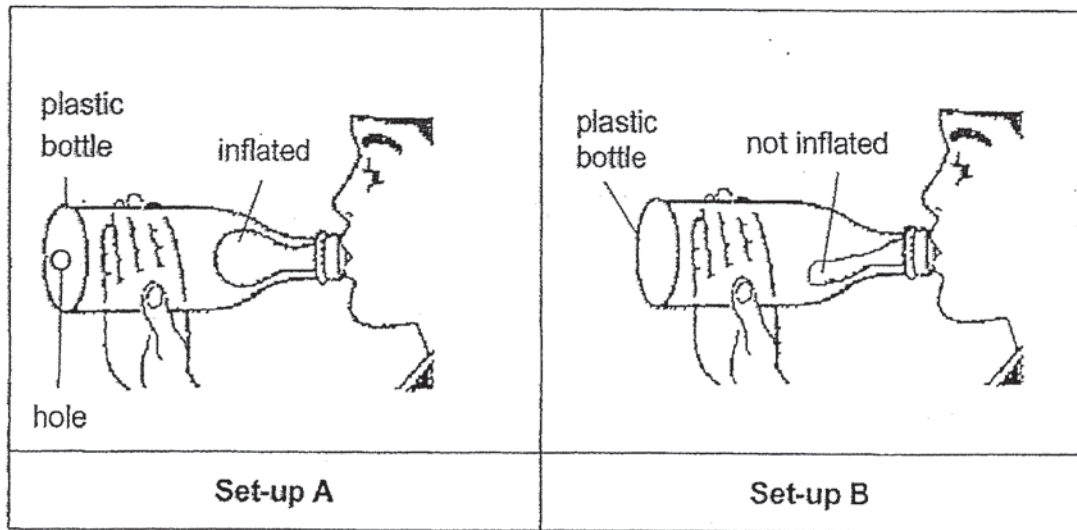

- (a) Explain why Joseph was able to inflate the balloon in set-up A only. [2]

- (b) Without removing or adding any new apparatus, suggest how Joseph could inflate the balloon in set-up B more easily than set-up A. [1]

39. Eight metal balls of the same shape and size were required to balance an inflated rugby ball as seen in the diagram below.

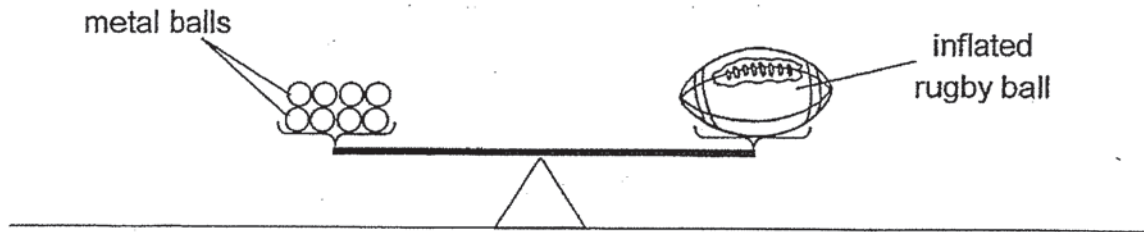

- (a) If more air was pumped into the rugby ball, would more metal balls be required to balance it? Explain your answer. (Assuming that the rugby ball does not burst and its size does not change.) [1]

- (b) Name two properties of air shown in the above experiment. [2]

(i) _____

(ii) _____

Score	3
-------	---

40. Study the diagram below. Four objects P, Q, R and S were hung on balancing beams as shown below.

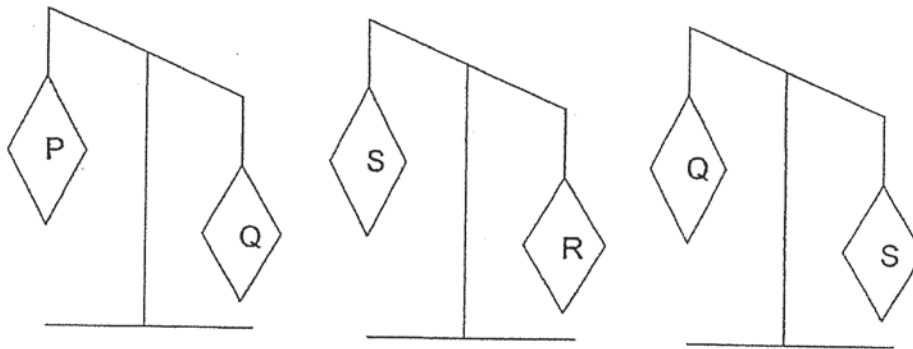

- (a) Based on what you can observe in the diagram above, place a tick (✓) for the correct options in the table below. [3]

	Statements	True	False	Not possible to tell
(i)	Object P has more mass than object S.			
(ii)	Object R has more mass than object Q.			
(iii)	Object Q has a larger volume than Object S.			

Continue on next page

Score	3
-------	---

Continued from previous page

A stone was placed into a measuring cylinder with some water inside as shown in the diagram.

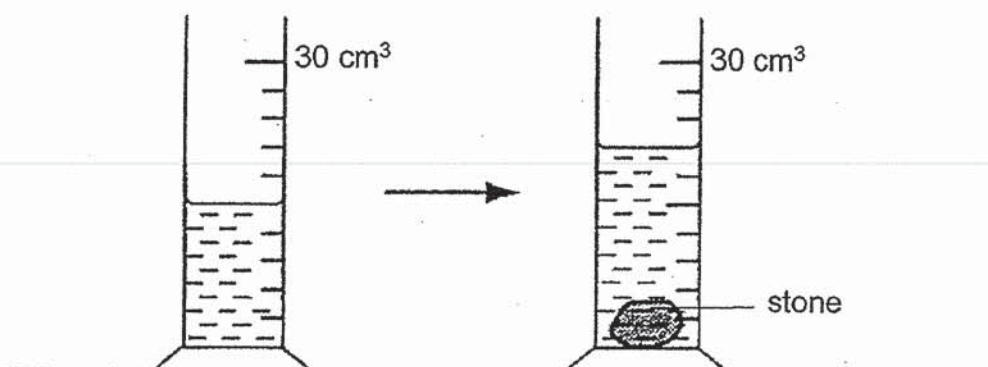

(b) Explain why there is an increase in the water level.

[1]

Score	1
-------	---

41. The diagram below shows an electric bell which made use of an electromagnet.

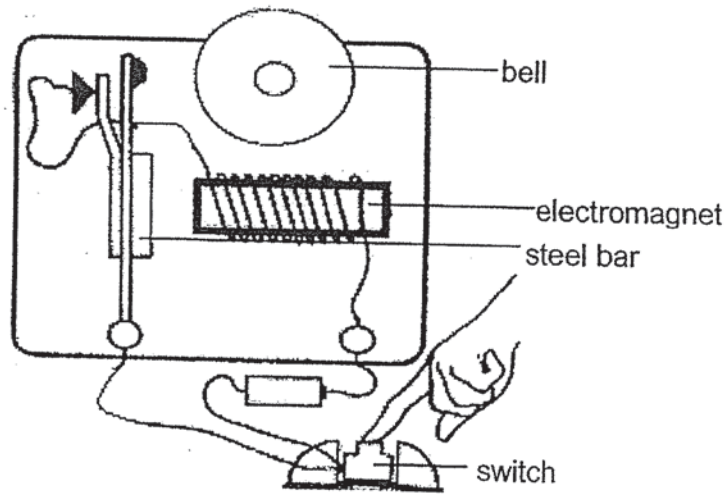

When the switch was activated, the steel bar moved towards the electromagnet as shown in the diagram below and rang the bell.

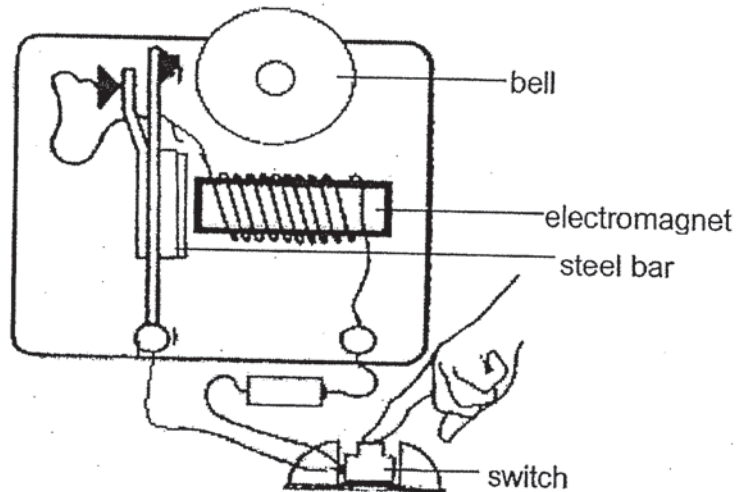

- (a) Explain why the bell was able to ring.

[2]

Continue on next page

Score	2
-------	---

Continued from previous page

The steel bar was then replaced by bar G. When the switch was activated, bar G moved further away from the electromagnet as shown in the diagram below.

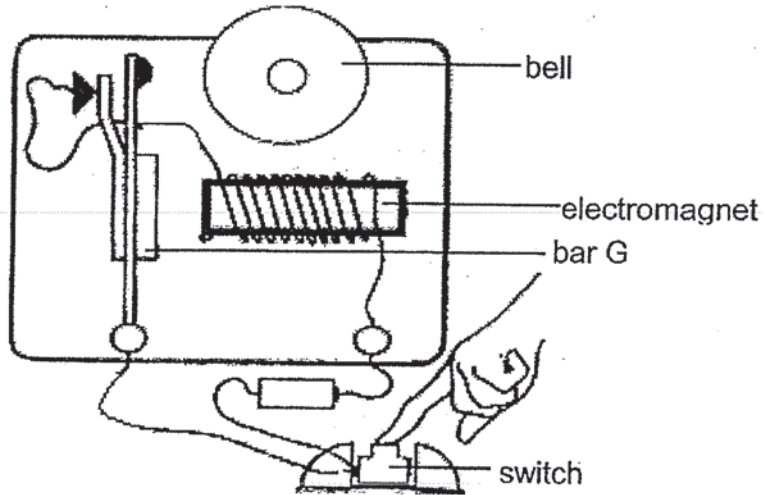

(b) What could be concluded about bar G? Give a reason for your answer.

[2]

End of Paper

Score	2
-------	---

ANSWER KEY

YEAR : 2019
LEVEL : PRIMARY 4
SCHOOL : RAFFLES GIRLS' PRIMARY SCHOOL
SUBJECT : SCIENCE
TERM : SA 1

SECTION A

Q1	4	Q2	1	Q3	2	Q4	3	Q5	3
Q6	2	Q7	4	Q8	3	Q9	2	Q10	1
Q11	3	Q12	1	Q13	4	Q14	4	Q15	3
Q16	4	Q17	1	Q18	3	Q19	4	Q20	3
Q21	1	Q22	3	Q23	4	Q24	3	Q25	4
Q26	1	Q27	2	Q28	3				

SECTION B

29a) There is no sunlight in the dark room and thus X could not trap sunlight to make its own food.

Q29b A flowering plant reproduces by seeds, but X reproduces by spores.

Q29c) A plant makes its own food, while a fungus feeds on living things, dead or alive.

Q30a) Group X: Reptile
Group Y: Fish

Q30b) Both animals in X and Y have scales as outer-body covering.

Q30c) The animals in X have legs while the animals in Y do not.

Q31a) The mosquito has wings in the adult stage but not in the larva stage.

Q31b) Some of the larva had developed into pupa.

Q31c) The pupa that entered the adult stage laid eggs which then hatched and entered the larva stage.

Q32a) Part A: Seed leaf

Q32b) It provides food for the seed.

Q32c) Stages P,Q,S. The plant has leaves which trap sunlight and make food for the plant and hence part A is not needed.

Q32d)

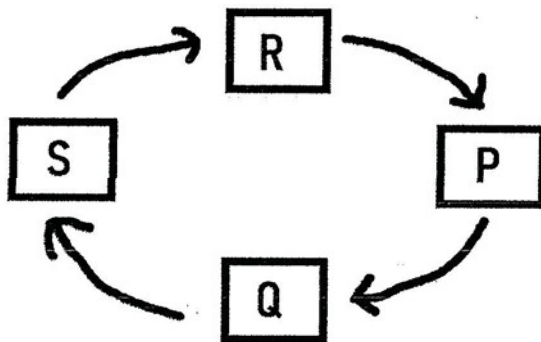

Q33a) i: It gives the body its shape.

ii: It protects organs like the heart and lungs.

Q33b) Q and T

Q34a) Elicia should change the amount of digestive juices in both flasks to the same amount.

Q34b) 14

Q34c) The bigger the size of the food, the longer the time taken for digestion.

Q35a) Plant A. Plant A has lesser roots than Plant B which means Plant A has a higher chance to be uprooted as it has lesser roots to anchor itself to the ground.

Q35b) i: food-carrying tube (Phloem)

ii: water-carrying tube (Xylem)

Q35c) (Draw up arrows from roots to all parts of the plant)

Q35d) The roots will absorb water from the ground. The water will then be transported from the roots to all parts of the plant by the stem.

Q36a) The thickness of the material.

Q36b) W. The distance between W and the floor was the furthest.

Q36c) Material Y. Both Y and Z can withstand more than 35kgs of mass. However, material Y is more flexible than Z, allowing it to bend more.

Q37a) 15ml

Q37b) Solids have a definite volume.

Q37c)

Q38a) The plastic bottle in A had a hole which allowed air to escape. Joseph was able to inflate the balloon in A as the balloon occupied the space previously occupied by the air.

Q38b) Cut bigger holes in the bottle of B.

39a) Yes. The mass of air in the rugby ball has increased although the maximum volume and size are unchanged.

39b) i: Air has mass

ii: Air can be compressed

40a) i: False ii: True iii: Not possible to tell

40b) The stone takes up space in the water as it is matter.

41a) When the switch was activated, the electromagnet attracted the steel bar which is a magnetic material. That causes the bell to ring.

41b) Bar G is a magnet. The like poles of the electromagnet and G were facing each other and repelled.

4.

END